

800 V and 600 V, 25 A standard Triacs in RD91 package

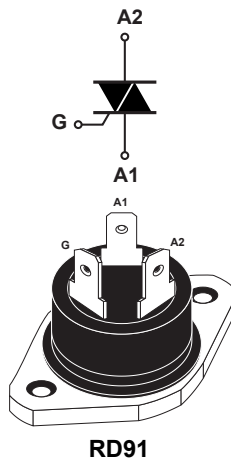

Features

- High current Triac
- Low thermal resistance with clip bonding
- High commutation (4 quadrants) or very high commutation (3 quadrants) capability
- UL1557 recognized components (file ref: 81734)
- RoHS (2002/95/EC) compliant packages

Applications

- On/off function in static relays, heating regulation, induction motor starting circuits
- Phase control operations in light dimmers and motor speed controllers

Description

Available in the Faston terminal RD91 package, the BTA25 is suitable for general purpose AC switching and provides an insulated tab (rated at 2500 V_{RMS}). Representative samples of these components have been evaluated by UL and meet applicable UL requirements for UL 1557 standard (file ref. 81734).



Product status link

BTA25	RD91 insulated package
-----------------------	------------------------

Product summary

$I_{T(RMS)}$	25 A
V_{DRM}/V_{RRM}	600 V to 800 V
I_{GT}	50 mA

1 Characteristics

Table 1. Absolute maximum ratings

Symbol	Parameters		Value	Unit	
$I_{T(RMS)}$	RMS on-state current (180° conduction angle)		$T_c = 100\text{ °C}$	25	A
I_{TSM}	Non repetitive surge peak on-state current (full cycle, T_j initial = 25 °C)	f = 60 Hz	$t_p = 16,7\text{ ms}$	260	A
		f = 50 Hz	$t_p = 20\text{ ms}$	250	
I^2t	I^2t value for fusing	$t_p = 10\text{ ms}$		340	A ² s
di/dt	Critical rate of rise of on-state current $I_G = 2 \times I_{GT}$, $t_r \leq 100\text{ ns}$	f = 120 Hz	$T_j = 125\text{ °C}$	50	A/ μ s
V_{DRM} , V_{RRM}	Repetitive peak off-state voltage		$T_j = 125\text{ °C}$	600 and 800	V
V_{DSM} , V_{RSM}	Non repetitive surge peak off-state voltage	$t_p = 20\text{ ms}$	$T_j = 25\text{ °C}$	V_{DRM} , V_{RRM} + 100	V
I_{GM}	Peak gate current	$t_p = 20\text{ }\mu$ s	$T_j = 125\text{ °C}$	4	A
$P_{G(AV)}$	Average gate power dissipation		$T_j = 125\text{ °C}$	1	W
T_{stg}	Storage junction temperature range			-40 to +150	°C
T_j	Operating junction temperature range			-40 to +125	°C
V_{INS}	Insulation RMS voltage, 1 minute			2500	V

Table 2. Electrical characteristics ($T_j = 25\text{ °C}$, unless otherwise specified) - Snubberless (3 quadrants)

Symbol	Parameters	Quadrant		Value	Unit
$I_{GT}^{(1)}$	$V_D = 12\text{ V}$, $R_L = 33\text{ }\Omega$	I - II - III	Max.	50	mA
V_{GT}		I - II - III	Max.	1.3	
V_{GD}	$V_D = V_{DRM}$, $R_L = 3.3\text{ k}\Omega$, $T_j = 125\text{ °C}$	I - II - III	Min.	0.2	V
$I_H^{(2)}$	$I_T = 500\text{ mA}$		Max.	75	mA
I_L	$I_G = 1.2 I_{GT}$	I - III	Max.	80	
		II	Max.	100	
dV/dt ⁽²⁾	$V_D = 67\%$ V_{DRM} gate open, $T_j = 125\text{ °C}$		Min.	1000	V/ μ s
(di/dt) _c ⁽²⁾	Without snubber, $T_j = 125\text{ °C}$		Min.	22	A/ms

1. Minimum I_{GT} is guaranteed at 5 % of I_{GT} max.
2. For both polarities of A2 referenced to A1

Table 3. Electrical characteristics ($T_j = 25\text{ }^\circ\text{C}$, unless otherwise specified) - standard (4 quadrants)

Symbol	Parameters	Quadrant		Value	Unit
$I_{GT}^{(1)}$	$V_D = 12\text{ V}$, $R_L = 33\ \Omega$	I - II - III IV	Max.	50	mA
V_{GT}				100	
V_{GD}	$V_D = V_{DRM}$, $R_L = 3.3\text{ k}\Omega$, $T_j = 125\text{ }^\circ\text{C}$	All	Max.	1.3	V
$I_H^{(2)}$	$I_T = 500\text{ mA}$	All	Min.	0.2	V
I_L	$I_G = 1.2\ I_{GT}$	I - III - IV	Max.	70	mA
		II	Max.	160	
$dV/dt^{(2)}$	$V_D = 67\% V_{DRM}$ gate open, $T_j = 125\text{ }^\circ\text{C}$		Min.	500	V/ μs
$(dV/dt)_c^{(2)}$	$(dI/dt)_c = 13.3\text{ A/ms}$, $T_j = 125\text{ }^\circ\text{C}$		Min.	10	V/ μs

1. Minimum I_{GT} is guaranteed at 5 % of I_{GT} max.
2. For both polarities of A2 referenced to A1

Table 4. Static electrical characteristics

Symbol	Test conditions	T_j		Value	Unit
$V_{TM}^{(1)}$	$I_{TM} = 35\text{ A}$, $t_p = 380\ \mu\text{s}$	$25\text{ }^\circ\text{C}$	Max.	1.55	V
$V_{TO}^{(1)}$	threshold on-state voltage	$125\text{ }^\circ\text{C}$	Max.	0.85	V
$R_D^{(1)}$	Dynamic resistance	$125\text{ }^\circ\text{C}$	Max.	16	m Ω
I_{DRM}/I_{RRM}	$V_T = V_{DRM}$, $V_T = V_{RRM}$	$25\text{ }^\circ\text{C}$	Max.	5	μA
		$125\text{ }^\circ\text{C}$		3	mA

1. For both polarities of A2 referenced to A1

Table 5. Thermal resistance

Symbol	Parameters		Value	Unit
$R_{th(j-c)}$	Junction to case (AC)	Max.	0.9	$^\circ\text{C/W}$

1.1 Characteristics (curves)

Figure 1. Maximum power dissipation versus on-state RMS current (full cycle)

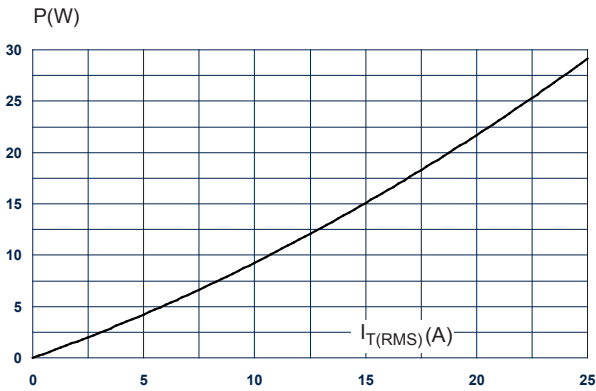

Figure 2. RMS on-state current versus case temperature (full cycle)

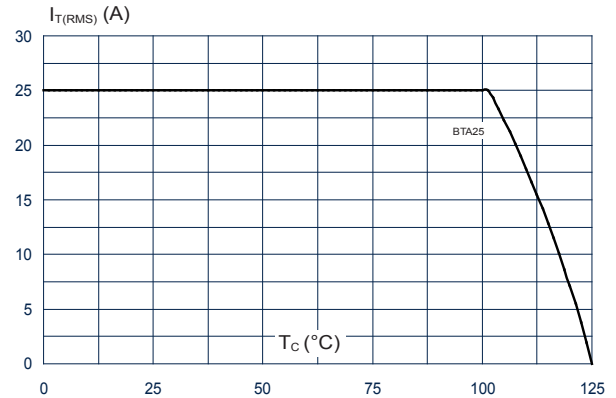

Figure 3. Relative variation of thermal impedance versus pulse duration

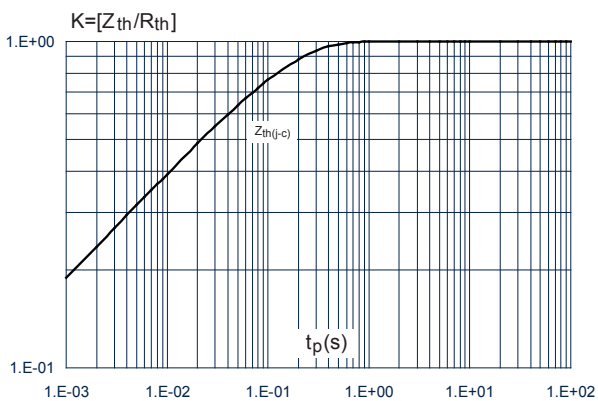

Figure 4. On-state characteristics (maximum values)

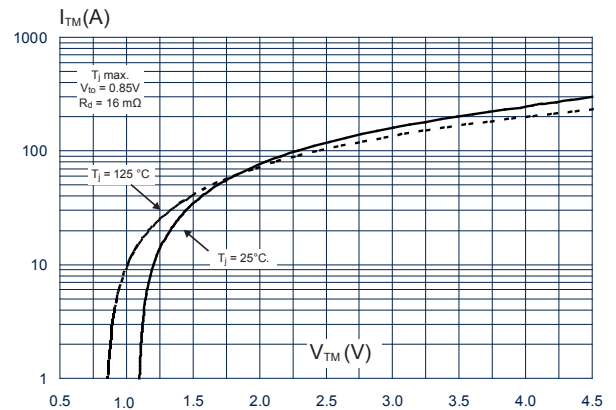

Figure 5. Surge peak on-state current versus number of cycles

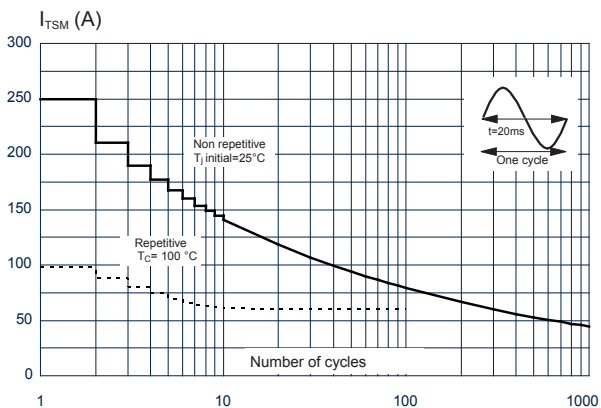

Figure 6. Non-repetitive surge peak on-state current for a sinusoidal pulse with width $t_p < 10\text{ ms}$

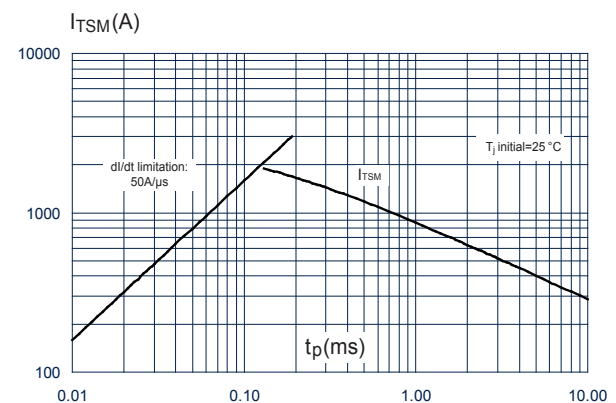
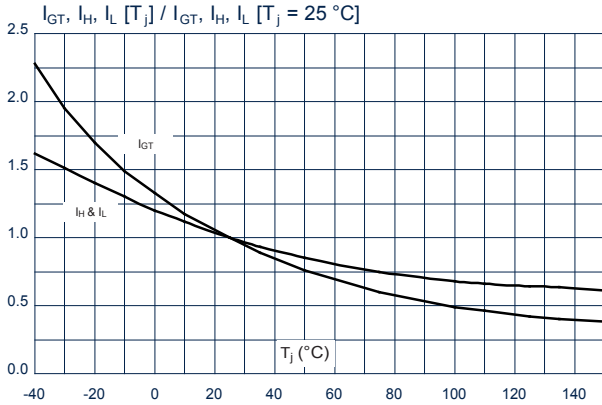
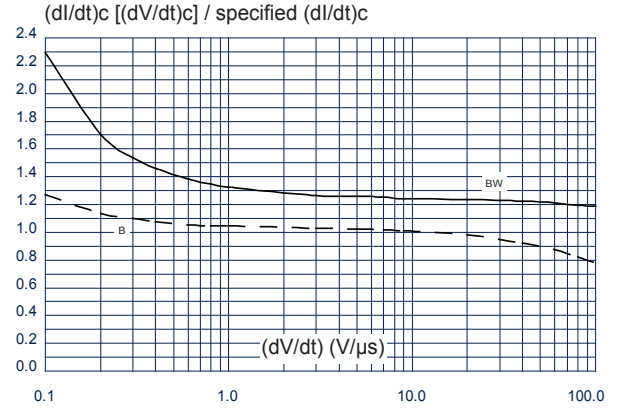
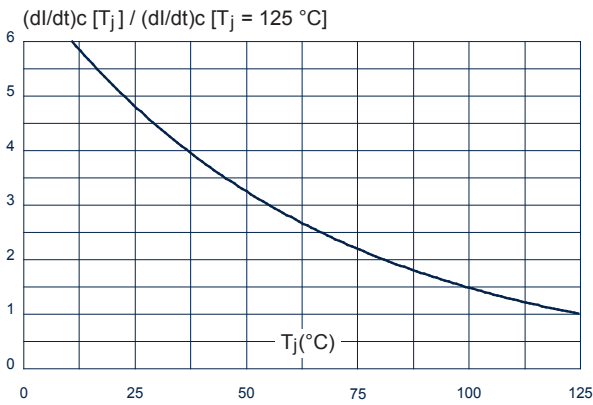
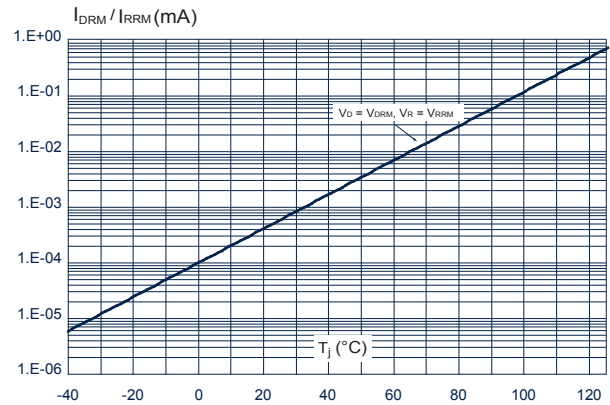

Figure 7. Relative variation of gate trigger current, holding and latching current versus junction temperature (typical values)

Figure 8. Relative variation of critical rate of decrease of main current versus (dV/dt) (typical values)

Figure 9. Relative variation of critical rate of decrease of main current versus junction temperature

Figure 10. Leakage current versus junction temperature for different values of blocking voltage (typical values)

2 Package information

In order to meet environmental requirements, ST offers these devices in different grades of **ECOPACK** packages, depending on their level of environmental compliance. ECOPACK specifications, grade definitions and product status are available at: www.st.com. ECOPACK is an ST trademark.

2.1 RD91 package information

- Epoxy meets UL94, V0
- Cooling method: Conduction
- Recommended torque: 0.9 to 1.2 N·m

Figure 11. RD91 package outline

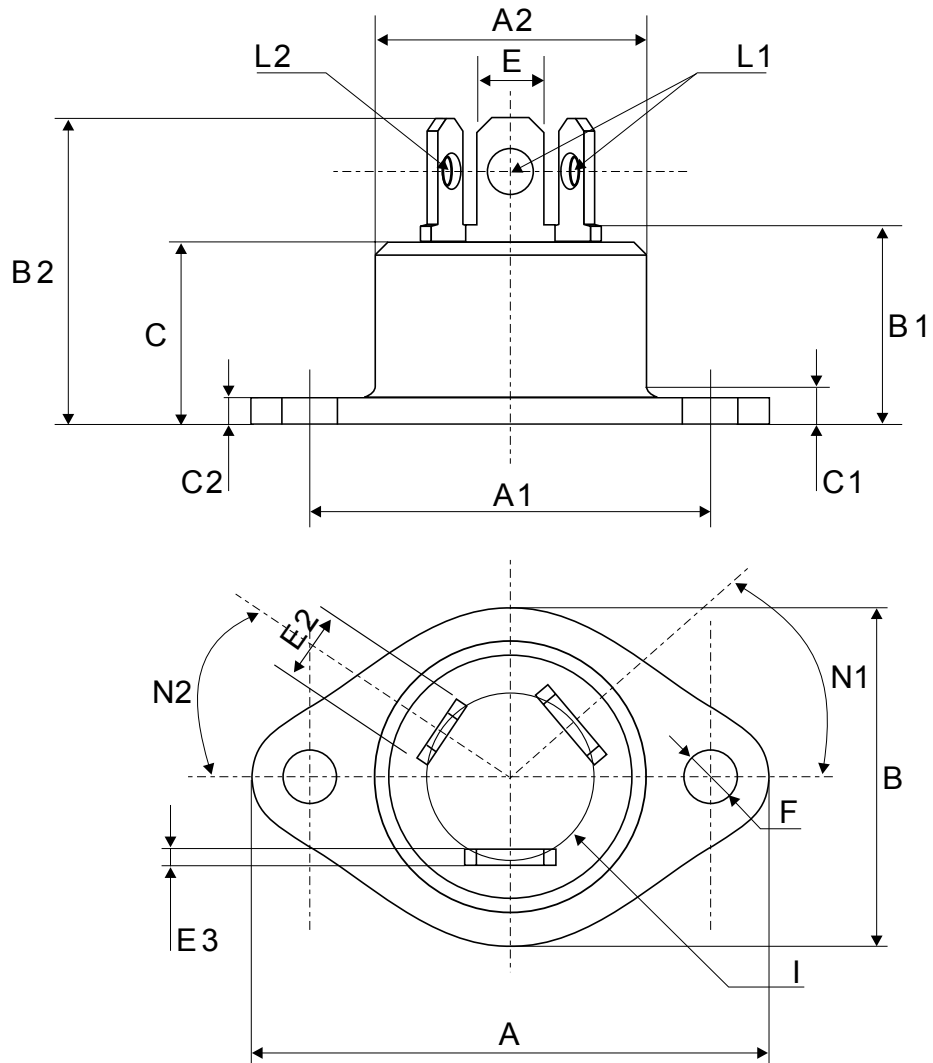

Table 6. RD91 mechanical data

Ref.	Dimensions					
	mm			Inches ⁽¹⁾		
	Min.	Typ.	Max.	Min.	Typ.	Max.
A			40.00			1.575
A1	30.10		30.30	1.185		1.193
A2			22.00			0.867
B			27.00			1.063
B1	13.50		16.50	0.531		0.650
B2			24.00			0.945
C			14.00			0.552
C1			3.50			0.138
C2	1.90		2.10	0.074		0.083
E	6.10		6.50	0.240		0.256
E2	4.80		5.20	0.188		0.205
E3	0.70		0.90	0.027		0.036
F	4.00		4.30	0.157		0.170
I	11.20		11.60	0.440		0.536
L1	3.10		3.50	0.122		0.138
L2	1.70		1.90	0.066		0.075
N1	33°		43°	33°		43°
N2	28°		38°	28°		38°

1. Inches given for reference only

3 Ordering information

Figure 12. Ordering information scheme

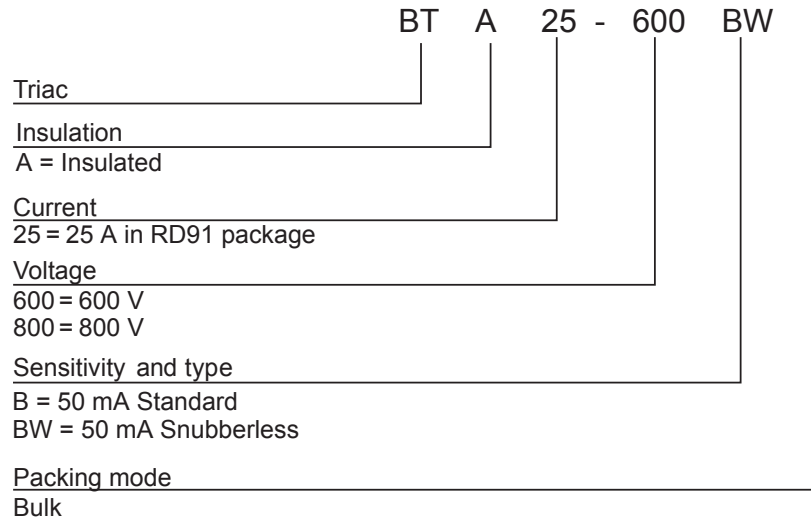

Table 7. Ordering information

Order code	Marking	Package	Weight	Base qty.	Delivery mode
BTA25-600B	BTA25600B	RD91	20 g	25	Bulk
BTA25-600BW	BTA25600BW				
BTA25-800B	BTA25800B				
BTA25-800BW	BTA25800BW				

Revision history

Table 8. Document revision history

Date	Revision	Changes
03-Aug-2021	1	Initial release.

IMPORTANT NOTICE – PLEASE READ CAREFULLY

STMicroelectronics NV and its subsidiaries (“ST”) reserve the right to make changes, corrections, enhancements, modifications, and improvements to ST products and/or to this document at any time without notice. Purchasers should obtain the latest relevant information on ST products before placing orders. ST products are sold pursuant to ST’s terms and conditions of sale in place at the time of order acknowledgement.

Purchasers are solely responsible for the choice, selection, and use of ST products and ST assumes no liability for application assistance or the design of Purchasers’ products.

No license, express or implied, to any intellectual property right is granted by ST herein.

Resale of ST products with provisions different from the information set forth herein shall void any warranty granted by ST for such product.

ST and the ST logo are trademarks of ST. For additional information about ST trademarks, please refer to www.st.com/trademarks. All other product or service names are the property of their respective owners.

Information in this document supersedes and replaces information previously supplied in any prior versions of this document.

© 2021 STMicroelectronics – All rights reserved