

MBRD1035CTL, NRVBD1035VCTL, SBRD81035CTL Series

Switch-mode Schottky Power Rectifier

DPAK Power Surface Mount Package

The MBRD1035CTL employs the Schottky Barrier principle in a large area metal-to-silicon power diode. State of the art geometry features epitaxial construction with oxide passivation and metal overlay contact. Ideally suited for low voltage, high frequency switching power supplies, free wheeling diode and polarity protection diodes.

Features

- Highly Stable Oxide Passivated Junction
- Guardring for Stress Protection
- Matched Dual Die Construction –
May be Paralleled for High Current Output
- High dv/dt Capability
- Short Heat Sink Tap Manufactured – Not Sheared
- Very Low Forward Voltage Drop
- Epoxy Meets UL 94 V-0 @ 0.125 in
- SBRD8 and NRVBD Prefix for Automotive and Other Applications
Requiring Unique Site and Control Change Requirements;
AEC-Q101 Qualified and PPAP Capable
- These Devices are Pb-Free, Halogen Free/BFR Free and are RoHS
Compliant

Mechanical Characteristics:

- Case: Epoxy, Molded
- Weight: 0.4 Gram (Approximately)
- Finish: All External Surfaces Corrosion Resistant and Terminal
Leads are Readily Solderable
- Lead and Mounting Surface Temperature for Soldering Purposes:
260°C Max. for 10 Seconds
- ESD Rating:
 - ◆ Human Body Model = 3B (> 8 kV)
 - ◆ Machine Model = C (> 400 V)



ON Semiconductor®

www.onsemi.com

**SCHOTTKY BARRIER
RECTIFIER
10 AMPERES
35 VOLTS**

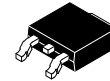

DPAK
CASE 369C

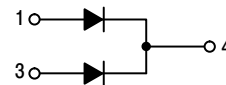

MARKING DIAGRAM

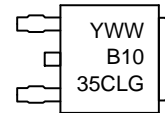

Y = Year
WW = Work Week
B1035CL = Device Code
G = Pb-Free Package

ORDERING INFORMATION

See detailed ordering and shipping information in the package dimensions section on page 3 of this data sheet.

MBRD1035CTL, NRVBD1035VCTL, SBRD81035CTL Series

MAXIMUM RATINGS

Rating	Symbol	Value	Unit
Peak Repetitive Reverse Voltage Working Peak Reverse Voltage DC Blocking Voltage	V_{RRM} V_{RWM} V_R	35	V
Average Rectified Forward Current (At Rated V_R , $T_C = 115^\circ\text{C}$) Per Leg Per Package	I_O	5.0 10	A
Peak Repetitive Forward Current (At Rated V_R , Square Wave, 20 kHz, $T_C = 115^\circ\text{C}$) Per Leg	I_{FRM}	10	A
Non-Repetitive Peak Surge Current (Surge applied at rated load conditions, halfwave, single phase, 60 Hz) Per Package	I_{FSM}	50	A
Storage / Operating Case Temperature	T_{stg}, T_C	-55 to +150	$^\circ\text{C}$
Operating Junction Temperature (Note 1)	T_J	-55 to +150	$^\circ\text{C}$
Voltage Rate of Change (Rated V_R , $T_J = 25^\circ\text{C}$)	dv/dt	10,000	V/ μs

Stresses exceeding those listed in the Maximum Ratings table may damage the device. If any of these limits are exceeded, device functionality should not be assumed, damage may occur and reliability may be affected.

1. The heat generated must be less than the thermal conductivity from Junction-to-Ambient: $dP_D/dT_J < 1/R_{\theta JA}$.

THERMAL CHARACTERISTICS

Rating	Symbol	Value	Unit
Thermal Resistance, Junction-to-Case Per Leg	$R_{\theta JC}$	3.0	$^\circ\text{C/W}$
Thermal Resistance, Junction-to-Ambient (Note 2) Per Leg	$R_{\theta JA}$	137	$^\circ\text{C/W}$

2. Rating applies when using minimum pad size, FR4 PC Board

ELECTRICAL CHARACTERISTICS

Rating	Symbol	Value	Unit
Maximum Instantaneous Forward Voltage (Note 3) (See Figure 2) Per Leg ($I_F = 5$ Amps, $T_J = 25^\circ\text{C}$) ($I_F = 5$ Amps, $T_J = 100^\circ\text{C}$) ($I_F = 10$ Amps, $T_J = 25^\circ\text{C}$) ($I_F = 10$ Amps, $T_J = 100^\circ\text{C}$)	V_F	0.47 0.41 0.56 0.55	V
Maximum Instantaneous Reverse Current (Note 3) (See Figure 4) Per Leg ($V_R = 35$ V, $T_J = 25^\circ\text{C}$) ($V_R = 35$ V, $T_J = 100^\circ\text{C}$) ($V_R = 17.5$ V, $T_J = 25^\circ\text{C}$) ($V_R = 17.5$ V, $T_J = 100^\circ\text{C}$)	I_R	2.0 30 0.20 5.0	mA

Product parametric performance is indicated in the Electrical Characteristics for the listed test conditions, unless otherwise noted. Product performance may not be indicated by the Electrical Characteristics if operated under different conditions.

3. Pulse Test: Pulse Width $\leq 250 \mu\text{s}$, Duty Cycle $\leq 2.0\%$

MBRD1035CTL, NRVBD1035VCTL, SBRD81035CTL Series

ORDERING INFORMATION

Device	Package	Shipping†
MBRD1035CTLG	DPAK (Pb-Free)	75 Units / Rail
SBRD81035CTLG*		75 Units / Rail
SBRD81035CTLG-VF01*		75 Units / Rail
MBRD1035CTLT4G		2,500 Units / Tape & Reel
NRVBD1035VCTLT4G*		2,500 Units / Tape & Reel
SBRD81035CTLT4G*		2,500 Units / Tape & Reel

†For information on tape and reel specifications, including part orientation and tape sizes, please refer to our Tape and Reel Packaging Specifications Brochure, BRD8011/D.

*SBRD8 and NRVBD Prefix for Automotive and Other Applications Requiring Unique Site and Control Change Requirements; AEC-Q101 Qualified and PPAP Capable.

TYPICAL CHARACTERISTICS

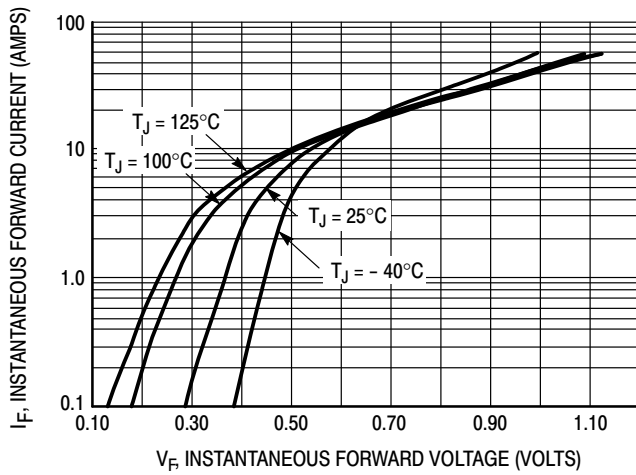

Figure 1. Typical Forward Voltage Per Leg

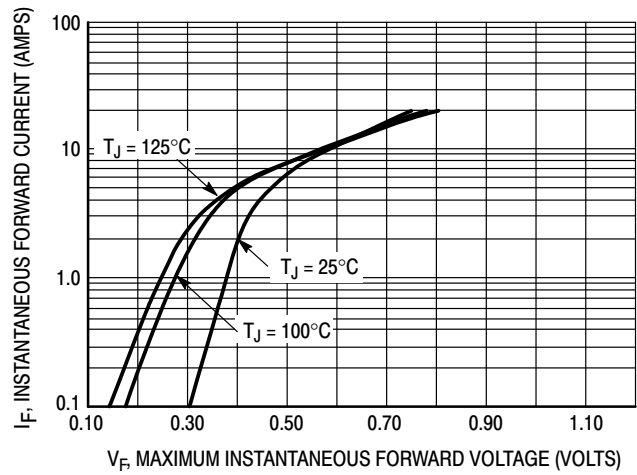

Figure 2. Maximum Forward Voltage Per Leg

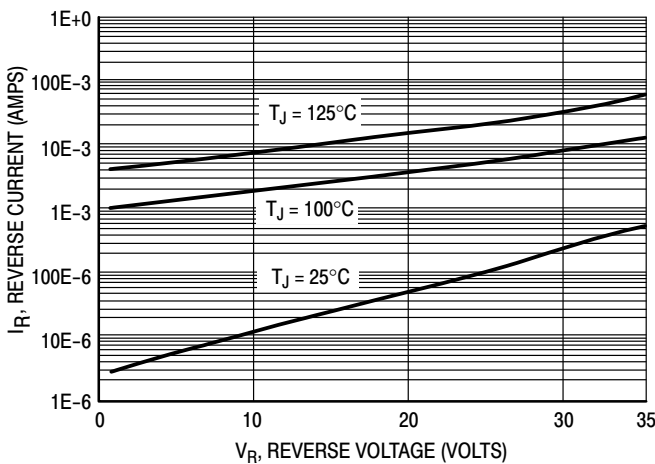

Figure 3. Typical Reverse Current Per Leg

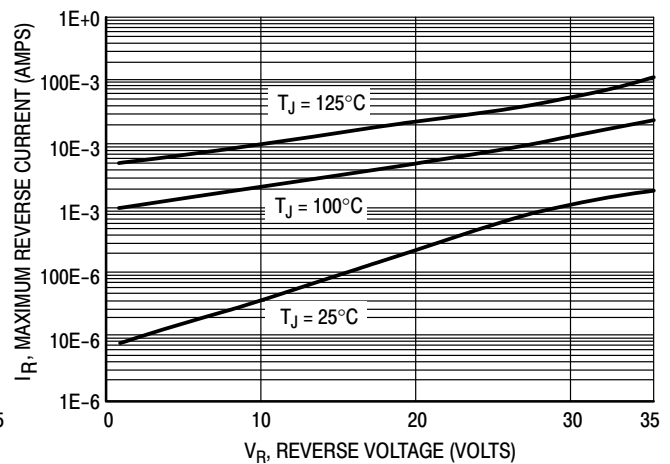

Figure 4. Maximum Reverse Current Per Leg

MBRD1035CTL, NRVBD1035VCTL, SBRD81035CTL Series

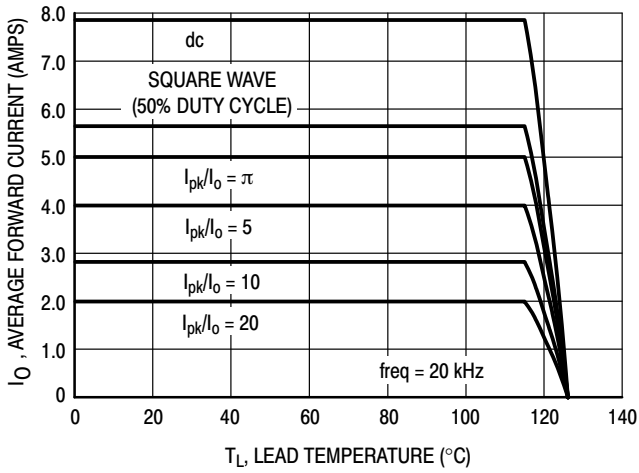

Figure 5. Current Derating Per Leg

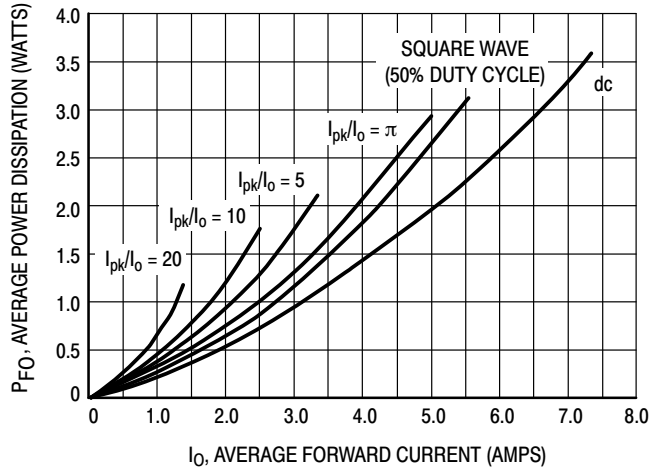

Figure 6. Forward Power Dissipation Per Leg

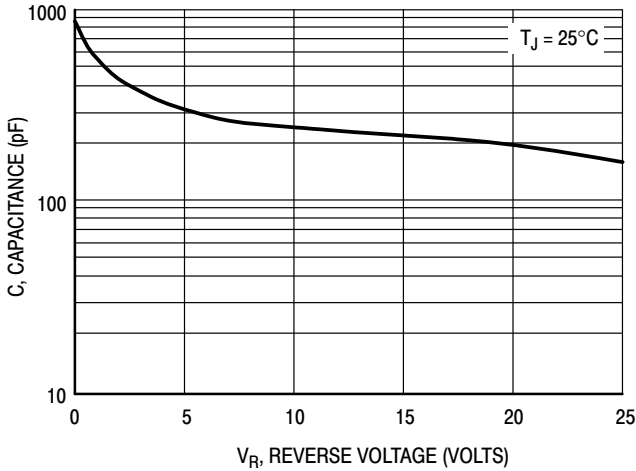

Figure 7. Capacitance Per Leg

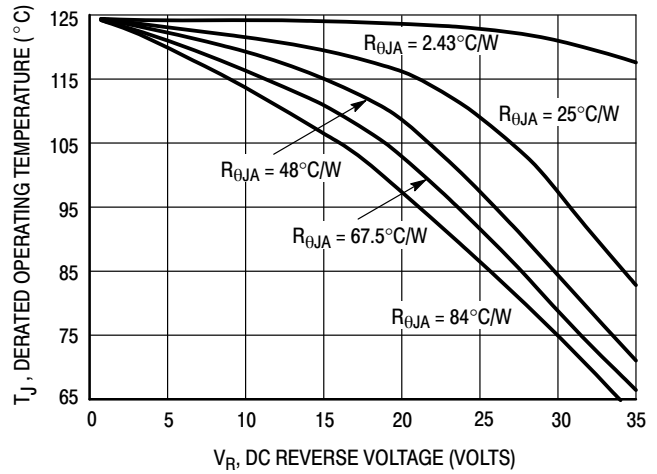

Figure 8. Typical Operating Temperature Derating Per Leg *

* Reverse power dissipation and the possibility of thermal runaway must be considered when operating this device under any reverse voltage conditions. Calculations of T_J therefore must include forward and reverse power effects. The allowable operating T_J may be calculated from the equation:

$$T_J = T_{Jmax} - r(t)(P_f + P_r) \text{ where}$$

$r(t)$ = thermal impedance under given conditions,
 P_f = forward power dissipation, and
 P_r = reverse power dissipation

This graph displays the derated allowable T_J due to reverse bias under DC conditions only and is calculated as $T_J = T_{Jmax} - r(t)P_r$, where $r(t) = R_{thja}$. For other power applications further calculations must be performed.

MBRD1035CTL, NRVBD1035VCTL, SBRD81035CTL Series

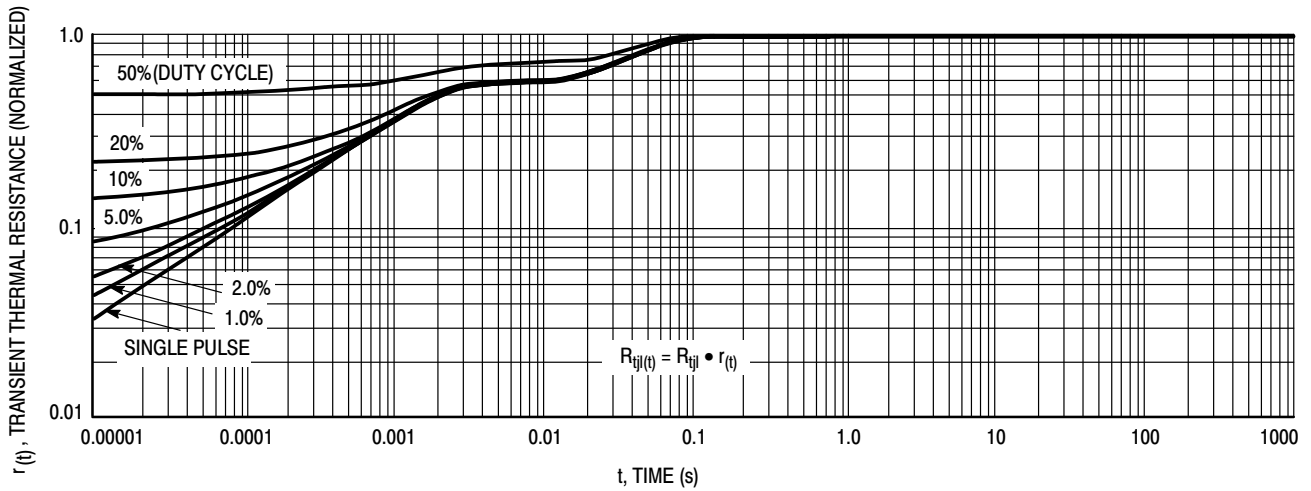

Figure 9. Thermal Response Junction to Case (Per Leg)

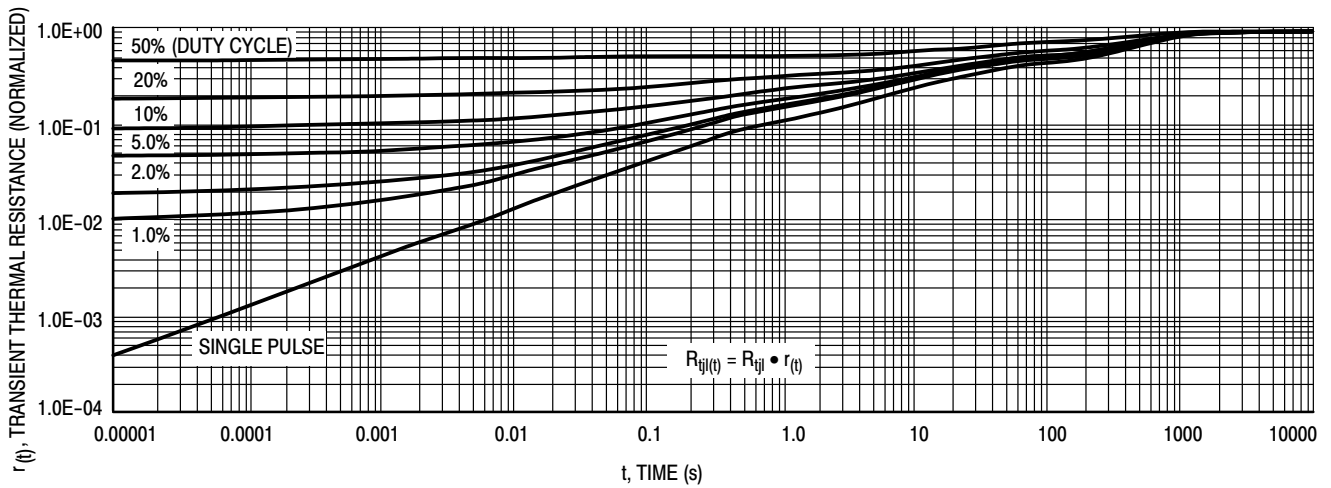
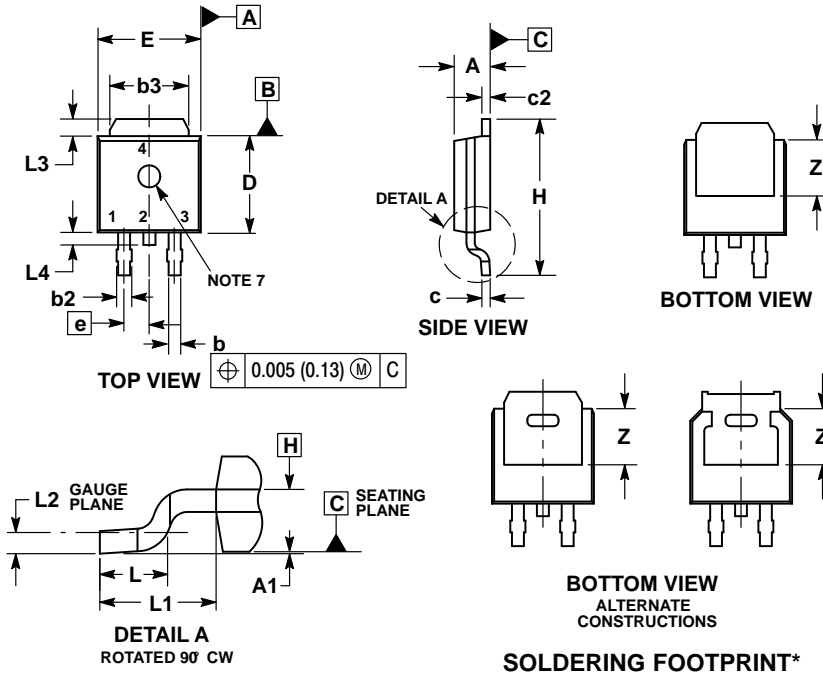

Figure 10. Thermal Response Junction to Ambient (Per Leg)

MBRD1035CTL, NRVBD1035VCTL, SBRD81035CTL Series

PACKAGE DIMENSIONS

DPAK (SINGLE GAUGE) CASE 369C ISSUE F



NOTES:

1. DIMENSIONING AND TOLERANCING PER ASME Y14.5M, 1994.
2. CONTROLLING DIMENSION: INCHES.
3. THERMAL PAD CONTOUR OPTIONAL WITHIN DIMENSIONS b3, L3 and Z.
4. DIMENSIONS D AND E DO NOT INCLUDE MOLD FLASH, PROTRUSIONS, OR BURRS. MOLD FLASH, PROTRUSIONS, OR GATE BURRS SHALL NOT EXCEED 0.006 INCHES PER SIDE.
5. DIMENSIONS D AND E ARE DETERMINED AT THE OUTERMOST EXTREMES OF THE PLASTIC BODY.
6. DATUMS A AND B ARE DETERMINED AT DATUM PLANE H.
7. OPTIONAL MOLD FEATURE.

DIM	INCHES		MILLIMETERS	
	MIN	MAX	MIN	MAX
A	0.086	0.094	2.18	2.38
A1	0.000	0.005	0.00	0.13
b	0.025	0.035	0.63	0.89
b2	0.028	0.045	0.72	1.14
b3	0.180	0.215	4.57	5.46
c	0.018	0.024	0.46	0.61
c2	0.018	0.024	0.46	0.61
D	0.235	0.245	5.97	6.22
E	0.250	0.265	6.35	6.73
e	0.090 BSC		2.29 BSC	
H	0.370	0.410	9.40	10.41
L	0.055	0.070	1.40	1.78
L1	0.114 REF		2.90 REF	
L2	0.020 BSC		0.51 BSC	
L3	0.035	0.050	0.89	1.27
L4	---	0.040	---	1.01
Z	0.155	---	3.93	---

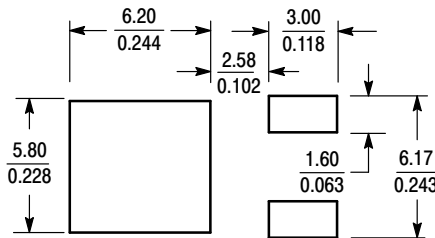

SCALE 3:1 $\left(\frac{\text{mm}}{\text{inches}}\right)$

*For additional information on our Pb-Free strategy and soldering details, please download the ON Semiconductor Soldering and Mounting Techniques Reference Manual, SOLDERRM/D.

ON Semiconductor and are trademarks of Semiconductor Components Industries, LLC dba ON Semiconductor or its subsidiaries in the United States and/or other countries. ON Semiconductor owns the rights to a number of patents, trademarks, copyrights, trade secrets, and other intellectual property. A listing of ON Semiconductor's product/patent coverage may be accessed at www.onsemi.com/site/pdf/Patent-Marking.pdf. ON Semiconductor reserves the right to make changes without further notice to any products herein. ON Semiconductor makes no warranty, representation or guarantee regarding the suitability of its products for any particular purpose, nor does ON Semiconductor assume any liability arising out of the application or use of any product or circuit, and specifically disclaims any and all liability, including without limitation special, consequential or incidental damages. Buyer is responsible for its products and applications using ON Semiconductor products, including compliance with all laws, regulations and safety requirements or standards, regardless of any support or applications information provided by ON Semiconductor. "Typical" parameters which may be provided in ON Semiconductor data sheets and/or specifications can and do vary in different applications and actual performance may vary over time. All operating parameters, including "Typicals" must be validated for each customer application by customer's technical experts. ON Semiconductor does not convey any license under its patent rights nor the rights of others. ON Semiconductor products are not designed, intended, or authorized for use as a critical component in life support systems or any FDA Class 3 medical devices or medical devices with a same or similar classification in a foreign jurisdiction or any devices intended for implantation in the human body. Should Buyer purchase or use ON Semiconductor products for any such unintended or unauthorized application, Buyer shall indemnify and hold ON Semiconductor and its officers, employees, subsidiaries, affiliates, and distributors harmless against all claims, costs, damages, and expenses, and reasonable attorney fees arising out of, directly or indirectly, any claim of personal injury or death associated with such unintended or unauthorized use, even if such claim alleges that ON Semiconductor was negligent regarding the design or manufacture of the part. ON Semiconductor is an Equal Opportunity/Affirmative Action Employer. This literature is subject to all applicable copyright laws and is not for resale in any manner.

PUBLICATION ORDERING INFORMATION

LITERATURE FULFILLMENT:

Literature Distribution Center for ON Semiconductor
19521 E. 32nd Pkwy, Aurora, Colorado 80011 USA
Phone: 303-675-2175 or 800-344-3860 Toll Free USA/Canada
Fax: 303-675-2176 or 800-344-3867 Toll Free USA/Canada
Email: orderlit@onsemi.com

N. American Technical Support: 800-282-9855 Toll Free
USA/Canada
Europe, Middle East and Africa Technical Support:
Phone: 421 33 790 2910
Japan Customer Focus Center
Phone: 81-3-5817-1050

ON Semiconductor Website: www.onsemi.com

Order Literature: <http://www.onsemi.com/orderlit>

For additional information, please contact your local Sales Representative