

Description

Single pole thermal-magnetic circuit breaker with tease-free, trip-free, snap action mechanism and two button operation (M-type TM CBE to EN 60934). Featuring a narrow profile housing, recessed terminals, standard EN rail mounting, and precision CBE performance. Approved to CBE standard EN 60934 (IEC 60934).

Typical applications

Process control systems, instrumentation, rail vehicles.

Ordering information

Type No.	
201	single pole, rail mounted version
201-WA	low-resistance version
Option	
2705	fitted with adapter X 200 409 01
Current ratings	
0.05...16 A	(type 201)
0.05...10 A	(type 201-WA)
201 - ... - ... - 10 A	ordering example

The exact part number required can be built up from the table of choices shown above. Ordering references for optional features should be omitted if not required.

Standard current ratings and typical internal resistance values

Current rating (A)	Internal resistance (Ω)		Current rating (A)	Internal resistance (Ω)	
	201	201-WA		201	201-WA
0.05	447	211	3	0.19	0.054
0.1	131	48	4	0.090	0.035
0.2	40	12.4	5	0.061	0.025
0.3	19.3	5.7	6	0.041	< 0.02
0.4	10.4	3.1	7	0.034	< 0.02
0.5	7.1	2.0	8	< 0.02	< 0.02
0.6	4.3	1.32	10	< 0.02	< 0.02
0.8	2.5	0.76	12	< 0.02	
1	1.67	0.49	14	< 0.02	
1.5	0.61	0.21	15	< 0.02	
2	0.38	0.101	16	< 0.02	
2.5	0.24	0.078			

Approvals

Authority	Voltage ratings	Current ratings
VDE (EN 60 934)	AC 240 V, DC 65 V	0.05...16 A
CSA, UL	AC 250 V, DC 80 V	0.05...16 A

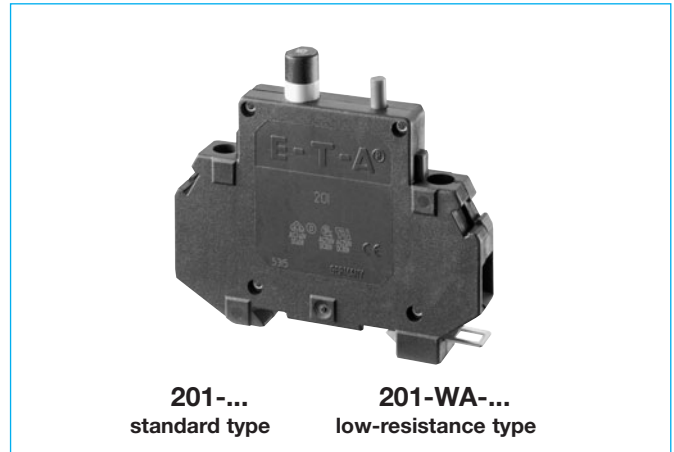

Technical data

For further details please see chapter: **Technical Information**

Voltage rating	AC 240 V (50/60 Hz); DC 65 V (UL: AC 250 V, DC 80 V)		
Current rating range	201: 0.05...16 A 201-WA: 0.05...10 A		
Typical life	5,000 operations at 1 x I_N , inductive 5,000 operations at 2 x I_N , resistive		
Ambient temperature	-30...+60 °C (-22...+140 °F)		
Insulation co-ordination (IEC 60664 and 60664 A)	rated impulse withstand voltage 2.5 kV reinforced insulation	pollution degree 2 in operating area	
Dielectric strength (IEC 60664 and 60664A) operating area	test voltage AC 3,000 V		
Insulation resistance	> 100 M Ω (DC 500 V)		
Interrupting capacity I_{cn}	201	201-WA	
	0.05...0.8 A 1...2 A 2.5...16 A	0.05...0.2 A 0.3...2 A 2.5...10 A	self-limiting 200 A 400 A
Interrupting capacity (UL 1077)	I_N 0.05...16 A 0.05...16 A	U_N AC 250 V DC 80 V	1,000 A 1,000 A
Degree of protection (IEC 60529/DIN 40050)	operating area IP40 terminal area IP20		
Vibration	5 g (57-500 Hz), ± 0.38 mm (10-57 Hz) to IEC 60068-2-6, test Fc 10 frequency cycles/axis		
Shock	25 g (11 ms) to IEC 60068-2-27, test Ea		
Corrosion	96 hours at 5 % salt mist, to IEC 60068-2-11, test Ka		
Humidity	240 hours at 95 % RH to IEC 60068-2-3, test Ca		
Mass	approx. 60 g		

Dimensions

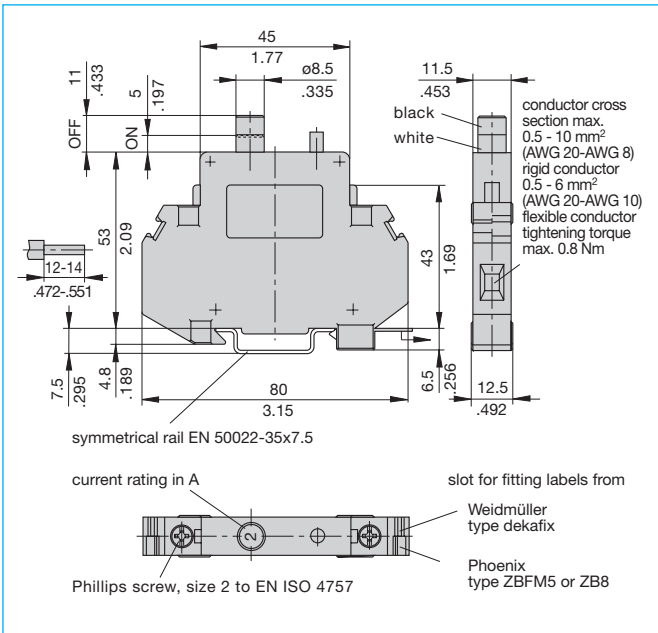

Installation drawing

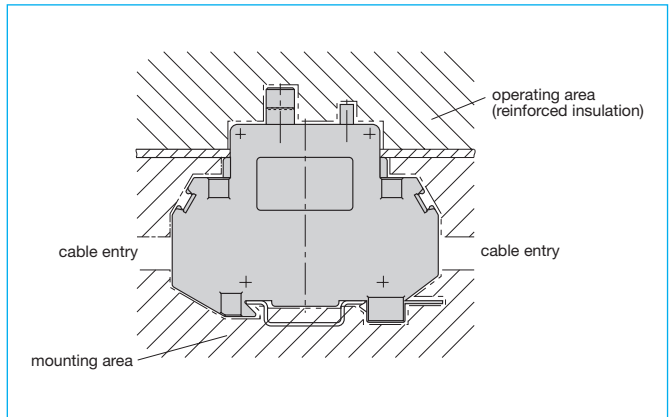

Internal connection diagram

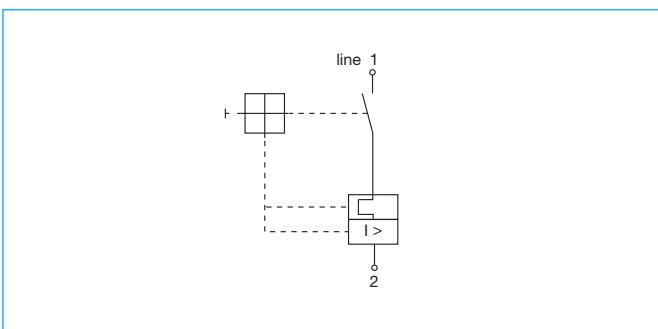

This is a metric design and millimeter dimensions take precedence ($\frac{\text{mm}}{\text{inch}}$)

The time/current characteristic curve depends on the ambient temperature prevailing. In order to eliminate nuisance tripping, please multiply the circuit breaker current ratings by the derating factor shown below. See also section 9 - Technical information.

Ambient temperature °F	-22	-4	+14	+32	+73.4	+104	+122	+140
°C	-30	-20	-10	0	+23	+40	+50	+60
Derating factor	0.76	0.79	0.83	0.88	1	1.08	1.16	1.24

Typical time/current characteristics

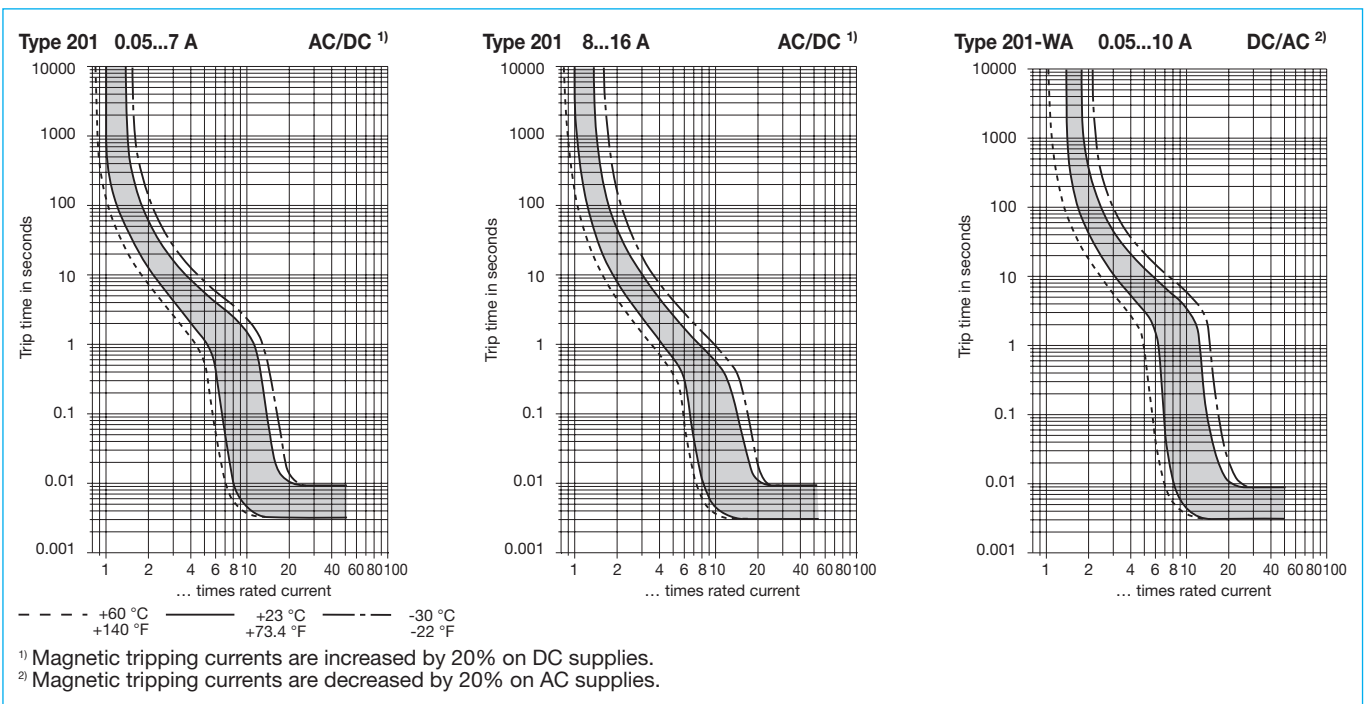

Accessories

**Adapter for EN rail 50035-G32 specified as a separate item
X 200 409 01**

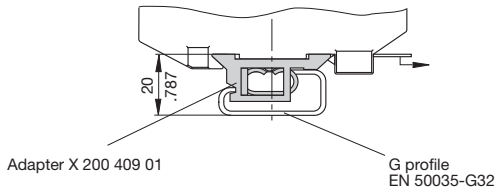

Connector bus links -K10
X 210 589 01/2.5 mm², (AWG 14) (black) up to 20 A max. load
X 210 589 02/1.5 mm², (AWG 16) (brown) up to 13 A max. load

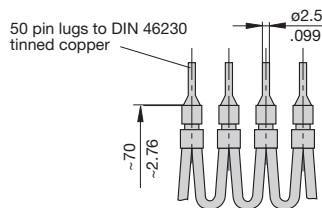

Bus bar
X 221 498 01 (17-way)
 up to 70 A max. load

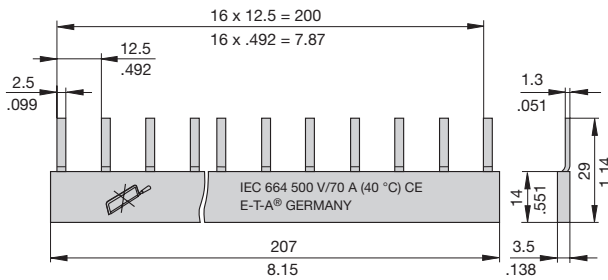

Supply terminal for bus bar
X 221 496 01
 up to 70 A max. load

