

# EMI Common Mode Choke



## BPPM Series



### Overview

An EMI common mode choke (CMC) for power lines is a passive component specifically designed to suppress electromagnetic interference (EMI) in power supply circuits. A full series of common mode choke is designed for excellent noise attenuation with compact sizing for use in wide range of applications. Both standard series and custom designs are available.

### Benefits

1. For DC Power Line Common Mode Filter
2. Miniature SMD type common mode filter for fully automated assembly
3. Wide impedance range (70Ω ~ 3000Ω) for EMI suppression
4. Operating temperature range—40°C~125°C
4. Excellent solderability

### Applications

1. Networking
2. EMI solutions for charger
3. Media player, Dashboard

### Product Information

Series	Size Code (JIS/EIA)	Impedance(Ω)
BPPM	5050/2020	70 ~ 3000
	7060/2824	
	9070/3628	
	1211/4844	
	1513/6052	
	4850/1920	



## BPPM00121164 Series Specification

**1 Scope:** This specification applies to the Pb Free high current type SMD inductors

**2 Part Numbering:**

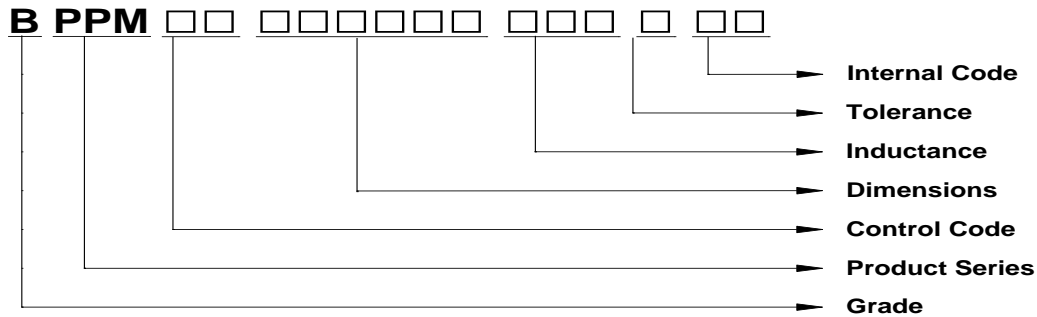

**3 Rating:**

Operating Temperature: - 40°C ~ 125°C(Including self - temperature rise)

Storage Temperature: (on tape & reel): -20°C to +40°C; 75% RH max.

**4 Standard Testing Condition:**

	Unless otherwise specified	In case of doubt
Temperature	Ordinary Temperature(15 to 35°C)	20 to 30°C
Humidity	Ordinary Humidity(25 to 85% RH)	50 to 80 %RH

**5 Configuration and Dimensions and Unit Weight:**

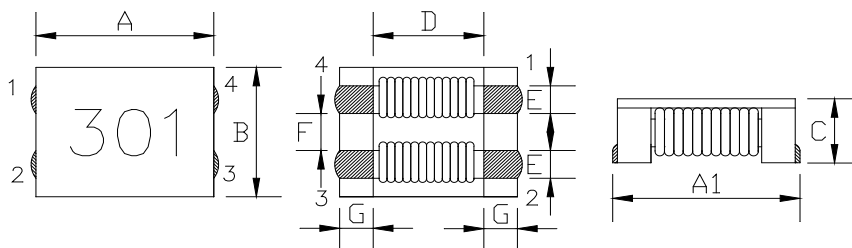

<b>A:</b>	12.0±0.5	mm
<b>A1:</b>	12.5±0.5	mm
<b>B:</b>	10.8±0.5	mm
<b>C:</b>	6.4 Max.	mm
<b>D:</b>	7.0 Typ.	mm
<b>E:</b>	2.7 Typ.	mm
<b>F:</b>	2.5 Typ.	mm
<b>G:</b>	2.5 Typ.	mm

Net Weight (grms)

Marking XXX

Marking color:Black

SIZE CODE	Net Weight (grms)
121164	2.68(Typ.)

## BPPM00121164 Series Specification

### 6 Electrical Characteristics:

PT/NO.	Impedance( $\Omega$ ) at 100MHz		Test Frequency	Resistance RDC( $\Omega$ ) Max.(1 line)	Rated Current (A) Max.	Insulation Resistance (M $\Omega$ ) Min.	Rated Voltage (V)Max.
	Min.	Typ.					
BPPM00121164800X00	80	230	100MHz/0.5V	2.2m Typ.	10	10	125
BPPM00121164701X00	500	700	100MHz/0.5V	6.0m	8	10	125
BPPM00121164801X00	600	800	100MHz/0.5V	8.0m	8	10	125
BPPM00121164102X00	750	1000	100MHz/0.5V	14 m	6	10	125
BPPM00121164222X00	2200	2500	10MHz/0.5V	35 m	1.8	10	125
BPPM00121164272X00	2300	2700	10MHz/0.5V	50 m	1.5	10	125

### CIRCUIT DIAGRAM

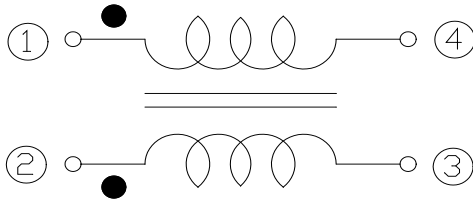

**NOTE:**

1. Rated DC Current : Based on temperature rise ( $\Delta T$  : 40 $^{\circ}$ C Typ.)

## BPPM00121164 Series Specification

### 6 Electrical Characteristics:

#### (6)-1 Impedance

Measured by HP4291B RF Impedance Analyzer.

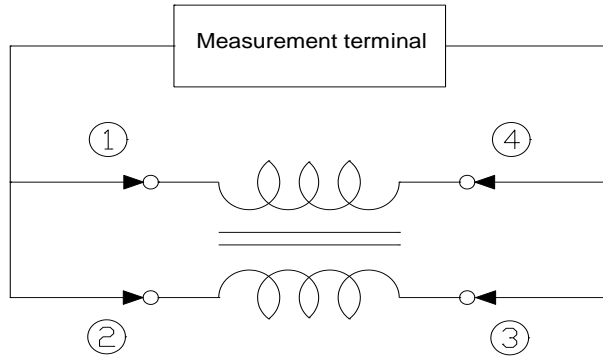

#### (6)-2 DC Resistance

Measured by Chroma 16502 milliohm meter.

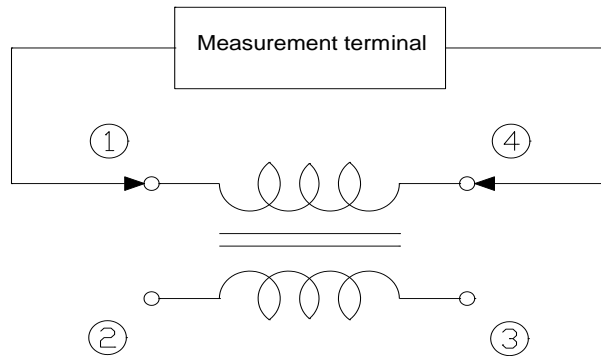

#### (6)-3 Insulation Resistance

Measured by Chroma 19073

Measurement voltage : 50V , Measurement time : 3 sec.

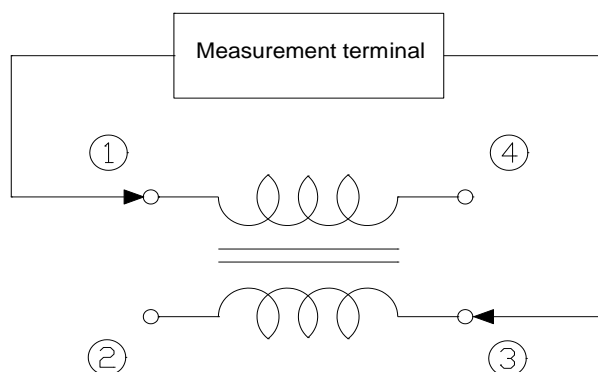

## BPPM00121164 Series Specification

### 6.1 Construction:

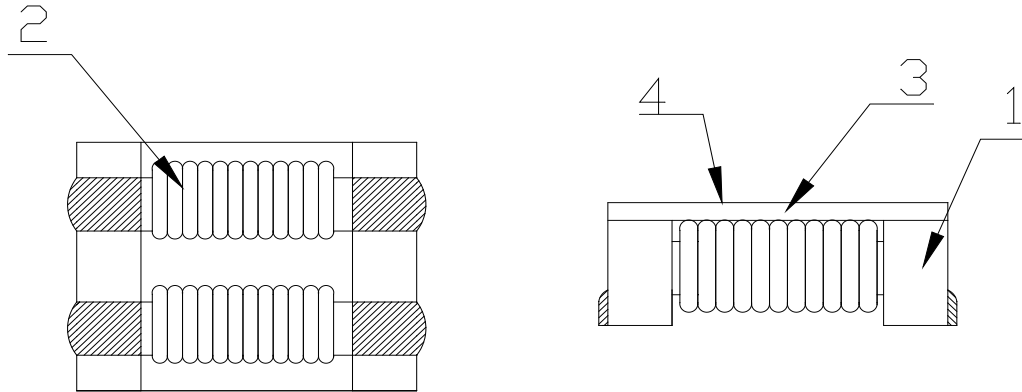

### 6.2 Material List:

NO.	ITEM	DESCRIPTION & TYPE
1	CORE	FERRITE
2	Wire	Magnet Wire
3	Cover	Mayler
4	Marking	INK

**BPPM00121164 Series Specification**

**MECHANICAL**

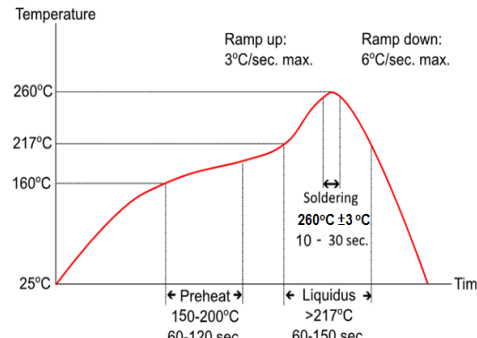
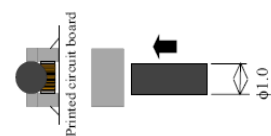
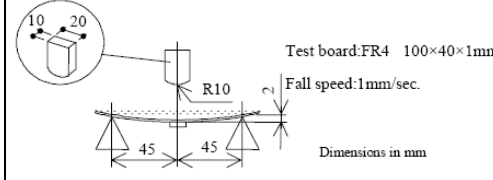
TEST ITEM	SPECIFICATION	TEST DETAILS
Solder ability	The product shall be connected to the test circuit board by the fillet (the height is 0.2mm).	Apply cream solder to the printed circuit board . Refer to clause 8 for Reflow profile.
Resistance to Soldering heat (reflow soldering)	There shall be no damage or problems.	<p>Temperature profile of reflow soldering</p>  <p>Note:  <b>1. Re-Flow Possible times:within 2 times</b>  <b>2. Nitrogen adopted is recommended while in re-flow</b></p>
Terminal strength	The terminal electrode and the ferrite must not be damaged.	<p>Solder a chip to test substrate , and then laterally apply a load 9.8N in the arrow direction.</p> 
Strength on PC board bending	The terminal electrode and the ferrite must not be damaged.	<p>Solder a chip to test substrate and then apply a load.</p> 
High temperature resistance	<p>Impedance:Within±20% of the initial value.</p> <p>Insulation resistance and DC resistance on the specification(refer to clause 2-1) shall be met.</p> <p>The terminal electrode and the ferrite must not be damaged.</p>	<p>After the samples shall be soldered onto the test circuit board,the test shall be done.</p> <p>Measurement : After placing for 24 hours min.</p> <p>Temperature : +125±2°C</p> <p>Applied voltage : Rated voltage</p> <p>Applied current : Rated current</p> <p>Testing time : 500±12 hours</p>

## BPPM00121164 Series Specification

### MECHANICAL

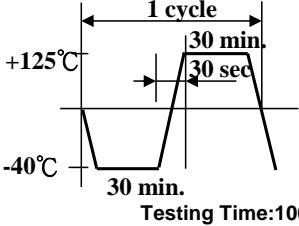
TEST ITEM	SPECIFICATION	TEST DETAILS
Humidity resistance	<p>Impedance: Within <math>\pm 20\%</math> of the initial value.</p> <p>Insulation resistance and DC resistance on the specification (refer to clause 2-1) shall be met.</p> <p>The terminal electrode and the ferrite must not be damaged.</p>	<p>After the samples shall be soldered onto the test circuit board, the test shall be done.</p> <p>Measurement : After placing for 24 hours min.</p> <p>Temperature : <math>+60 \pm 2^\circ\text{C}</math> , Humidity : 90 to 95 %RH</p> <p>Applied voltage : Rated voltage</p> <p>Applied current : Rated current</p> <p>Testing time : <math>500 \pm 12</math> hours</p>
Thermal shock	<p>Impedance: Within <math>\pm 20\%</math> of the initial value.</p> <p>Insulation resistance and DC resistance on the specification (refer to clause 2-1) shall be met.</p> <p>The terminal electrode and the ferrite must not be damaged.</p>	 <p>Testing Time: 100 cycle</p>
Low temperature storage	<p>Impedance: Within <math>\pm 20\%</math> of the initial value.</p> <p>Insulation resistance and DC resistance on the specification (refer to clause 2-1) shall be met.</p> <p>The terminal electrode and the ferrite must not be damaged.</p>	<p>After the samples shall be soldered onto the test circuit board, the test shall be done.</p> <p>Measurement : After placing for 24 hours min.</p> <p>Temperature : <math>-40 \pm 2^\circ\text{C}</math></p> <p>Testing time : <math>500 \pm 12</math> hours</p>
Vibration	<p>Impedance: Within <math>\pm 20\%</math> of the initial value.</p> <p>Insulation resistance and DC resistance on the specification (refer to clause 2-1) shall be met.</p> <p>The terminal electrode and the ferrite must not be damaged.</p>	<p>After the samples shall be soldered onto the test circuit board, the test shall be done.</p> <p>Frequency : 10 to 55 Hz</p> <p>Amplitude : 1.52 mm</p> <p>Dimension and times : X , Y and Z directions for 2 hours each.</p>
Solderability	<p>New solder More than 75%</p>	<p>Flux (rosin, isopropyl alcohol (JIS-K-1522)) shall be coated over the whole of the sample before hard, the sample shall then be preheated for about 2 minutes in a temperature of <math>130 \sim 150^\circ\text{C}</math> and after it has been immersed to a depth 0.5mm below for <math>3 \pm 0.2</math> seconds fully in molten solder M705 with a temperature of <math>245 \pm 2^\circ\text{C}</math>. More than 75% of the electrode sections shall be covered with new solder smoothly when the sample is taken out of the solder bath.</p>

## BPPM00121164 Series Specification

### 7 Packaging:

#### 7.1 Packaging -Cover Tape

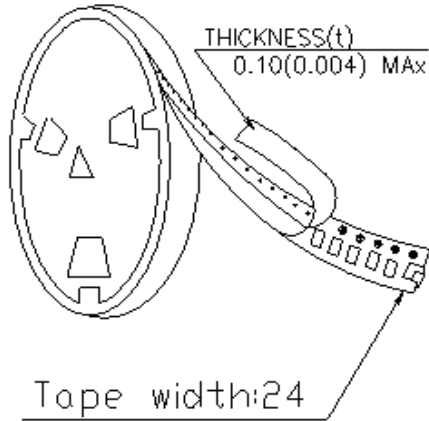

#### 7.2 Packaging Quantity

TYPE	PCS/REEL
BPPM00121164	500

#### 7.3 Reel Dimensions

Unit : mm

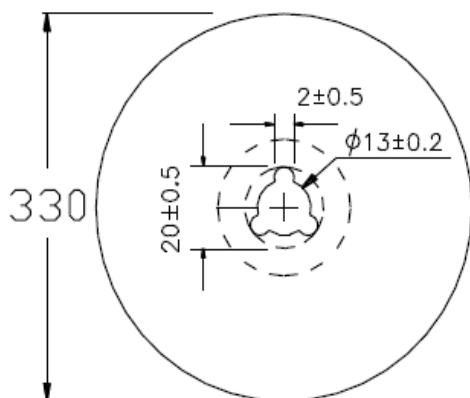

## BPPM00121164 Series Specification

### 7 Packaging:

#### 7.4 Tape Dimensions in mm

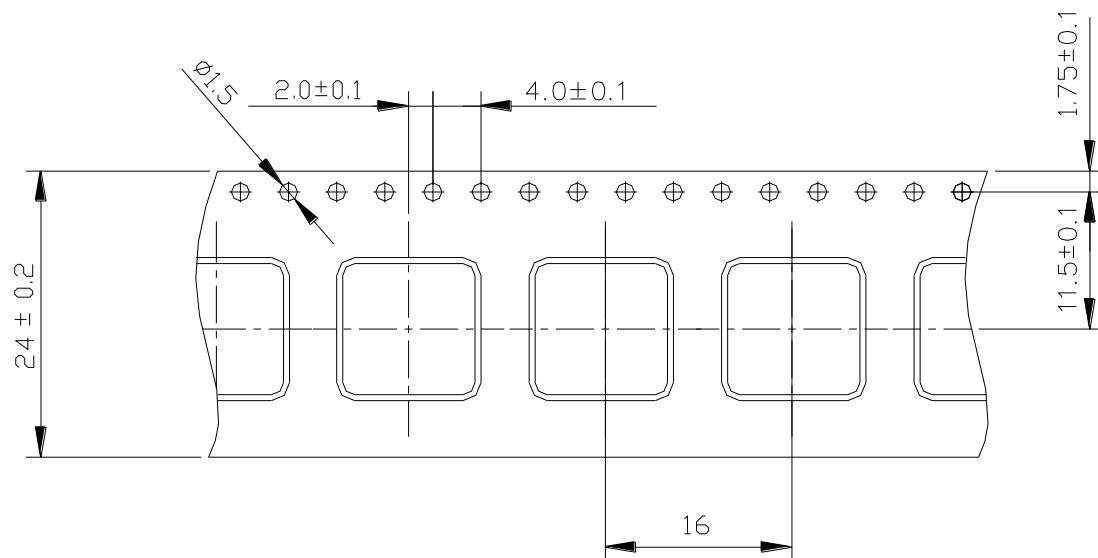

Unreeling  
Direction

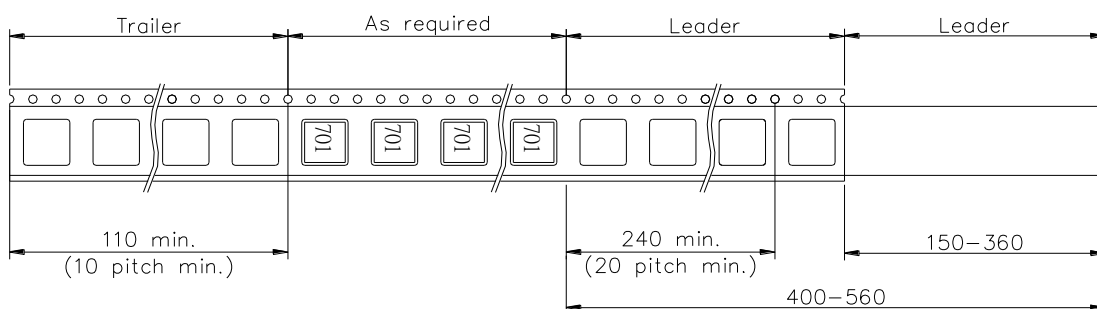
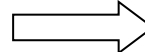

### 8 Recommended Land Pattern:

(STANDARD PATTERN) Unit : mm

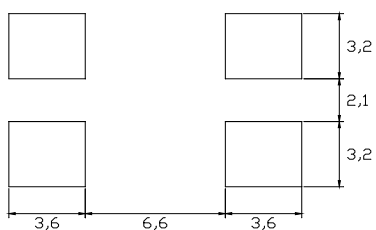

## BPPM00121164 Series Specification

### **9** Note:

1. Please make sure that your product has been evaluated and confirmed against your specifications when our product is mounted to your product.
2. Do not knock or drop.
3. All the items and parameters in this product specification have been prescribed on the premise that our product is used for the purpose, under the condition and in the environment agreed upon between you and us. You are requested not to use our product deviating from such agreement.
4. Please keep the distance between transformer/coil and other components (refer to the standard IEC 950)
5. The moisture sensitivity level (MSL) of products is classified as level 1.

## BPPM00121164 Series Specification

### TYPICAL ELECTRICAL CHARACTERISTICS

#### Frequency vs impedance

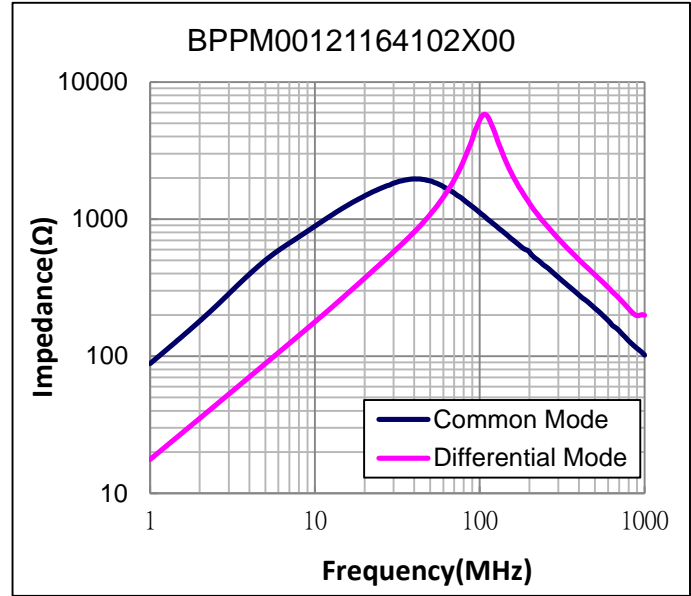
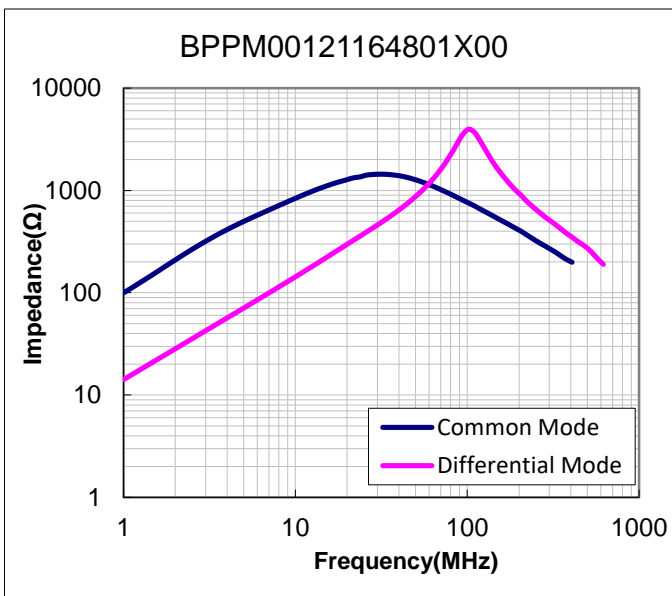
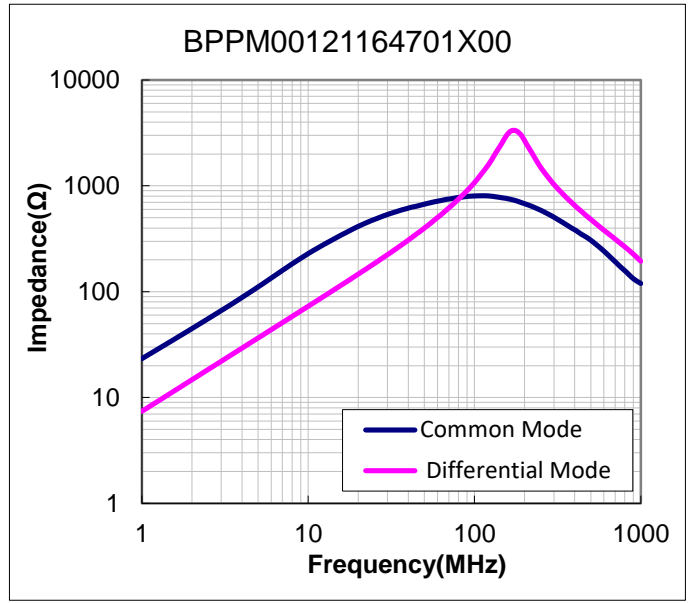
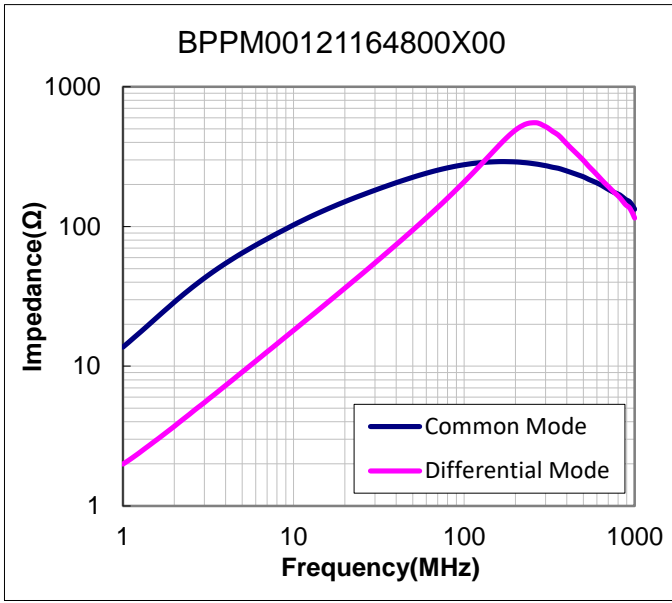

## BPPM00121164 Series Specification

### TYPICAL ELECTRICAL CHARACTERISTICS

#### Frequency vs impedance

