

Data Sheet | Item Number: 831-3104/037-000

1-conductor female connector; Push-in CAGE CLAMP®; 10 mm²; Pin spacing 7.62 mm; 4-pole; 100% protected against mismatching; Lateral locking levers; 10,00 mm²; light gray

<https://www.wago.com/831-3104/037-000>

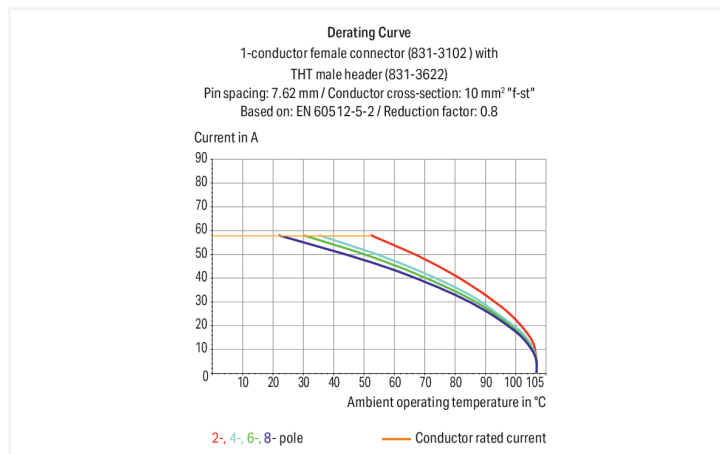
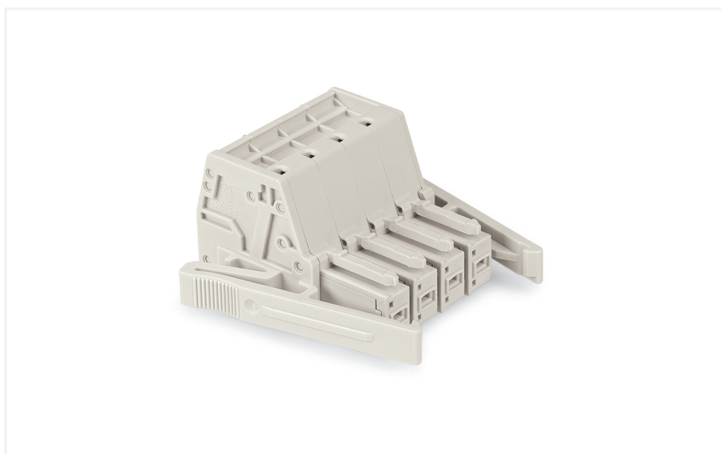

Color: ■ light gray

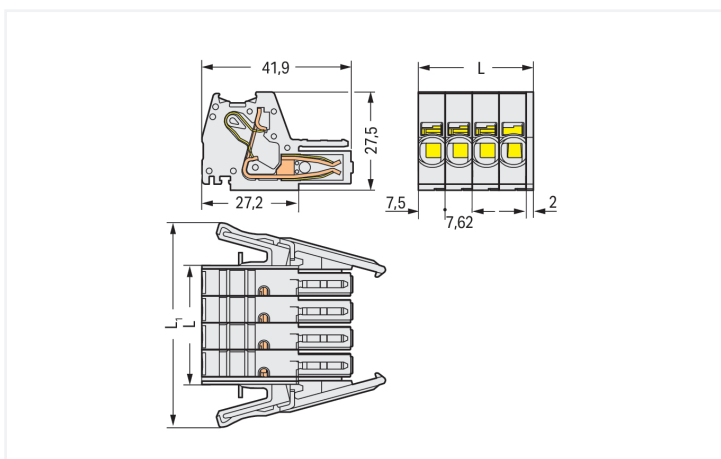

Dimensions in mm

$L = (\text{pole no.} - 1) \times \text{pin spacing} + 10.5 \text{ mm}$
 $L_1 = L + 23.7 \text{ mm}$

Female connector, 831 Series, Push-in CAGE CLAMP®

Our female connector (item number 831-3104/037-000) ensures effortless electrical installations. Conductors can only be connected to this female connector if their strip length is between 13 and 15 mm. This product features one conductor terminal and utilizes Push-in CAGE CLAMP®. Push-in CAGE CLAMP® connection technology is ideal for connecting all conductor types. Solid and fine-stranded conductors with ferrules can be plugged in without needing to use any tools—all thanks to its pluggable design. The item's dimensions are (57.16 x 27.6 x 41.9) mm (width x height x depth). This female connector is suitable for conductor cross sections ranging from 0.5 mm² to 10 mm².

The contact surface is coated with tin.

Notes

Safety Information

The MCS – MULTI CONNECTION SYSTEM includes connectors without breaking capacity in accordance with DIN EN 61984. When used as intended, these connectors must not be connected/disconnected when live or under load. When used as intended, these connectors must not be connected/disconnected when live or under load. The circuit design should ensure header pins, which can be touched, are not live when unmated.

Variants:

Other pole numbers

Other versions (or variants) can be requested from WAGO Sales or configured at <https://configurator.wago.com/>.

Electrical data

Ratings per	IEC/EN 60664-1		
Overvoltage category	III	III	II
Pollution degree	3	2	2
Nominal voltage	800 V	1000 V	1000 V
Rated impulse withstand voltage	8 kV	8 kV	8 kV
Rated current	41 A	41 A	41 A

Approvals per	UL 1059		
Use group	B	C	D
Rated voltage	-	600 V	-
Rated current	-	42 A	-

Approvals per	CSA		
Use group	B	C	D
Rated voltage	-	600 V	-
Rated current	-	41 A	-

Connection Data

Clamping units	4
Total number of potentials	4
Number of connection types	1
Number of levels	1

Connection 1

Connection technology	Push-in CAGE CLAMP®
Actuation type	Operating tool
Actuation direction 1	Operation parallel to conductor entry
Solid conductor	0.5 ... 10 mm ² / 20 ... 8 AWG
Fine-stranded conductor	0.5 ... 10 mm ² / 20 ... 8 AWG
Fine-stranded conductor; with insulated ferrule	0.5 ... 6 mm ²
Fine-stranded conductor; with uninsulated ferrule	0.5 ... 6 mm ²
Strip length	13 ... 15 mm / 0.51 ... 0.59 inches
Pole number	4
Conductor entry direction to mating direction	0°

Physical data

Pin spacing	7.62 mm / 0.3 inches
Width	57.16 mm / 2.25 inches
Height	27.6 mm / 1.087 inches
Depth	41.9 mm / 1.65 inches

Mechanical data

Variable coding	Yes
Anti-rotation protection	Yes

Plug-in connection

Contact type (pluggable connector)	Female connector/socket
Connector (connection type)	for conductor
Mismating protection	Yes
Locking of plug-in connection	Locking lever

Material data

Note (material data)	Information on material specifications can be found here
Color	light gray
Material group	I
Insulation material (main housing)	Polyamide (PA66)
Flammability class per UL94	V0
Clamping spring material	Chrome-nickel spring steel (CrNi)
Material of the additional spring for socket contact	Chrome-nickel spring steel (CrNi)
Contact material	Electrolytic copper (E _{Cu})
Contact Plating	Tin
Fire load	0.45 MJ
Weight	33.8 g

Environmental requirements

Limit temperature range	-60 ... +105 °C
Processing temperature	-35 ... +60 °C

Commercial data

Product Group	3 (Multi Conn. System)
PU (SPU)	12 pcs
Packaging type	Box
Country of origin	PL
GTIN	4066966834154
Customs tariff number	85366990990

Product Classification

UNSPSC	39121409
eCl@ss 10.0	27-14-11-06
eCl@ss 9.0	27-14-11-06
ETIM 9.0	EC001284
ETIM 10.0	EC001284
ECCN	NO US CLASSIFICATION

Environmental Product Compliance

RoHS Compliance Status	Compliant, No Exemption
------------------------	-------------------------

Approvals / Certificates

General approvals



Approval	Standard	Certificate Name
CB DEKRA Certification B.V.	IEC 61984	NL-61360/M1
CSA DEKRA Certification B.V.	C22.2	1466354
DEKRA DEKRA Certification B.V.	EN 61984	71-173515
KEMA/KEUR DEKRA Certification B.V.	EN 61984	71-129589 REV.1
UR Underwriters Laboratories Inc.	UL 1059	UL-US-2426356-0

Downloads

Environmental Product Compliance

Compliance Search
Environmental Product Compliance 831-3104/037-000 ↓

Documentation

Additional Information
Technical Section 03.04.2019 pdf 2027.26 KB ↓

CAD/CAE-Data

CAD data
2D/3D Models 831-3104/037-000 ↓

CAE data
EPLAN Data Portal 831-3104/037-000 ↓
ZUKEN Portal 831-3104/037-000 ↓

1 Compatible Products

1.1 System counterpart

1.1.1 Male connector/plug



Item No.: 831-3204

1-conductor male connector; Push-in CAGE CLAMP®; 10 mm²; Pin spacing 7.62 mm; 4-pole; 100% protected against mismatching; 10,00 mm²; light gray

Item No.: 831-3624

THT male header; 1.0 x 1.2 mm solder pin; angled; 100% protected against mismatching; Pin spacing 7.62 mm; 4-pole; light gray

Item No.: 831-3644

THT male header; 1.0 x 1.2 mm solder pin; angled; 100% protected against mismatching; Pin spacing 7.62 mm; 4-pole; light gray

Item No.: 831-3604

THT male header; 1.0 x 1.2 mm solder pin; straight; 100% protected against mismatching; Pin spacing 7.62 mm; 4-pole; light gray

1.2 Optional Accessories

1.2.1 Marking

1.2.1.1 Marker



Item No.: 2009-145/000-006

Mini-WSB Inline; for Smart Printer; 1700 pieces on roll; stretchable 5 - 5.2 mm; plain; snap-on type; blue

Item No.: 2009-145/000-007

Mini-WSB Inline; for Smart Printer; 1700 pieces on roll; stretchable 5 - 5.2 mm; plain; snap-on type; gray

Item No.: 2009-145/000-023

Mini-WSB Inline; for Smart Printer; 1700 pieces on roll; stretchable 5 - 5.2 mm; plain; snap-on type; green

Item No.: 2009-145/000-012

Mini-WSB Inline; for Smart Printer; 1700 pieces on roll; stretchable 5 - 5.2 mm; plain; snap-on type; orange



Item No.: 2009-145/000-005

Mini-WSB Inline; for Smart Printer; 1700 pieces on roll; stretchable 5 - 5.2 mm; plain; snap-on type; red

Item No.: 2009-145/000-024

Mini-WSB Inline; for Smart Printer; 1700 pieces on roll; stretchable 5 - 5.2 mm; plain; snap-on type; violet

Item No.: 2009-145

Mini-WSB Inline; for Smart Printer; 1700 pieces on roll; stretchable 5 - 5.2 mm; plain; snap-on type; white

Item No.: 2009-145/000-002

Mini-WSB Inline; for Smart Printer; 1700 pieces on roll; stretchable 5 - 5.2 mm; plain; snap-on type; yellow



Item No.: 248-501/000-006

Mini-WSB marking card; as card; not stretchable; plain; snap-on type; blue

Item No.: 248-501/000-007

Mini-WSB marking card; as card; not stretchable; plain; snap-on type; gray

Item No.: 248-501/000-023

Mini-WSB marking card; as card; not stretchable; plain; snap-on type; green

Item No.: 248-501/000-017

Mini-WSB marking card; as card; not stretchable; plain; snap-on type; light green



Item No.: 248-501/000-012

Mini-WSB marking card; as card; not stretchable; plain; snap-on type; orange

Item No.: 248-501/000-005

Mini-WSB marking card; as card; not stretchable; plain; snap-on type; red

Item No.: 248-501

Mini-WSB marking card; as card; not stretchable; plain; snap-on type; white

Item No.: 248-501/000-002

Mini-WSB marking card; as card; not stretchable; plain; snap-on type; yellow



Item No.: 793-5501/000-006

WMB marking card; as card; for terminal block width 5 - 17.5 mm; stretchable 5 - 5.2 mm; plain; snap-on type; blue

Item No.: 793-5501/000-007

WMB marking card; as card; for terminal block width 5 - 17.5 mm; stretchable 5 - 5.2 mm; plain; snap-on type; gray

Item No.: 793-5501/000-023

WMB marking card; as card; for terminal block width 5 - 17.5 mm; stretchable 5 - 5.2 mm; plain; snap-on type; green

Item No.: 793-5501/000-017

WMB marking card; as card; for terminal block width 5 - 17.5 mm; stretchable 5 - 5.2 mm; plain; snap-on type; light green



Item No.: 793-5501/000-012

WMB marking card; as card; for terminal block width 5 - 17.5 mm; stretchable 5 - 5.2 mm; plain; snap-on type; orange

Item No.: 793-5501/000-005

WMB marking card; as card; for terminal block width 5 - 17.5 mm; stretchable 5 - 5.2 mm; plain; snap-on type; red

Item No.: 793-5501/000-024

WMB marking card; as card; for terminal block width 5 - 17.5 mm; stretchable 5 - 5.2 mm; plain; snap-on type; violet

Item No.: 793-5501

WMB marking card; as card; for terminal block width 5 - 17.5 mm; stretchable 5 - 5.2 mm; plain; snap-on type; white



Item No.: 793-5501/000-002

WMB marking card; as card; for terminal block width 5 - 17.5 mm; stretchable 5 - 5.2 mm; plain; snap-on type; yellow

Item No.: 793-501/000-006

WMB marking card; as card; not stretchable; plain; snap-on type; blue

Item No.: 793-501/000-007

WMB marking card; as card; not stretchable; plain; snap-on type; gray

Item No.: 793-501/000-023

WMB marking card; as card; not stretchable; plain; snap-on type; green



Item No.: 793-501/000-017

WMB marking card; as card; not stretchable; plain; snap-on type; light green

Item No.: 793-501/000-012

WMB marking card; as card; not stretchable; plain; snap-on type; orange

Item No.: 793-501/000-005

WMB marking card; as card; not stretchable; plain; snap-on type; red

Item No.: 793-501/000-024

WMB marking card; as card; not stretchable; plain; snap-on type; violet

1.2.1.1 Marker



Item No.: 793-501
WMB marking card; as card; not stretchable; plain; snap-on type; white

Item No.: 793-501/000-002
WMB marking card; as card; not stretchable; plain; snap-on type; yellow

Item No.: 2009-115/000-006
WMB-Inline; for Smart Printer; 1500 pieces on roll; stretchable 5 - 5.2 mm; plain; snap-on type; blue

Item No.: 2009-115/000-007
WMB-Inline; for Smart Printer; 1500 pieces on roll; stretchable 5 - 5.2 mm; plain; snap-on type; gray



Item No.: 2009-115/000-023
WMB-Inline; for Smart Printer; 1500 pieces on roll; stretchable 5 - 5.2 mm; plain; snap-on type; green

Item No.: 2009-115/000-017
WMB-Inline; for Smart Printer; 1500 pieces on roll; stretchable 5 - 5.2 mm; plain; snap-on type; light green

Item No.: 2009-115/000-012
WMB-Inline; for Smart Printer; 1500 pieces on roll; stretchable 5 - 5.2 mm; plain; snap-on type; orange

Item No.: 2009-115/000-024
WMB-Inline; for Smart Printer; 1500 pieces on roll; stretchable 5 - 5.2 mm; plain; snap-on type; violet



Item No.: 2009-115
WMB-Inline; for Smart Printer; 1500 pieces on roll; stretchable 5 - 5.2 mm; plain; snap-on type; white

Item No.: 2009-115/000-002
WMB-Inline; for Smart Printer; 1500 pieces on roll; stretchable 5 - 5.2 mm; plain; snap-on type; yellow

1.2.1.2 Marking strip



Item No.: 2009-110/762-802
Marking strips; for Smart Printer; cut to a defined length; MARKED; Specialty printing; not stretchable; Horizontal marking; snap-on type; white

Item No.: 2009-110/762-803
Marking strips; for Smart Printer; cut to a defined length; MARKED; Specialty printing; not stretchable; Horizontal marking; snap-on type; white

Item No.: 2009-110/762-804
Marking strips; for Smart Printer; cut to a defined length; MARKED; Specialty printing; not stretchable; Horizontal marking; snap-on type; white

Item No.: 2009-110/762-805
Marking strips; for Smart Printer; cut to a defined length; MARKED; Specialty printing; not stretchable; Horizontal marking; snap-on type; white



Item No.: 2009-110/762-806
Marking strips; for Smart Printer; cut to a defined length; MARKED; Specialty printing; not stretchable; Horizontal marking; snap-on type; white

Item No.: 2009-110/762-807
Marking strips; for Smart Printer; cut to a defined length; MARKED; Specialty printing; not stretchable; Horizontal marking; snap-on type; white

Item No.: 2009-110/762-808
Marking strips; for Smart Printer; cut to a defined length; MARKED; Specialty printing; not stretchable; Horizontal marking; snap-on type; white

Item No.: 2009-110
Marking strips; for Smart Printer; on reel; not stretchable; plain; snap-on type; white

1.2.2 Strain relief

1.2.2.1 Strain relief plate



Item No.: 831-505
Strain relief plate; for female and male connectors; 30 mm wide; 1 part; Pin spacing 7.62 mm; light gray

1.2.3 Test and measurement

1.2.3.1 Testing accessories



Item No.: 210-136
Test plug; 2 mm Ø; with 500 mm cable; red

1.2.4 Tool

1.2.4.1 Operating tool



Item No.: 210-721

Operating tool; Blade: 5.5 x 0.8 mm; with a partially insulated shaft; multicoloured

Installation Notes

Conductor termination

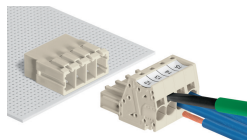

Inserting fine-stranded conductors via (5.5 x 0.8) mm screwdriver.

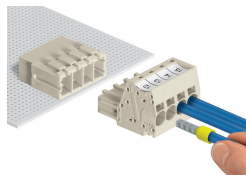

Solid and ferruled conductors are terminated by simply pushing them into unit.

Testing

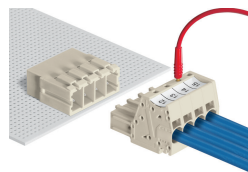

Testing with 2 mm Ø test plug.

Coding

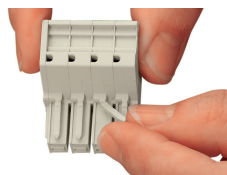

Break or cut off coding pin from female connector.

Marking



Direct marking of female and male connectors



MCS MAXI male and female connectors can also be marked via Mini-WSB or WMB markers.