

# Data Sheet | Item Number: 831-1106

1-conductor female connector; lever; Push-in CAGE CLAMP®; 10 mm<sup>2</sup>; Pin spacing 7.62 mm; 6-pole; 100% protected against mismatching; 10,00 mm<sup>2</sup>; light gray

<https://www.wago.com/831-1106>

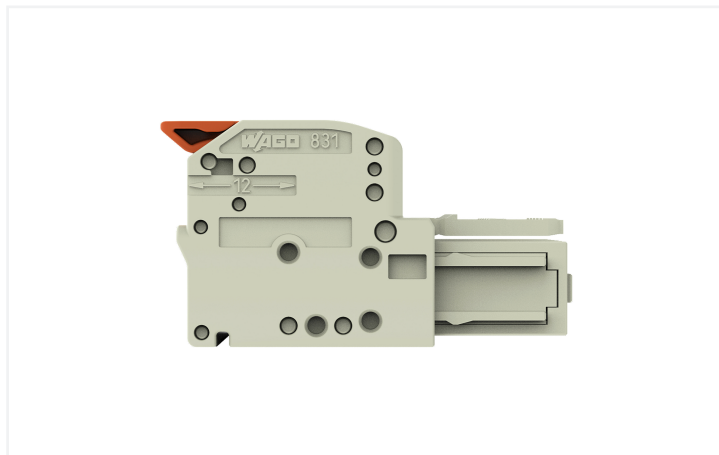
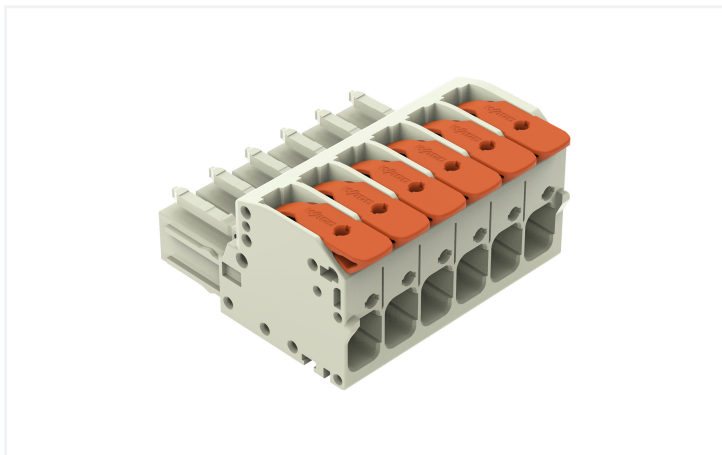

Color: ■ light gray

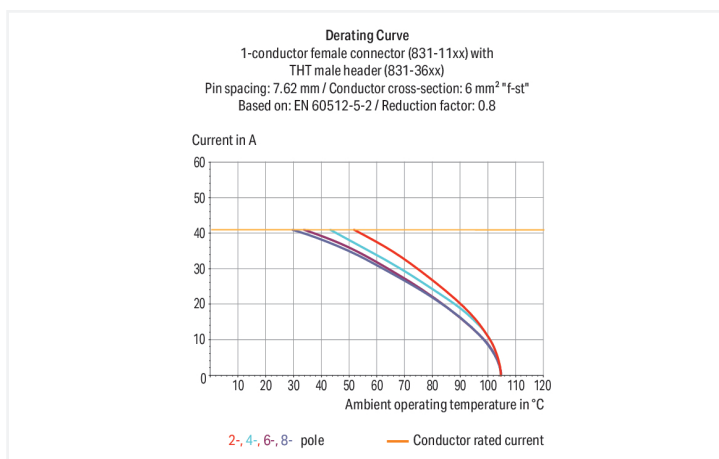
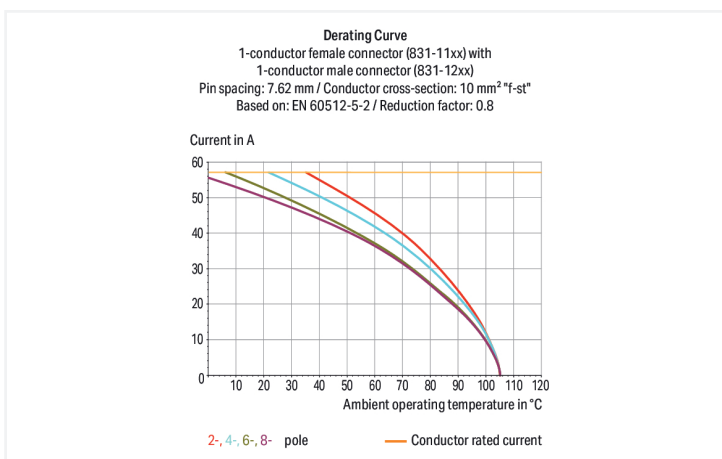

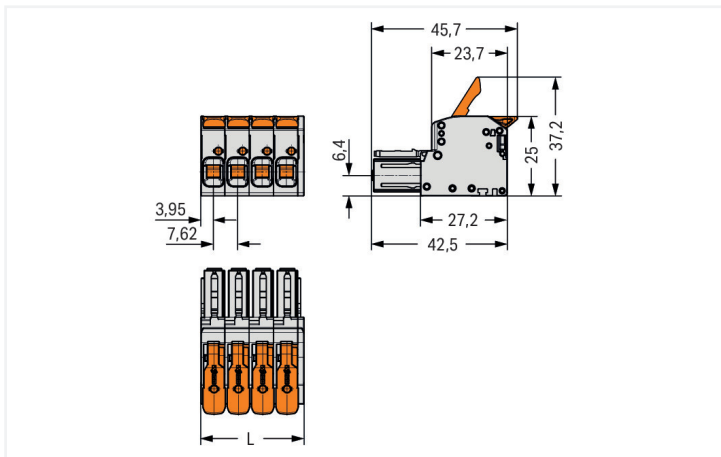

Dimensions in mm

L = (pole no. x pin spacing) + 1.9 mm

Female connector, 831 Series, Push-in CAGE CLAMP®

Seamless electrical installations are guaranteed with this female connector (item number 831-1106). Strip lengths must be between 11 and 13 mm when connecting conductors to this female connector. Featuring one conductor terminal along with Push-in CAGE CLAMP®, this product outperforms the competition. Push-in CAGE CLAMP® technology provides a universal connection solution for any type of conductor. It allows both solid and fine-stranded conductors with ferrules to be inserted directly into the clamping point without the need for tools. Dimensions: (47.6 x 25 x 45.7) mm (width x height x depth). This female connector is suitable for conductor cross sections ranging from 0.5 mm<sup>2</sup> to 10 mm<sup>2</sup>.

Tin is used for coating the contact surfaces.

Notes

Safety Information

The MCS – MULTI CONNECTION SYSTEM includes connectors without breaking capacity in accordance with DIN EN 61984. When used as intended, these connectors must not be connected/disconnected when live or under load. When used as intended, these connectors must not be connected/disconnected when live or under load. The circuit design should ensure header pins, which can be touched, are not live when unmated.

Variants:

Other colors  
Other versions (or variants) can be requested from WAGO Sales or configured at <https://configurator.wago.com/>.

Electrical data

Ratings per	IEC/EN 60664-1		
Oversvoltage category	III	III	II
Pollution degree	3	2	2
Nominal voltage	800 V	1000 V	1000 V
Rated impulse withstand voltage	8 kV	8 kV	8 kV
Rated current	41 A	41 A	41 A

Approvals per	UL 1059		
Use group	B	C	D
Rated voltage	-	600 V	600 V
Rated current	-	37 A	5 A

Approvals per	CSA		
Use group	B	C	D
Rated voltage	-	600 V	600 V
Rated current	-	35 A	5 A

### Connection Data

Clamping units	6
Total number of potentials	6
Number of connection types	1
Number of levels	1

### Connection 1

Connection technology	Push-in CAGE CLAMP®
Actuation type	Lever
Solid conductor	0.5 ... 10 mm <sup>2</sup> / 20 ... 8 AWG
Fine-stranded conductor	0.5 ... 10 mm <sup>2</sup> / 20 ... 8 AWG
Fine-stranded conductor; with insulated ferrule	0.5 ... 6 mm <sup>2</sup>
Fine-stranded conductor; with uninsulated ferrule	0.5 ... 6 mm <sup>2</sup>
Strip length	11 ... 13 mm / 0.43 ... 0.51 inches
Pole number	6
Conductor entry direction to mating direction	0°

### Physical data

Pin spacing	7.62 mm / 0.3 inches
Width	47.6 mm / 1.875 inches
Height	25 mm / 0.984 inches
Depth	45.7 mm / 1.799 inches

### Mechanical data

Variable coding	Yes
Anti-rotation protection	Yes

### Plug-in connection

Contact type (pluggable connector)	Female connector/socket
Connector (connection type)	for conductor
Mismating protection	Yes

### Material data

Note (material data)	<a href="#">Information on material specifications can be found here</a>
Color	light gray
Material group	I
Insulation material (main housing)	Polyamide (PA66)
Flammability class per UL94	V0
Clamping spring material	Chrome-nickel spring steel (CrNi)
Contact material	Electrolytic copper (E <sub>Cu</sub> )
Contact Plating	Tin
Fire load	0.567 MJ
Actuator color	orange
Weight	38.6 g

### Environmental requirements

Limit temperature range	-60 ... +105 °C
Processing temperature	-35 ... +60 °C

### Commercial data

PU (SPU)	24 pcs
Packaging type	Box
Country of origin	PL
GTIN	4066966405613
Customs tariff number	85366990990

### Product Classification

UNSPSC	39121409
ETIM 9.0	EC001284
ETIM 10.0	EC001284
ECCN	NO US CLASSIFICATION

### Environmental Product Compliance

RoHS Compliance Status	Compliant, No Exemption
------------------------	-------------------------

### Approvals / Certificates

#### General approvals



Approval	Standard	Certificate Name
CB DEKRA Certification B.V.	IEC 61984	NL-124478
CSA DEKRA Certification B.V.	C22.2	1466354
DEKRA DEKRA Certification B.V.	EN 61984	71-173515
KEMA/KEUR DEKRA Certification B.V.	EN 61984	71-129589 REV.1
UR Underwriters Laboratories Inc.	UL 1059	UL-US-2426356-0

### Downloads

#### Environmental Product Compliance

##### Compliance Search

Environmental Product  
Compliance 831-1106



## Documentation

### Additional Information

Technical Section	03.04.2019	pdf 2027.26 KB	
-------------------	------------	-------------------	--

## CAD/CAE-Data

### CAD data

2D/3D Models 831-1106



### CAE data

ZUKEN Portal 831-1106



## 1 Compatible Products

### 1.1 System counterpart

#### 1.1.1 Male connector/plug



##### Item No.: 831-1206

1-conductor male connector; lever; Push-in CAGE CLAMP®; 10 mm<sup>2</sup>; Pin spacing 7.62 mm; 6-pole; 100% protected against mismatching; 10,00 mm<sup>2</sup>; light gray



##### Item No.: 831-1206/306-000

1-conductor male connector; lever; Push-in CAGE CLAMP®; 10 mm<sup>2</sup>; Pin spacing 7.62 mm; 6-pole; 100% protected against mismatching; DIN-35 rail/panel mounting; 10,00 mm<sup>2</sup>; light gray



##### Item No.: 831-3626

THT male header; 1.0 x 1.2 mm solder pin; angled; 100% protected against mismatching; Pin spacing 7.62 mm; 6-pole; light gray



##### Item No.: 831-3646

THT male header; 1.0 x 1.2 mm solder pin; angled; 100% protected against mismatching; Pin spacing 7.62 mm; 6-pole; light gray



##### Item No.: 831-3606

THT male header; 1.0 x 1.2 mm solder pin; straight; 100% protected against mismatching; Pin spacing 7.62 mm; 6-pole; light gray

## 1.2 Optional Accessories

### 1.2.1 Ferrule

#### 1.2.1.1 Ferrule



##### Item No.: 216-262

Ferrule; Sleeve for 0.75 mm<sup>2</sup> / 18 AWG; insulated; electro-tin plated; electrolytic copper; gastight crimped; acc. to DIN 46228, Part 4/09.90; gray



##### Item No.: 216-263

Ferrule; Sleeve for 1 mm<sup>2</sup> / AWG 18; insulated; electro-tin plated; electrolytic copper; gastight crimped; acc. to DIN 46228, Part 4/09.90; red



##### Item No.: 216-264

Ferrule; Sleeve for 1.5 mm<sup>2</sup> / AWG 16; insulated; electro-tin plated; electrolytic copper; gastight crimped; acc. to DIN 46228, Part 4/09.90; black



##### Item No.: 216-266

Ferrule; Sleeve for 2.5 mm<sup>2</sup> / AWG 14; insulated; electro-tin plated; electrolytic copper; gastight crimped; acc. to DIN 46228, Part 4/09.90; blue



##### Item No.: 216-267

Ferrule; Sleeve for 4 mm<sup>2</sup> / AWG 12; insulated; electro-tin plated; electrolytic copper; gastight crimped; acc. to DIN 46228, Part 4/09.90; gray



##### Item No.: 216-208

Ferrule; Sleeve for 6 mm<sup>2</sup> / AWG 10; insulated; electro-tin plated; electrolytic copper; gastight crimped; acc. to DIN 46228, Part 4/09.90; yellow



##### Item No.: 216-108

Ferrule; Sleeve for 6 mm<sup>2</sup> / AWG 10; uninsulated; electro-tin plated; silver-colored

## 1.2.2 Mounting adapter

### 1.2.2.1 Mounting accessories



**Item No.: 831-1038**

Mounting adapter; for DIN-35 rail/panel mounting; fixed on DIN-rail 35; Pin spacing 7.62 mm; light gray

**Item No.: 831-1032**

Mounting adapter; for DIN-35 rail/panel mounting; freely movable on DIN-rail 35; Pin spacing 7.62 mm; light gray

## 1.2.3 Strain relief

### 1.2.3.1 Strain relief plate



**Item No.: 831-505**

Strain relief plate; for female and male connectors; 30 mm wide; 1 part; Pin spacing 7.62 mm; light gray

## Installation Notes

### Conductor termination

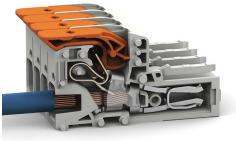

Insert solid conductors via push-in termination.

### Conductor removal

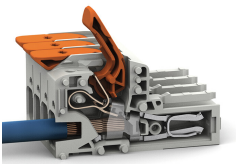

Insert fine-stranded conductors – and remove all conductors – via operating tool.