

Data Sheet | Item Number: 2092-1128

1-conductor female connector; push-button; Push-in CAGE CLAMP®; 2.5 mm²; Pin spacing 5 mm; 8-pole; 2,50 mm²; light gray

<https://www.wago.com/2092-1128>



Color: ■ light gray

Similar to illustration

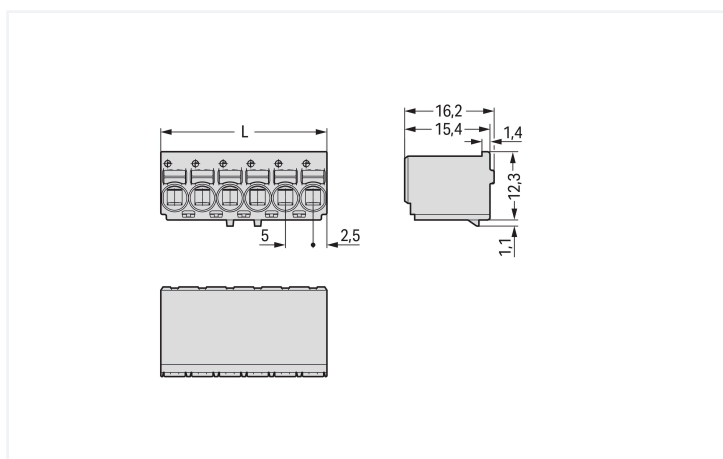
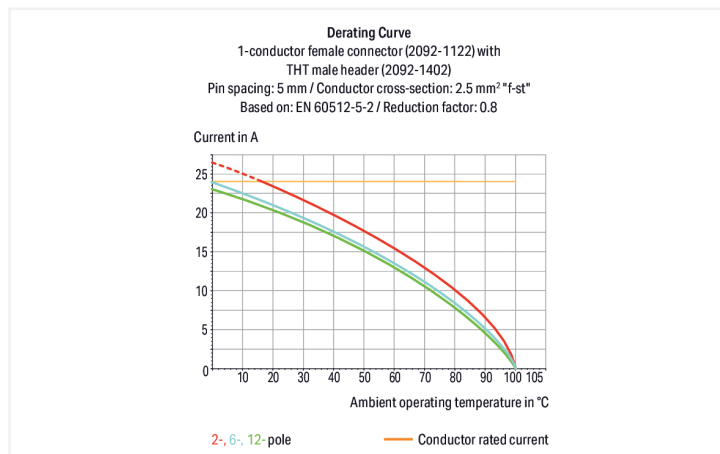

Dimensions in mm

L = pole no. x pin spacing

Female connector, 2092 Series, Push-in CAGE CLAMP®

Enjoy convenient electrical installations with this female connector (item number 2092-1128). Ensure that the strip lengths are between 9 and 10 mm when connecting conductors to this female connector. Featuring one conductor terminal along with Push-in CAGE CLAMP®, this connector delivers reliable performance. Push-in CAGE CLAMP® technology provides a universal connection solution for any type of conductor. It allows both solid and fine-stranded conductors with ferrules to be inserted directly into the clamping point without the need for tools. The item's dimensions are (40 x 16.2 x 13.4) mm (width x height x depth). This female connector is suitable for conductor cross sections ranging from 0.2 mm² to 2.5 mm².

The contact surface is coated with tin.

Notes

Safety Information

The **picoMAX® Pluggable Connection System** includes connectors without breaking capacity in accordance with DIN EN 61984. When used as intended, these connectors must not be connected/disconnected when live or under load. When used as intended, these connectors must not be connected/disconnected when live or under load. The circuit design should ensure header pins, which can be touched, are not live when unmated.

Safety information 2

The use of ferrules is recommended for applications with higher requirements.

To prevent excessive force on the clamping point, effective cable strain relief must be used.

Variants:

Direct marking
Other versions (or variants) can be requested from WAGO Sales or configured at <https://configurator.wago.com/>.

Electrical data

Ratings per	IEC/EN 60664-1			Approvals per	UL 1059		
	III	III	II		Use group	B	C
Overvoltage category	III	III	II	Use group	B	C	D
Pollution degree	3	2	2	Rated voltage	300 V	-	300 V
Nominal voltage	250 V	320 V	630 V	Rated current	15 A	-	10 A
Rated impulse withstand voltage	4 kV	4 kV	4 kV				
Rated current	16 A	16 A	16 A				

Connection Data

Clamping units	8	Connection 1 Connection technology: Push-in CAGE CLAMP® Actuation type: Push-button Actuation direction 1: Operation parallel to conductor entry Solid conductor: 0.2 ... 2.5 mm ² / 24 ... 12 AWG Fine-stranded conductor: 0.2 ... 2.5 mm ² / 24 ... 12 AWG Fine-stranded conductor; with insulated ferrule: 0.25 ... 1.5 mm ² Fine-stranded conductor; with uninsulated ferrule: 0.25 ... 2.5 mm ² Strip length: 9 ... 10 mm / 0.35 ... 0.39 inches Pole number: 8
Total number of potentials	8	
Number of connection types	1	
Number of levels	1	

Physical data

Pin spacing	5 mm / 0.197 inches
Width	40 mm / 1.575 inches
Height	16.2 mm / 0.638 inches
Depth	13.4 mm / 0.528 inches

Mechanical data

Variable coding	Yes
Anti-rotation protection	Yes

Plug-in connection

Contact type (pluggable connector)	Female connector/socket
Connector (connection type)	for conductor
Mismating protection	No
Plugging without loss of pin spacing	Yes

Material data

Note (material data)	Information on material specifications can be found here
Color	light gray
Material group	I
Insulation material (main housing)	Polyphthalamide (PPA GF)
Flammability class per UL94	V0
Clamping spring material	Chrome-nickel spring steel (CrNi)
Contact material	Electrolytic copper (E _{Cu})
Contact Plating	Tin
Fire load	0.083 MJ
Weight	7.4 g

Environmental requirements

Limit temperature range	-60 ... +100 °C
Processing temperature	-35 ... +60 °C

Commercial data

Product Group	26 (picoMAX Connectors)
PU (SPU)	100 pcs
Packaging type	Box
Country of origin	DE
GTIN	4050821163527
Customs tariff number	85366990990

Product Classification

UNSPSC	39121409
eCl@ss 10.0	27-14-11-06
eCl@ss 9.0	27-14-11-06
ETIM 9.0	EC001284
ETIM 10.0	EC001284
ECCN	NO US CLASSIFICATION

Environmental Product Compliance

RoHS Compliance Status	Compliant, No Exemption
------------------------	-------------------------

Approvals / Certificates

General approvals



Approval	Standard	Certificate Name
CB DEKRA Certification B.V.	IEC 61984	NL-89885
CSA CSA Group	C22.2	2362521
CSA DEKRA Certification B.V.	C22.2 No. 158	2362521
cURus Underwriters Laboratories Inc.	UL 1059	E45172
KEMA/KEUR DEKRA Certification B.V.	EN 61984	71-129874
UL Underwriters Laboratories Inc.	UL 1977	E45171

Downloads

Environmental Product Compliance

Compliance Search

Environmental Product
Compliance 2092-1128



Documentation

Additional Information

Technical Section

03.04.2019

pdf
2027.26 KB



CAD/CAE-Data

CAD data

2D/3D Models
2092-1128



CAE data

ZUKEN Portal 2092-1128



1 Compatible Products

1.1 System counterpart

1.1.1 Male connector/plug



Item No.: 2092-1428/200-000

THR male header; 1.4 mm Ø solder pin; angled; Pin spacing 5 mm; 8-pole; light gray



Item No.: 2092-1408/200-000

THR male header; 1.4 mm Ø solder pin; straight; Pin spacing 5 mm; 8-pole; light gray



Item No.: 2092-1728/200-000

THR pin strip; 1.4 mm Ø solder pin; angled; Pin spacing 5 mm; 8-pole; black



Item No.: 2092-1708/200-000

THR pin strip; 1.4 mm Ø solder pin; straight; Pin spacing 5 mm; 8-pole; black



Item No.: 2092-1428/005-000

THT male header; 1.4 mm Ø solder pin; angled; clamping collar; Pin spacing 5 mm; 8-pole; light gray



Item No.: 2092-1428

THT male header; 1.4 mm Ø solder pin; angled; Pin spacing 5 mm; 8-pole; light gray



Item No.: 2092-1408/005-000

THT male header; 1.4 mm Ø solder pin; straight; clamping collar; Pin spacing 5 mm; 8-pole; light gray



Item No.: 2092-1408

THT male header; 1.4 mm Ø solder pin; straight; Pin spacing 5 mm; 8-pole; light gray



Item No.: 2092-1728

THT pin strip; 1.4 mm Ø solder pin; angled; Pin spacing 5 mm; 8-pole; black



Item No.: 2092-1708

THT pin strip; 1.4 mm Ø solder pin; straight; Pin spacing 5 mm; 8-pole; black

1.2 Optional Accessories

1.2.1 Ferrule

1.2.1.1 Ferrule



Item No.: 216-301

Ferrule; Sleeve for 0.25 mm² / AWG 24; insulated; electro-tin plated; yellow



Item No.: 216-131

Ferrule; Sleeve for 0.25 mm² / AWG 24; uninsulated; electro-tin plated; silver-colored



Item No.: 216-302

Ferrule; Sleeve for 0.34 mm² / 22 AWG; insulated; electro-tin plated; light turquoise



Item No.: 216-132

Ferrule; Sleeve for 0.34 mm² / 22 AWG; uninsulated; electro-tin plated



Item No.: 216-101

Ferrule; Sleeve for 0.5 mm² / AWG 22; uninsulated; electro-tin plated; silver-colored



Item No.: 216-202

Ferrule; Sleeve for 0.75 mm² / 18 AWG; insulated; electro-tin plated; gray



Item No.: 216-102

Ferrule; Sleeve for 0.75 mm² / 18 AWG; uninsulated; electro-tin plated; silver-colored



Item No.: 216-122

Ferrule; Sleeve for 0.75 mm² / 18 AWG; uninsulated; electro-tin plated; silver-colored



Item No.: 216-203

Ferrule; Sleeve for 1 mm² / AWG 18; insulated; electro-tin plated; red



Item No.: 216-103

Ferrule; Sleeve for 1 mm² / AWG 18; uninsulated; electro-tin plated



Item No.: 216-143

Ferrule; Sleeve for 1 mm² / AWG 18; uninsulated; electro-tin plated; electrolytic copper; gastight crimped; acc. to DIN 46228, Part 1/08.92



Item No.: 216-204

Ferrule; Sleeve for 1.5 mm² / AWG 16; insulated; electro-tin plated; black



Item No.: 216-144

Ferrule; Sleeve for 1.5 mm² / AWG 16; uninsulated; electro-tin plated; electrolytic copper; gastight crimped; acc. to DIN 46228, Part 1/08.92; silver-colored



Item No.: 216-104

Ferrule; Sleeve for 1.5 mm² / AWG 16; uninsulated; electro-tin plated; silver-colored



Item No.: 216-106

Ferrule; Sleeve for 2.5 mm² / AWG 14; uninsulated; electro-tin plated; silver-colored

1.2.2 Strain relief

1.2.2.1 Gripping plate



Item No.: 2092-1602/002-000

Gripping plate with sliding connector release; for female and male connectors; 2 parts; Pin spacing 5 mm; light gray

Item No.: 2092-1603/002-000

Gripping plate with sliding connector release; for female and male connectors; 2 parts; Pin spacing 5 mm; light gray

Item No.: 2092-1602

Gripping plate; for female and male connectors; 1 part; Pin spacing 5 mm; light gray

Item No.: 2092-1603

Gripping plate; for female and male connectors; 1 part; Pin spacing 5 mm; light gray

1.2.3 Test and measurement

1.2.3.1 Testing accessories



Item No.: 735-500

WAGO Test pin; 1 mm Ø; 30 V AC / 60 V DC; CAT0; 1 A; 6 mm uninsulated; Test lead for soldering up to 0,5mm²

1.2.4 Tool

1.2.4.1 Operating tool



Item No.: 210-719

Operating tool; Blade: 2.5 x 0.4 mm; with a partially insulated shaft

Item No.: 2092-1630

Unlocking tool; orange

Installation Notes

Locking system

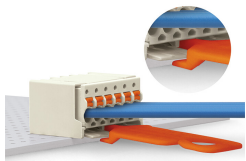

Disconnecting a female connector via unlocking tool. Plug unlocking tool into the male header's locking latch.

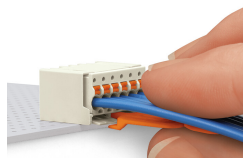

Insert unlocking tool until it hits the back-stop. Wedge opens locking latches.

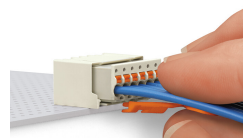

Pull on both unlocking tool and conductors to remove female connector from male header.

Conductor termination

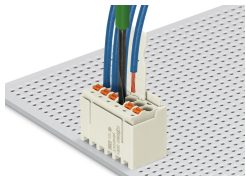

Inserting fine-stranded conductor into mated female connector via push-button.



Inserting a fine-stranded conductor into an unmated female connector via push-button.

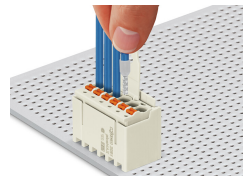

Inserting solid and ferruled conductors via push-in termination.

Marking



Pole marking via factory direct marking.

Coding



Coding a female connector (via coding key carrier and two keys for female connector, see symbol).

Testing



Testing via 1 mm Ø test pin – touch contact.