

Data Sheet | Item Number: 2092-1125

1-conductor female connector; push-button; Push-in CAGE CLAMP®; 2.5 mm²; Pin spacing 5 mm; 5-pole; 2,50 mm²; light gray

<https://www.wago.com/2092-1125>



Color: ■ light gray

Similar to illustration

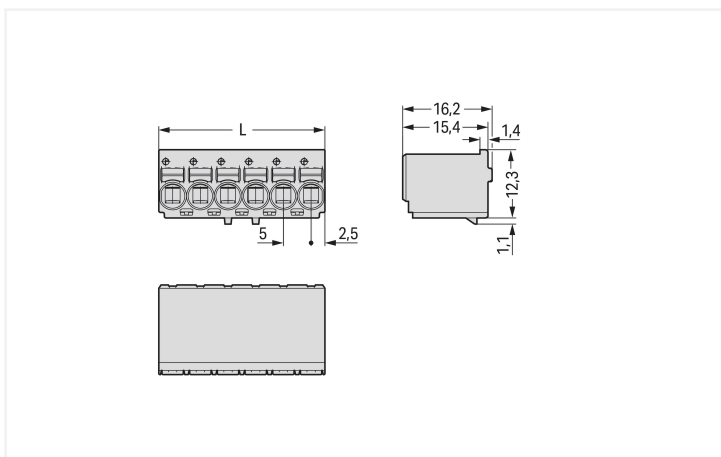
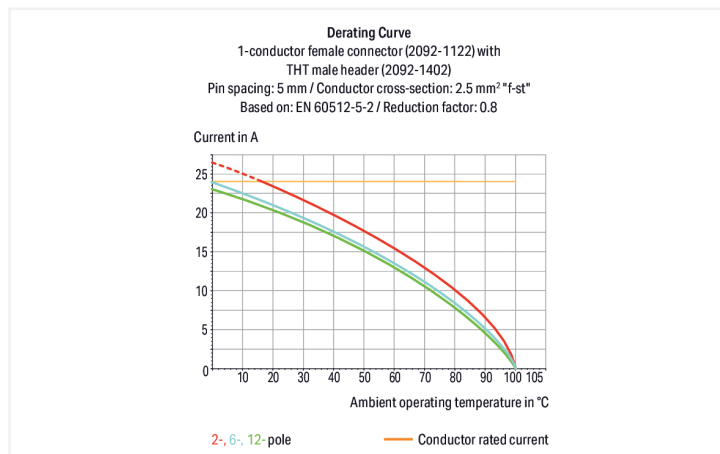

Dimensions in mm

L = pole no. x pin spacing

Female connector, 2092 Series, push-button

Enjoy effortless electrical installations with this female connector (item number 2092-1125). Conductors should only be connected to this female connector if their strip length is between 9 and 10 mm. This product features one conductor terminal and utilizes Push-in CAGE CLAMP®. Our Push-in CAGE CLAMP® is a universal, maintenance-free connection solution for all conductor types, featuring a winning design: both solid and fine-stranded conductors with ferrules can be directly inserted without the need for tools or any preparation, such as crimping the ferrule. Dimensions: (25 x 16.2 x 13.4) mm (width x height x depth). This female connector is suitable for conductor cross sections ranging from 0.2 mm² to 2.5 mm².

Tin is used for coating the contact surfaces.

Notes

Safety Information

The **picoMAX® Pluggable Connection System** includes connectors without breaking capacity in accordance with DIN EN 61984. When used as intended, these connectors must not be connected/disconnected when live or under load. When used as intended, these connectors must not be connected/disconnected when live or under load. The circuit design should ensure header pins, which can be touched, are not live when unmated.

Safety information 2

The use of ferrules is recommended for applications with higher requirements.

To prevent excessive force on the clamping point, effective cable strain relief must be used.

Variants:

Direct marking
Other versions (or variants) can be requested from WAGO Sales or configured at <https://configurator.wago.com/>.

Electrical data

Ratings per	IEC/EN 60664-1			Approvals per	UL 1059		
	III	III	II		Use group	B	C
Overvoltage category	III	III	II	Use group	B	C	D
Pollution degree	3	2	2	Rated voltage	300 V	-	300 V
Nominal voltage	250 V	320 V	630 V	Rated current	15 A	-	10 A
Rated impulse withstand voltage	4 kV	4 kV	4 kV				
Rated current	16 A	16 A	16 A				

Connection Data

Clamping units	5	Connection 1	
Total number of potentials	5	Connection technology	Push-in CAGE CLAMP®
Number of connection types	1	Actuation type	Push-button
Number of levels	1	Actuation direction 1	Operation parallel to conductor entry
		Solid conductor	0.2 ... 2.5 mm ² / 24 ... 12 AWG
		Fine-stranded conductor	0.2 ... 2.5 mm ² / 24 ... 12 AWG
		Fine-stranded conductor; with insulated ferrule	0.25 ... 1.5 mm ²
		Fine-stranded conductor; with uninsulated ferrule	0.25 ... 2.5 mm ²
		Strip length	9 ... 10 mm / 0.35 ... 0.39 inches
		Pole number	5

Physical data

Pin spacing	5 mm / 0.197 inches
Width	25 mm / 0.984 inches
Height	16.2 mm / 0.638 inches
Depth	13.4 mm / 0.528 inches

Mechanical data

Variable coding	Yes
Anti-rotation protection	Yes

Plug-in connection

Contact type (pluggable connector)	Female connector/socket
Connector (connection type)	for conductor
Mismating protection	No
Plugging without loss of pin spacing	Yes

Material data

Note (material data)	Information on material specifications can be found here
Color	light gray
Material group	I
Insulation material (main housing)	Polyphthalamide (PPA GF)
Flammability class per UL94	V0
Clamping spring material	Chrome-nickel spring steel (CrNi)
Contact material	Electrolytic copper (E _{Cu})
Contact Plating	Tin
Fire load	0.051 MJ
Weight	4.5 g

Environmental requirements

Limit temperature range	-60 ... +100 °C
Processing temperature	-35 ... +60 °C

Commercial data

Product Group	26 (picoMAX Connectors)
PU (SPU)	200 pcs
Packaging type	Box
Country of origin	DE
GTIN	4050821163503
Customs tariff number	85366990990

Product Classification

UNSPSC	39121409
eCl@ss 10.0	27-14-11-06
eCl@ss 9.0	27-14-11-06
ETIM 9.0	EC001284
ETIM 10.0	EC001284
ECCN	NO US CLASSIFICATION

Environmental Product Compliance

RoHS Compliance Status	Compliant, No Exemption
------------------------	-------------------------

Approvals / Certificates

General approvals



Approval	Standard	Certificate Name
CB DEKRA Certification B.V.	IEC 61984	NL-89885
CSA CSA Group	C22.2	2362521
CSA DEKRA Certification B.V.	C22.2 No. 158	2362521
cURus Underwriters Laboratories Inc.	UL 1059	E45172
KEMA/KEUR DEKRA Certification B.V.	EN 61984	71-129874
UL Underwriters Laboratories Inc.	UL 1977	E45171

Downloads

Environmental Product Compliance

Compliance Search

Environmental Product
Compliance 2092-1125



Documentation

Additional Information

Technical Section

03.04.2019

pdf
2027.26 KB



CAD/CAE-Data

CAD data

2D/3D Models
2092-1125



CAE data

ZUKEN Portal 2092-1125



1 Compatible Products

1.1 System counterpart

1.1.1 Male connector/plug



Item No.: 2092-1525/020-000

1-conductor male connector; Push-in CAGE CLAMP®; 2.5 mm²; Pin spacing 5 mm; 5-pole; DIN-35 rail/panel mounting; Snap-in mounting feet; Integrated release lever; 2,50 mm²; light gray



Item No.: 2092-1505/002-000

1-conductor male connector; Push-in CAGE CLAMP®; 2.5 mm²; Pin spacing 5 mm; 5-pole; Gripping plate; 2,50 mm²; light gray



Item No.: 2092-1525/002-000

1-conductor male connector; Push-in CAGE CLAMP®; 2.5 mm²; Pin spacing 5 mm; 5-pole; Integrated release lever; 2,50 mm²; light gray



Item No.: 2092-1635/024-000

Panel feedthrough male connector; clamping collar; 2.5 mm²; 5-pole; Pin spacing 5 mm; light gray



Item No.: 2092-1425/205-000

THR male header; 1.4 mm Ø solder pin; angled; clamping collar; Pin spacing 5 mm; 5-pole; light gray



Item No.: 2092-1425/200-000/997-406

THR male header; 1.4 mm Ø solder pin; angled; in tape-and-reel packaging; Pin spacing 5 mm; 5-pole; light gray



Item No.: 2092-1425/200-000

THR male header; 1.4 mm Ø solder pin; angled; Pin spacing 5 mm; 5-pole; light gray



Item No.: 2092-1405/205-000

THR male header; 1.4 mm Ø solder pin; straight; clamping collar; Pin spacing 5 mm; 5-pole; light gray



Item No.: 2092-1405/200-000

THR male header; 1.4 mm Ø solder pin; straight; Pin spacing 5 mm; 5-pole; light gray



Item No.: 2092-1725/200-000

THR pin strip; 1.4 mm Ø solder pin; angled; Pin spacing 5 mm; 5-pole; black



Item No.: 2092-1705/200-000

THR pin strip; 1.4 mm Ø solder pin; straight; Pin spacing 5 mm; 5-pole; black



Item No.: 2092-1425/005-000

THT male header; 1.4 mm Ø solder pin; angled; clamping collar; Pin spacing 5 mm; 5-pole; light gray



Item No.: 2092-1425

THT male header; 1.4 mm Ø solder pin; angled; Pin spacing 5 mm; 5-pole; light gray



Item No.: 2092-1405/005-000

THT male header; 1.4 mm Ø solder pin; straight; clamping collar; Pin spacing 5 mm; 5-pole; light gray



Item No.: 2092-1405

THT male header; 1.4 mm Ø solder pin; straight; Pin spacing 5 mm; 5-pole; light gray



Item No.: 2092-1725

THT pin strip; 1.4 mm Ø solder pin; angled; Pin spacing 5 mm; 5-pole; black



Item No.: 2092-1705

THT pin strip; 1.4 mm Ø solder pin; straight; Pin spacing 5 mm; 5-pole; black

1.2 Optional Accessories

1.2.1 Ferrule

1.2.1.1 Ferrule



Item No.: 216-301

Ferrule; Sleeve for 0.25 mm² / AWG 24; insulated; electro-tin plated; yellow



Item No.: 216-131

Ferrule; Sleeve for 0.25 mm² / AWG 24; uninsulated; electro-tin plated; silver-colored



Item No.: 216-302

Ferrule; Sleeve for 0.34 mm² / 22 AWG; insulated; electro-tin plated; light turquoise



Item No.: 216-132

Ferrule; Sleeve for 0.34 mm² / 22 AWG; uninsulated; electro-tin plated



Item No.: 216-101

Ferrule; Sleeve for 0.5 mm² / AWG 22; uninsulated; electro-tin plated; silver-colored



Item No.: 216-202

Ferrule; Sleeve for 0.75 mm² / 18 AWG; insulated; electro-tin plated; gray



Item No.: 216-102

Ferrule; Sleeve for 0.75 mm² / 18 AWG; uninsulated; electro-tin plated; silver-colored



Item No.: 216-122

Ferrule; Sleeve for 0.75 mm² / 18 AWG; uninsulated; electro-tin plated; silver-colored



Item No.: 216-203

Ferrule; Sleeve for 1 mm² / AWG 18; insulated; electro-tin plated; red



Item No.: 216-103

Ferrule; Sleeve for 1 mm² / AWG 18; uninsulated; electro-tin plated



Item No.: 216-143

Ferrule; Sleeve for 1 mm² / AWG 18; uninsulated; electro-tin plated; electrolytic copper; gastight crimped; acc. to DIN 46228, Part 1/08.92



Item No.: 216-204

Ferrule; Sleeve for 1.5 mm² / AWG 16; insulated; electro-tin plated; black

1.2.1.1 Ferrule



Item No.: 216-144

Ferrule; Sleeve for 1.5 mm² / AWG 16; un-insulated; electro-tin plated; electrolytic copper; gastight crimped; acc. to DIN 46228, Part 1/08.92; silver-colored

Item No.: 216-104

Ferrule; Sleeve for 1.5 mm² / AWG 16; un-insulated; electro-tin plated; silver-colored

Item No.: 216-106

Ferrule; Sleeve for 2.5 mm² / AWG 14; un-insulated; electro-tin plated; silver-colored

1.2.2 Strain relief

1.2.2.1 Gripping plate



Item No.: 2092-1602/002-000

Gripping plate with sliding connector release; for female and male connectors; 2 parts; Pin spacing 5 mm; light gray

1.2.3 Test and measurement

1.2.3.1 Testing accessories



Item No.: 735-500

WAGO Test pin; 1 mm Ø; 30 V AC / 60 V DC; CAT0; 1 A; 6 mm un-insulated; Test lead for soldering up to 0,5mm²

1.2.4 Tool

1.2.4.1 Operating tool



Item No.: 210-719

Operating tool; Blade: 2.5 x 0.4 mm; with a partially insulated shaft

Item No.: 2092-1630

Unlocking tool; orange

Installation Notes

Locking system

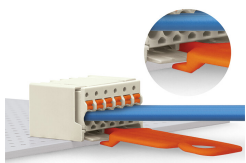

Disconnecting a female connector via un-locking tool. Plug unlocking tool into the male header's locking latch.

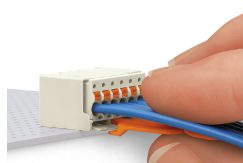

Insert unlocking tool until it hits the back-stop. Wedge opens locking latches.

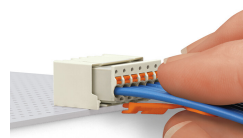

Pull on both unlocking tool and conductors to remove female connector from male header.

Conductor termination

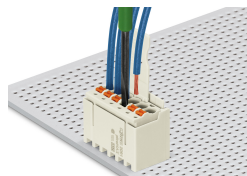

Inserting fine-stranded conductor into mated female connector via push-button.



Inserting a fine-stranded conductor into an unmated female connector via push-button.

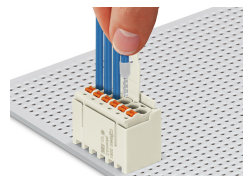

Inserting solid and ferruled conductors via push-in termination.

Marking



Pole marking via factory direct marking.

Coding



Coding a female connector (via coding key carrier and two keys for female connector, see symbol).

Testing



Testing via 1 mm Ø test pin – touch contact.