

Data Sheet | Item Number: 831-1202

1-conductor male connector; lever; Push-in CAGE CLAMP®; 10 mm²; Pin spacing 7.62 mm; 2-pole; 100% protected against mismatching; 10,00 mm²; light gray

<https://www.wago.com/831-1202>

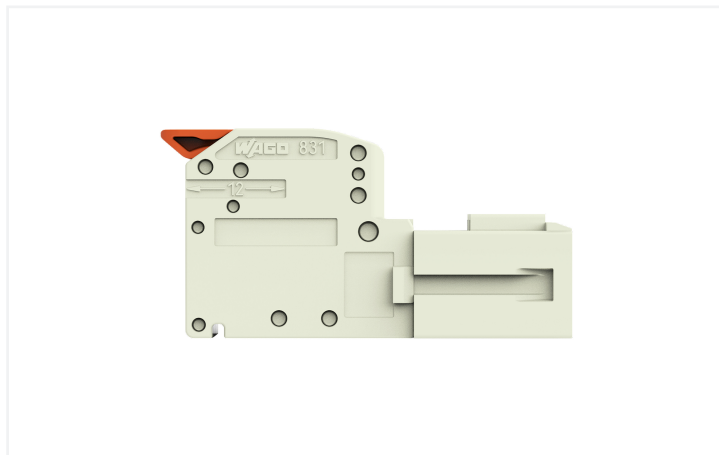
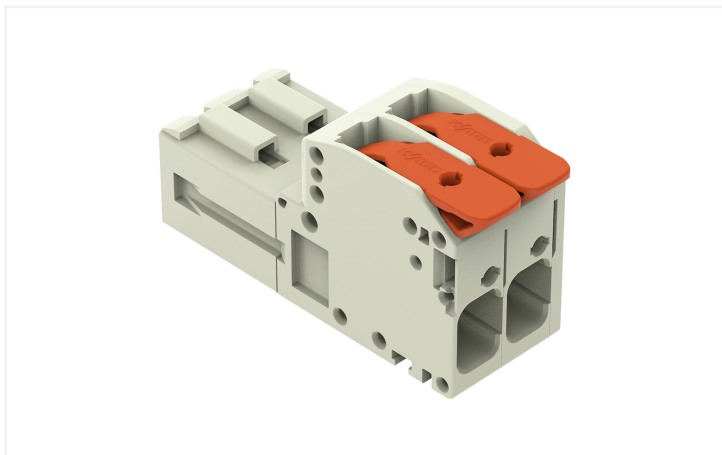

Color: ■ light gray

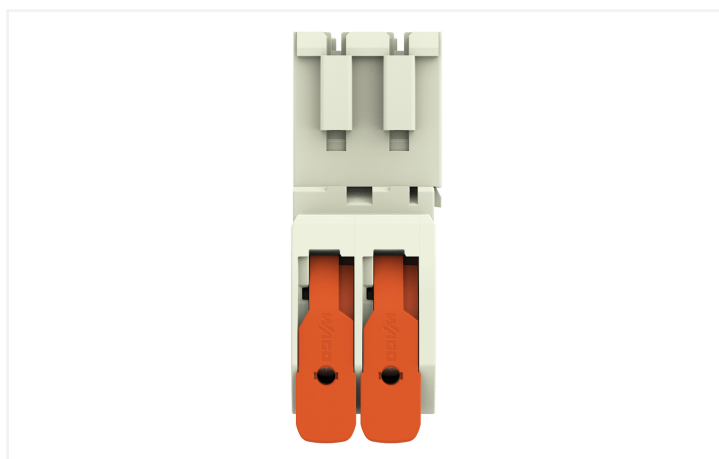
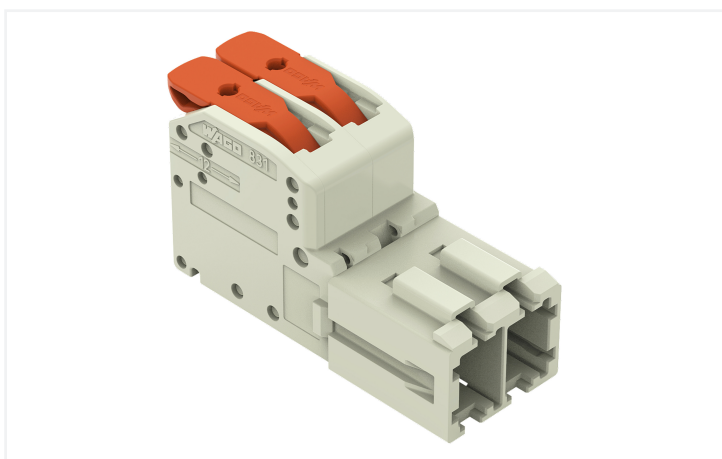

Derating Curve
1-conductor female connector (831-11xx) with
1-conductor male connector (831-12xx)
Pin spacing: 7.62 mm / Conductor cross-section: 10 mm² "f-st"
Based on: EN 60512-5-2 / Reduction factor: 0.8

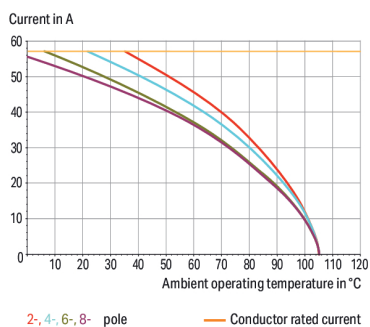

Derating Curve
1-conductor female connector (831-11xx) with
THT male header (831-36xx)
Pin spacing: 7.62 mm / Conductor cross-section: 6 mm² "f-st"
Based on: EN 60512-5-2 / Reduction factor: 0.8

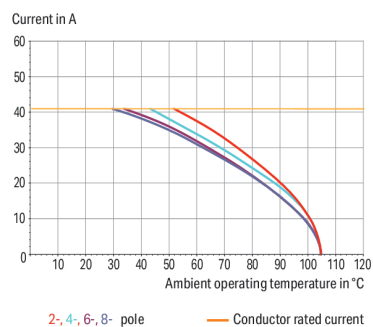

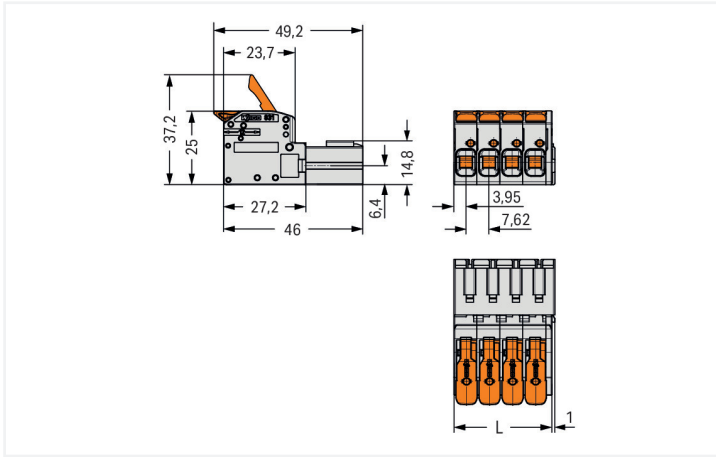

Dimensions in mm

$L = (\text{pole no.} \times \text{pin spacing}) + 1.9 \text{ mm}$

Male connector, 831 Series, 0° conductor exit to connection direction

This male connector (item number 831-1202) provides seamless electrical installations. Ensure that the strip lengths are between 11 and 13 mm when connecting conductors to this male connector. This product features one conductor terminal and utilizes Push-in CAGE CLAMP®. Push-in CAGE CLAMP® connection technology is ideal for connecting all conductor types. Solid and fine-stranded conductors with ferrules can be plugged in without the need for tools—all thanks to its pluggable design. The dimensions are (18.1 x 25 x 49.2) mm (width x height x depth). Depending on the conductor type, this male connector is suitable for conductor cross sections ranging from 0.5 mm² to 10 mm².

The contact surface is coated with tin.

Notes

Safety Information

The MCS – MULTI CONNECTION SYSTEM includes connectors without breaking capacity in accordance with DIN EN 61984. When used as intended, these connectors must not be connected/disconnected when live or under load. When used as intended, these connectors must not be connected/disconnected when live or under load. The circuit design should ensure header pins, which can be touched, are not live when unmated.

Variants:

Other colors
Other versions (or variants) can be requested from WAGO Sales or configured at <https://configurator.wago.com/>.

Electrical data

Ratings per	IEC/EN 60664-1		
Overtoltage category	III	III	II
Pollution degree	3	2	2
Nominal voltage	800 V	1000 V	1000 V
Rated impulse withstand voltage	8 kV	8 kV	8 kV
Rated current	41 A	41 A	41 A

Approvals per	UL 1059		
Use group	B	C	D
Rated voltage	-	600 V	600 V
Rated current	-	37 A	5 A

Approvals per	CSA		
Use group	B	C	D
Rated voltage	-	600 V	600 V
Rated current	-	35 A	5 A

Connection Data

Clamping units	2
Total number of potentials	2
Number of connection types	1
Number of levels	1

Connection 1

Connection technology	Push-in CAGE CLAMP®
Actuation type	Lever
Solid conductor	0.5 ... 10 mm ² / 20 ... 8 AWG
Fine-stranded conductor	0.5 ... 10 mm ² / 20 ... 8 AWG
Fine-stranded conductor; with insulated ferrule	0.5 ... 6 mm ²
Fine-stranded conductor; with uninsulated ferrule	0.5 ... 6 mm ²
Strip length	11 ... 13 mm / 0.43 ... 0.51 inches
Pole number	2
Conductor entry direction to mating direction	0°

Physical data

Pin spacing	7.62 mm / 0.3 inches
Width	18.1 mm / 0.7 inches
Height	25 mm / 0.984 inches
Depth	49.2 mm / 1.937 inches

Mechanical data

Variable coding	Yes
Anti-rotation protection	Yes

Plug-in connection

Contact type (pluggable connector)	Male connector/plug
Connector (connection type)	for conductor
Mismating protection	Yes

Material data

Note (material data)	Information on material specifications can be found here
Color	light gray
Material group	I
Insulation material (main housing)	Polyamide (PA66)
Flammability class per UL94	V0
Clamping spring material	Chrome-nickel spring steel (CrNi)
Contact material	Electrolytic copper (E _{Cu})
Contact Plating	Tin
Fire load	0.253 MJ
Actuator color	orange
Weight	13.9 g

Environmental requirements

Limit temperature range	-60 ... +105 °C
Processing temperature	-35 ... +60 °C

Commercial data

PU (SPU)	48 pcs
Packaging type	Box
Country of origin	PL
GTIN	4055143986786
Customs tariff number	85366930000

Product Classification

UNSPSC	39121409
ETIM 9.0	EC001284
ETIM 10.0	EC001284
ECCN	NO US CLASSIFICATION

Environmental Product Compliance

RoHS Compliance Status	Compliant, No Exemption
------------------------	-------------------------

Approvals / Certificates

General approvals



Approval	Standard	Certificate Name
CB DEKRA Certification B.V.	IEC 61984	NL-124478
CSA DEKRA Certification B.V.	C22.2	1466354
DEKRA DEKRA Certification B.V.	EN 61984	71-173515
KEMA/KEUR DEKRA Certification B.V.	EN 61984	71-129589 REV.1
UR Underwriters Laboratories Inc.	UL 1059	UL-US-2426356-0

Downloads

Environmental Product Compliance

Compliance Search

Environmental Product
Compliance 831-1202



Documentation

Additional Information

Technical Section	03.04.2019	pdf 2027.26 KB	
-------------------	------------	-------------------	--

CAD/CAE-Data

CAD data	CAE data
2D/3D Models 831-1202	ZUKEN Portal 831-1202

1 Compatible Products

1.1 System counterpart

1.1.1 Female connector/socket



Item No.: 831-1102
1-conductor female connector; lever; Push-in CAGE CLAMP®; 10 mm²; Pin spacing 7.62 mm; 2-pole; 100% protected against mis-mating; 10,00 mm²; light gray



Item No.: 831-1102/000-004
1-conductor female connector; lever; Push-in CAGE CLAMP®; 10 mm²; Pin spacing 7.62 mm; 2-pole; 100% protected against mis-mating; black



Item No.: 831-1102/322-000
1-conductor female connector; lever; Push-in CAGE CLAMP®; 10 mm²; Pin spacing 7.62 mm; 2-pole; 100% protected against mis-mating; Centered locking levers; 10,00 mm²; light gray



Item No.: 831-1102/322-004
1-conductor female connector; lever; Push-in CAGE CLAMP®; 10 mm²; Pin spacing 7.62 mm; 2-pole; 100% protected against mis-mating; Centered locking levers; black



Item No.: 831-1102/306-000
1-conductor female connector; lever; Push-in CAGE CLAMP®; 10 mm²; Pin spacing 7.62 mm; 2-pole; 100% protected against mis-mating; DIN-35 rail/panel mounting; 10,00 mm²; light gray



Item No.: 831-1102/133-000
1-conductor female connector; lever; Push-in CAGE CLAMP®; 10 mm²; Pin spacing 7.62 mm; 2-pole; 100% protected against mis-mating; Gripping plate; 10,00 mm²; light gray



Item No.: 831-1102/037-000
1-conductor female connector; lever; Push-in CAGE CLAMP®; 10 mm²; Pin spacing 7.62 mm; 2-pole; 100% protected against mis-mating; Lateral locking levers; 10,00 mm²; light gray



Item No.: 831-1102/038-000
1-conductor female connector; lever; Push-in CAGE CLAMP®; 10 mm²; Pin spacing 7.62 mm; 2-pole; 100% protected against mis-mating; Lateral locking levers; 10,00 mm²; light gray



Item No.: 831-1102/038-000/306-000
1-conductor female connector; lever; Push-in CAGE CLAMP®; 10 mm²; Pin spacing 7.62 mm; 2-pole; 100% protected against mis-mating; Lateral locking levers; DIN-35 rail/panel mounting; 10,00 mm²; light gray



Item No.: 831-3522
THT female header; angled; Pin spacing 7.62 mm; 2-pole; 100% protected against mis-mating; 1.0 x 1.2 mm solder pin; light gray



Item No.: 831-3502
THT female header; straight; Pin spacing 7.62 mm; 2-pole; 100% protected against mis-mating; 1.0 x 1.2 mm solder pin; light gray

1.2 Optional Accessories

1.2.1 Ferrule

1.2.1.1 Ferrule



Item No.: 216-262
Ferrule; Sleeve for 0.75 mm² / 18 AWG; insulated; electro-tin plated; electrolytic copper; gastight crimped; acc. to DIN 46228, Part 4/09.90; gray



Item No.: 216-263
Ferrule; Sleeve for 1 mm² / AWG 18; insulated; electro-tin plated; electrolytic copper; gastight crimped; acc. to DIN 46228, Part 4/09.90; red



Item No.: 216-264
Ferrule; Sleeve for 1.5 mm² / AWG 16; insulated; electro-tin plated; electrolytic copper; gastight crimped; acc. to DIN 46228, Part 4/09.90; black



Item No.: 216-266
Ferrule; Sleeve for 2.5 mm² / AWG 14; insulated; electro-tin plated; electrolytic copper; gastight crimped; acc. to DIN 46228, Part 4/09.90; blue



Item No.: 216-267
Ferrule; Sleeve for 4 mm² / AWG 12; insulated; electro-tin plated; electrolytic copper; gastight crimped; acc. to DIN 46228, Part 4/09.90; gray



Item No.: 216-208
Ferrule; Sleeve for 6 mm² / AWG 10; insulated; electro-tin plated; electrolytic copper; gastight crimped; acc. to DIN 46228, Part 4/09.90; yellow



Item No.: 216-108
Ferrule; Sleeve for 6 mm² / AWG 10; uninsulated; electro-tin plated; silver-colored

1.2.2 Installation

1.2.2.1 Snap-in frame



Item No.: 831-302

Snap-in frame; for male connectors; 1 part;
Pin spacing 7.62 mm; 2-pole; light gray

1.2.3 Mounting adapter

1.2.3.1 Mounting accessories



Item No.: 831-1038

Mounting adapter; for DIN-35 rail/panel
mounting; fixed on DIN-rail 35; Pin spacing
7.62 mm; light gray



Item No.: 831-1032

Mounting adapter; for DIN-35 rail/panel
mounting; freely movable on DIN-rail 35; Pin
spacing 7.62 mm; light gray

1.2.4 Strain relief

1.2.4.1 Strain relief plate



Item No.: 831-503

Strain relief plate; for female and male con-
nectors; 15 mm wide; 1 part; Pin spacing 7.62
mm; light gray

Installation Notes

Conductor termination

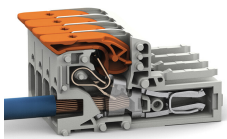

Insert solid conductors via push-in termina-
tion.

Conductor removal

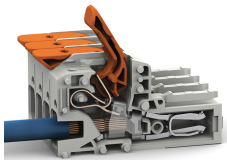

Insert fine-stranded conductors – and re-
move all conductors – via operating tool.