

Data Sheet | Item Number: 734-137

THT male header; 1.0 x 1.0 mm solder pin; straight; 100% protected against mismatching; Pin spacing 3.5 mm; 7-pole; light gray

<https://www.wago.com/734-137>



Color: ■ light gray

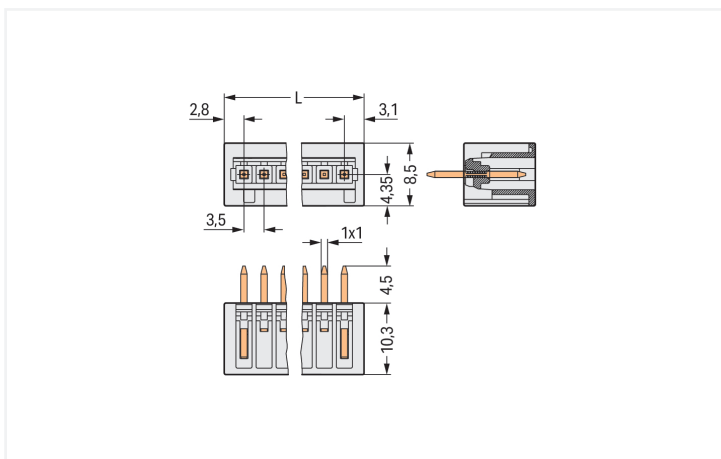

Dimensions in mm

$L = (\text{pole no.} - 1) \times \text{pin spacing} + 5.9 \text{ mm}$

Male connector, 734 Series, solder pin dimensions 1 x 1 mm

Our male connector (item number 734-137) simplifies electrical installations. The dimensions are (26.9 x 14.8 x 8.5) mm (width x height x depth).

The contact surface is coated with tin. The pcb connector is designed for THT soldering.

Notes

Safety Information

The MCS – MULTI CONNECTION SYSTEM includes connectors without breaking capacity in accordance with DIN EN 61984. When used as intended, these connectors must not be connected/disconnected when live or under load. When used as intended, these connectors must not be connected/disconnected when live or under load. The circuit design should ensure header pins, which can be touched, are not live when unmated.

Variants:

Other pole numbers
3.8 mm pin projection for male headers with straight solder pins
Gold-plated or partially gold-plated contact surfaces
Other versions (or variants) can be requested from WAGO Sales or configured at <https://configurator.wago.com/>.

Electrical data

Ratings per	IEC/EN 60664-1		
Overvoltage category	III	III	II
Pollution degree	3	2	2
Nominal voltage	160 V	160 V	320 V
Rated impulse withstand voltage	2.5 kV	2.5 kV	2.5 kV
Rated current	10 A	10 A	10 A

Approvals per	UL 1059		
Use group	B	C	D
Rated voltage	300 V	-	300 V
Rated current	10 A	-	10 A

Approvals per	CSA		
Use group	B	C	D
Rated voltage	300 V	-	300 V
Rated current	10 A	-	10 A

Connection Data

Total number of potentials	7
Number of connection types	1
Number of levels	1

Connection 1

Pole number	7
-------------	---

Physical data

Pin spacing	3.5 mm / 0.138 inches
Width	26.9 mm / 1.059 inches
Height	14.8 mm / 0.583 inches
Height from the surface	10.3 mm / 0.406 inches
Depth	8.5 mm / 0.335 inches
Solder pin length	4.5 mm
Solder pin dimensions	1 x 1 mm
Drilled hole diameter	1.4 ^(+0.1) mm

Mechanical data

Variable coding	Yes
Anti-rotation protection	Yes

Plug-in connection

Contact type (pluggable connector)	Male connector/plug
Connector (connection type)	for PCB
Mismating protection	Yes
Mating direction to the PCB	90 °

PCB contact

PCB contact	THT
Solder pin arrangement	over the entire male connector (in-line)
Number of solder pins per potential	1

Material data

Note (material data)	Information on material specifications can be found here
Color	light gray
Material group	I
Insulation material (main housing)	Polyamide (PA66)
Flammability class per UL94	V0
Contact material	Electrolytic copper (E _{Cu})
Contact Plating	Tin
Fire load	0.025 MJ
Weight	1.7 g

Environmental requirements

Limit temperature range	-60 ... +100 °C
Processing temperature	-35 ... +60 °C

Environmental Testing

Test specification: Railway applications – Rolling stock – Electronic equipment	DIN EN 50155 (VDE 0115-200):2022-06
Test procedure: Railway applications – Rolling stock equipment – Vibration and shock tests	DIN EN 61373 (VDE 0115-0106):2011-04
Spectrum/Mounting location	Service life test, Category 1, Class A/B
Functional test with noise-like oscillations	Test passed according to Section 8 of the standard
Frequency	f ₁ = 5 Hz to f ₂ = 150 Hz
Acceleration	0.101g (highest test level used for all axes)
Test duration per axis	10 min.
Test directions	X, Y and Z axes
Monitoring of contact faults and interruptions	Passed
Voltage drop measurement before and after each axis	Passed
Simulated service life test through increased levels of noise-like oscillations	Test passed according to Section 9 of the standard
Frequency	f ₁ = 5 Hz to f ₂ = 150 Hz
Acceleration	0.572g (highest test level used for all axes)
Test duration per axis	5 h
Test directions	X, Y and Z axes
Extended testing: Monitoring of contact faults and interruptions	Passed
Extended testing: Voltage drop measurement before and after each axis	Passed
Shock test	Test passed according to Section 10 of the standard
Shock pulse form	Half sine

Environmental Testing

Acceleration	5g (highest test level used for all axes)
Shock duration	30 ms
Number of shocks (per axis)	3 pos. und 3 neg.
Test directions	X, Y and Z axes
Extended testing: Monitoring of contact faults and interruptions	Passed
Extended testing: Voltage drop measurement before and after each axis	Passed
Vibration and shock stress for rolling stock equipment	Passed

Commercial data

Product Group	3 (Multi Conn. System)
PU (SPU)	100 pcs
Packaging type	Box
Country of origin	PL
GTIN	4044918847629
Customs tariff number	85366930000

Product Classification

UNSPSC	39121409
eCl@ss 10.0	27-44-04-02
eCl@ss 9.0	27-44-04-02
ETIM 9.0	EC002637
ETIM 10.0	EC002637
ECCN	NO US CLASSIFICATION

Environmental Product Compliance

RoHS Compliance Status	Compliant, No Exemption
------------------------	-------------------------

Approvals / Certificates

General approvals



Approval	Standard	Certificate Name
CCA DEKRA Certification B.V.	EN 61984	2169534.02
CCA DEKRA Certification B.V.	EN 61984	nl-54190
CSA DEKRA Certification B.V.	C22.2	1465035
UL Underwriters Laboratories Inc.	UL 1977	E 45171

Declarations of conformity and manufacturer's declarations



Approval	Standard	Certificate Name
Railway WAGO GmbH & Co. KG	-	Railway Ready

Approvals for marine applications



Approval	Standard	Certificate Name
ABS American Bureau of Ship- ping	-	24-0095975-PDA
DNV DNV GL SE	-	TAE000016Z
LR Lloyds Register	IEC 61984	96/20035 (E5)
PRS Polski Rejestr Statków	-	TE/1095/880590/23

Downloads

Environmental Product Compliance

Compliance Search
Environmental Product Compliance 734-137 ↓

Documentation

Additional Information			
Technical Section	03.04.2019	pdf 2027.26 KB	↓

CAD/CAE-Data

CAD data
2D/3D Models 734-137 ↓

CAE data
EPLAN Data Portal 734-137 ↓
ZUKEN Portal 734-137 ↓

























PCB Design

Symbol and Footprint via SamacSys 734-137 ↓
Symbol and Footprint via Ultra Librarian 734-137 ↓

1 Compatible Products

1.1 System counterpart

1.1.1 Female connector/socket

 <p>Item No.: 734-104/033-000 1-conductor female connector; CAGE CLAMP®; 1.5 mm²; Pin spacing 3.5 mm; 4-pole; 100% protected against mismatching; Strain relief plate; light gray</p>	 <p>Item No.: 734-105/033-000 1-conductor female connector; CAGE CLAMP®; 1.5 mm²; Pin spacing 3.5 mm; 5-pole; 100% protected against mismatching; Strain relief plate; light gray</p>	 <p>Item No.: 734-106/033-000 1-conductor female connector; CAGE CLAMP®; 1.5 mm²; Pin spacing 3.5 mm; 6-pole; 100% protected against mismatching; Strain relief plate; light gray</p>	 <p>Item No.: 734-107/037-000 1-conductor female connector; CAGE CLAMP®; 1.5 mm²; Pin spacing 3.5 mm; 7-pole; 100% protected against mismatching; Lateral locking levers; light gray</p>
 <p>Item No.: 734-107/037-000/033-000 1-conductor female connector; CAGE CLAMP®; 1.5 mm²; Pin spacing 3.5 mm; 7-pole; 100% protected against mismatching; Lateral locking levers; Strain relief plate; 1,50 mm²; light gray</p>	 <p>Item No.: 734-107 1-conductor female connector; CAGE CLAMP®; 1.5 mm²; Pin spacing 3.5 mm; 7-pole; 100% protected against mismatching; light gray</p>	 <p>Item No.: 734-107/033-000 1-conductor female connector; CAGE CLAMP®; 1.5 mm²; Pin spacing 3.5 mm; 7-pole; 100% protected against mismatching; Strain relief plate; light gray</p>	 <p>Item No.: 734-108/033-000 1-conductor female connector; CAGE CLAMP®; 1.5 mm²; Pin spacing 3.5 mm; 8-pole; 100% protected against mismatching; Strain relief plate; light gray</p>
 <p>Item No.: 734-109/033-000 1-conductor female connector; CAGE CLAMP®; 1.5 mm²; Pin spacing 3.5 mm; 9-pole; 100% protected against mismatching; Strain relief plate; light gray</p>	 <p>Item No.: 2734-1107/327-000 1-conductor female connector; lever; Push-in CAGE CLAMP®; 1.5 mm²; Pin spacing 3.5 mm; 7-pole; 100% protected against mismatching; 1,50 mm²; light gray</p>	 <p>Item No.: 2734-1107/328-000 1-conductor female connector; lever; Push-in CAGE CLAMP®; 1.5 mm²; Pin spacing 3.5 mm; 7-pole; 100% protected against mismatching; Centered locking levers; 1,50 mm²; light gray</p>	 <p>Item No.: 2734-1107/328-000/334-000 1-conductor female connector; lever; Push-in CAGE CLAMP®; 1.5 mm²; Pin spacing 3.5 mm; 7-pole; 100% protected against mismatching; Centered locking levers; Strain relief plate; 1,50 mm²; light gray</p>
 <p>Item No.: 2734-1107/327-047 1-conductor female connector; lever; Push-in CAGE CLAMP®; 1.5 mm²; Pin spacing 3.5 mm; 7-pole; 100% protected against mismatching; direct marking; 1,50 mm²; light gray</p>	 <p>Item No.: 2734-1107/327-9037 1-conductor female connector; lever; Push-in CAGE CLAMP®; 1.5 mm²; Pin spacing 3.5 mm; 7-pole; 100% protected against mismatching; direct marking; 1,50 mm²; light gray</p>	 <p>Item No.: 2734-1107/038-000 1-conductor female connector; lever; Push-in CAGE CLAMP®; 1.5 mm²; Pin spacing 3.5 mm; 7-pole; 100% protected against mismatching; Lateral locking levers; 1,50 mm²; light gray</p>	 <p>Item No.: 2734-1107/038-000/334-000 1-conductor female connector; lever; Push-in CAGE CLAMP®; 1.5 mm²; Pin spacing 3.5 mm; 7-pole; 100% protected against mismatching; Lateral locking levers; Strain relief plate; 1,50 mm²; light gray</p>
 <p>Item No.: 2734-1107/327-000/334-000 1-conductor female connector; lever; Push-in CAGE CLAMP®; 1.5 mm²; Pin spacing 3.5 mm; 7-pole; 100% protected against mismatching; Strain relief plate; 1,50 mm²; light gray</p>	 <p>Item No.: 2734-107/031-000 1-conductor female connector; push-button; Push-in CAGE CLAMP®; 1.5 mm²; Pin spacing 3.5 mm; 7-pole; 100% protected against mismatching; clamping collar; light gray</p>	 <p>Item No.: 2734-107/037-000 1-conductor female connector; push-button; Push-in CAGE CLAMP®; 1.5 mm²; Pin spacing 3.5 mm; 7-pole; 100% protected against mismatching; Lateral locking levers; light gray</p>	 <p>Item No.: 2734-107 1-conductor female connector; push-button; Push-in CAGE CLAMP®; 1.5 mm²; Pin spacing 3.5 mm; 7-pole; 100% protected against mismatching; light gray</p>
 <p>Item No.: 734-537 THT female header; angled; Pin spacing 3.5 mm; 7-pole; 100% protected against mismatching; 0.9 x 0.9 mm solder pin; light gray</p>	 <p>Item No.: 734-537/037-000 THT female header; angled; Pin spacing 3.5 mm; 7-pole; 100% protected against mismatching; Locking lever; 0.9 x 0.9 mm solder pin; light gray</p>	 <p>Item No.: 734-467 THT female header; straight; Pin spacing 3.5 mm; 7-pole; 100% protected against mismatching; 0.9 x 0.9 mm solder pin; light gray</p>	 <p>Item No.: 734-467/037-000 THT female header; straight; Pin spacing 3.5 mm; 7-pole; 100% protected against mismatching; Locking lever; 0.9 x 0.9 mm solder pin; light gray</p>

1.2 Optional Accessories

1.2.1 Coding

1.2.1.1 Coding

<p>Item No.: 734-159 Coding key; to be snapped above top level; black</p>	<p>Item No.: 734-130 Coding key; to be snapped above top level; white</p>
--	--

Installation Notes

Coding

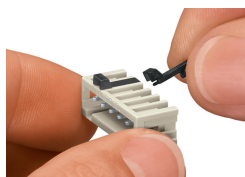

Coding a male header – fitting coding key (s).