

Data Sheet | Item Number: 734-116

1-conductor female connector; CAGE CLAMP®; 1.5 mm²; Pin spacing 3.5 mm; 16-pole;
100% protected against mismatching; light gray

<https://www.wago.com/734-116>

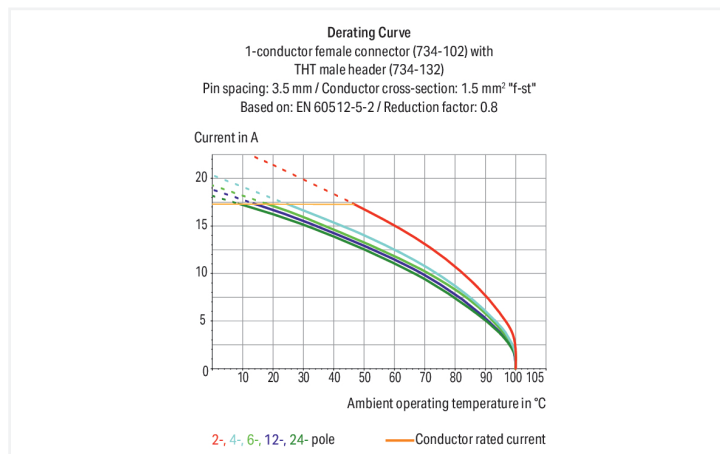

Color: ■ light gray

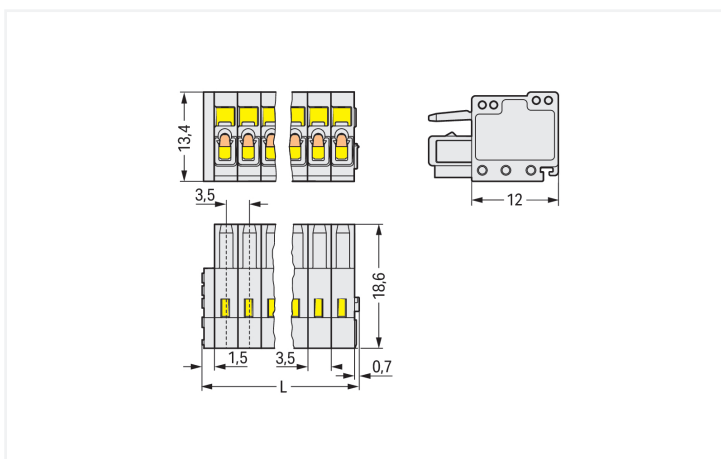

Dimensions in mm

L = (pole no. x pin spacing) + 2.2 mm

Female connector, 734 Series, operating tool

This female connector (item number 734-116) simplifies electrical installations. Strip lengths must be between 6 and 7 mm when connecting conductors to this female connector. This product features one conductor terminal and utilizes CAGE CLAMP®. Our reliable and maintenance-free CAGE CLAMP® connection makes it easy to connect all conductor types without having to prepare the conductor. For example, you don't need to crimp ferrules. The item's dimensions are (58.2 x 13.4 x 18.6) mm (width x height x depth). This female connector is suitable for conductor cross sections ranging from 0.08 mm² to 1.5 mm².

The contact surface is coated with tin.

Notes

Safety Information

The MCS – MULTI CONNECTION SYSTEM includes connectors without breaking capacity in accordance with DIN EN 61984. When used as intended, these connectors must not be connected/disconnected when live or under load. When used as intended, these connectors must not be connected/disconnected when live or under load. The circuit design should ensure header pins, which can be touched, are not live when unmated.

Variants:

Other pole numbers
Gold-plated or partially gold-plated contact surfaces
Other versions (or variants) can be requested from WAGO Sales or configured at <https://configurator.wago.com/>.

Electrical data

Ratings per	IEC/EN 60664-1		
Oversvoltage category	III	III	II
Pollution degree	3	2	2
Nominal voltage	160 V	160 V	320 V
Rated impulse withstand voltage	2.5 kV	2.5 kV	2.5 kV
Rated current	10 A	10 A	10 A

Approvals per	UL 1059		
Use group	B	C	D
Rated voltage	300 V	-	300 V
Rated current	10 A	-	10 A

Approvals per	CSA		
Use group	B	C	D
Rated voltage	300 V	-	300 V
Rated current	10 A	-	10 A

Connection Data

Clamping units	16
Total number of potentials	16
Number of connection types	1
Number of levels	1

Connection 1	
Connection technology	CAGE CLAMP®
Actuation type	Operating tool
Actuation direction 1	Operation parallel to conductor entry
Actuation direction 2	Operation perpendicular to conductor entry
Solid conductor	0.08 ... 1.5 mm ² / 28 ... 14 AWG
Fine-stranded conductor	0.08 ... 1.5 mm ² / 28 ... 14 AWG
Fine-stranded conductor; with insulated ferrule	0.25 ... 1.5 mm ²
Fine-stranded conductor; with uninsulated ferrule	0.25 ... 1.5 mm ²
Note (conductor cross-section)	Terminating 1.5 mm ² conductors is possible; however insulation diameter does not allow clamping units to be terminated in a row.
Strip length	6 ... 7 mm / 0.24 ... 0.28 inches
Pole number	16
Conductor entry direction to mating direction	0°

Physical data

Pin spacing	3.5 mm / 0.138 inches
Width	58.2 mm / 2.291 inches
Height	13.4 mm / 0.528 inches
Depth	18.6 mm / 0.732 inches

Mechanical data

Variable coding	Yes
Anti-rotation protection	Yes

Plug-in connection

Contact type (pluggable connector)	Female connector/socket
Connector (connection type)	for conductor
Mismating protection	Yes

Material data

Note (material data)	Information on material specifications can be found here
Color	light gray
Material group	I
Insulation material (main housing)	Polyamide (PA66)
Flammability class per UL94	V0
Clamping spring material	Chrome-nickel spring steel (CrNi)
Contact material	Copper alloy
Contact Plating	Tin
Fire load	0.165 MJ
Weight	11.9 g

Environmental requirements

Limit temperature range	-60 ... +100 °C
Processing temperature	-35 ... +60 °C

Environmental Testing

Test specification: Railway applications – Rolling stock – Electronic equipment	DIN EN 50155 (VDE 0115-200):2022-06
Test procedure: Railway applications – Rolling stock equipment – Vibration and shock tests	DIN EN 61373 (VDE 0115-0106):2011-04
Spectrum/Mounting location	Service life test, Category 1, Class A/B
Functional test with noise-like oscillations	Test passed according to Section 8 of the standard
Frequency	$f_1 = 5 \text{ Hz}$ to $f_2 = 150 \text{ Hz}$
Acceleration	0.101g (highest test level used for all axes)
Test duration per axis	10 min.
Test directions	X, Y and Z axes
Monitoring of contact faults and interruptions	Passed
Voltage drop measurement before and after each axis	Passed
Simulated service life test through increased levels of noise-like oscillations	Test passed according to Section 9 of the standard
Frequency	$f_1 = 5 \text{ Hz}$ to $f_2 = 150 \text{ Hz}$
Acceleration	0.572g (highest test level used for all axes)
Test duration per axis	5 h
Test directions	X, Y and Z axes
Extended testing: Monitoring of contact faults and interruptions	Passed
Extended testing: Voltage drop measurement before and after each axis	Passed
Shock test	Test passed according to Section 10 of the standard
Shock pulse form	Half sine
Acceleration	5g (highest test level used for all axes)
Shock duration	30 ms

Environmental Testing

Number of shocks (per axis)	3 pos. und 3 neg.
Test directions	X, Y and Z axes
Extended testing: Monitoring of contact faults and interruptions	Passed
Extended testing: Voltage drop measurement before and after each axis	Passed
Vibration and shock stress for rolling stock equipment	Passed

Commercial data

Product Group	3 (Multi Conn. System)
PU (SPU)	25 pcs
Packaging type	Box
Country of origin	DE
GTIN	4044918493901
Customs tariff number	85366990990

Product Classification

UNSPSC	39121409
eCl@ss 10.0	27-44-03-09
eCl@ss 9.0	27-44-03-09
ETIM 9.0	EC002638
ETIM 10.0	EC002638
ECCN	NO US CLASSIFICATION

Environmental Product Compliance

RoHS Compliance Status	Compliant, No Exemption
------------------------	-------------------------

Approvals / Certificates

General approvals



Approval	Standard	Certificate Name
CCA DEKRA Certification B.V.	EN 61984	2169534.02
CCA DEKRA Certification B.V.	EN 61984	nl-54190
CSA DEKRA Certification B.V.	C22.2	1465035
UL Underwriters Laboratories Inc.	UL 1977	E 45171

Declarations of conformity and manufacturer's declarations



Approval	Standard	Certificate Name
Railway WAGO GmbH & Co. KG	-	Railway Ready

Approvals for marine applications



Approval	Standard	Certificate Name
ABS American Bureau of Shipping	-	24-0095975-PDA
DNV DNV GL SE	-	TAE000016Z
LR Lloyds Register	IEC 61984	96/20035 (E5)
PRS Polski Rejestr Statków	-	TE/1095/880590/23

Downloads

Environmental Product Compliance

Compliance Search
Environmental Product Compliance 734-116

Documentation

Additional Information
Technical Section 03.04.2019 pdf 2027.26 KB

CAD/CAE-Data

CAD data
2D/3D Models 734-116

CAE data
EPLAN Data Portal 734-116
ZUKEN Portal 734-116

1 Compatible Products

1.1 System counterpart

1.1.1 Male connector/plug

 Item No.: 734-316/019-000 1-conductor male connector; CAGE CLAMP®; 1.5 mm²; Pin spacing 3.5 mm; 16-pole; 100% protected against mismatching; clamping collar; light gray	 Item No.: 734-316/018-000 1-conductor male connector; CAGE CLAMP®; 1.5 mm²; Pin spacing 3.5 mm; 16-pole; 100% protected against mismatching; DIN-35 rail/panel mounting; Snap-in mounting feet; light gray	 Item No.: 734-316 1-conductor male connector; CAGE CLAMP®; 1.5 mm²; Pin spacing 3.5 mm; 16-pole; 100% protected against mismatching; light gray	 Item No.: 734-176/105-604/997-408 THR male header; 1.0 x 1.0 mm solder pin; angled; 100% protected against mismatching; in tape-and-reel packaging; Pin spacing 3.5 mm; 16-pole; black
 Item No.: 734-176/105-604 THR male header; 1.0 x 1.0 mm solder pin; angled; 100% protected against mismatching; Pin spacing 3.5 mm; 16-pole; black	 Item No.: 734-146/105-604/997-408 THR male header; 1.0 x 1.0 mm solder pin; straight; 100% protected against mismatching; in tape-and-reel packaging; Pin spacing 3.5 mm; 16-pole; black	 Item No.: 734-146/105-604 THR male header; 1.0 x 1.0 mm solder pin; straight; 100% protected against mismatching; Pin spacing 3.5 mm; 16-pole; black	 Item No.: 734-176 THT male header; 1.0 x 1.0 mm solder pin; angled; 100% protected against mismatching; Pin spacing 3.5 mm; 16-pole; light gray

1.1.1 Male connector/plug



Item No.: 734-146/010-000

THT male header; 1.0 x 1.0 mm solder pin; straight; 100% protected against mismatching; Gold-plated contacts; Pin spacing 3.5 mm; 16-pole; light gray

Item No.: 734-146

THT male header; 1.0 x 1.0 mm solder pin; straight; 100% protected against mismatching; Pin spacing 3.5 mm; 16-pole; light gray

Item No.: 734-146/046-000

THT male header; 1.0 x 1.0 mm solder pin; straight; 100% protected against mismatching; Pin spacing 3.5 mm; 16-pole; light gray

1.2 Optional Accessories

1.2.1 Ferrule

1.2.1.1 Ferrule



Item No.: 216-321

Ferrule; Sleeve for 0.25 mm² / AWG 24; insulated; electro-tin plated; yellow

Item No.: 216-131

Ferrule; Sleeve for 0.25 mm² / AWG 24; uninsulated; electro-tin plated; silver-colored

Item No.: 216-322

Ferrule; Sleeve for 0.34 mm² / 22 AWG; insulated; electro-tin plated; light turquoise

Item No.: 216-132

Ferrule; Sleeve for 0.34 mm² / 22 AWG; uninsulated; electro-tin plated



Item No.: 216-221

Ferrule; Sleeve for 0.5 mm² / 20 AWG; insulated; electro-tin plated; white

Item No.: 216-121

Ferrule; Sleeve for 0.5 mm² / AWG 22; uninsulated; electro-tin plated; silver-colored

Item No.: 216-222

Ferrule; Sleeve for 0.75 mm² / 18 AWG; insulated; electro-tin plated; gray

Item No.: 216-122

Ferrule; Sleeve for 0.75 mm² / 18 AWG; uninsulated; electro-tin plated; silver-colored



Item No.: 216-223

Ferrule; Sleeve for 1 mm² / AWG 18; insulated; electro-tin plated; red

Item No.: 216-123

Ferrule; Sleeve for 1 mm² / AWG 18; uninsulated; electro-tin plated; silver-colored

Item No.: 216-224

Ferrule; Sleeve for 1.5 mm² / AWG 16; insulated; electro-tin plated; black

Item No.: 216-124

Ferrule; Sleeve for 1.5 mm² / AWG 16; uninsulated; electro-tin plated

1.2.2 Insulation stop

1.2.2.1 Insulation stop



Item No.: 734-671

Insulation stop; 0.08 - 0.2 mm² "s" (0.14 mm² "f-st"); 8 pieces/strip; light gray

1.2.3 Marking

1.2.3.1 Marking strip



Item No.: 210-332/350-202

Marking strips; as a DIN A4 sheet; MARKED; 1-16 (240x); Height of marker strip: 3 mm; Strip length 182 mm; Horizontal marking; Self-adhesive; white

Item No.: 210-332/350-204

Marking strips; as a DIN A4 sheet; MARKED; 17-32 (240x); Height of marker strip: 3 mm; Strip length 182 mm; Horizontal marking; Self-adhesive; white

Item No.: 210-332/350-206

Marking strips; as a DIN A4 sheet; MARKED; 33-48 (240x); Height of marker strip: 3 mm; Strip length 182 mm; Horizontal marking; Self-adhesive; white

1.2.4 Strain relief

1.2.4.1 Strain relief plate

Item No.: 734-126

Strain relief plate; for female and male connectors; 35 mm wide; 1 part; Pin spacing 3.5 mm; light gray

1.2.5 Test and measurement

1.2.5.1 Testing accessories

Item No.: 735-500

WAGO Test pin; 1 mm Ø; 30 V AC / 60 V DC; CAT0; 1 A; 6 mm uninsulated; Test lead for soldering up to 0,5mm²

1.2.6 Tool

1.2.6.1 Operating tool

Item No.: 734-190

Combination operating tool; natural

Item No.: 734-231

Operating tool; black

Item No.: 210-719

Operating tool; Blade: 2.5 x 0.4 mm; with a partially insulated shaft

Item No.: 210-647

Operating tool; Blade: 2.5 x 0.4 mm; with a partially insulated shaft; multicoloured

Item No.: 210-251

Operating tool; for MCS MICRO and MINI with CAGE CLAMP® connection; yellow

Item No.: 210-250

Operating tool; for MCS MINI and MIDI with CAGE CLAMP® connection; red

Item No.: 734-191

Operating tool; made of insulating material; 1-way; loose; black

Item No.: 734-230

Operating tool; made of insulating material; 1-way; white

Installation Notes

Conductor termination

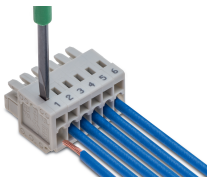

Inserting a conductor via (2.5 x 0.4) mm screwdriver – CAGE CLAMP® actuation perpendicular to conductor entry.



Inserting a conductor via (2.5 x 0.4) mm screwdriver – CAGE CLAMP® actuation parallel to conductor entry.

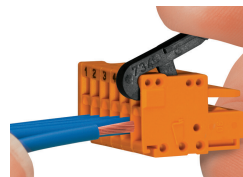

Inserting a conductor into CAGE CLAMP® unit via operating tool (734-191).

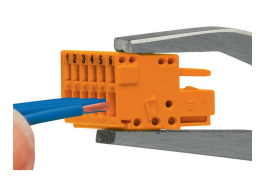

Inserting a conductor into CAGE CLAMP® unit via operating tool (210-251 or 210-250).

Coding

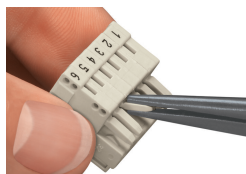

Coding a female connector – removing coding finger(s).

Testing

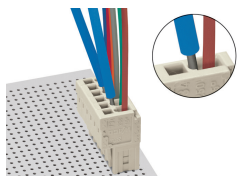

Testing via 1 mm Ø test pin (735-500) – CAGE CLAMP® connection – touch contact.

Marking

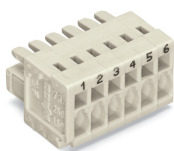

Labeling via direct marking or self-adhesive strips.

Installation

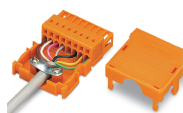

Strain relief housing for 734 Series Male and Female Connectors with CAGE CLAMP® connection