

Data Sheet | Item Number: 713-1107/037-000

1-conductor female connector, 2-row; CAGE CLAMP®; 1.5 mm²; Pin spacing 3.5 mm; 14-pole; 100% protected against mismatching; Levers; black

<https://www.wago.com/713-1107/037-000>

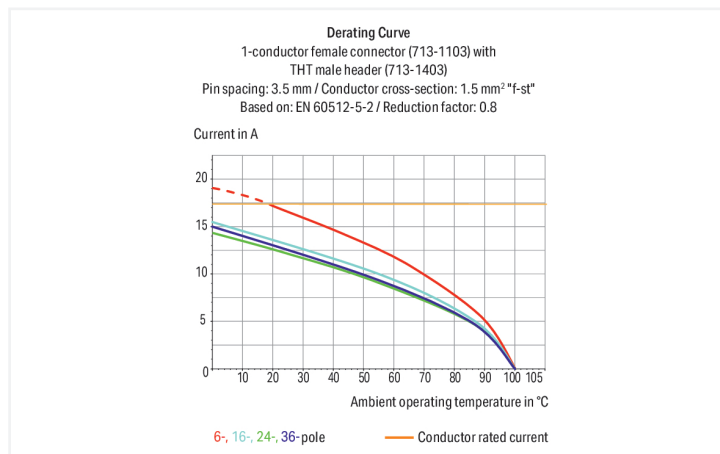

Color: ■ black

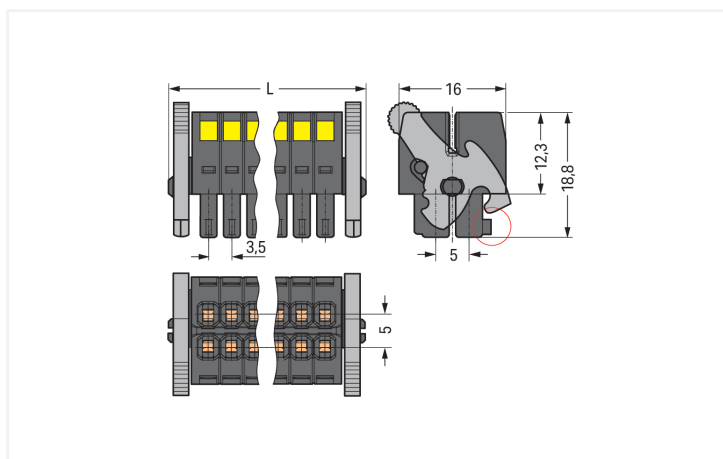

Dimensions in mm

$L = [(pole\ no./2) - 1] \times pin\ spacing + 12.2\ mm$ Coding finger (red circle)

Female connector, 713 Series, 0° conductor exit to connection direction

This female connector (item number 713-1107/037-000) simplifies electrical installations. Conductors can only be connected to this female connector if their strip length is between 6 and 7 mm. This product features one conductor terminal and utilizes CAGE CLAMP®. Our renowned universal connection known as CAGE CLAMP® is the industry standard when it comes to connection technology and electrical interconnections. Dimensions: (33.2 x 16.5 x 22.3) mm (width x height x depth). Depending on the conductor type, this female connector is designed for conductor cross sections ranging from 0.08 mm² to 1.5 mm².

Tin is used for coating the contact surfaces.

Notes

Safety Information

The MCS – MULTI CONNECTION SYSTEM includes connectors without breaking capacity in accordance with DIN EN 61984. When used as intended, these connectors must not be connected/disconnected when live or under load. When used as intended, these connectors must not be connected/disconnected when live or under load. The circuit design should ensure header pins, which can be touched, are not live when unmated.

Variants:

Other pole numbers
Gold-plated or partially gold-plated contact surfaces
Other versions (or variants) can be requested from WAGO Sales or configured at <https://configurator.wago.com/>.

Electrical data

Ratings per	IEC/EN 60664-1		
Overvoltage category	III	III	II
Pollution degree	3	2	2
Nominal voltage	80 V	160 V	250 V
Rated impulse withstand voltage	2.5 kV	2.5 kV	2.5 kV
Rated current	10 A	10 A	10 A

Approvals per	UL 1059		
Use group	B	C	D
Rated voltage	300 V	50 V	-
Rated current	10 A	10 A	-

Approvals per	CSA		
Use group	B	C	D
Rated voltage	300 V	-	-
Rated current	10 A	-	-

Connection Data

Clamping units	14
Total number of potentials	14
Number of connection types	1
Number of levels	2

Connection 1

Connection technology	CAGE CLAMP®
Actuation type	Operating tool
Actuation direction 1	Operation perpendicular to conductor entry
Solid conductor	0.08 ... 1.5 mm ² / 28 ... 16 AWG
Fine-stranded conductor	0.08 ... 1.5 mm ² / 28 ... 16 AWG
Fine-stranded conductor; with insulated ferrule	0.25 ... 1 mm ²
Fine-stranded conductor; with uninsulated ferrule	0.25 ... 1 mm ²
Strip length	6 ... 7 mm / 0.24 ... 0.28 inches
Pole number	14
Conductor entry direction to mating direction	0°

Physical data

Pin spacing	3.5 mm / 0.138 inches
Width	33.2 mm / 1.307 inches
Height	16.5 mm / 0.65 inches
Depth	22.3 mm / 0.878 inches

Mechanical data

Variable coding	Yes
Anti-rotation protection	Yes

Plug-in connection

Contact type (pluggable connector)	Female connector/socket
Connector (connection type)	for conductor
Mismating protection	Yes
Locking of plug-in connection	Locking lever

Material data

Note (material data)	Information on material specifications can be found here
Color	black
Material group	II
Insulation material (main housing)	Glass fiber-reinforced polyamide (PA66 GF)
Flammability class per UL94	V0
Clamping spring material	Chrome-nickel spring steel (CrNi)
Contact material	Copper alloy
Contact Plating	Tin
Fire load	0.087 MJ
Weight	8.2 g

Environmental requirements

Limit temperature range	-60 ... +100 °C
Processing temperature	-35 ... +60 °C

Commercial data

Product Group	3 (Multi Conn. System)
PU (SPU)	25 pcs
Packaging type	Box
Country of origin	PL
GTIN	4045454806200
Customs tariff number	85366990990

Product Classification

UNSPSC	39121409
eCl@ss 10.0	27-14-11-06
eCl@ss 9.0	27-14-11-06
ETIM 9.0	EC001284
ETIM 10.0	EC001284
ECCN	NO US CLASSIFICATION

Environmental Product Compliance

RoHS Compliance Status	Compliant, No Exemption
SCIP notification number (Austria)	7bf7a964-5c58-4457-b428-53941f7e63bf
SCIP notification number (Belgium)	baa58850-16ac-4676-95f4-1268d6c01870
SCIP notification number (Bulgaria)	e149ffa2-7184-4f0b-8da7-c85cdd706ab8
SCIP notification number (Czech Republic)	f63f1e3b-da38-44c9-b026-ab6593ec92ba
SCIP notification number (Denmark)	da0d56fc-2f22-43d0-a1e2-eb638789fd38
SCIP notification number (Finland)	5c02dc1a-eaf3-4d22-8484-5bc224bf00c5
SCIP notification number (France)	b9b1b6eb-baff-43a4-8bf0-07cc26f87d17
SCIP notification number (Germany)	d76f7c95-5bc8-4144-92b1-f7c14d9293fe
SCIP notification number (Hungary)	df989e0a-ad9b-4bef-a225-9b92a2c0323d
SCIP notification number (Italy)	3190b778-d14c-4f46-8627-5a8f81e44760
SCIP notification number (Netherlands)	78d7c1ad-9926-4fb7-9e7a-2b249ddf01ab
SCIP notification number (Poland)	08621f86-b03b-4adc-a197-dd0ace9c3d48
SCIP notification number (Romania)	74d92c07-6c66-452d-851e-cea09ceda599
SCIP notification number (Sweden)	97738525-428a-4fc1-9225-224dede6b6e8

Approvals / Certificates

General approvals			Declarations of conformity and manufacturer's declarations		
Approval	Standard	Certificate Name	Approval	Standard	Certificate Name
CB DEKRA Certification B.V.	IEC 61984	NL-102427	Railway WAGO GmbH & Co. KG	-	Z00004422.000
CSA CSA Group	C22.2	2315087			
KEMA/KEUR DEKRA Certification B.V.	EN 61984	71-133740			

Downloads

Environmental Product Compliance

Compliance Search	
Environmental Product Compliance 713-1107/037-000	↓

Documentation

Additional Information			
Technical Section	03.04.2019	pdf 2027.26 KB	↓

CAD/CAE-Data

CAD data
 2D/3D Models
 713-1107/037-000

CAE data
 ZUKEN Portal
 713-1107/037-000

1 Compatible Products

1.1 System counterpart

1.1.1 Male connector/plug



Item No.: 713-1427/116-000/997-407
 THR male header, 2-row; 0.8 x 0.8 mm solder pin; angled; 100% protected against mismatching; Levers; in tape-and-reel packaging; Pin spacing 3.5 mm; 14-pole; black

Item No.: 713-1427/116-000
 THR male header, 2-row; 0.8 x 0.8 mm solder pin; angled; 100% protected against mismatching; Levers; Pin spacing 3.5 mm; 14-pole; black

Item No.: 713-1407/116-000/997-407
 THR male header, 2-row; 0.8 x 0.8 mm solder pin; straight; 100% protected against mismatching; Levers; in tape-and-reel packaging; Pin spacing 3.5 mm; 14-pole; black

Item No.: 713-1407/116-000
 THR male header, 2-row; 0.8 x 0.8 mm solder pin; straight; 100% protected against mismatching; Levers; Pin spacing 3.5 mm; 14-pole; black



Item No.: 713-1427/037-000
 THT male header, 2-row; 0.8 x 0.8 mm solder pin; angled; 100% protected against mismatching; Levers; Pin spacing 3.5 mm; 14-pole; black

Item No.: 713-1407/037-000
 THT male header, 2-row; 0.8 x 0.8 mm solder pin; straight; 100% protected against mismatching; Levers; Pin spacing 3.5 mm; 14-pole; black

Item No.: 713-1467/037-000
 THT male header, 2-row; 0.8 x 0.8 mm solder pin; straight; 100% protected against mismatching; with orientation nose; Levers; Pin spacing 3.5 mm; 14-pole; black

1.2 Optional Accessories

1.2.1 Ferrule

1.2.1.1 Ferrule



Item No.: 216-321
 Ferrule; Sleeve for 0.25 mm² / AWG 24; insulated; electro-tin plated; yellow

Item No.: 216-131
 Ferrule; Sleeve for 0.25 mm² / AWG 24; uninsulated; electro-tin plated; silver-colored

Item No.: 216-322
 Ferrule; Sleeve for 0.34 mm² / 22 AWG; insulated; electro-tin plated; light turquoise

Item No.: 216-132
 Ferrule; Sleeve for 0.34 mm² / 22 AWG; uninsulated; electro-tin plated



Item No.: 216-221
 Ferrule; Sleeve for 0.5 mm² / 20 AWG; insulated; electro-tin plated; white

Item No.: 216-121
 Ferrule; Sleeve for 0.5 mm² / AWG 22; uninsulated; electro-tin plated; silver-colored

Item No.: 216-222
 Ferrule; Sleeve for 0.75 mm² / 18 AWG; insulated; electro-tin plated; gray

Item No.: 216-122
 Ferrule; Sleeve for 0.75 mm² / 18 AWG; uninsulated; electro-tin plated; silver-colored



Item No.: 216-223
 Ferrule; Sleeve for 1 mm² / AWG 18; insulated; electro-tin plated; red

Item No.: 216-123
 Ferrule; Sleeve for 1 mm² / AWG 18; uninsulated; electro-tin plated; silver-colored

1.2.2 Stickers with operating instructions

1.2.2.1 Stickers with operating instructions



Item No.: 210-493

Stickers for operating instructions

1.2.3 Strain relief

1.2.3.1 Strain relief plate



Item No.: 713-127

Strain relief plate; for female connectors; 25 mm wide; 1 part; Pin spacing 3.5 mm; black

1.2.4 Tool

1.2.4.1 Operating tool



Item No.: 210-719

Operating tool; Blade: 2.5 x 0.4 mm; with a partially insulated shaft



Item No.: 210-647

Operating tool; Blade: 2.5 x 0.4 mm; with a partially insulated shaft; multicoloured

Installation Notes

Conductor termination

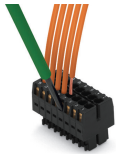

Inserting a conductor via (2.5 x 0.4) mm screwdriver.

Locking system

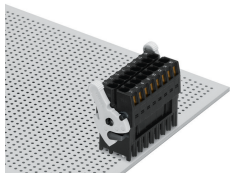

Lever as a lock – when closed, female connector is locked.

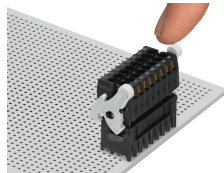

Lever as a disconnection aid – when opened, female connector is disconnected. Rotating the lever lifts the female connector out of the male header.

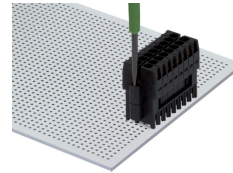

Screw interlock can only be disconnected using a tool.

Coding



Coding a female connector by removing coding finger(s).

Strain relief

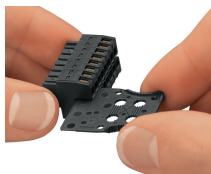

Strain relief plate for field assembly

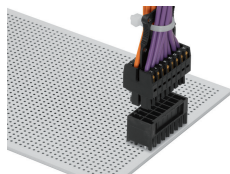

Centered strain relief plate anchors conductors for easy disconnection.