

## Data Sheet | Item Number: 713-1103/037-000

1-conductor female connector, 2-row; CAGE CLAMP®; 1.5 mm<sup>2</sup>; Pin spacing 3.5 mm; 6-pole; 100% protected against mismatching; Levers; black

<https://www.wago.com/713-1103/037-000>

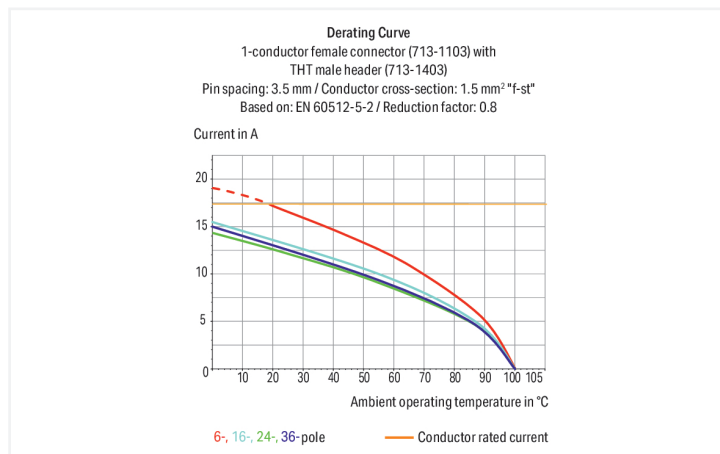

Color: ■ black

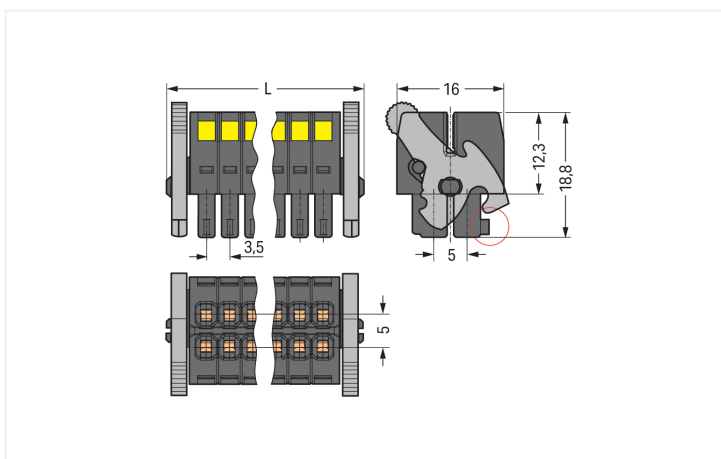

Dimensions in mm

$L = [(pole\ no./2) - 1] \times pin\ spacing + 12.2\ mm$  Coding finger (red circle)

Female connector, 713 Series, operating tool

This female connector (item number 713-1103/037-000) is designed for seamless electrical installations. Conductors can only be connected to this female connector if their strip length is between 6 and 7 mm. This product features one conductor terminal and utilizes CAGE CLAMP®. Our reliable and maintenance-free CAGE CLAMP® connection makes it easy to connect all conductor types without having to prepare the conductor. For example, you don't need to crimp ferrules. The item's dimensions are (19.2 x 16.5 x 22.3) mm (width x height x depth). This female connector is suitable for conductor cross sections ranging from 0.08 mm<sup>2</sup> to 1.5 mm<sup>2</sup>.

The contact surface is coated with tin.

## Notes

## Safety Information

The MCS – MULTI CONNECTION SYSTEM includes connectors without breaking capacity in accordance with DIN EN 61984. When used as intended, these connectors must not be connected/disconnected when live or under load. When used as intended, these connectors must not be connected/disconnected when live or under load. The circuit design should ensure header pins, which can be touched, are not live when unmated.

## Variants:

Other pole numbers  
Gold-plated or partially gold-plated contact surfaces  
Other versions (or variants) can be requested from WAGO Sales or configured at <https://configurator.wago.com/>.

## Electrical data

Ratings per	IEC/EN 60664-1			Approvals per	UL 1059		
	III	III	II		Use group	B	C
Overvoltage category	III	III	II	Use group	B	C	D
Pollution degree	3	2	2	Rated voltage	300 V	50 V	-
Nominal voltage	80 V	160 V	250 V	Rated current	10 A	10 A	-
Rated impulse withstand voltage	2.5 kV	2.5 kV	2.5 kV				
Rated current	10 A	10 A	10 A				

Approvals per	CSA		
Use group	B	C	D
Rated voltage	300 V	-	-
Rated current	10 A	-	-

## Connection Data

Clamping units	6	<b>Connection 1</b>	
Total number of potentials	6	Connection technology	CAGE CLAMP®
Number of connection types	1	Actuation type	Operating tool
Number of levels	2	Actuation direction 1	Operation perpendicular to conductor entry
		Solid conductor	0.08 ... 1.5 mm <sup>2</sup> / 28 ... 16 AWG
		Fine-stranded conductor	0.08 ... 1.5 mm <sup>2</sup> / 28 ... 16 AWG
		Fine-stranded conductor; with insulated ferrule	0.25 ... 1 mm <sup>2</sup>
		Fine-stranded conductor; with uninsulated ferrule	0.25 ... 1 mm <sup>2</sup>
		Strip length	6 ... 7 mm / 0.24 ... 0.28 inches
		Pole number	6
		Conductor entry direction to mating direction	0°

## Physical data

Pin spacing	3.5 mm / 0.138 inches
Width	19.2 mm / 0.756 inches
Height	16.5 mm / 0.65 inches
Depth	22.3 mm / 0.878 inches

### Mechanical data

Variable coding	Yes
Anti-rotation protection	Yes

### Plug-in connection

Contact type (pluggable connector)	Female connector/socket
Connector (connection type)	for conductor
Mismating protection	Yes
Locking of plug-in connection	Locking lever

### Material data

Note (material data)	<a href="#">Information on material specifications can be found here</a>
Color	black
Material group	II
Insulation material (main housing)	Glass fiber-reinforced polyamide (PA66 GF)
Flammability class per UL94	V0
Clamping spring material	Chrome-nickel spring steel (CrNi)
Contact material	Copper alloy
Contact Plating	Tin
Fire load	0.054 MJ
Weight	4.3 g

### Environmental requirements

Limit temperature range	-60 ... +100 °C
Processing temperature	-35 ... +60 °C

### Commercial data

Product Group	3 (Multi Conn. System)
PU (SPU)	50 pcs
Packaging type	Box
Country of origin	PL
GTIN	4045454806149
Customs tariff number	85366990990

### Product Classification

UNSPSC	39121409
eCl@ss 10.0	27-14-11-06
eCl@ss 9.0	27-14-11-06
ETIM 9.0	EC001284
ETIM 10.0	EC001284
ECCN	NO US CLASSIFICATION

**Environmental Product Compliance**

RoHS Compliance Status	Compliant, No Exemption
SCIP notification number (Austria)	be468e7e-1e0e-4854-b01e-46c73f465dd2
SCIP notification number (Belgium)	6471e138-464c-4875-b7bc-4a83baf4f2f2
SCIP notification number (Bulgaria)	1861aaa9-30ac-4565-b17a-0cbde8b6ea16
SCIP notification number (Czech Republic)	54345dbd-9357-47fc-814c-e0bc15d5d1b0
SCIP notification number (Denmark)	eac688f7-af91-491d-a1c3-093e8501ed28
SCIP notification number (Finland)	dc7dc021-1545-49a7-bcd4-09a456338cce
SCIP notification number (France)	c6854407-b5d6-4870-9fec-ed6c1affca43
SCIP notification number (Germany)	41b2abda-5f35-4bf5-8cb7-a5836e5ac703
SCIP notification number (Hungary)	0f72cc45-3a78-4c15-8075-866e02453304
SCIP notification number (Italy)	44c419ae-3ae9-432e-afcc-87416af1dea5
SCIP notification number (Netherlands)	4163280a-9a21-439a-8e5a-fc86b5057c0f
SCIP notification number (Poland)	2cb74eb7-6c5c-47f2-af41-bd38521b9721
SCIP notification number (Romania)	d5e5f413-88bc-422c-b5a9-b9dbf2db5a03
SCIP notification number (Sweden)	22b8be04-78ea-4a7f-be66-466a8ac4c4bb

**Downloads**

**Environmental Product Compliance**

<b>Compliance Search</b>	
Environmental Product Compliance 713-1103/037-000	<a href="#">↓</a>

**Documentation**

<b>Additional Information</b>			
Technical Section	03.04.2019	pdf 2027.26 KB	<a href="#">↓</a>

**CAD/CAE-Data**

<b>CAD data</b>	
2D/3D Models 713-1103/037-000	<a href="#">↓</a>

<b>CAE data</b>	
ZUKEN Portal 713-1103/037-000	<a href="#">↓</a>

**1 Compatible Products**

**1.1 System counterpart**

**1.1.1 Male connector/plug**



**Item No.: 713-1423/116-000/997-405**  
THR male header, 2-row; 0.8 x 0.8 mm solder pin; angled; 100% protected against mismatching; Levers; in tape-and-reel packaging; Pin spacing 3.5 mm; 6-pole; black



**Item No.: 713-1423/116-000**  
THR male header, 2-row; 0.8 x 0.8 mm solder pin; angled; 100% protected against mismatching; Levers; Pin spacing 3.5 mm; 6-pole; black



**Item No.: 713-1403/116-000/997-405**  
THR male header, 2-row; 0.8 x 0.8 mm solder pin; straight; 100% protected against mismatching; Levers; in tape-and-reel packaging; Pin spacing 3.5 mm; 6-pole; black



**Item No.: 713-1403/116-000**  
THR male header, 2-row; 0.8 x 0.8 mm solder pin; straight; 100% protected against mismatching; Levers; Pin spacing 3.5 mm; 6-pole; black

### 1.1.1 Male connector/plug



**Item No.: 713-1423/037-000**

THT male header, 2-row; 0.8 x 0.8 mm solder pin; angled; 100% protected against mismatching; Levers; Pin spacing 3.5 mm; 6-pole; black

**Item No.: 713-1403/037-000**

THT male header, 2-row; 0.8 x 0.8 mm solder pin; straight; 100% protected against mismatching; Levers; Pin spacing 3.5 mm; 6-pole; black

**Item No.: 713-1463/037-000**

THT male header, 2-row; 0.8 x 0.8 mm solder pin; straight; 100% protected against mismatching; with orientation nose; Levers; Pin spacing 3.5 mm; 6-pole; black

### 1.2 Optional Accessories

#### 1.2.1 Ferrule

##### 1.2.1.1 Ferrule



**Item No.: 216-321**

Ferrule; Sleeve for 0.25 mm<sup>2</sup> / AWG 24; insulated; electro-tin plated; yellow



**Item No.: 216-131**

Ferrule; Sleeve for 0.25 mm<sup>2</sup> / AWG 24; uninsulated; electro-tin plated; silver-colored



**Item No.: 216-322**

Ferrule; Sleeve for 0.34 mm<sup>2</sup> / 22 AWG; insulated; electro-tin plated; light turquoise



**Item No.: 216-132**

Ferrule; Sleeve for 0.34 mm<sup>2</sup> / 22 AWG; uninsulated; electro-tin plated



**Item No.: 216-221**

Ferrule; Sleeve for 0.5 mm<sup>2</sup> / 20 AWG; insulated; electro-tin plated; white



**Item No.: 216-121**

Ferrule; Sleeve for 0.5 mm<sup>2</sup> / AWG 22; uninsulated; electro-tin plated; silver-colored



**Item No.: 216-222**

Ferrule; Sleeve for 0.75 mm<sup>2</sup> / 18 AWG; insulated; electro-tin plated; gray



**Item No.: 216-122**

Ferrule; Sleeve for 0.75 mm<sup>2</sup> / 18 AWG; uninsulated; electro-tin plated; silver-colored



**Item No.: 216-223**

Ferrule; Sleeve for 1 mm<sup>2</sup> / AWG 18; insulated; electro-tin plated; red



**Item No.: 216-123**

Ferrule; Sleeve for 1 mm<sup>2</sup> / AWG 18; uninsulated; electro-tin plated; silver-colored

### 1.2.2 Stickers with operating instructions

#### 1.2.2.1 Stickers with operating instructions



**Item No.: 210-493**

Stickers for operating instructions

### 1.2.3 Strain relief

#### 1.2.3.1 Strain relief plate



**Item No.: 713-126**

Strain relief plate; for female connectors; 11 mm wide; 1 part; Pin spacing 3.5 mm; black

## 1.2.4 Tool

### 1.2.4.1 Operating tool



**Item No.: 210-719**

Operating tool; Blade: 2.5 x 0.4 mm; with a partially insulated shaft

**Item No.: 210-647**

Operating tool; Blade: 2.5 x 0.4 mm; with a partially insulated shaft; multicoloured

## Installation Notes

### Conductor termination

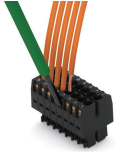

Inserting a conductor via (2.5 x 0.4) mm screwdriver.

### Locking system

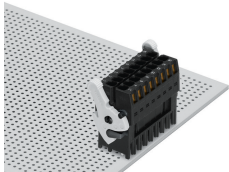

Lever as a lock – when closed, female connector is locked.

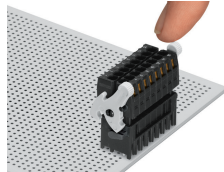

Lever as a disconnection aid – when opened, female connector is disconnected. Rotating the lever lifts the female connector out of the male header.

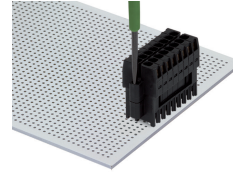

Screw interlock can only be disconnected using a tool.

### Coding



Coding a female connector by removing coding finger(s).

### Strain relief

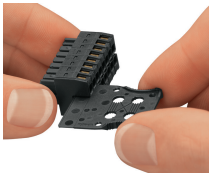

Strain relief plate for field assembly

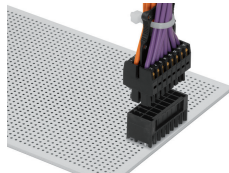

Centered strain relief plate anchors conductors for easy disconnection.