

## Data Sheet | Item Number: 294-5153

Lighting connector; push-button, external; with direct ground contact; 3-pole; Lighting side: for solid conductors; Inst. side: for all conductor types; max. 2.5 mm<sup>2</sup>; Surrounding air temperature: max 85°C (T85); white

<https://www.wago.com/294-5153>



Color: ■ white

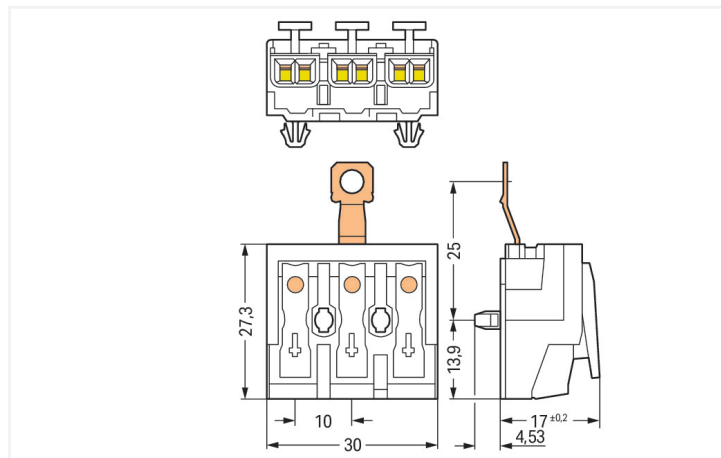

Dimensions in mm

Field-wiring terminal block, 294 Series, push-button

Our field-wiring terminal block (item number 294-5153) is designed for seamless electrical installations. Conductors should only be connected to this field-wiring terminal block if their strip length is between 8 and 9 mm. Featuring four conductor terminals along with Push-in CAGE CLAMP® as well as PUSH WIRE®, this product outperforms the competition. Our Push-in CAGE CLAMP® is a universal, maintenance-free connection solution for all conductor types, offering a key advantage: It allows direct insertion of both solid and fine-stranded conductors with ferrules without needing tools. No preparation is required; for example, crimping the conductor's ferrule is not necessary. Our PUSH WIRE® connection uses the stiffness of the conductor to overcome the clamping spring's contact force, allowing faster and easier conductor clamping. Dimensions: (30 x 21.53 x 27.3) mm (width x height x depth). This field-wiring terminal block is suitable for conductor cross sections ranging from 0.5 mm<sup>2</sup> to 2.5 mm<sup>2</sup> on one side and for conductor cross sections ranging from 0.5 mm<sup>2</sup> to 2.5 mm<sup>2</sup> on the other side as well as conductor cross sections from 0.5 mm<sup>2</sup> to 2.5 mm<sup>2</sup> and from 0.5 mm<sup>2</sup> to 0.75 mm<sup>2</sup> depending on the conductor type.

The contact surface is coated with tin.

### Electrical data

Ratings per	IEC/EN 60998-1		
Overvoltage category	III	III	II
Pollution degree	3	2	2
Nominal voltage	-	-	500 V
Rated impulse withstand voltage	-	-	4 kV
Rated current	-	-	24 A

Ratings per IEC/EN – Notes	
Ratings (note)	Connection points

Ratings per	IEC/EN 60998-2-2		
Overvoltage category	III	III	II
Pollution degree	3	2	2
Nominal voltage	-	-	500 V
Rated impulse withstand voltage	-	-	4 kV
Rated current	-	-	24 A

General information	
Wiring direction	Side-entry wiring

## Connection Data

Clamping units	15
Total number of potentials	3
Number of connection types	4
PE function	Direct PE contact

### Connection 1

Connection type	External 1
Connection technology	Push-in CAGE CLAMP®
Number of connection points	2
Actuation type	Push-button
Connectable conductor materials	Copper
Solid conductor	0.5 ... 2.5 mm <sup>2</sup> / 18 ... 12 AWG
Solid conductor; push-in termination	0.5 ... 2.5 mm <sup>2</sup> / 18 ... 12 AWG
Stranded conductor	0.5 ... 2.5 mm <sup>2</sup> / 18 ... 14 AWG
Fine-stranded conductor	0.5 ... 2.5 mm <sup>2</sup> / 18 ... 14 AWG
Fine-stranded conductor; with insulated ferrule	0.5 ... 1.5 mm <sup>2</sup> / 18 ... 16 AWG
Fine-stranded conductor; with uninsulated ferrule	0.5 ... 1.5 mm <sup>2</sup> / 18 ... 16 AWG
Fine-stranded conductor; with ferrule; push-in termination	0.5 mm <sup>2</sup> / 18 AWG
Strip length	8 ... 9 mm / 0.31 ... 0.35 inches
Pole number	3

### Connection 2

Connection type	Internal 2
Connection technology	PUSH WIRE®
Number of connection points	1
Actuation type	Push-in
Solid conductor	0.5 ... 2.5 mm <sup>2</sup> / 18 ... 14 AWG
Fine-stranded conductor; with insulated ferrule	0.5 ... 1 mm <sup>2</sup> / 18 ... 16 AWG
Fine-stranded conductor; with uninsulated ferrule	0.5 ... 1.5 mm <sup>2</sup> / 18 ... 14 AWG
Strip length	8 ... 9 mm / 0.31 ... 0.35 inches

### Connection 3

Connection type	Internal 3
Connection technology	PUSH WIRE®
Number of connection points	1
Actuation type	Push-in
Solid conductor	0.5 ... 1.5 mm <sup>2</sup> / 18 ... 16 AWG
Fine-stranded conductor; with insulated ferrule	0.5 ... 0.75 mm <sup>2</sup> / 18 AWG
Fine-stranded conductor; with uninsulated ferrule	0.5 ... 1 mm <sup>2</sup> / 18 AWG
Strip length	8 ... 9 mm / 0.31 ... 0.35 inches

### Connection 4

Connection type	Internal 4
Connection technology	PUSH WIRE®
Number of connection points	1
Actuation type	Push-in
Solid conductor	0.5 ... 0.75 mm <sup>2</sup> / 18 AWG
Strip length	8 ... 9 mm / 0.31 ... 0.35 inches

## Physical data

Pin spacing	10 mm / 0.394 inches
Width	30 mm / 1.181 inches
Height	21.53 mm / 0.848 inches
Height from the surface	17 mm / 0.669 inches
Depth	27.3 mm / 1.075 inches

### Mechanical data

Marking	1-⊕-N
Mounting type	Snap-in foot

### Material data

Note (material data)	<a href="#">Information on material specifications can be found here</a>
Color	white
Material group	IIIa
Insulation material (main housing)	Polycarbonate (PC)
Flammability class per UL94	V0
Clamping spring material	Chrome-nickel spring steel (CrNi)
Contact material	Electrolytic copper (E <sub>Cu</sub> )
Contact Plating	Tin
Fire load	0.14 MJ
Halogen-free	Yes
Weight	9.4 g

### Environmental requirements

Temperature stability	120 °C
T marking	T85

### Commercial data

Product Group	8 (Misc. Chassis Mount Blocks)
PU (SPU)	500 pcs
Packaging type	Foil
Country of origin	CH
GTIN	4050821098362
Customs tariff number	85369010000

### Product Classification

UNSPSC	39121409
eCl@ss 10.0	27-14-11-06
eCl@ss 9.0	27-14-11-06
ETIM 9.0	EC001284
ETIM 10.0	EC001284
ECCN	NO US CLASSIFICATION

### Environmental Product Compliance

RoHS Compliance Status	Compliant, No Exemption
SCIP notification number (Austria)	6b43a56f-a13a-4d41-903c-14c7c3115576
SCIP notification number (Belgium)	498ce35d-9c0a-4f6a-90e5-77d7385ff8b2
SCIP notification number (Bulgaria)	f37d74c1-11ff-4585-b414-0fcd8a465c1d
SCIP notification number (Czech Republic)	b45fe447-96b7-4c3c-8886-1c1d585862d5
SCIP notification number (Denmark)	abc4d7c3-f9c9-43a3-8a9e-ea6fd08c0fb3
SCIP notification number (Finland)	0615fc1e-efd1-4057-914a-af80171fda7f
SCIP notification number (France)	32f056e9-64c0-4714-82e7-e036f9351a4b
SCIP notification number (Germany)	46bd3989-fa41-4bfd-8ebb-0b5f88da7b91
SCIP notification number (Hungary)	132a3fa9-c1c7-4cc3-a0f2-96a75085f169
SCIP notification number (Italy)	0c840d7c-a6fa-49c5-b975-fc1743a9a796
SCIP notification number (Netherlands)	2b8504e4-35fc-4373-b350-3864e73acde5
SCIP notification number (Poland)	20391ef7-7a8b-4d18-bcf7-69297b1870ea
SCIP notification number (Romania)	f3afe239-8e0c-49f9-81b9-9d5fc04da7be

**Environmental Product Compliance**

SCIP notification number (Sweden)	6f6b5e3f-b011-4fa6-a204-4182855f9b35
-----------------------------------	--------------------------------------

**Approvals / Certificates**

**General approvals**



Approval	Standard	Certificate Name
ENEC 05 DEKRA Certification B.V.	EN 60998	2128791.01

**Declarations of conformity and manufacturer's declarations**

Approval	Standard	Certificate Name
EU-Declaration of Conformity WAGO GmbH & Co. KG	-	-
UK-Declaration of Conformity WAGO GmbH & Co. KG	-	-

**Downloads**

**Environmental Product Compliance**

Compliance Search
Environmental Product Compliance 294-5153 <a href="#">↓</a>

**Documentation**

Bid Text			
294-5153	13.06.2017	doc 28.00 KB	<a href="#">↓</a>
294-5153	19.02.2019	xml 5.58 KB	<a href="#">↓</a>

**CAD/CAE-Data**

CAD data
2D/3D Models 294-5153 <a href="#">↓</a>

CAE data
WSCAD Universe 294-5153 <a href="#">↓</a>
ZUKEN Portal 294-5153 <a href="#">↓</a>

## 1 Compatible Products

### 1.1 Optional Accessories

#### 1.1.1 Strain relief

##### 1.1.1.1 Strain relief



**Item No.: 294-370**

Strain relief; for 294 Series; with snap-in mounting feet; white

**Item No.: 294-375**

Strain relief; for 294 Series; without snap-in mounting feet; white

##### 1.1.1.2 Strain relief plate



**Item No.: 294-364**

Strain relief plate; for 294 Series; for multi-core cables; 3- to 5-pole; with secured clamp; white

**Item No.: 294-384**

Strain relief plate; for 294 Series; for single strands; 3- to 5-pole; with secured clamp; white

### 1.1.2 Tool

#### 1.1.2.2 Operating tool



**Item No.: 206-294**

Disconnection tool; green

## Installation Notes

### Installation

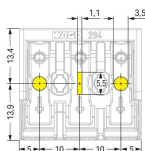

3-pole – with direct ground contact

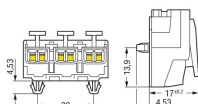

Snap-in foot

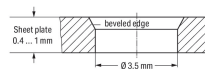

Drilled hole for snap-in mounting foot

## Conductor termination

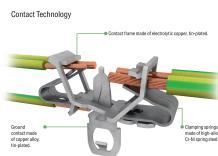

EUROPE	
1 x 0.5 ... 2.5 mm <sup>2</sup> "s"	
1 x 0.5 ... 1.5 mm <sup>2</sup> "s"	
1 x 0.5 ... 0.75 mm <sup>2</sup> "s"	
AMERICA	
1 x AWG 18 ... 14 "s"	
1 x AWG 18 ... 16 "s"	
1 x AWG 18 "s"	
JAPAN	
1 x 0.8 ... 1.6 mm diam. "s"	
1 x 0.8 ... 1 mm diam. "s"	
1 x 0.8 mm diam. "s"	

EUROPE	
2 x 0.5 ... 2.5 mm <sup>2</sup> "s, f-str"	
AMERICA	
2 x AWG 18 ... 12 "s"	
2 x AWG 18 ... 14 "s, f-str"	
JAPAN	
2 x 0.8 ... 2 mm diam. "s"	
2 x 0.5 ... 2 mm <sup>2</sup> "str, f-str"	

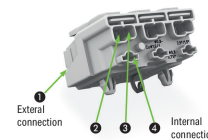

**Internal connection:**  
PUSH WIRE® for internal wiring with solid conductors

**External connection:**  
Push-in CAGE CLAMP® for field-wiring with all conductor types

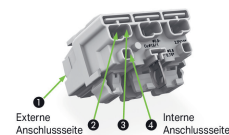

Terminating five conductors per pole – solid and fine-stranded.

