

Data Sheet | Item Number: 294-5123

Lighting connector; push-button, external; with direct ground contact; 3-pole; Lighting side: for solid conductors; Inst. side: for all conductor types; max. 2.5 mm²; Surrounding air temperature: max 85°C (T85); white

<https://www.wago.com/294-5123>



Color: ■ white

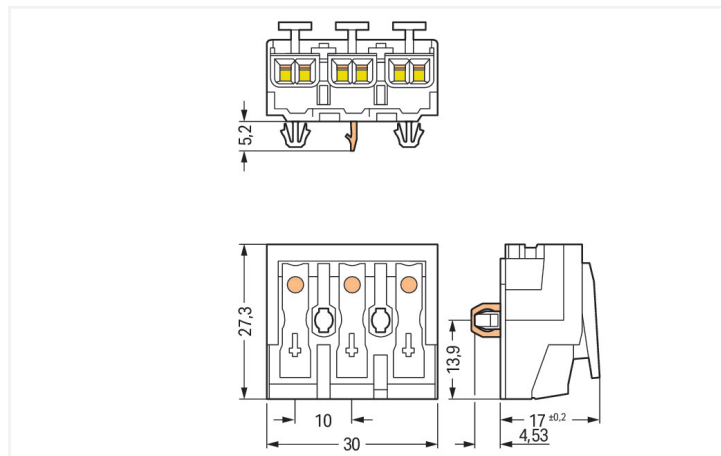

Dimensions in mm

Field-wiring terminal block, 294 Series, white

This field-wiring terminal block (item number 294-5123) is designed for quick and simple connections. Strip lengths must be between 8 and 9 mm when connecting conductors to this field-wiring terminal block. This product features four conductor terminals and utilizes Push-in CAGE CLAMP® as well as PUSH WIRE®. Our Push-in CAGE CLAMP® is a universal, maintenance-free connection solution for all conductor types, featuring a winning design: It allows direct insertion of both solid and fine-stranded conductors with ferrules without needing tools. No preparation is required; for example, crimping the conductor's ferrule is not necessary. Our PUSH WIRE® connection is the quick and simple method for connecting solid conductors. The item's dimensions are (30 x 21.53 x 27.3) mm (width x height x depth). Depending on the conductor type, this field-wiring terminal block is ideal for conductor cross sections ranging from 0.5 mm² to 2.5 mm² on one side and for conductor cross sections from 0.5 mm² to 2.5 mm² on the other side as well as conductor cross sections from 0.5 mm² to 1.5 mm² and from 0.5 mm² to 0.75 mm².

The contact surface is coated with tin.

Electrical data

Ratings per	IEC/EN 60998-1		
Overvoltage category	III	III	II
Pollution degree	3	2	2
Nominal voltage	-	-	500 V
Rated impulse withstand voltage	-	-	4 kV
Rated current	-	-	24 A

Ratings per IEC/EN – Notes	
Ratings (note)	Connection points

Ratings per	IEC/EN 60998-2-2		
Overvoltage category	III	III	II
Pollution degree	3	2	2
Nominal voltage	-	-	500 V
Rated impulse withstand voltage	-	-	4 kV
Rated current	-	-	24 A

General information	
Wiring direction	Side-entry wiring

Connection Data

Clamping units	15
Total number of potentials	3
Number of connection types	4
PE function	Direct PE contact

Connection 1

Connection type	External 1
Connection technology	Push-in CAGE CLAMP®
Number of connection points	2
Actuation type	Push-button
Connectable conductor materials	Copper
Solid conductor	0.5 ... 2.5 mm ² / 18 ... 12 AWG
Solid conductor; push-in termination	0.5 ... 2.5 mm ² / 18 ... 12 AWG
Stranded conductor	0.5 ... 2.5 mm ² / 18 ... 14 AWG
Fine-stranded conductor	0.5 ... 2.5 mm ² / 18 ... 14 AWG
Fine-stranded conductor; with insulated ferrule	0.5 ... 1.5 mm ² / 18 ... 16 AWG
Fine-stranded conductor; with uninsulated ferrule	0.5 ... 1.5 mm ² / 18 ... 16 AWG
Fine-stranded conductor; with ferrule; push-in termination	0.5 mm ² / 18 AWG
Strip length	8 ... 9 mm / 0.31 ... 0.35 inches
Pole number	3

Connection 2

Connection type	Internal 2
Connection technology	PUSH WIRE®
Number of connection points	1
Actuation type	Push-in
Solid conductor	0.5 ... 2.5 mm ² / 18 ... 14 AWG
Fine-stranded conductor; with insulated ferrule	0.5 ... 1 mm ² / 18 ... 16 AWG
Fine-stranded conductor; with uninsulated ferrule	0.5 ... 1.5 mm ² / 18 ... 14 AWG
Strip length	8 ... 9 mm / 0.31 ... 0.35 inches

Connection 3

Connection type	Internal 3
Connection technology	PUSH WIRE®
Number of connection points	1
Actuation type	Push-in
Solid conductor	0.5 ... 1.5 mm ² / 18 ... 16 AWG
Fine-stranded conductor; with insulated ferrule	0.5 ... 0.75 mm ² / 18 AWG
Fine-stranded conductor; with uninsulated ferrule	0.5 ... 1 mm ² / 18 AWG
Strip length	8 ... 9 mm / 0.31 ... 0.35 inches

Connection 4

Connection type	Internal 4
Connection technology	PUSH WIRE®
Number of connection points	1
Actuation type	Push-in
Solid conductor	0.5 ... 0.75 mm ² / 18 AWG
Strip length	8 ... 9 mm / 0.31 ... 0.35 inches

Physical data

Pin spacing	10 mm / 0.394 inches
Width	30 mm / 1.181 inches
Height	21.53 mm / 0.848 inches
Height from the surface	17 mm / 0.669 inches
Depth	27.3 mm / 1.075 inches

Mechanical data

Marking	N ⁻ ⊖-L ⁻
Mounting type	Snap-in foot

Material data

Note (material data)	Information on material specifications can be found here
Color	white
Material group	IIIa
Insulation material (main housing)	Polycarbonate (PC)
Flammability class per UL94	V0
Clamping spring material	Chrome-nickel spring steel (CrNi)
Contact material	Electrolytic copper (E _{Cu})
Contact Plating	Tin
Fire load	0.14 MJ
Halogen-free	Yes
Weight	9.4 g

Environmental requirements

Temperature stability	120 °C
T marking	T85

Commercial data

Product Group	8 (Misc. Chassis Mount Blocks)
PU (SPU)	500 pcs
Packaging type	Foil
Country of origin	CH
GTIN	4050821098348
Customs tariff number	85369010000

Product Classification

UNSPSC	39121409
eCl@ss 10.0	27-14-11-06
eCl@ss 9.0	27-14-11-06
ETIM 9.0	EC001284
ETIM 10.0	EC001284
ECCN	NO US CLASSIFICATION

Environmental Product Compliance

RoHS Compliance Status	Compliant, No Exemption
SCIP notification number (Austria)	9a889a09-71d9-4988-8bf6-7d5f90a1c551
SCIP notification number (Belgium)	4ee97b4f-601f-441b-a050-91b384407d49
SCIP notification number (Bulgaria)	2664e496-655d-4927-a074-61d955183c29
SCIP notification number (Czech Republic)	e916031c-8165-41f9-8428-7570f29d6850
SCIP notification number (Denmark)	2222594a-9dca-4730-bd41-bc0f342f6465
SCIP notification number (Finland)	a1160814-6f09-4362-80b7-2fdb146ff2d9
SCIP notification number (France)	f5b471b2-ec87-42a4-926b-4b0c201ec6b4
SCIP notification number (Germany)	517b8b6f-9f23-4dfc-b86e-29de43d136a0
SCIP notification number (Hungary)	898a1a0a-5692-484d-9b45-be2112cc6297
SCIP notification number (Italy)	d4ee37f4-5520-423b-8a93-379bf2bd8b8b
SCIP notification number (Netherlands)	4c538805-4bf4-4e3a-9b1f-91803db9497b
SCIP notification number (Poland)	6bb9efe2-eb01-4694-a81e-77ee1bab45ec
SCIP notification number (Romania)	7c1e0b34-312d-4729-99c8-9df3b44f7527

Environmental Product Compliance

SCIP notification number (Sweden)	16d3473a-b198-49bf-be63-524a4e9bf7ba
-----------------------------------	--------------------------------------

Approvals / Certificates

General approvals **Declarations of conformity and manufacturer's declarations**



Approval	Standard	Certificate Name
ENEC 05 DEKRA Certification B.V.	EN 60998	2128791.01

Approval	Standard	Certificate Name
EU-Declaration of Conformity WAGO GmbH & Co. KG	-	-
UK-Declaration of Conformity WAGO GmbH & Co. KG	-	-

Downloads

Environmental Product Compliance

Compliance Search
Environmental Product Compliance 294-5123 ↓

Documentation

Bid Text			
294-5123	13.06.2017	doc 28.00 KB	↓
294-5123	19.02.2019	xml 5.59 KB	↓

CAD/CAE-Data

CAD data
2D/3D Models 294-5123 ↓

CAE data
WSCAD Universe 294-5123 ↓
ZUKEN Portal 294-5123 ↓

1 Compatible Products

1.1 Optional Accessories

1.1.1 Strain relief

1.1.1.1 Strain relief



Item No.: 294-370

Strain relief; for 294 Series; with snap-in mounting feet; white

Item No.: 294-375

Strain relief; for 294 Series; without snap-in mounting feet; white

1.1.1.2 Strain relief plate



Item No.: 294-364

Strain relief plate; for 294 Series; for multi-core cables; 3- to 5-pole; with secured clamp; white

Item No.: 294-384

Strain relief plate; for 294 Series; for single strands; 3- to 5-pole; with secured clamp; white

1.1.2 Tool

1.1.2.2 Operating tool



Item No.: 206-294

Disconnection tool; green

Installation Notes

Installation

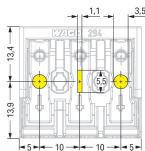

3-pole – with direct ground contact

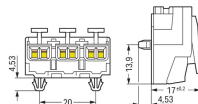

Snap-in foot

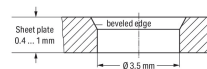

Drilled hole for snap-in mounting foot

Conductor termination

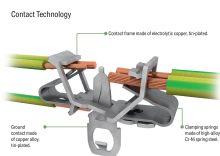

EUROPE	
1 x 0.5 ... 2.5 mm ² "s"	
1 x 0.5 ... 1.5 mm ² "s"	
1 x 0.5 ... 0.75 mm ² "s"	
AMERICA	
1 x AWG 18 ... 14 "s"	
1 x AWG 18 ... 16 "s"	
1 x AWG 18 "s"	
JAPAN	
1 x 0.8 ... 1.6 mm diam. "s"	
1 x 0.8 ... 1 mm diam. "s"	
1 x 0.8 mm diam. "s"	

EUROPE	
2 x 0.5 ... 2.5 mm ² "s, str, f-str"	
AMERICA	
2 x AWG 18 ... 12 "s"	
2 x AWG 18 ... 14 "s, f-str"	
JAPAN	
2 x 0.8 ... 2 mm diam. "s"	
2 x 0.5 ... 2 mm ² str, f-str"	

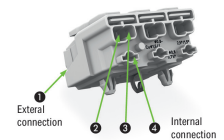

Internal connection:
PUSH WIRE® for internal wiring with solid conductors

External connection:
Push-in CAGE CLAMP® for field-wiring with all conductor types

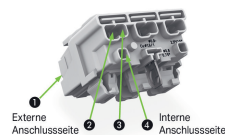

Terminating five conductors per pole – solid and fine-stranded.

