

kHz Range Crystal unit

- Package size (1.6 mm × 1.0 mm × 0.5 mm)
- Fundamental mode
- Reference weight Typ.2.6 mg

[1] Product Number / Product Name / Marking

(1-1) Product Number / Ordering Code

X1A0001910003xx

Last 2 digits code(xx) defines Quantity.

The standard is "18", 5 000 pcs/Reel.

(1-2) Product Name / Model Name

FC1610BN 32.768000 kHz 7.0 +20.0-20.0

[2] Absolute maximum ratings

Parameter	Symbol	Specifications			Unit	Conditions
		Min.	Typ.	Max.		
Storage temperature	T_stg	-55	-	+125	°C	Storage as single product
Maximum drive level	GL	-	-	0.5	μW	

[3] Specifications(characteristics)

Parameter	Symbol	Specifications			Unit	Conditions
		Min.	Typ.	Max.		
Nominal frequency	f_nom	-	32.768000	-	kHz	
Operating temperature	T_use	-40	-	+105	°C	
Level of drive	DL	-	0.1	0.5	μW	
Frequency tolerance	f_tol	-20	-	+20	x 10 ⁻⁶	+25 °C DL = 0.1 μW
Turnover temperature	Ti	+20	+25	+30	°C	
Parabolic coefficient	B	-	-	-0.04	x 10 ⁻⁶ /°C ²	
Load capacitance	CL	-	7.0	-	pF	
Motional resistance (ESR)	R1	-	45	-	kΩ	+25 °C
		-	-	60		-40 °C to +85 °C
		-	-	70		-40 °C to +105 °C
Motional capacitance	C1	-	7.8	-	fF	
Shunt capacitance	C0	-	1.5	-	pF	
Motional inductance	L1	-	3.0	-	kH	
Frequency aging	f_age	-3	-	+3	x10 ⁻⁶ /year	+25 °C, First year

[For other general specifications, please refer to the attached Full Data Sheet below]

Low ESR, 1.6 x 1.0 mm size

32.768 kHz Crystal unit: FC1610BN

Features

- Package size: 1.6 x 1.0 mm, t = 0.5 mm Max.
- Nominal frequency range: 32.768 kHz
- Frequency tolerance: $\pm 20 \times 10^{-6}$ (+25 °C)
- Operating temperature: -40 °C to +105 °C
- ESR:
 - 45 k Ω Typ. (+25 °C)
 - 60 k Ω Max. (-40 °C to +85 °C)
 - 70 k Ω Max. (-40 °C to +105 °C)

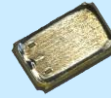

FC1610BN
(1.6 x 1.0 mm, t = 0.5 mm Max.)

Applications

- Wearable products
- MCUs for sub-clock
- Wireless modules for sub-clock
- FA equipment

Description

FC1610BN is a small size (1.6 mm x 1.0 mm) and low ESR (70 k Ω) 32.768 kHz crystal unit. Ideal for IoT (BLE, LPWA, etc.) sleep clocks that require small size and low power, clocks for wearable devices, sub clocks for microcomputers, etc. The operating temperature range is supported up to +105°C.

Epson is a leading supplier of kHz-band crystal units and offers a lineup of oscillators with built-in oscillator circuit ICs and real-time clock modules with built-in real-time clock ICs, in addition to crystal units. Epson is committed to providing the lowest power solution for our customers.

Outline Drawing and Terminal Assignment

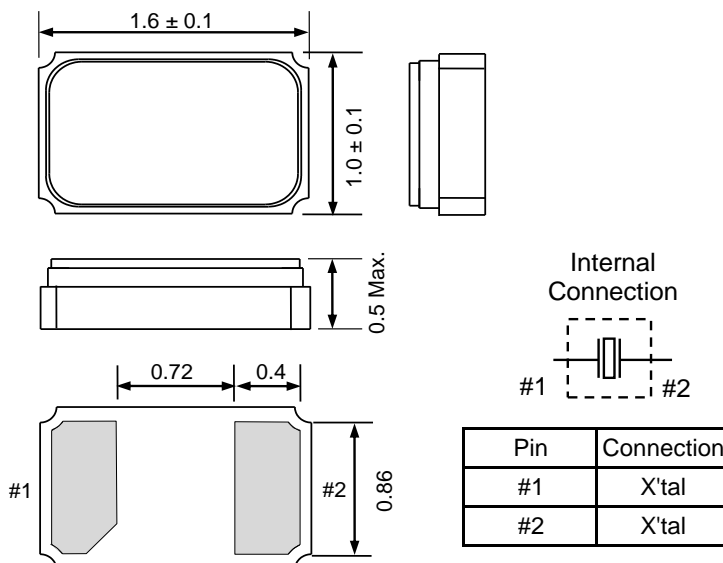

[1] Product Number / Product Name

(1-1) Product Number

X1A000191xxx18 (Please contact Epson for details)

(1-2) Product Name (Standard Form)

FC1610BN 32.768000kHz 12.5 +20.0-20.0

a b c d

a: Model b: Frequency c: Load capacitance (pF) d: Frequency tolerance ($\times 10^{-6}$, +25 °C)

[2] Absolute Maximum Ratings

Item	Symbol	Rating value			Unit	Note
		Min.	Typ.	Max.		
Storage temperature range	T_stg	-55	-	+125	°C	
Maximum level of drive	GL	-	-	0.5	μ W	

[3] Operating Conditions

Item	Symbol	Rating value			Unit	Note
		Min.	Typ.	Max.		
Operating temperature range	T_use	-40	-	+105	°C	
Level of drive	DL	0.01	0.1	0.5	μ W	
Load capacitance	CL	7.0, 9.0, 12.5			pF	Please contact us for other CL values

[4] Static Characteristics

Item	Symbol	Specifications	Unit	Condition / Remarks
Nominal frequency range	f_nom	32.768	kHz	
Frequency tolerance	f_tol	± 20	$\times 10^{-6}$	T_use = +25 °C \pm 3 °C DL = 0.1 μ W Does not include frequency aging
Turnover temperature	Ti	+25 \pm 5	°C	
Parabolic coefficient	B	-0.04 Max.	$\times 10^{-6} / ^\circ\text{C}^2$	
Motional resistance(ESR)	R1	45 Typ. (+25 °C)	k Ω	Measuring instrument: Keysight 4294A DL = 0.5 μ W
		60 Max. (-40 °C to +85 °C)		
		70 Max. (-40 °C to +105 °C)		
Motional capacitance	C1	7.8 Typ.	fF	
Shunt capacitance	C0	1.5 Typ.	pF	
Isolation resistance	IR	200 Min.	M Ω	
Frequency aging	f_age	± 3	$\times 10^{-6}$	T_use = +25 °C \pm 3 °C, First year, DL = 0.1 μ W

[5] Frequency vs. Temperature Characteristics

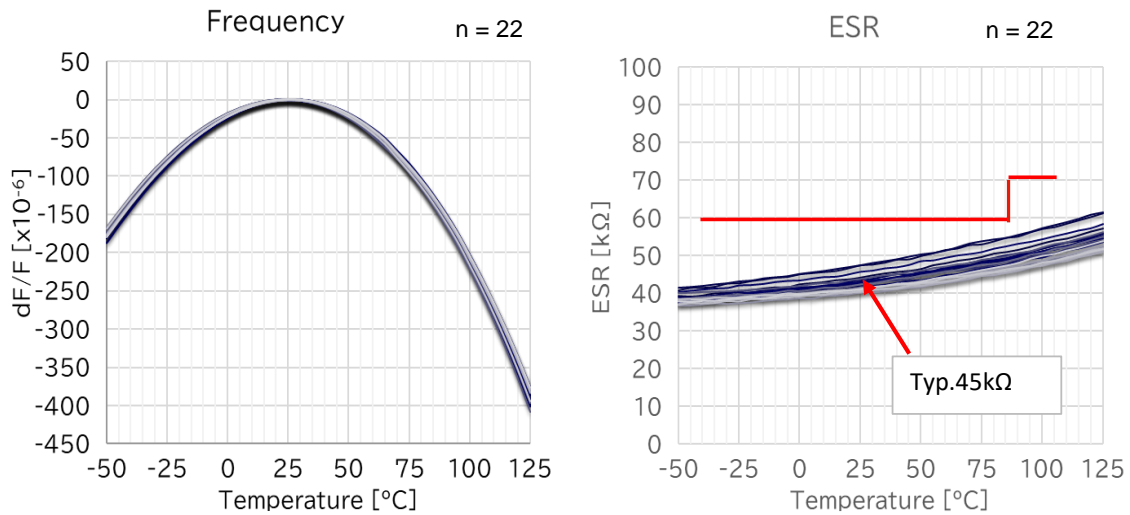

[6] Marking Description

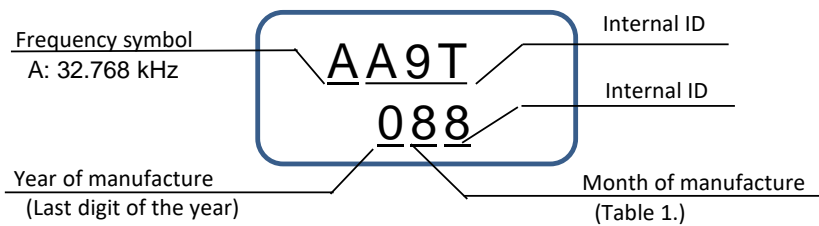
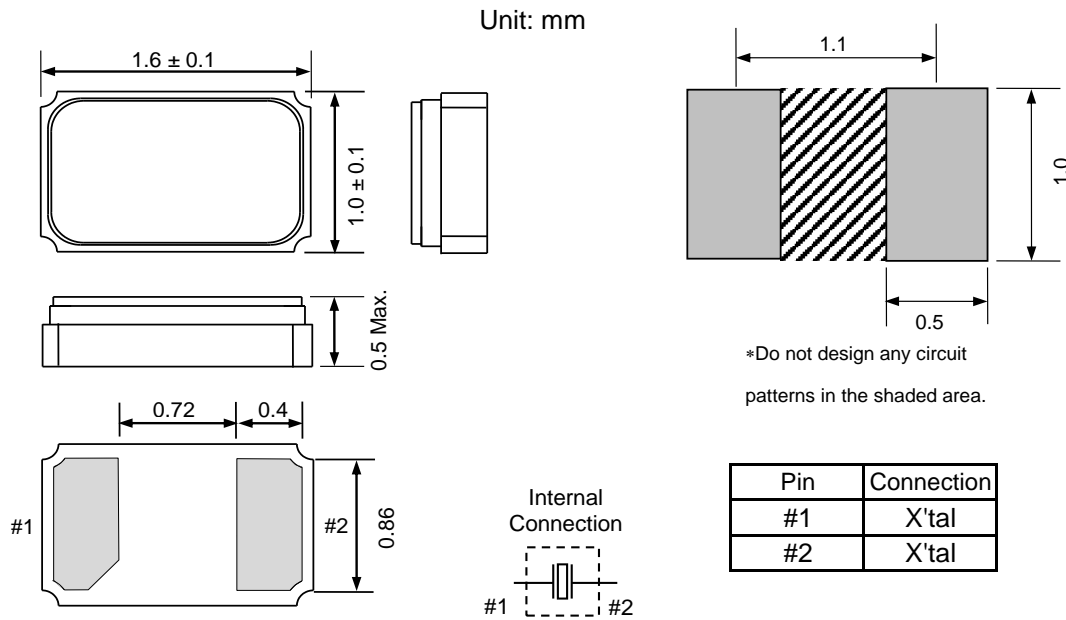

Table 1. Month of manufacture

Month	Jan	Feb	Mar	Apr	May	Jun	Jul	Aug	Sep	Oct	Nov	Dec
Code	1	2	3	4	5	6	7	8	9	X	Y	Z

[7] Outline Drawing and Recommended Footprint



Reference weight: Typ.2.6 mg

Terminal coating: Au plating

[8] Moisture Sensitivity Level

Parameter	Specification	Conditions
MSL	LEVEL1	IPC/JEDEC J-STD-020D.1

[9] Reflow Profile (IPC/JEDEC J-STD-020D.1)

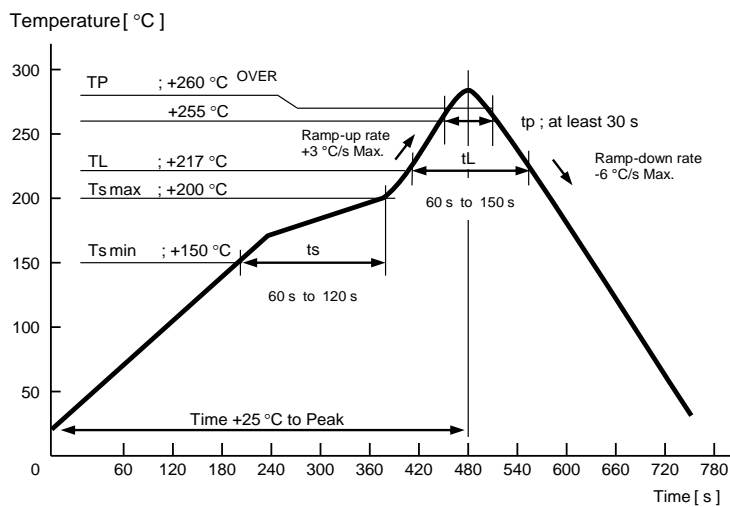

[10] Packing Information

(1) Packing Quantity

The last two digits of the Product Number (X1A000191xxxx18) are a code that defines the packing quantity
The standard is "18" for a 5 000 pcs/Reel.

(2) Taping Specification

Compliant to EIA-481, IEC 60286

(2-1) Tape Dimensions

Carrier Tape Material : PS (Polystyrene)

Top Tape Material : PET (Polyethylene Terephthalate) +PE (Polyethylene)

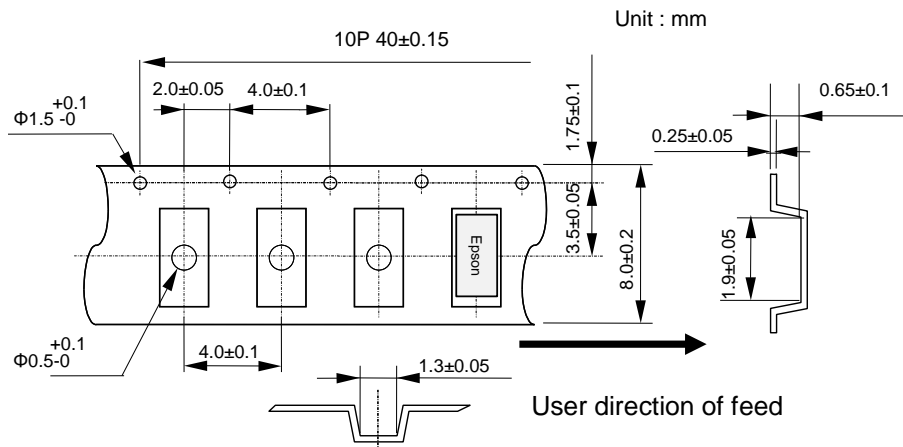

(2-2) Reel Dimensions

Center Material : PS (Polystyrene)

Reel Material : PS (Polystyrene)

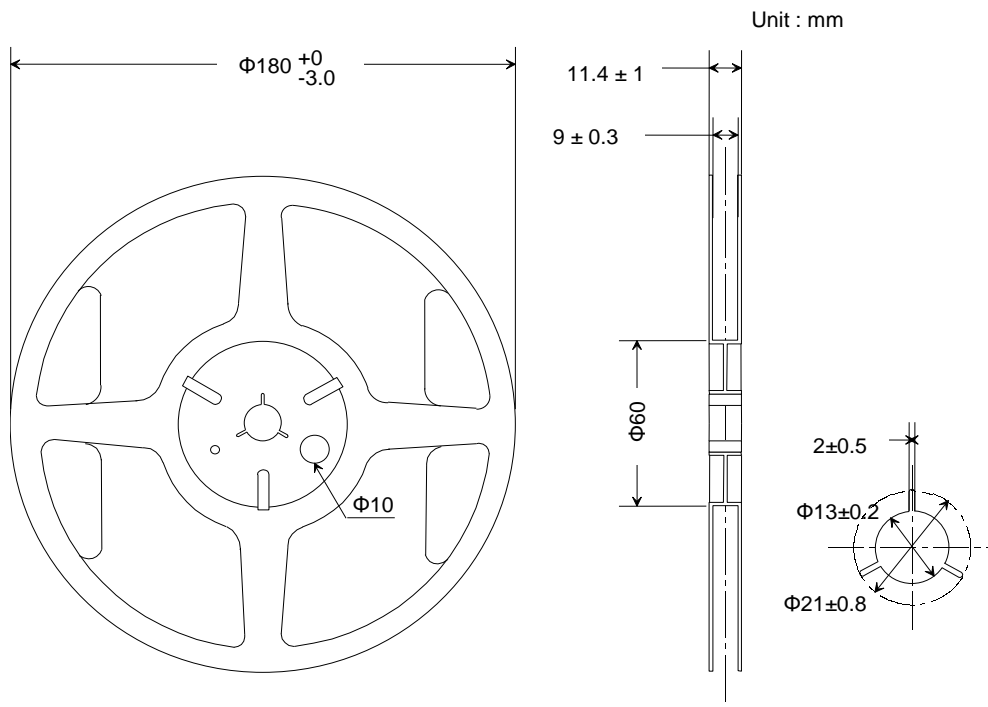

[11] Handling Precautions

Please review the "Handling Precautions" on our website for proper handling and behavior to ensure the performance of your equipment/product.

(<https://www5.epsondevice.com/en/information/#precaution>) In addition to the "Handling Precautions" on the website, please also pay attention to the following to avoid deterioration of product performance.

1. Max three (3) times reflow is allowed.
In case of rework by soldering iron, its condition should be +350 °C max. + within 5 sec.
2. Applying excessive shock or vibration to the crystal unit may causes deterioration damage.
The product may be damaged depends on the condition such as shock in assembly machine.
Please check if your condition is safe in advance.
And in case of assembly condition change, please check it again in advance.
3. Shortest line pattern on PCB is recommended.
Too long line on PCB may causes abnormal oscillation.
4. Failures covered by free warranty period are limited to the cases where the product is used under the usage and environment described in the specifications. In addition, products that have been opened (including partially opened, modified, or intended to be opened) are not covered. In order to ensure frequency accuracy and prevent moisture condensation due to sudden temperature changes, it is recommended to store and use in normal room temperature and humidity.
If the product is stored for a long period (one year or more), please check solderability of the terminals before use.
5. Ultrasonic cleaning may cause resonant damage of the crystal unit depend on its condition.
Since we are unable to specify the conditions (type of cleaning unit, power, time, condition inside the bath, etc.) at your company, we cannot guarantee the performance of the product when it is cleaned by ultrasonic cleaner.
6. Condensation on oscillator circuit board may causes frequency shift or oscillation stop.
Please use the product under the condition there is no condensation.
7. If excessive drive level is applied to the crystal unit, it may cause performance deterioration and damages. Please design appropriate drive level on the circuit.
8. Characteristics differences between our measurement and your company's measurement may occur depending on measurement method and conditions. Please check it thoroughly before use.
9. Do not place signal lines, power lines, or GND lines in mounting area of the product, its inner layer, or its back side.
In order to avoid malfunction due to induction of other signal lines, please do not place signal lines near the product. It may affect product characteristics.
10. If there is no margin in negative resistance of the oscillator circuit, the crystal unit may not oscillate or may take a long time to oscillate. Therefore, negative resistance in the oscillator circuit should be at least five times of the crystal unit's equivalent series resistance. Please follow this circuit design rule.
11. Aging specifications are estimated value of frequency shift from reliability test results. It does not mean to guarantee product lifecycle.
12. If customer wants to use our product contrary to this caution and advice, please use it at your own risk.

<How to check the negative resistance>

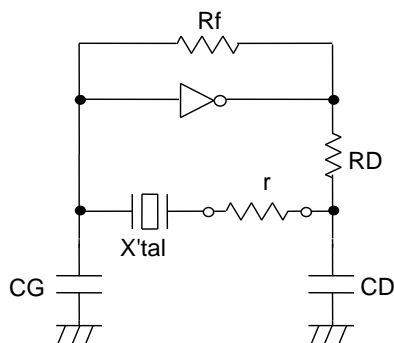

- 1) Insert a pure resistance " r " in series with the crystal oscillator.
- 2) Adjust " r " to find the maximum " r " value that starts oscillation
- 3) Look at the value of " r " in the oscillation state of 2).

Negative resistance of the circuit $|-R| =$

$r + \text{crystal unit series resistance value } R1$

Guideline for negative resistance $|-R|$:

$|-R| > R1 \text{ Max. } \times 5$

PROMOTION OF ENVIRONMENTAL MANAGEMENT SYSTEM CONFORMING TO INTERNATIONAL STANDARDS

At Seiko Epson, all environmental initiatives operate under the Plan-Do-Check-Action (PDCA) cycle designed to achieve continuous improvements. The environmental management system (EMS) operates under the ISO 14001 environmental management standard.

All of our major manufacturing and non-manufacturing sites, in Japan and overseas, completed the acquisition of ISO 14001 certification.



ISO 14000 is an international standard for environmental management that was established by the International Standards Organization in 1996 against the background of growing concern regarding global warming, destruction of the ozone layer, and global deforestation.

WORKING FOR HIGH QUALITY

In order provide high quality and reliable products and services than meet customer needs, Seiko Epson made early efforts towards obtaining ISO9000 series certification and has acquired ISO9001 for all business establishments in Japan and abroad. We have also acquired IATF 16949 certification that is requested strongly by major manufacturers as standard.

IATF 16949 is the international standard that added the sector-specific supplemental requirements for automotive industry based on ISO9001.

■ Explanation of marks used in this datasheet

	<p>● Pb free.</p>
	<p>● Complies with EU RoHS directive. *About the products without the Pb-free mark. Contains Pb in products exempted by EU RoHS directive (Contains Pb in sealing glass, high melting temperature type solder or other)</p>

NOTICE : PLEASE READ CAREFULLY BELOW BEFORE THE USE OF THIS DOCUMENT

- The content of this document is subject to change without notice. Before purchasing or using Epson products, please contact with sales representative of Seiko Epson Corporation ("Epson") for the latest information and be always sure to check the latest information published on Epson's official web sites and resources.
- This document may not be copied, reproduced, or used for any other purposes, in whole or in part, without Epson's prior consent.
- Information provided in this document including, but not limited to application circuits, programs and usage, is for reference purpose only. Epson makes no guarantees against any infringements or damages to any third parties' intellectual property rights or any other rights resulting from the information. This document does not grant you any licenses, any intellectual property rights or any other rights with respect to Epson products owned by Epson or any third parties.
- Epson has prepared this document carefully to be accurate and dependable, but Epson does not guarantee that the information is always accurate and complete. Epson assumes no responsibility for any damages you incurred due to any misinformation in this document.
- Epson products listed in this document and our associated technologies shall not be used in any equipment or systems that laws and regulations in Japan or any other countries prohibit to manufacture, use or sell. Furthermore, Epson products and our associated technologies shall not be used for the purposes of military weapons development (e.g. mass destruction weapons), military use, or any other military applications. If exporting Epson products or our associated technologies, please be sure to comply with the Foreign Exchange and Foreign Trade Control Act in Japan, Export Administration Regulations in the U.S.A (EAR) and other export-related laws and regulations in Japan and any other countries and to follow their required procedures.
- Epson assumes no responsibility for any damages (whether direct or indirect) caused by or in relation with your non-compliance with the terms and conditions in this document or for any damages (whether direct or indirect) incurred by any third party that you give, transfer or assign Epson products.
- For more details or other concerns about this document, please contact our sales representative.
- Company names and product names listed in this document are trademarks or registered trademarks of their respective companies.

● Disclaimer

- Epson products are designed for use in general electronic equipment applications that do not require extremely high reliability or safety.
- Epson does not represent or warrant that its products will not cause a failure for any particular application, except for cases where the failure is a direct result caused by defects in materials and workmanship of this product.
If a product fails due to defects in materials and workmanship, to the maximum extent permitted by law, we will, at our sole discretion, refund or replace the affected product.
- When products for used directly or indirectly in certain devices or applications (ex. Nuclear power, aerospace, infrastructure facilities, medical equipment, etc.) which are connected to or affect safety of human life or property, Customer is solely responsible for determining if the products and respective specifications are suitable for the intended use in particular customer applications.
Customer shall implement necessary and proper safety design and measures (including redundant design, malfunction prevention design, etc.) to ensure reliability and safety before using the products in/with customer's Equipment.
- No dismantling, analysis, reverse engineering, modification, alteration, adaptation, reproduction, etc., of Epson products is allowed.
Furthermore, any defects caused by this are not covered by the warranty.

©Seiko Epson Corporation 2025