

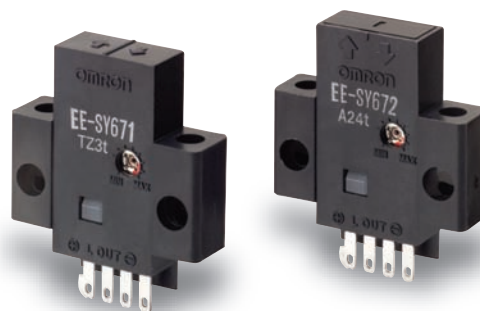

EE-SY671/672

Photomicrosensor with sensitivity adjuster.

- Easy adjustment with a built-in sensitivity adjuster.
- Easy optical axis monitoring with a bright light indicator.
- Compact design incorporating a built-in amplifier and special IC enables direct switching capacity of up to 100 mA.
- Wide operating voltage range: 5 to 24 VDC
- Connection possible with a range of ICs, relays, and Programmable Controllers (PLCs).





 Be sure to read *Safety Precautions* on page 4.

Ordering Information

Sensors

 Infrared light

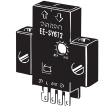
Appearance	Sensing method	Sensing distance	Output type	Output configuration	Model
Horizontal type 	Reflective type	 1 to 5 mm	NPN output	Dark-ON or Light-ON (Selectable) *	EE-SY671
Vertical type 					EE-SY672

* The Dark-ON/Light-ON (selectable) models are normally used as dark-ON models. To use them as light-ON models, short-circuit the L terminal and positive (+) terminal.
An EE-1001-1 Connector with the terminals already short-circuited is also available.

Accessories (Order Separately)

Type	Cable length	Model	Remarks	
Connector		EE-1001		
		EE-1001-1	L terminal and positive (+) terminal are already short-circuited.	
		EE-1009 *		
	Connector with Cable	1 m	EE-1006 1M	
			EE-1010 1M *	
	Connector with Cable	2 m	EE-1006 2M	
			EE-1010 2M *	
Connector with Robot Cable	1 m	EE-1010-R 1M *		
		EE-1010-R 2M *		
Connector Hold-down Clip		EE-1006A	Applicable Photomicrosensors For EE-SY671 and 672 only. (Can be used only with EE-1006 Connectors for the Photomicrosensors listed above.)	

Note: For details, refer to the Photomicro Sensors Accessories on EE-□ which can be accessed from your OMRON website.

* EE-1009- or EE-1010-series Connectors have a builtin locking mechanism to prevent cable disconnection when only the cable is pulled. To remove the Connector from the Sensor, grip the top and bottom of the Connector firmly and push into the Sensor once before pulling out. The locking mechanism prevents the Connector from being removed by pulling on the cable only and enables removal only when the Connector (housing) is pulled.

Ratings and Specifications

Item	Models	EE-SY671, EE-SY672
Sensing distance		1 to 5 mm (Reflection factor: 90%; white paper 15 × 15 mm)
Sensing object		Transparent or opaque: 15 × 15 mm min.
Differential distance		0.5 max. (with a sensing distance of 3 mm, horizontally)
Light source		GaAs infrared LED with a peak wavelength of 940 nm
Indicator *1		Light indicator (red)
Supply voltage		5 to 24 VDC ±10%, ripple (p-p): 10% max.
Current consumption		40 mA max.
Control output		NPN open collector: Load power supply voltage: 5 to 24 VDC Load current: 100 mA max. OFF current: 0.5 mA max. 100 mA load current with a residual voltage of 0.8 V max. 40 mA load current with a residual voltage of 0.4 V max.
Response frequency *2		50 Hz min. (Average: 500 Hz)
Ambient illumination *3		1,500 lx max. with fluorescent light on the surface of the receiver
Ambient temperature range		Operating: -25 to +55°C Storage: -30 to +80°C
Ambient humidity range		Operating: 5% to 85% Storage: 5% to 95%
Vibration resistance		Destruction: 20 to 2,000 Hz (peak acceleration: 100 m/s ²) 1.5-mm double amplitude for 2 h (4-min periods) each in X, Y, and Z directions
Shock resistance		Destruction: 500m/s ² for 3 times each in X, Y, and Z directions
Degree of protection		IEC IP50
Connecting method		Special connector (direct soldering possible)
Weight		Approx. 3.5 g (including screwdriver for adjustment)
Material	Case	Polybutylene phthalate (PBT)
	Emitter/receiver	Polycarbonate
Accessories		Screwdriver for adjustment

*1. The indicator is a GaP red LED (peak wavelength: 690 nm).

*2. The response frequency was measured by detecting the following rotating disk.

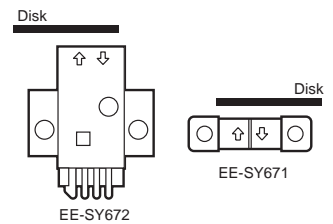
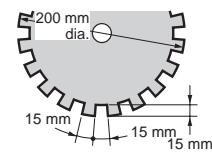

*3. The ambient illuminance is measured on the surface of the receiver.

Engineering Data (Reference Value)

Operating Range Characteristics (Max. Sensitivity)

EE-SY67□

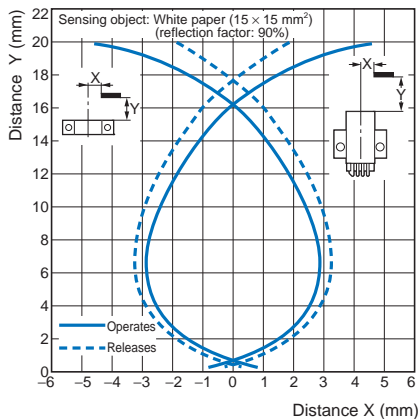

EE-SY67□

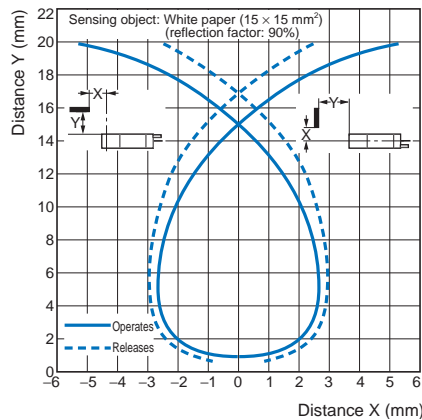

Sensing Distance vs. Object Area Characteristics

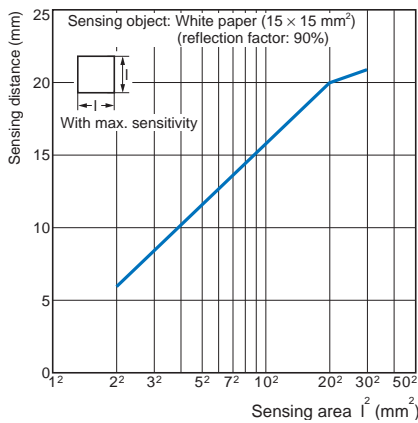

Sensing Distance vs. Sensitivity Volume

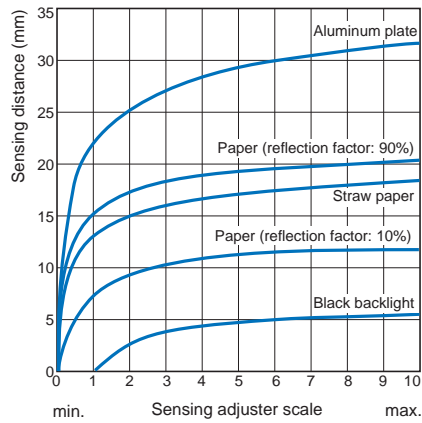

I/O Circuit Diagrams

NPN Output

Model	Output configuration	Timing charts	Terminal connections	Output circuit
EE-SY671 EE-SY672	Light-ON	Incident Interrupted Light indicator (red) ON OFF Output transistor ON OFF Load 1 (relay) Operates Releases	Short-circuited between ⓪ terminal and positive ⊕ terminal	
	Dark-ON	Incident Interrupted Light indicator (red) ON OFF Output transistor ON OFF Load 1 (relay) Operates Releases	Open between ⓪ terminal and positive ⊕ terminal	

Safety Precautions

Refer to *Warranty and Limitations of Liability*.

⚠ WARNING

This product is not designed or rated for ensuring safety of persons either directly or indirectly. Do not use it for such purposes.



Precautions for Correct Use

Make sure that this product is used within the rated ambient environment conditions.

● **Wiring**

Soldering

- When direct soldering to the terminal, use the following guidelines.

Soldering Conditions

Item	Temperature	Permissible time	Remarks
Soldering iron	350°C max.	3 s max.	The portion between the base of the terminals and the position 1.5 mm from the terminal base must not be soldered.

- The terminal base uses a polycarbonate resin, which could be deformed by excessive soldering heat, resulting in damage to the product's functionality.

Cable Extension

- When extending the cable, use an extension cable with conductors having a total cross-section area of 0.3 mm². The total cable length must be less than 10 m.

● **Installation**

The photomicrosensor is built into the device being used and so is not equipped to deal with interference from an external light source. When using the sensor in an area exposed to an incandescent lamp, install so as to minimize the effects of external light sources.

● **Sensitivity Adjustment**

Use the special screwdriver (sold together) for sensitivity adjustment.

- When an excessive force is applied to sensitivity adjuster, it may be damaged.
- The shaft of the sensitivity adjuster is charged. Connect a DC power supply incorporating an insulated transformer to the photomicrosensor. Do not connect a DC power supply incorporating an autotransformer or the user may receive an electric shock when adjusting the sensitivity.

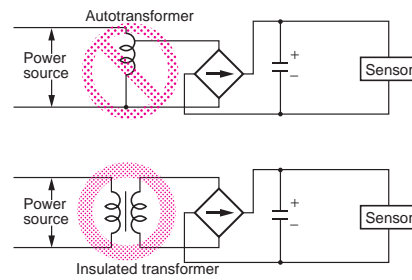

Sensitivity Adjustment with Background Object

		Point A	Point B	Setting	Check
Sensing conditions	Adjuster indicator				
		<p>1. Set the sensitivity of the photomicrosensor to minimum, place the sensing object in the sensing position, turn the sensitivity adjuster clockwise slowly until the light indicator is lit (point A).</p>	<p>2. Remove the sensing object, at which time the light indicator will be OFF. Further turn the sensitivity adjuster clockwise slowly until the light indicator is lit again (point B). The operation indicator will not light again if the background object does not reflect light, in which case refer to "Sensitivity Adjustment with No Background Object".</p>	<p>3. Set the sensitivity adjuster at the center (point C) between point A and B. Points A and B will be very close if the sensor is influenced by excessive light reflected by the background object, in which case take the following preventive measures.</p> <p>(1) Separate the sensor and the background object by a distance of 20 mm min.</p> <p>(2) Cover the surface of the background object with a material with a small reflection factor, such as black sponge.</p>	<p>4. After setting the sensitivity adjuster to point C, check if the light indicator is lit on placing the sensing object at the sensing position and not lit on removing the sensing object.</p>

Sensitivity Adjustment with No Background Object

		Point A	Point B	Check
Sensing conditions	Adjuster indicator			
		<p>1. Set the sensitivity of the photomicrosensor to minimum, place the sensing object at the sensing position, turn the sensitivity adjuster clockwise slowly until the light indicator is lit (point A).</p>	<p>2. Set the sensitivity adjuster at the center (point C) between points A and B (the point where the sensitivity is maximum).</p>	<p>3. After setting the sensitivity adjuster to point C, check if the light indicator is not lit on removing the sensing object.</p>

Dimensions

Tolerance class IT16 applies to dimensions in this datasheet unless otherwise specified.

Sensors

EE-SY671

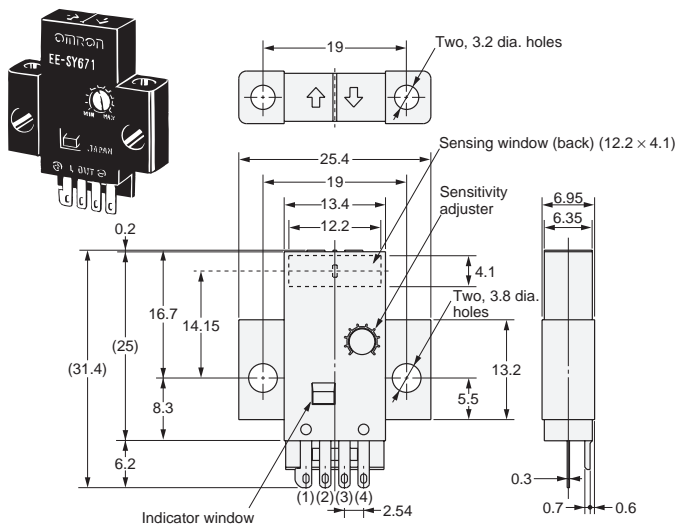

Terminal Arrangement

(1)	+	Vcc
(2)	L	L
(3)	OUT	OUTPUT
(4)	-	GND (0 V)

EE-SY672

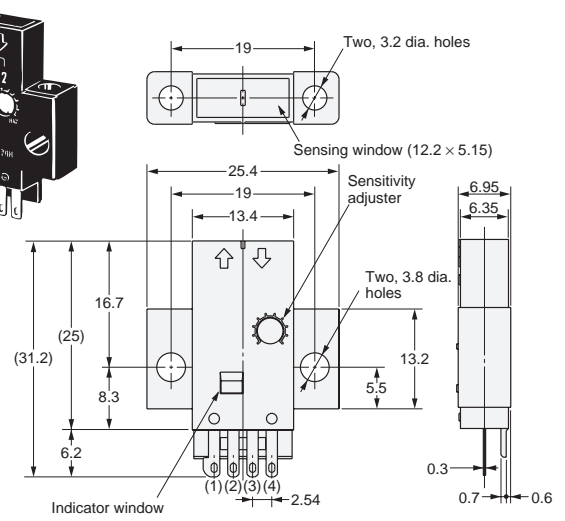

Terminal Arrangement

(1)	+	Vcc
(2)	L	L
(3)	OUT	OUTPUT
(4)	-	GND (0 V)

Accessories (Order Separately)

* Refer to *Accessories* for details.

Terms and Conditions Agreement

Read and understand this catalog.

Please read and understand this catalog before purchasing the products. Please consult your OMRON representative if you have any questions or comments.

Warranties.

(a) Exclusive Warranty. Omron's exclusive warranty is that the Products will be free from defects in materials and workmanship for a period of twelve months from the date of sale by Omron (or such other period expressed in writing by Omron). Omron disclaims all other warranties, express or implied.

(b) Limitations. OMRON MAKES NO WARRANTY OR REPRESENTATION, EXPRESS OR IMPLIED, ABOUT NON-INFRINGEMENT, MERCHANTABILITY OR FITNESS FOR A PARTICULAR PURPOSE OF THE PRODUCTS. BUYER ACKNOWLEDGES THAT IT ALONE HAS DETERMINED THAT THE PRODUCTS WILL SUITABLY MEET THE REQUIREMENTS OF THEIR INTENDED USE.

Omron further disclaims all warranties and responsibility of any type for claims or expenses based on infringement by the Products or otherwise of any intellectual property right. (c) Buyer Remedy. Omron's sole obligation hereunder shall be, at Omron's election, to (i) replace (in the form originally shipped with Buyer responsible for labor charges for removal or replacement thereof) the non-complying Product, (ii) repair the non-complying Product, or (iii) repay or credit Buyer an amount equal to the purchase price of the non-complying Product; provided that in no event shall Omron be responsible for warranty, repair, indemnity or any other claims or expenses regarding the Products unless Omron's analysis confirms that the Products were properly handled, stored, installed and maintained and not subject to contamination, abuse, misuse or inappropriate modification. Return of any Products by Buyer must be approved in writing by Omron before shipment. Omron Companies shall not be liable for the suitability or unsuitability or the results from the use of Products in combination with any electrical or electronic components, circuits, system assemblies or any other materials or substances or environments. Any advice, recommendations or information given orally or in writing, are not to be construed as an amendment or addition to the above warranty.

See <http://www.omron.com/global/> or contact your Omron representative for published information.

Limitation on Liability; Etc.

OMRON COMPANIES SHALL NOT BE LIABLE FOR SPECIAL, INDIRECT, INCIDENTAL, OR CONSEQUENTIAL DAMAGES, LOSS OF PROFITS OR PRODUCTION OR COMMERCIAL LOSS IN ANY WAY CONNECTED WITH THE PRODUCTS, WHETHER SUCH CLAIM IS BASED IN CONTRACT, WARRANTY, NEGLIGENCE OR STRICT LIABILITY.

Further, in no event shall liability of Omron Companies exceed the individual price of the Product on which liability is asserted.

Suitability of Use.

Omron Companies shall not be responsible for conformity with any standards, codes or regulations which apply to the combination of the Product in the Buyer's application or use of the Product. At Buyer's request, Omron will provide applicable third party certification documents identifying ratings and limitations of use which apply to the Product. This information by itself is not sufficient for a complete determination of the suitability of the Product in combination with the end product, machine, system, or other application or use. Buyer shall be solely responsible for determining appropriateness of the particular Product with respect to Buyer's application, product or system. Buyer shall take application responsibility in all cases.

NEVER USE THE PRODUCT FOR AN APPLICATION INVOLVING SERIOUS RISK TO LIFE OR PROPERTY OR IN LARGE QUANTITIES WITHOUT ENSURING THAT THE SYSTEM AS A WHOLE HAS BEEN DESIGNED TO ADDRESS THE RISKS, AND THAT THE OMRON PRODUCT(S) IS PROPERLY RATED AND INSTALLED FOR THE INTENDED USE WITHIN THE OVERALL EQUIPMENT OR SYSTEM.

Programmable Products.

Omron Companies shall not be responsible for the user's programming of a programmable Product, or any consequence thereof.

Performance Data.

Data presented in Omron Company websites, catalogs and other materials is provided as a guide for the user in determining suitability and does not constitute a warranty. It may represent the result of Omron's test conditions, and the user must correlate it to actual application requirements. Actual performance is subject to the Omron's Warranty and Limitations of Liability.

Change in Specifications.

Product specifications and accessories may be changed at any time based on improvements and other reasons. It is our practice to change part numbers when published ratings or features are changed, or when significant construction changes are made. However, some specifications of the Product may be changed without any notice. When in doubt, special part numbers may be assigned to fix or establish key specifications for your application. Please consult with your Omron's representative at any time to confirm actual specifications of purchased Product.

Errors and Omissions.

Information presented by Omron Companies has been checked and is believed to be accurate; however, no responsibility is assumed for clerical, typographical or proofreading errors or omissions.