

## Automotive 170 V, dual 30 A lowdrop power Schottky rectifier

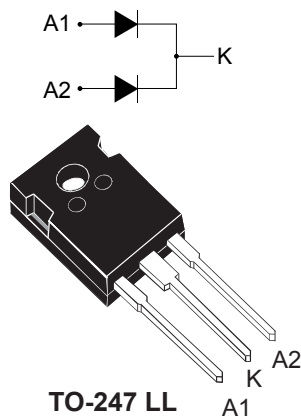

## Features

- AEC-Q101 qualified 
- Avalanche capability
- 175 °C maximum operating junction temperature
- $V_{RRM}$  guaranteed from -40 °C to +175 °C
- PPAP capable
- ECOPACK2 compliant

## Applications

- DC/DC converter
- Freewheeling diodes
- LLC topology
- Phase shift topology
- Electrical vehicles (EV) and Hybrid electrical vehicles

## Description

The STPS61170C-Y has been developed for applications requiring a high-voltage secondary rectification diode, and in particular for DC/DC converters used in electrical cars.

Product status	
STPS61170C-Y	
Product summary	
$I_{F(AV)}$	2 x 30 A
$V_{RRM}$	170 V
$T_{j(max.)}$	175 °C
$V_F(typ.)$	0.64 V

# 1 Characteristics

**Table 1. Absolute ratings (limiting values per diode at 25 °C, unless otherwise specified)**

Symbol	Parameter	Value	Unit	
V <sub>RRM</sub>	Repetitive peak reverse voltage (T <sub>j</sub> = -40 °C to +175 °C)	170	V	
I <sub>F(RMS)</sub>	Forward rms current	80	A	
I <sub>F(AV)</sub>	Average forward current, δ = 0.5, square wave	T <sub>c</sub> = 160 °C Per diode	30	A
		T <sub>c</sub> = 160 °C Per device	60	
I <sub>FSM</sub>	Surge non repetitive forward current	t <sub>p</sub> = 10 ms sinusoidal	500	A
P <sub>ARM</sub>	Repetitive peak avalanche power	t <sub>p</sub> = 10 μs, T <sub>j</sub> = 125 °C	2290	W
T <sub>stg</sub>	Storage temperature range	-65 to +175	°C	
T <sub>j</sub>	Maximum operating junction temperature <sup>(1)</sup>	+175	°C	

1. (dP<sub>tot</sub>/dT<sub>j</sub>) < (1/R<sub>th(j-a)</sub>) condition to avoid thermal runaway for a diode on its own heatsink.

**Table 2. Thermal resistance parameters**

Symbol	Parameter	Typ. value	Unit
R <sub>th(j-c)</sub>	Junction to case	Per diode	0.34
		Total	0.17

For more information, please refer to the following application note :

- AN5088 : Rectifiers thermal management, handling and mounting recommendations

**Table 3. Static electrical characteristics (per diode)**

Symbol	Parameter	Test conditions	Min.	Typ.	Max.	Unit	
I <sub>R</sub> <sup>(1)</sup>	Reverse leakage current	T <sub>j</sub> = 25 °C	V <sub>R</sub> = 170 V	-		60	μA
		T <sub>j</sub> = 125 °C		-	16	60	mA
V <sub>F</sub> <sup>(2)</sup>	Forward voltage drop	T <sub>j</sub> = 25 °C	I <sub>F</sub> = 30 A	-		0.84	V
		T <sub>j</sub> = 125 °C		-	0.64	0.69	
		T <sub>j</sub> = 25 °C	I <sub>F</sub> = 60 A	-		0.94	
		T <sub>j</sub> = 125 °C		-	0.76	0.81	

1. Pulse test: t<sub>p</sub> = 5 ms, δ < 2%

2. Pulse test: t<sub>p</sub> = 380 μs, δ < 2%

To evaluate the conduction losses, use the following equation: P = 0.57 x I<sub>F(AV)</sub> + 0.004 x I<sub>F</sub><sup>2</sup> (RMS)

For more information, please refer to the following application notes related to the power losses :

- AN604: Calculation of conduction losses in a power rectifier
- AN4021: Calculation of reverse losses on a power diode

### 1.1 Characteristics (curves)

**Figure 1. Average forward current versus case temperature ( $\delta = 0.5$ , per diode)**

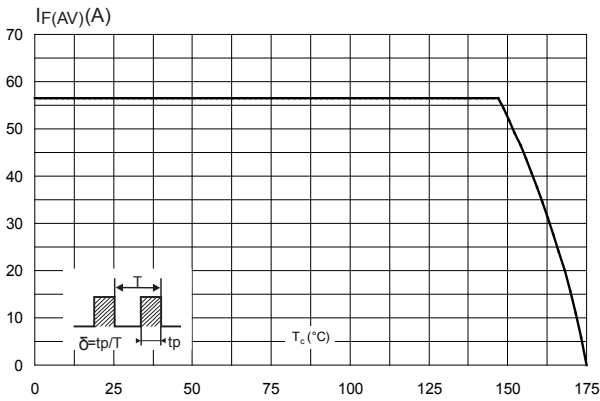

**Figure 2. Normalized avalanche power derating versus pulse duration ( $T_j = 125^\circ\text{C}$ )**

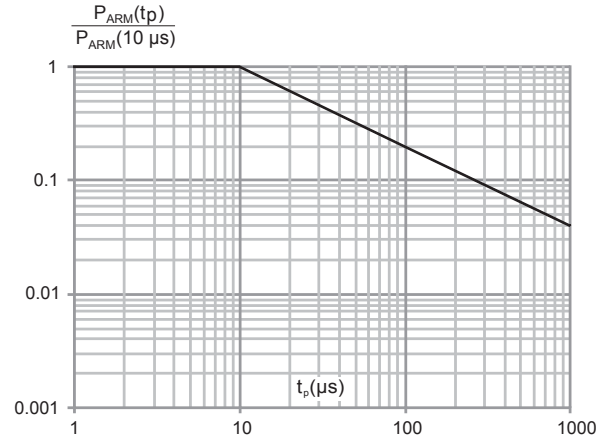

**Figure 3. Relative variation of thermal impedance junction to case versus pulse duration**

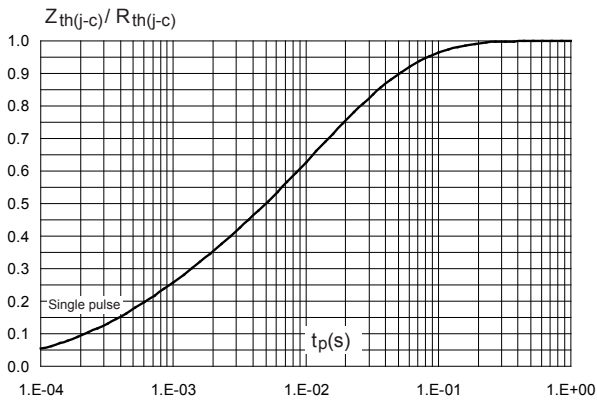

**Figure 4. Reverse leakage current versus reverse voltage applied (typical values, per diode)**

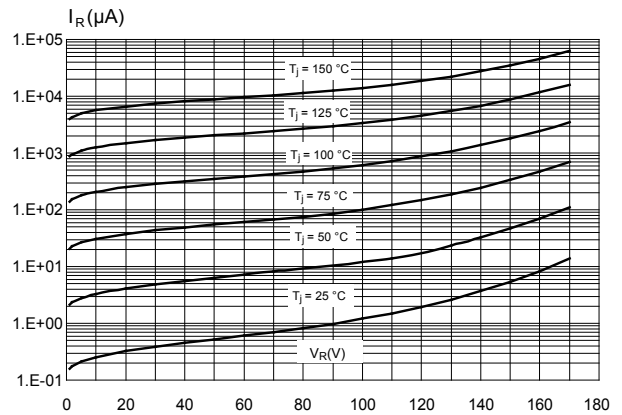

**Figure 5. Junction capacitance versus reverse voltage applied (typical values, per diode)**

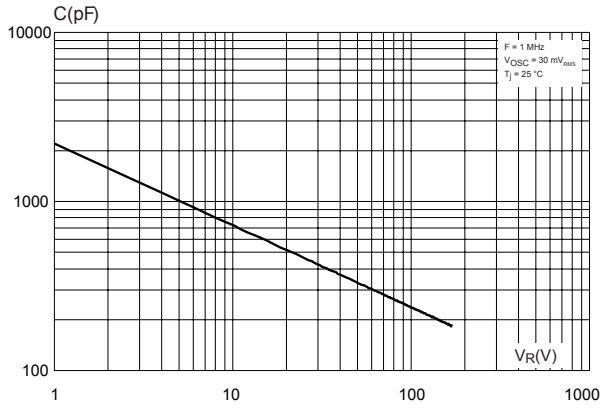

**Figure 6. Forward voltage drop versus forward current (typical values, per diode)**

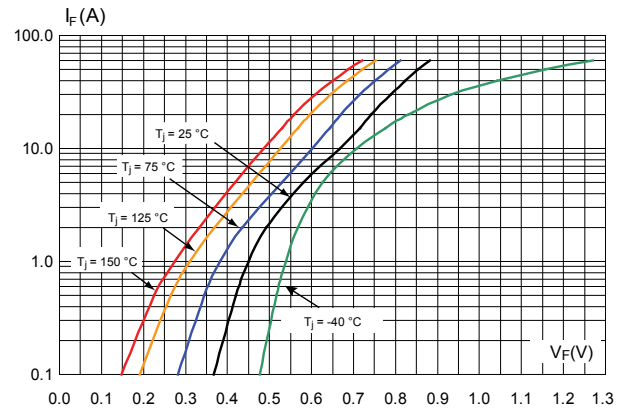

## 2 Package information

In order to meet environmental requirements, ST offers these devices in different grades of **ECOPACK** packages, depending on their level of environmental compliance. ECOPACK specifications, grade definitions and product status are available at: [www.st.com](http://www.st.com). ECOPACK is an ST trademark.

### 2.1 TO-247 package\_information

- Epoxy meets UL94, V0
- Cooling method: by conduction (C)
- Recommended torque value: 0.8 to 1.0 N·m

Figure 7. TO-247 long leads package outline

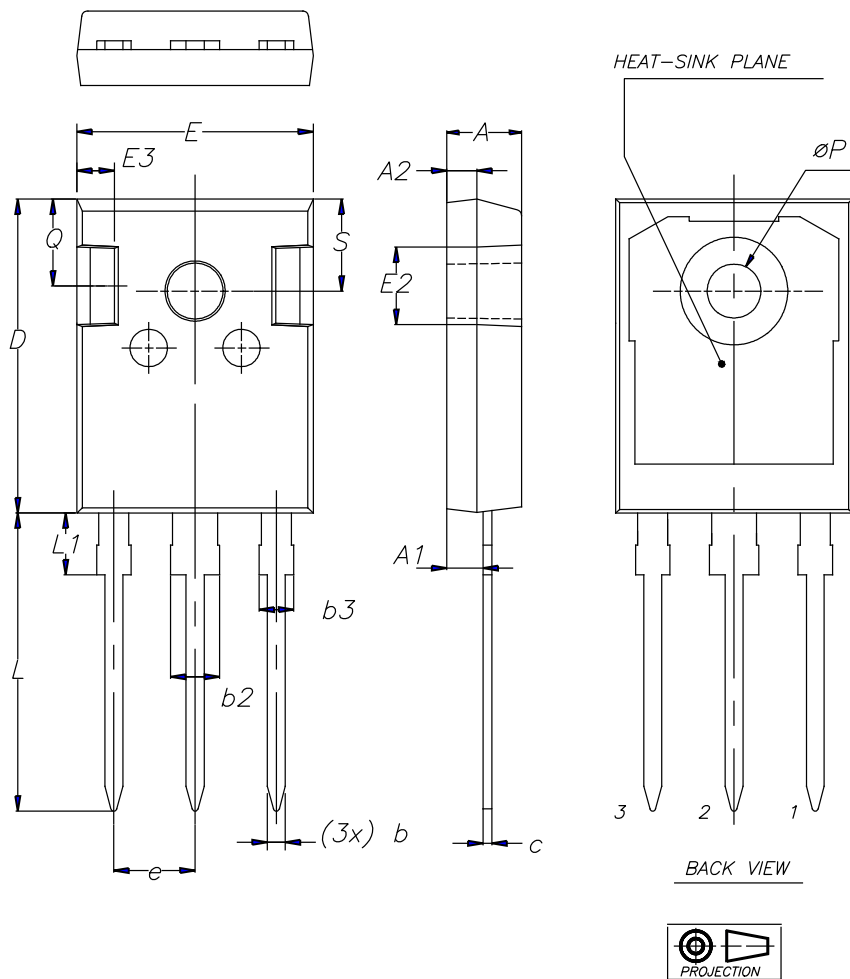

**Table 4. TO-247 long leads package mechanical data**

Dim.	mm.			Inches		
	Min.	Typ.	Max.	Min.	Typ.	Max.
A	4.90		5.15	0.192		0.203
A1	2.25		2.55	0.088		0.101
A2	1.85		2.10	0.072		0.083
B	1.07		1.32	0.042		0.052
B2	2.87		3.38	0.112		0.134
B3	1.90		2.38	0.074		0.094
C	0.55		0.67	0.021		0.027
D	20.82		21.10	0.819		0.831
E	15.70		16.02	0.618		0.631
E2	4.90		5.10	0.192		0.201
E3	2.40		2.60	0.094		0.103
e	5.34		5.54	0.210		0.219
L	19.80		20.30	0.779		0.800
L1	4.16		4.47	0.163		0.176
P	3.50		3.70	0.137		0.146
Q	5.49		6.00	0.216		0.237
S	6.04		6.29	0.237		0.248

### 3 Ordering information

**Table 5. Order code**

Order code	Marking	Package	Weight	Base qty.	Delivery mode
STPS61170CWLY	STPS61170CWLY	TO-247 LL	4.36 g	30	Tube

## Revision history

**Table 6. Document revision history**

Date	Revision	Changes
20-Nov-2019	1	First issue.

**IMPORTANT NOTICE – PLEASE READ CAREFULLY**

STMicroelectronics NV and its subsidiaries (“ST”) reserve the right to make changes, corrections, enhancements, modifications, and improvements to ST products and/or to this document at any time without notice. Purchasers should obtain the latest relevant information on ST products before placing orders. ST products are sold pursuant to ST’s terms and conditions of sale in place at the time of order acknowledgement.

Purchasers are solely responsible for the choice, selection, and use of ST products and ST assumes no liability for application assistance or the design of Purchasers’ products.

No license, express or implied, to any intellectual property right is granted by ST herein.

Resale of ST products with provisions different from the information set forth herein shall void any warranty granted by ST for such product.

ST and the ST logo are trademarks of ST. For additional information about ST trademarks, please refer to [www.st.com/trademarks](http://www.st.com/trademarks). All other product or service names are the property of their respective owners.

Information in this document supersedes and replaces information previously supplied in any prior versions of this document.

© 2019 STMicroelectronics – All rights reserved