

SPDL



Single Phase Compact Power Supply



Description

The SPDL series of DIN-rail mount power supplies encompasses high performance within an extremely compact footprint. Power ratings are available in 15, 30, 60, 75, 120, 240 and 480 W, with 12, 24 or 48 VDC output. The SPDL achieves high operating efficiency of up to 95% @ 230 VAC. Features such as DC ok output relay (for SPDL 240 and 480 W model) and built-in protection functions ensure a high degree of reliability during operation.

All specifications are at nominal values, full load, 25°C unless otherwise stated.

Benefits

- **Compact dimensions.** SPDL can save up to 50% panel-width space thanks to its ultra-slim design. All models are just 32 mm wide, except 45mm for 480 W.
- **High efficiency.** The built-in PFC (in SPDL 240 and 480 W models) results in high operating efficiency up to 95%.
- **Flexible installation.** Universal AC/DC input range with AC voltage (90 VAC to 264 VAC) or with DC voltage (120 VDC to 370 VDC).
- **Integrated protection.** Output short circuit, over-current, over-voltage, over-temperature protection.
- **Wide operating temperature.** SPDL models can work in extreme temperatures up to -40°C to 80°C (-40°F to 176°F).
- **High altitude.** SPDL series assures the operating altitude up to 5000m.
- **High degree of reliability.** Built-in active PFC (only in SPDL 240 and 480 W models) and DC OK Relay Contact (only in SPDLxx2401R and SPDLxx4801R models) assure high degree of reliability during the operations.

Applications

Installations with limited panel space, industrial equipment, machinery.

Main functions

- Output short circuit, over-current, over-voltage and over-temperature protection
- DC OK relay indication (only in SPDL 240 and 480 W models)
- Built-in active PFC (only in SPDL 240 and 480 W models)

References

Order code

 SPDL 1

Enter the code entering the corresponding option instead of .

Code	Option	Description	Notes
S	-	Switching	Device typology
P	-	Power	
D	-	DIN rail	
L	-	Light	
<input type="checkbox"/>	12	12 VDC	Rated output voltage
	24	24 VDC	
	48	48 VDC	
<input type="checkbox"/>	15	15 W	Rated output power
	30	30 W	
	60	60 W	
	75	75 W	
	120	120 W	
	240	240 W	
	480	480 W	
1	-	Single phase input	Input type
<input type="checkbox"/>	-	-	
	R	Relay output	

Selection guide

Output Voltage	Output power						
	15 W	30 W	60 W	75 W	120 W	240 W	480 W
12 VDC	SPDL12151	SPDL12301	SPDL12601	SPDL12751	-	-	-
24 VDC	SPDL24151	SPDL24301	SPDL24601	SPDL24751	SPDL241201	SPDL242401R	SPDL244801 SPDL244801R
48 VDC	-	-	-	-	-	-	SPDL484801 SPDL484801R

Further reading

Information	Where to find it	QR code
SPDL datasheet	https://www.gavazziautomation.com/fileadmin/images/PIM/DATASHEET/ENG/SPDL_DS_EN.pdf	
SPDL installation sheet	https://www.gavazziautomation.com/fileadmin/images/PIM/MANUALS/ENG/SPDL_IM.pdf	

Structure

SPDL 15 W



Element	Component	Function
A	- V terminals	Negative DC Output terminals
B	+ V terminals	Positive DC Output terminals
C	VADJ trimmer	Output voltage adjustment
D	DC OK LED	Green when output voltage is active
E	Input terminals	L, N supply terminals and Protective Earth (PE)

SPDL 30 W



Element	Component	Function
A	- V terminals	Negative DC Output terminals
B	+ V terminals	Positive DC Output terminals
C	VADJ trimmer	Output voltage adjustment
D	DC OK LED	Green when output voltage is active
E	Input terminals	L, N supply terminals and Protective Earth (PE)

SPDL 60 W



Element	Component	Function
A	- V terminals	Negative DC Output terminals
B	+ V terminals	Positive DC Output terminals
C	VADJ trimmer	Output voltage adjustment
D	DC OK LED	Green when output voltage is active
E	Input terminals	L, N supply terminals and Protective Earth (PE)

SPDL 75 W

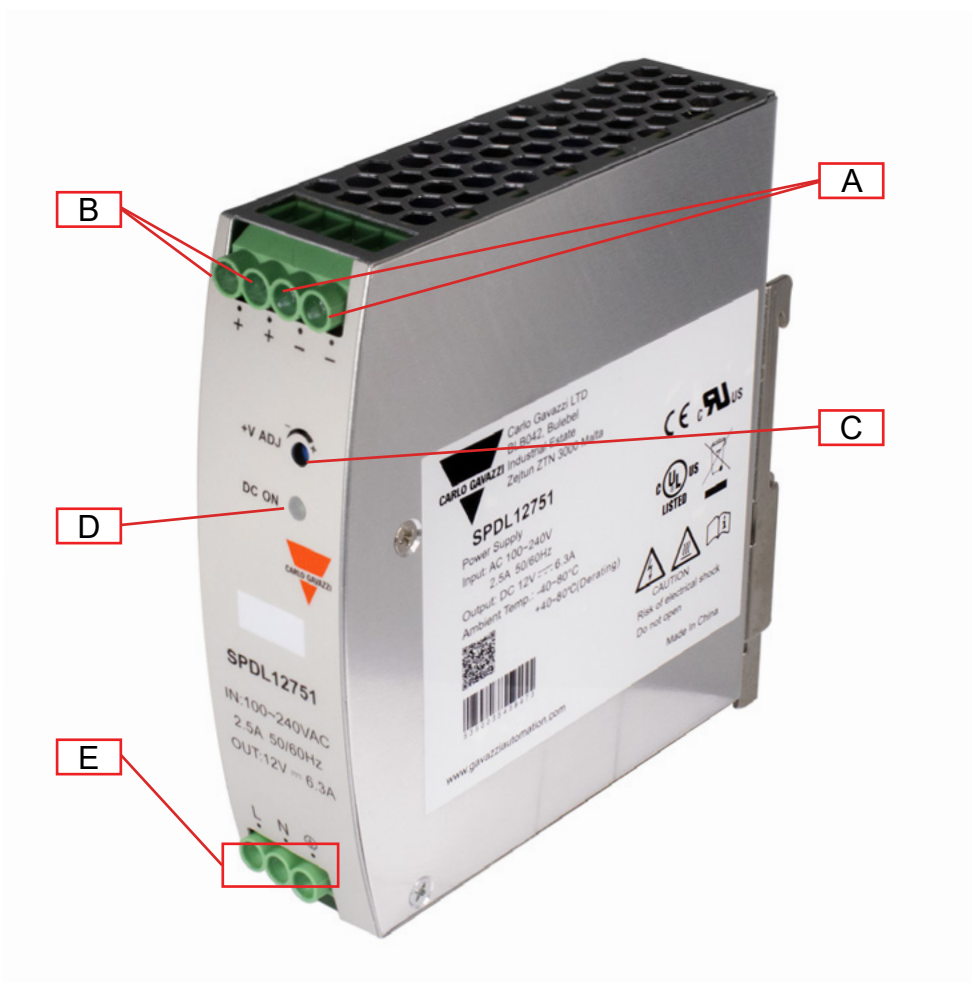

Element	Component	Function
A	- V terminals	Negative DC Output terminals
B	+ V terminals	Positive DC Output terminals
C	VADJ trimmer	Output voltage adjustment
D	DC OK LED	Green when output voltage is active
E	Input terminals	L, N supply terminals and Protective Earth (PE)

SPDL 120 W

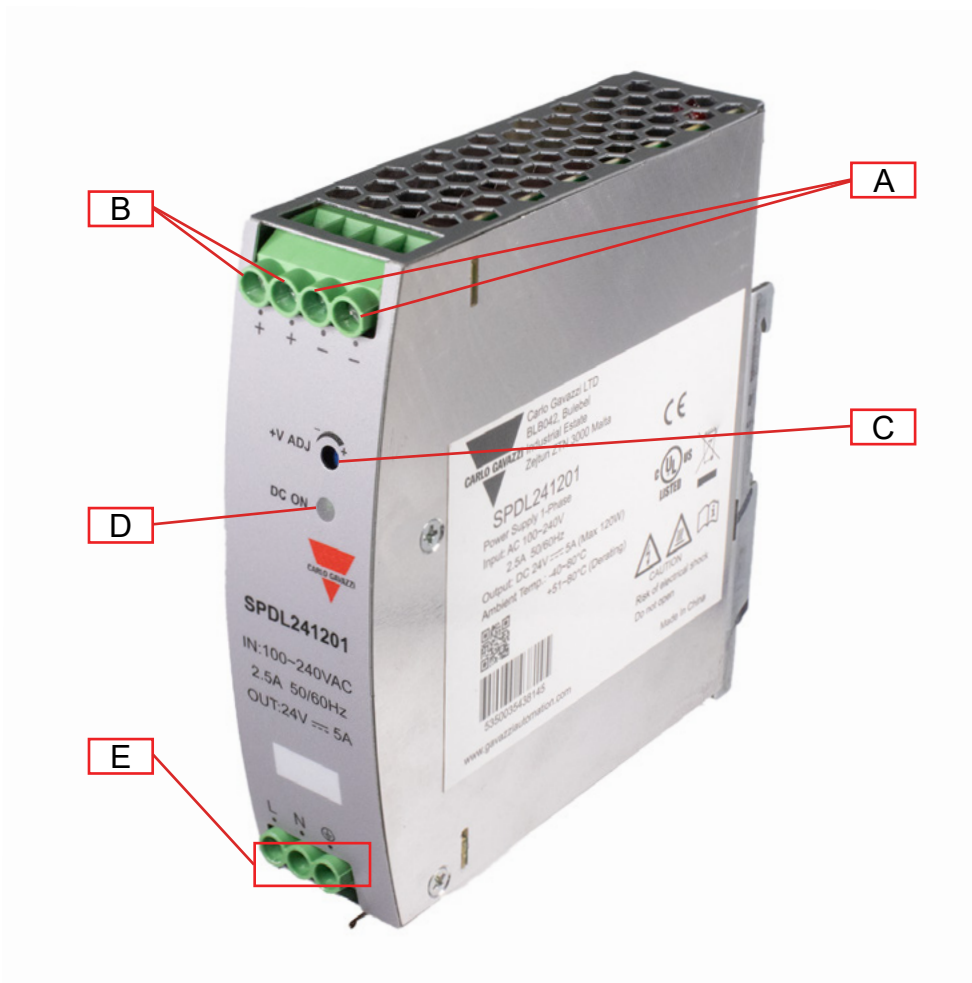

Element	Component	Function
A	- V terminals	Negative DC Output terminals
B	+ V terminals	Positive DC Output terminals
C	VADJ trimmer	Output voltage adjustment
D	DC OK LED	Green when output voltage is active
E	Input terminals	L, N supply terminals and Protective Earth (PE)

SPDL 240 W

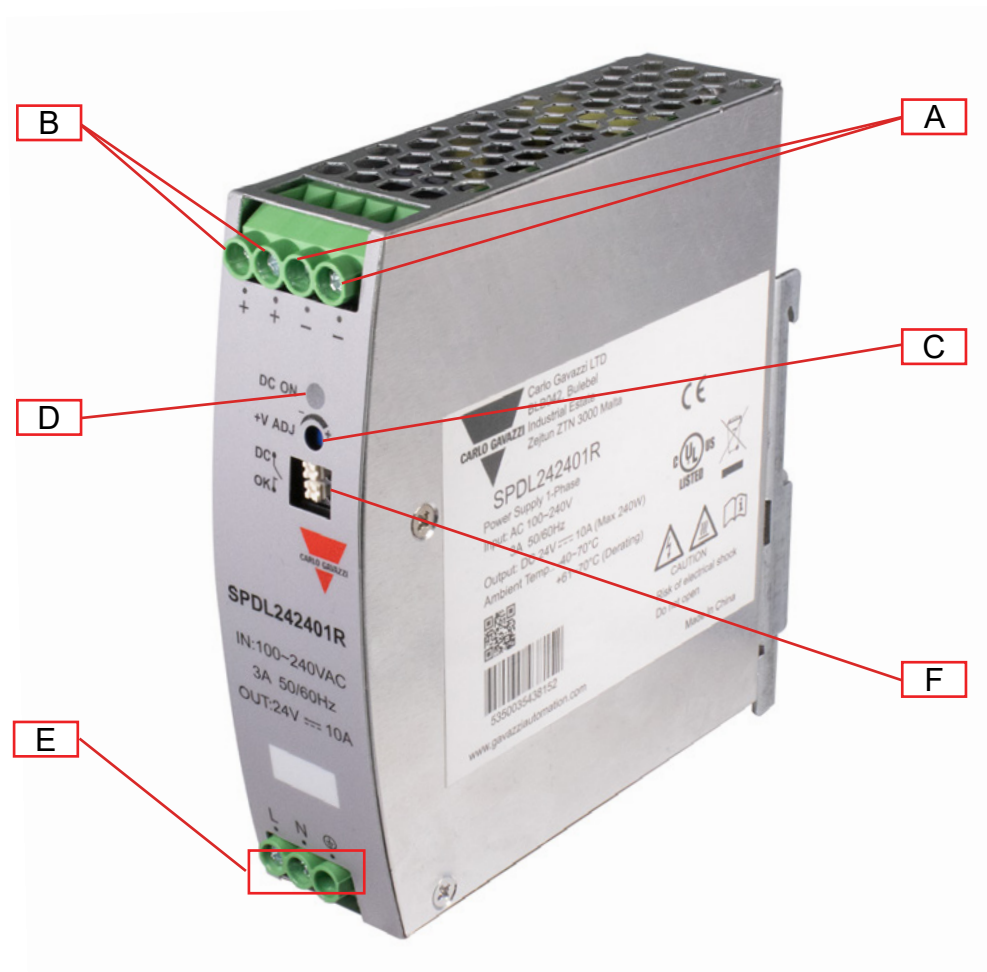

Element	Component	Function
A	- V terminals	Negative DC Output terminals
B	+ V terminals	Positive DC Output terminals
C	VADJ trimmer	Output voltage adjustment
D	DC OK LED	Green when output voltage is active
E	Input terminals	L, N supply terminals and Protective Earth (PE)
F	DC OK relay	Relay rating: 30 VDC / 1 A max. or 60 VDC / 0.3 A max. or 30 VAC / 0.3 A max. (resistive load) Relay contacts closed when output voltage \geq 90% of rated output voltage.

SPDL 480 W

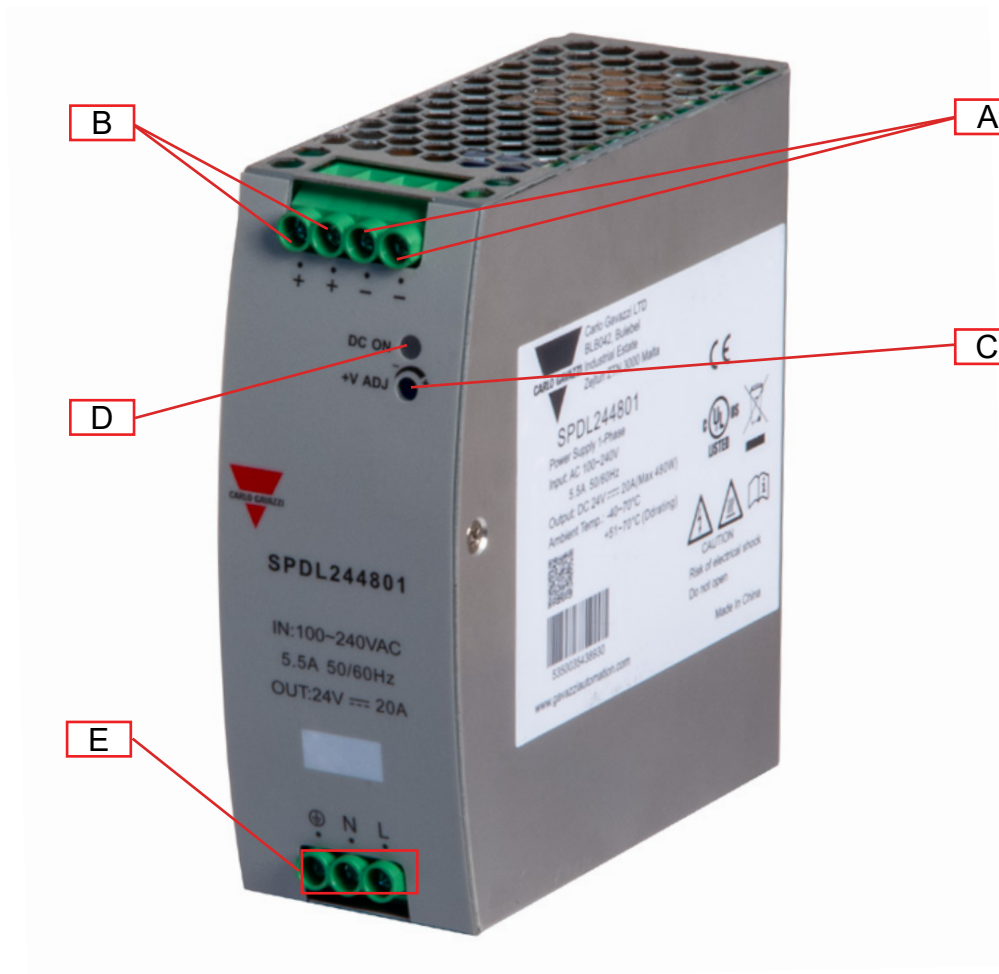

Element	Component	Function
A	- V terminals	Negative DC Output terminals
B	+ V terminals	Positive DC Output terminals
C	VADJ trimmer	Output voltage adjustment
D	DC OK LED	Green when output voltage is active
E	Input terminals	L, N supply terminals and Protective Earth (PE)

SPDL 480 R

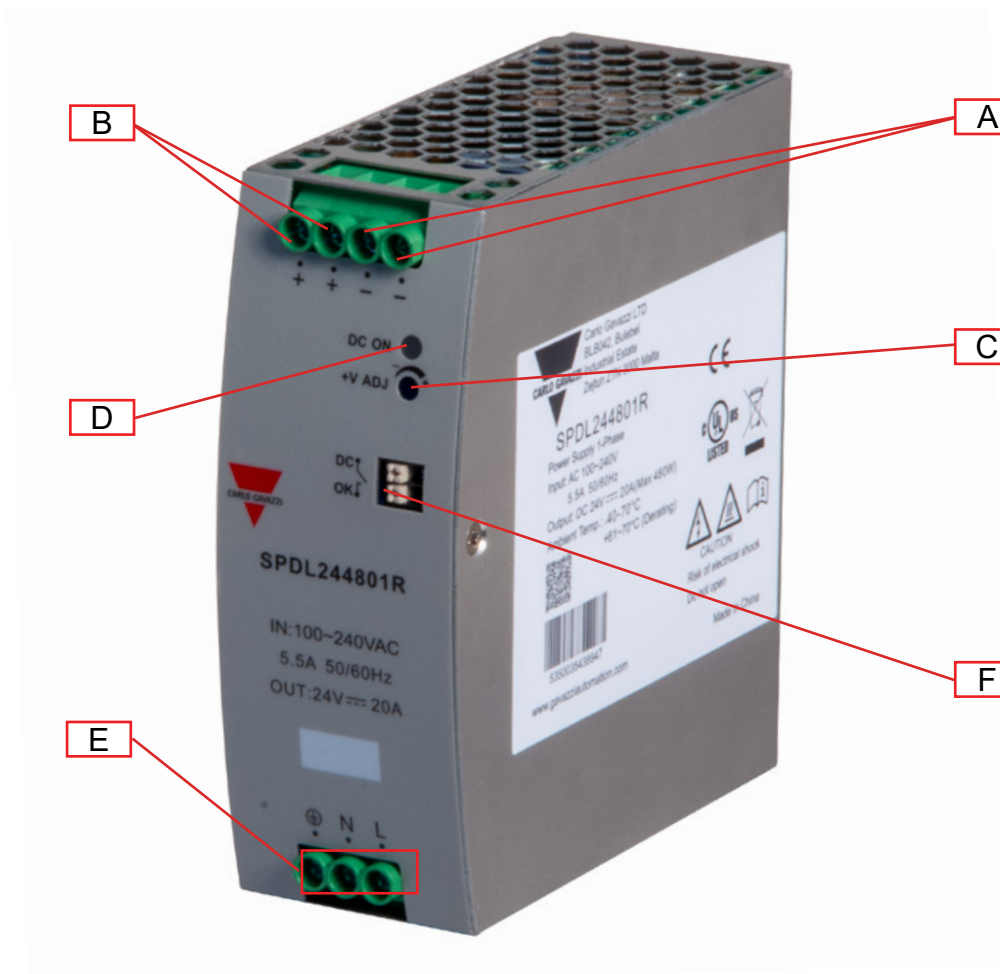

Element	Component	Function
A	- V terminals	Negative DC Output terminals
B	+ V terminals	Positive DC Output terminals
C	VADJ trimmer	Output voltage adjustment
D	DC OK LED	Green when output voltage is active
E	Input terminals	L, N supply terminals and Protective Earth (PE)
F	DC OK relay	Relay rating: 30 VDC / 1 A max. or 60 VDC / 0.3 A max. or 30 VAC / 0.3 A max. (resistive load) Relay contacts closed when output voltage \geq 90% of rated output voltage.

Features

General data

	15 W	30 W	60 W	75 W	120 W	240 W	480 W	480 W R
Leakage current	I/O: < 0.25 mA I/PE: < 3.5 mA (264 VAC / 63 Hz)			< 1.0 mA (240 VAC, 63 Hz)	< 1.0 mA (240 VAC, 63 Hz)	I/O: < 0.25 mA I/PE: < 3.5 mA (264 VAC / 63 Hz)	I/O: < 0.25 mA I/PE: < 3.5 mA (264 VAC / 63 Hz)	
Efficiency @ 230 VAC								
12 VDC	83 %	82 %	86 %	85.5 %	-	-	-	-
24 VDC	84.5 %	85 %	88 %	88 %	88.5 %	95 %	94 %	95 %
48 VDC	-	-	-	-	-	-	94 %	95 %
Power loss @ nominal load	115 VAC	-	-	-	-	>0.98	>0.99	
	230 VAC	-	-	-	-	>0.95	>0.95	
Ingress protection	IP20							
MTBF (MIL-HDBK-217F)	590,000 h			200,000 h	>200,000 h	≥300,000 h		
Case material	Plastic			Metal				
Weight	159 g	170 g	220 g	380 g		540 g	752g	757g
Mounting	DIN rail							

Dimensions

SPDL 15 W

Unit: mm [inch]

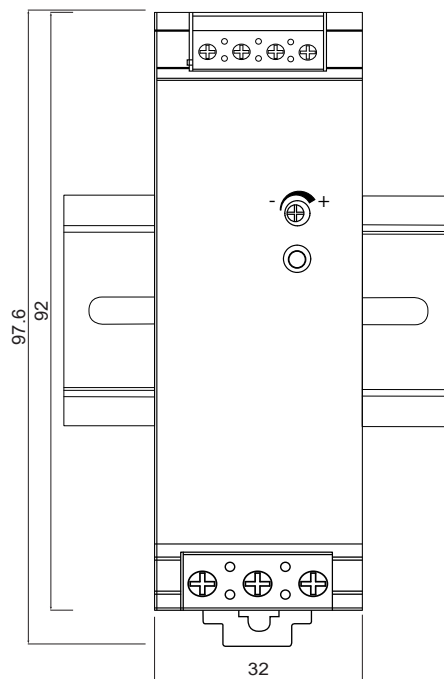
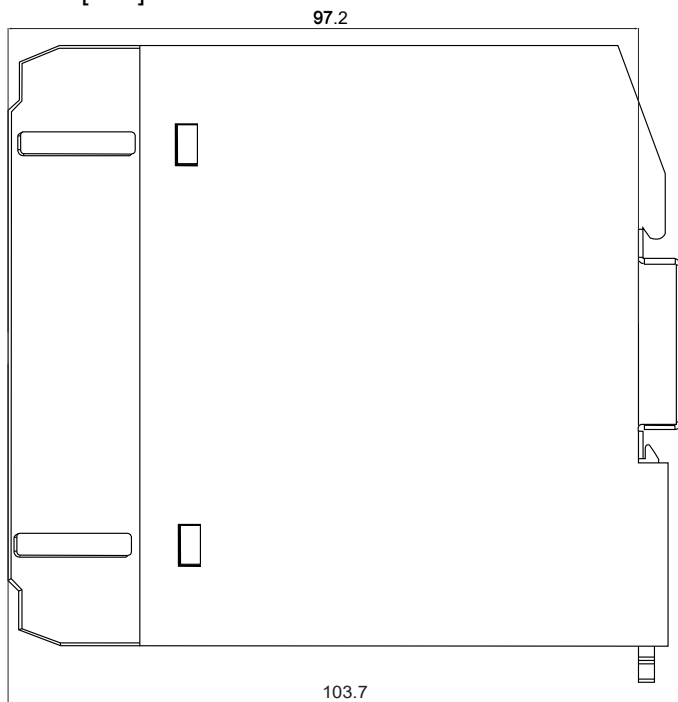

SPDL 30 W

Unit: mm [inch]

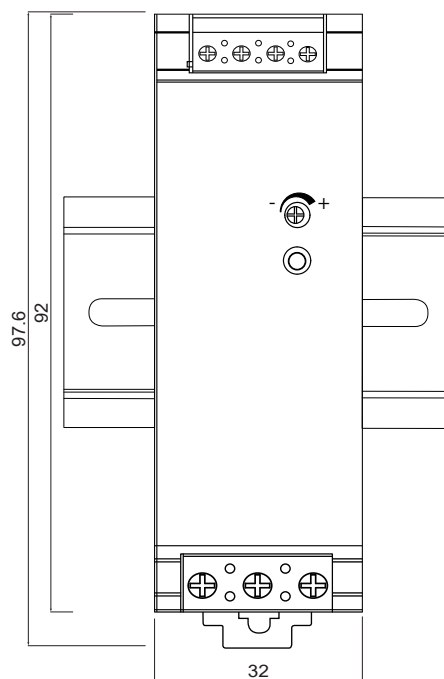
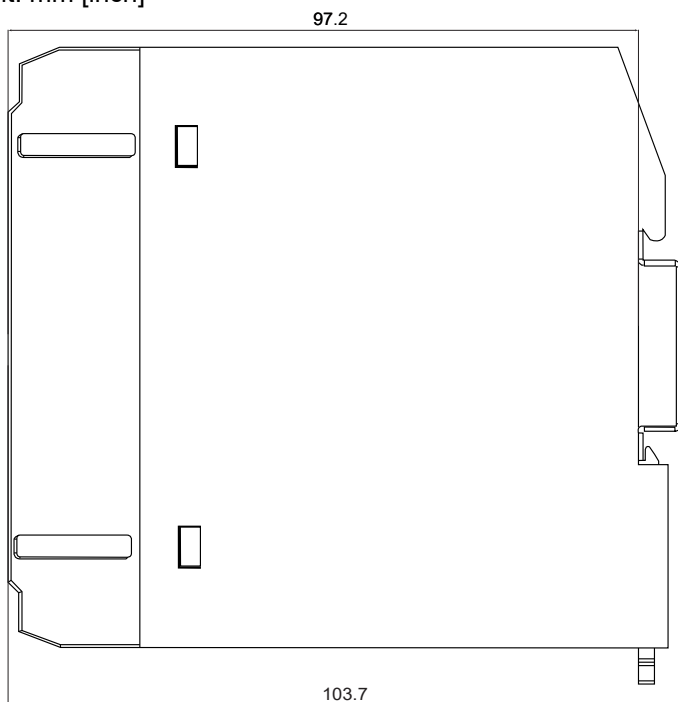

SPDL 60 W
Unit: mm [inch]

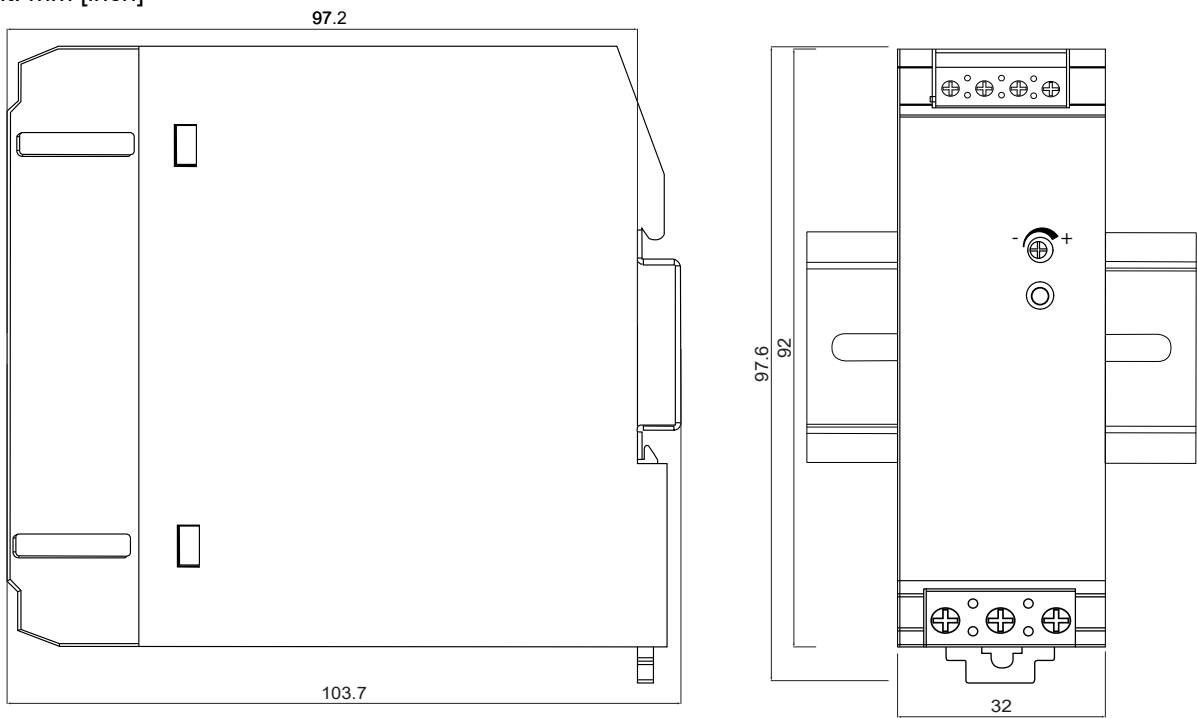

SPDL 75 W
Unit: mm [inch]

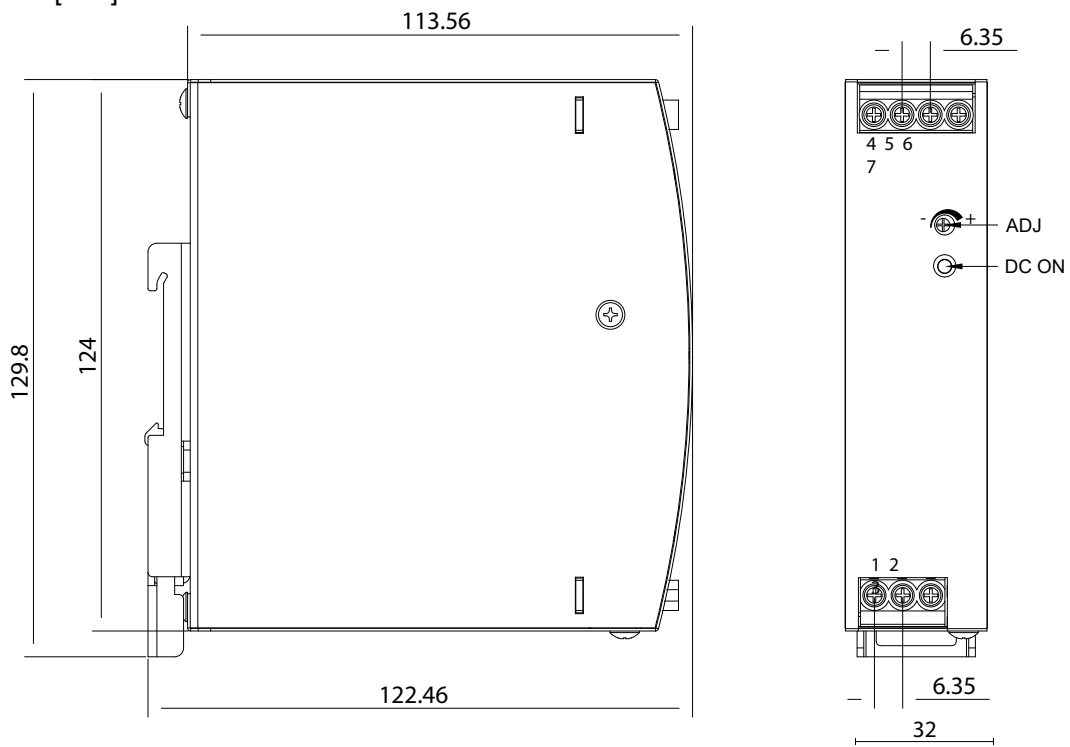

SPDL 120 W
Unit: mm [inch]

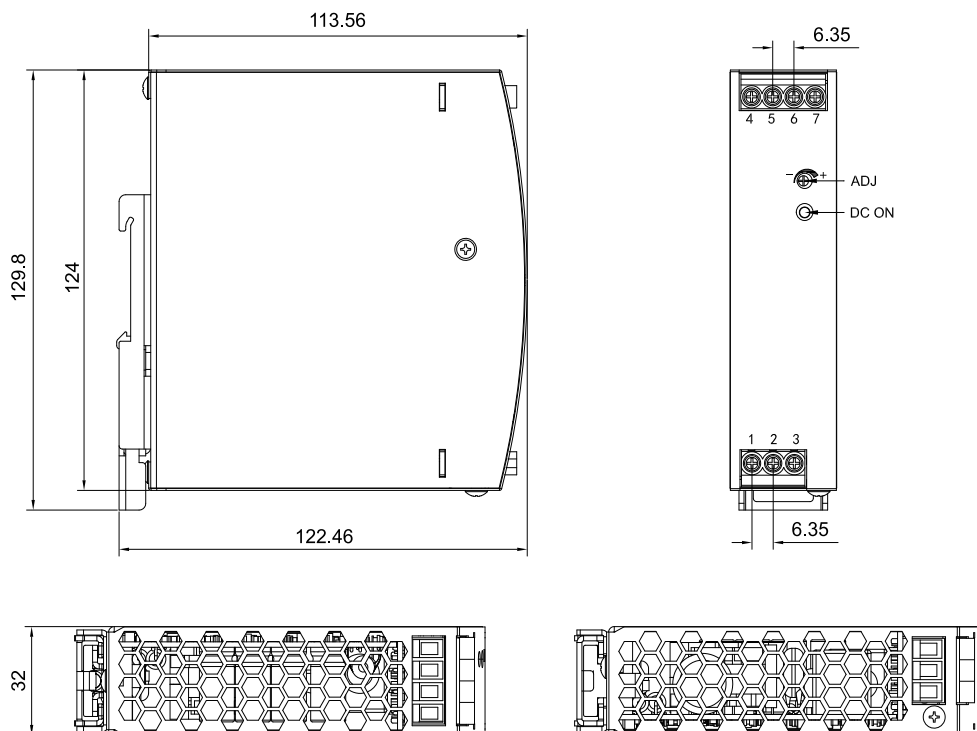

SPDL 240 W R
Unit: mm [inch]

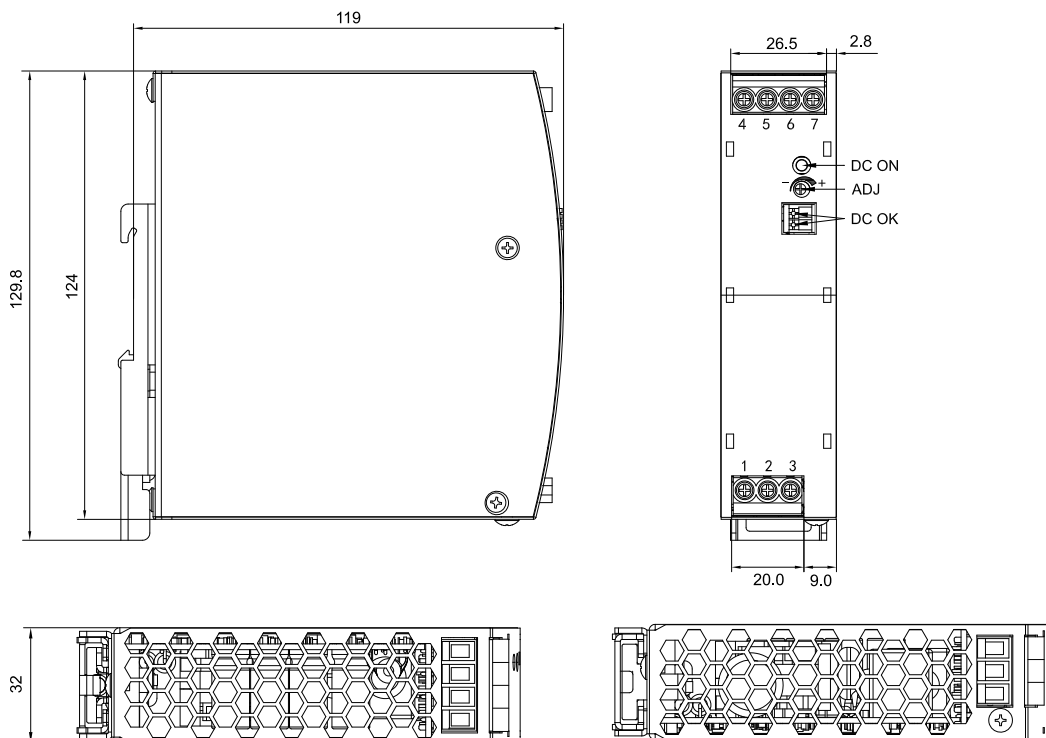

SPDL 480 W
Unit: mm [inch]

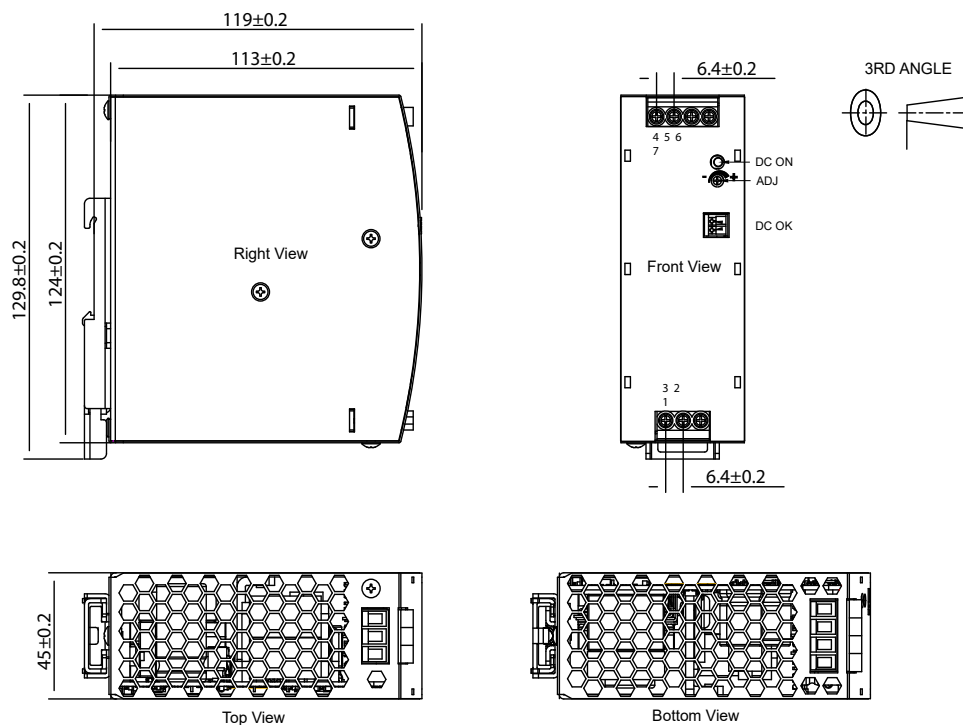

SPDL 480 W R
Unit: mm [inch]

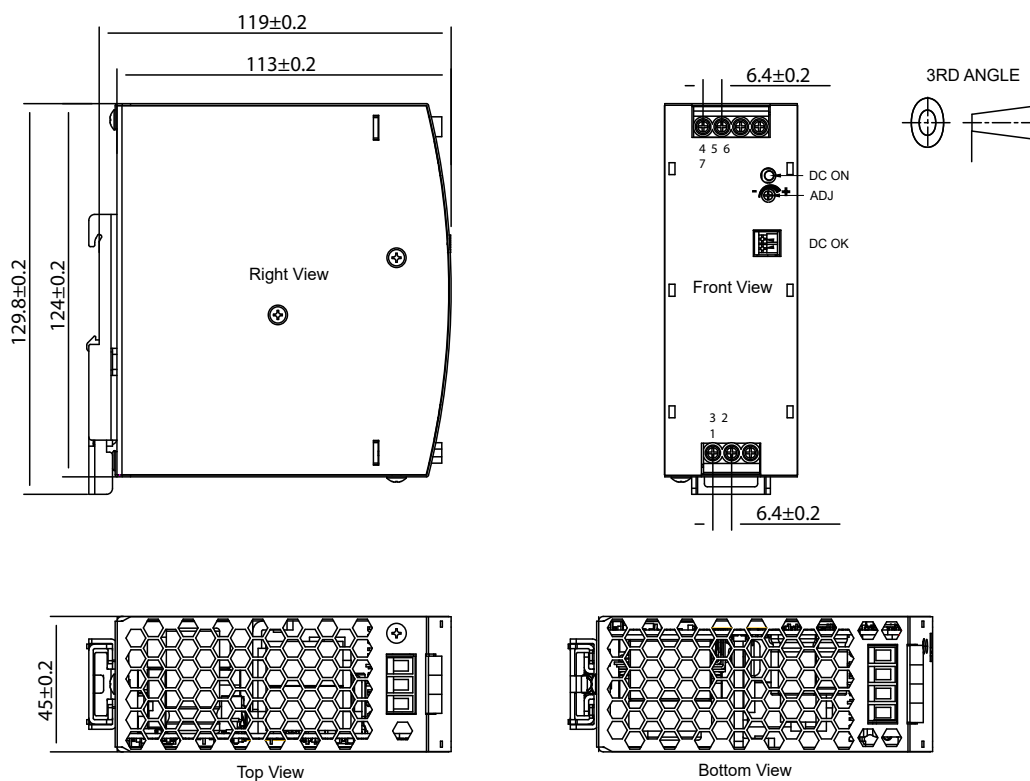

Connection diagram

Terminal markings

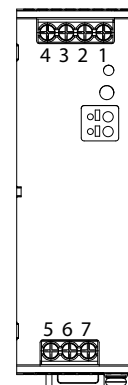

Terminal	Designation	Description
1	-V _o	Negative output terminal
2	-V _o	Negative output terminal
3	+V _o	Positive output terminal
4	+V _o	Positive output terminal
5	AC(L)	Input terminals (phase conductor, no polarity with DC input)
6	AC(N)	Input terminals (neutral conductor, no polarity with DC input)
7	PE	Ground this terminal to minimize high frequency emissions



Environmental

	15 W	30 W	60 W	75 W	120 W	240 W	480 W
Operating temperature	-25°C to 70°C (-13°F to 158°F)			-40°C to 80°C (-40°F to 176°F)		-40°C to 70°C (-40°F to 158°F)	
Storage temperature	-40°C to 85°C (-40°F to 185°F)						
Operating humidity	20 - 90 % RH non-condensing						
Storage humidity	5 - 95 % RH non-condensing					10 - 95 % RH	
Operating altitude	5000 m						
Temperature derating	Refer to derating diagram						
Temperature regulation	± 0.03 % / °C TBH						
Ventilation and cooling	Cooling by free air convection						

Compatibility and conformity

	15 W	30 W	60 W	75 W	120 W	240 W	480 W
Safety standards	UL62368-1			EN62368-1, UL61010			
Approvals							
Conducted (CS) IEC/EN 61000-4-6	3 Vrms (PC A)						10 Vrms (PC A)
Voltage dips and interruptions IEC/EN61000-4-11	0% (PC B) 70% (PC B)						
EMC emission EN55022 EN55024 CE: CISPR32/EN55032 RE: CISPR32/EN55032	CLASS B CLASS B						
Harmonic current	IEC/EN61000-3-2 CLASS A						
EMC immunity	EN61000-4-2, EN61000-4-3, EN61000-4-4, EN61000-4-5, EN61000-4-6, EN61000-4-11						

MCB protection

	15 W	30 W	60 W	75 W	120 W	240 W	480 W	480 W R
Internal fuse of the product	2A slow-blow fuse: SS-5-2A-AP	3.15A slow-blow fuse: SS-5-3.15A-AP		4A slow-blow fuse: SMT T4A 250V		5A slow-blow fuse: SMT1500AP	10A slow-blow fuse: 2010 T10A250V	
Inrush current	50A at 230 VAC		65A at 230 VAC	55A at 230 VAC		30A at 230 VAC		
MCB type and rated value	type D MCB with a rated value of 6A.		type D MCB with a rated value of 10A		type D MCB with a rated value of 16A.	type D MCB with a rated value of 20A		

Insulation

	15 W	30 W	60 W	75 W	120 W	240 W	480 W
Insulation / withstand voltage (input / GND)	1.5 kVAC / < 10 mA			2.0 kVAC / < 10 mA			
Insulation / withstand voltage (input / output)	3.0 kVAC / < 10 mA						
Insulation / withstand voltage (output / GND)	0.5 kVAC / < 10 mA						
Output / DC OK*	30 VDC / 1 A max. or 60 VDC / 0.3 A max. or 30 VAC / 0.3 A max. (resistive load)						
Insulation resistance	> 10 MΩ			>100MΩ			
Overvoltage category	II						
Pollution degree	2						

*Applies only to SPDL 240W

Inputs

	15 W	30 W	60 W	75 W	120 W	240 W	480 W	480 W R
Rated input voltage	100 VDC to 240 VAC							
Input voltage range	90 VAC - 264 VAC (264 VAC max.)					85 VAC - 264 VAC (264 VAC max.)	90 VAC - 264 VAC (264 VAC max.)	85 VAC - 264 VAC (264 VAC max.)
	127 VDC - 370 VDC (370 VDC max.)			120 VDC - 370 VDC (370 VDC max.)			127 VDC - 375 VDC (375 VDC max.)	120 VDC - 375 VDC (375 VDC max.)
AC current (max.) 115 VAC 230 VAC	< 0.5 A	< 0.8 A	< 1.6 A	< 1.45 A < 0.9 A	< 2.25 A < 1.3 A	< 3.0 A < 1.5 A	< 5.5 A < 2.5 A	
Frequency range	47 Hz to 63 Hz							
Inrush current 115 VAC 230 VAC	Cold start - 50 A		Cold start - 65 A (12 V) 50 A (24 V)	Cold start 28 A 55 A		Cold start 15 A 30		



Outputs

	15 W	30 W	60 W	75 W	120 W	240 W	480 W
Output power	15 W	30 W	60 W	75 W	120 W	240 W	480 W
Peak power	-					360 W (3 S)	720 W (3 S)
Voltage accuracy	±1.0 %						
Line regulation	±0.5 %			±0.3 %		±0.5 %	
Load regulation	±1.0 %			±0.5 %		±1.0 %	
Voltage regulation span 12 VDC 24 VDC 48 VDC	12 V to 14 V 24 V to 28 V -		12 V to 14 V 24 V to 28 V -		24 V to 28 V		- 24 V to 28 V 48 V to 55 V
Rated output current 12 VDC 24 VDC 48 VDC	1.25A 0.65 A -	2.5 A 1.25 A -	5 A 2.5 A -	6.3 A 3.2 A -	5 A	10 A	- 24VDC : 20A 48VDC : 10A
Ripple and noise 12 VDC 24 VDC 48 VDC	≤ 120 mV ≤ 120 mV -	≤ 100 mV ≤ 70 mV -	≤ 60 mV ≤ 50 mV -	≤ 100 mV ≤ 100 mV -	≤ 120 mV	≤ 100 mV	- ≤80 mV ≤100 mV
Hold up time 115 Vac 230 Vac	- ≥ 20 ms			≥ 10 ms ≥ 25 ms	≥ 10 ms ≥ 25 ms	≥ 20 ms	≥16 ms
Set-up time 115 Vac 230 Vac	- ≤ 1.5 s			2.5 s 1.2 s	≤ 2.5 s ≤ 1.2 s	≤ 3.0 s ≤ 1.5 s	
Turn-on overshoot	< 5.0 %						
Power boost of rated output current	-					150 % for 3 s	
Mounting space	No requirement for the installation distance						

Performance

Current derating

SPDL12151

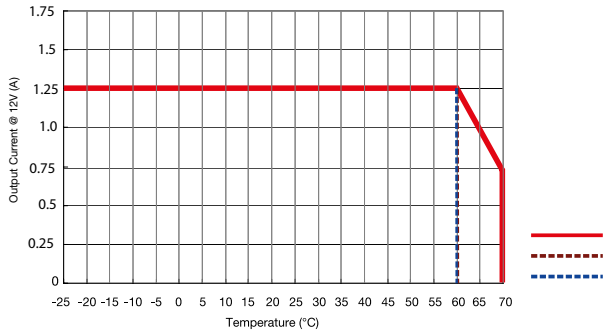

SPDL24151

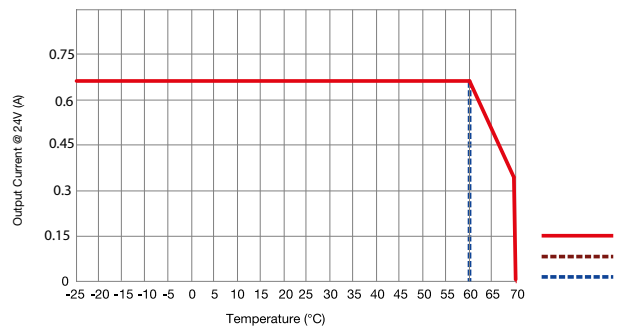

SPDL12301

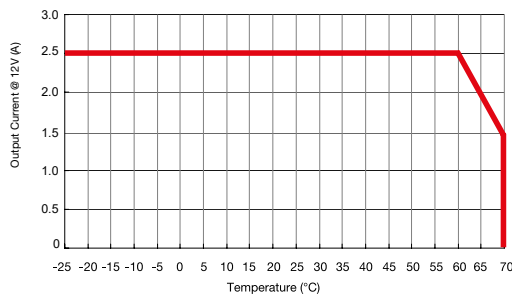

SPDL24301

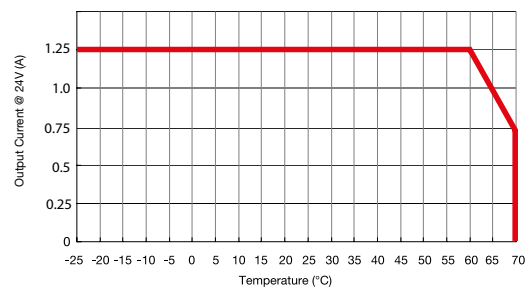

SPDL12601

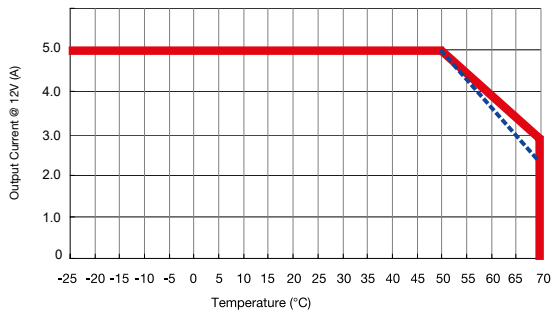

SPDL24601

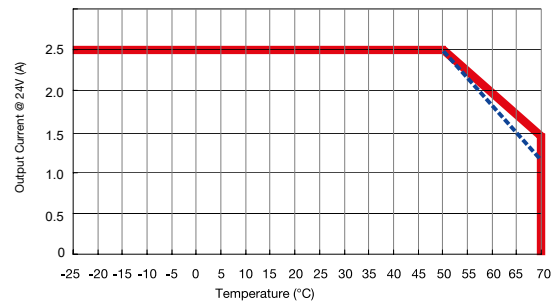

SPDL12751

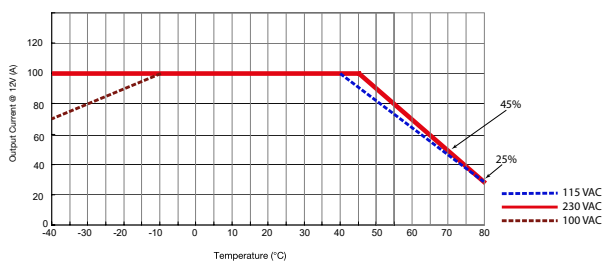

SPDL24751

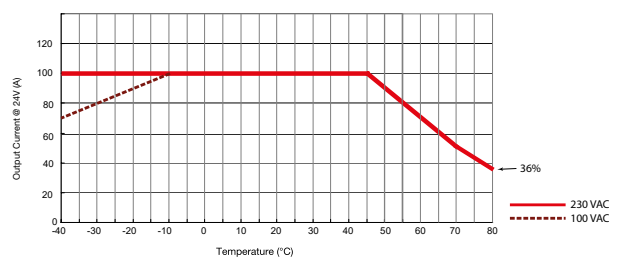

SPDL241201

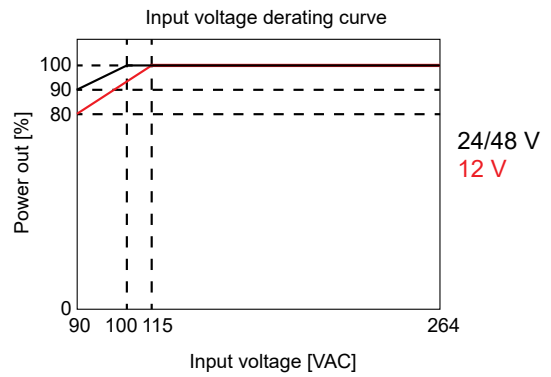
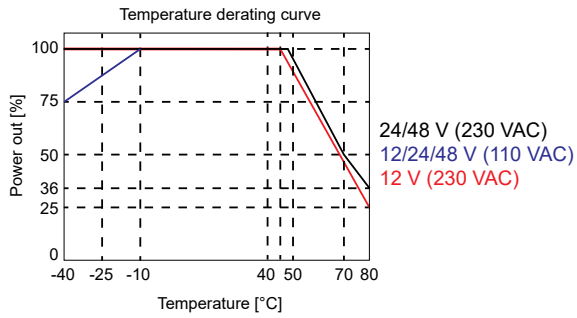

SPDL242401R

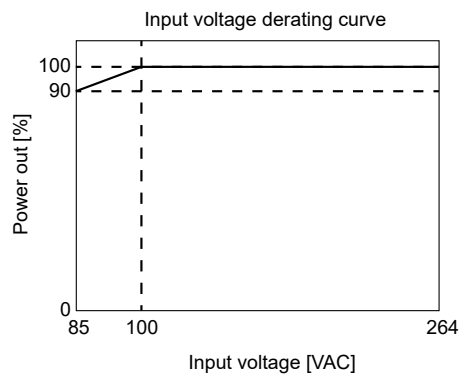
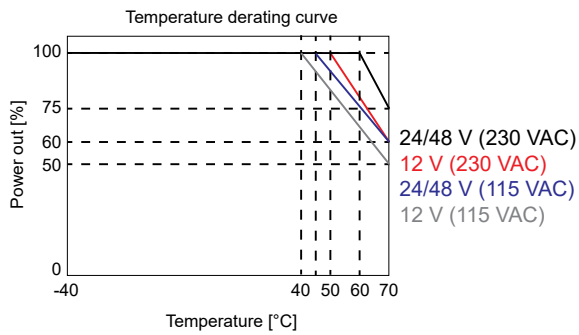

SPDLxx4801

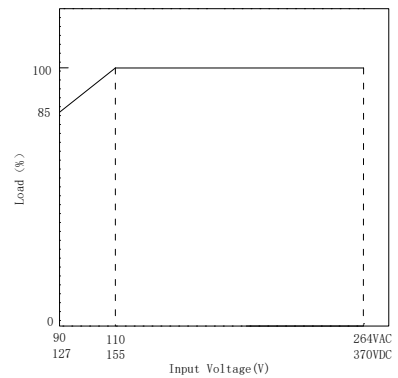
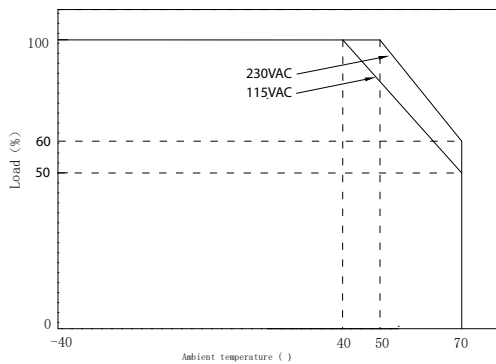

SPDLxx4801R

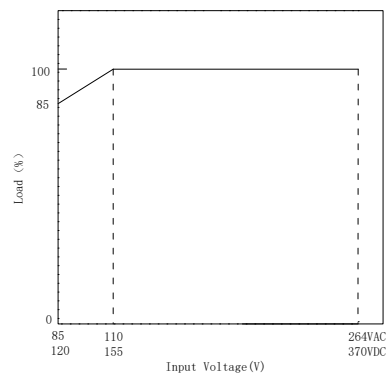
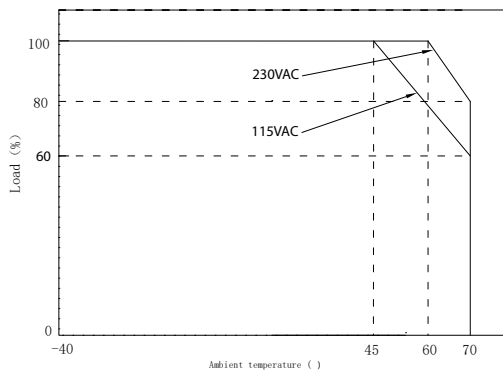

Installation

Ventilation and Cooling	Normal air convection; 25 mm of free space on each side is recommended
--------------------------------	--

Mounting method instruction

A1 is the recommended output current. The output current is a constant of the max value across the full temperature range.

SPDL12151

Mounting A

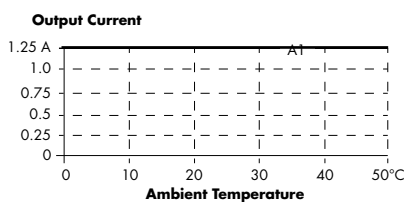
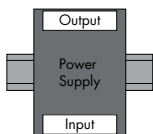

SPDL24151

Mounting A

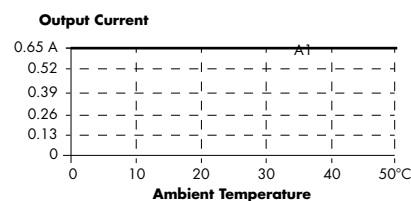
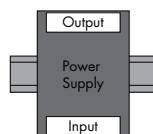

SPDL12301

Mounting A

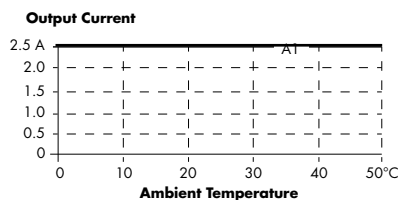
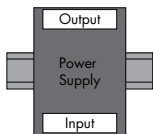

SPDL24301

Mounting A

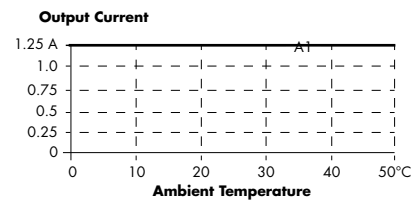
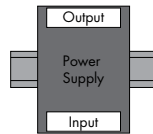

SPDL12601

Mounting A

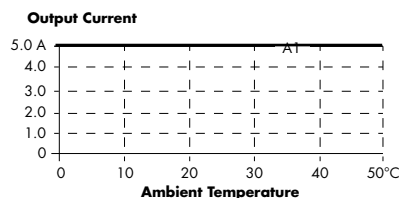
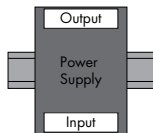

SPDL24601

Mounting A

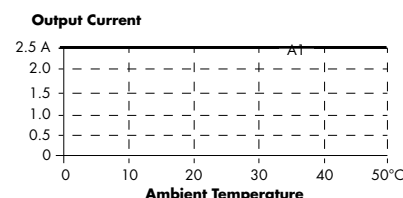
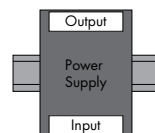

SPDL12751

Mounting A

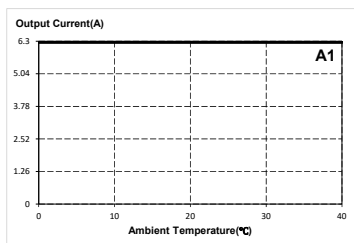
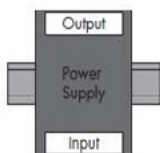

SPDL24751

Mounting A

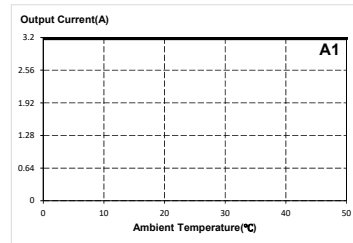
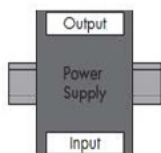

SPDL241201

Mounting A

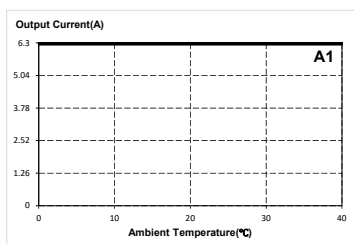
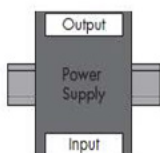

SPDL242401R

Mounting A

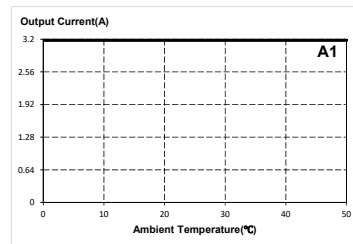
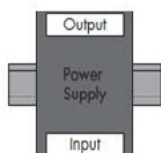

SPDL244801

Mounting A

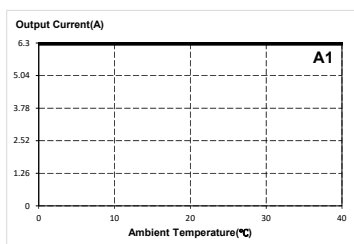
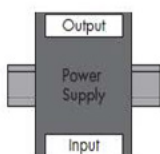

SPDL484801

Mounting A

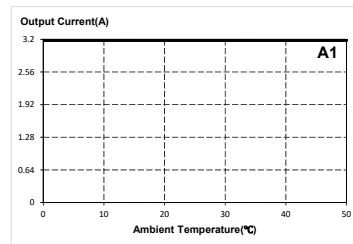
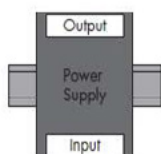

SPDL244801R

Mounting A

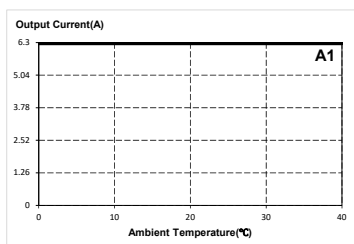
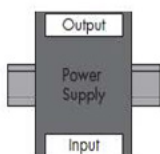

SPDL484801R

Mounting A

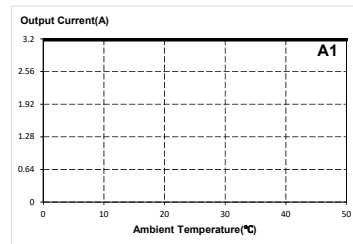
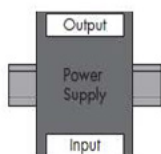

Wiring diagram

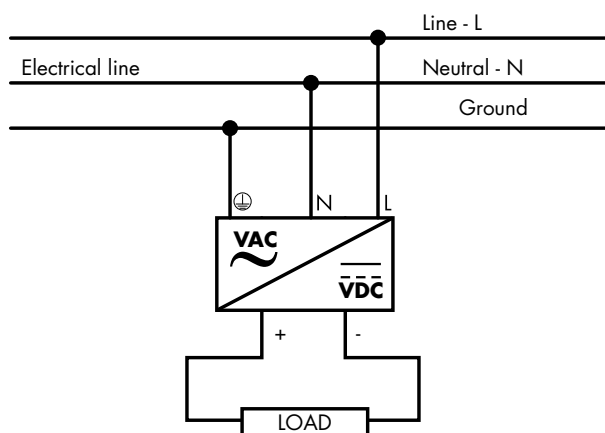

Connection specification

	15 W	30 W	60 W	75 W	120 W	240 W	480 W
Terminal type	Screw terminals blocks			Screw terminals with Phillips screw head			
Screw driver blade	3.5 mm Straight screwdriver			3.5 mm slotted or Phillips			
Tightening torque	0.5 Nm			5 Nm			
Conductor cross section (input terminals)	0.32 - 2.5 mm ² (26 - 12 AWG)			0.14 - 6 mm ² (26 - 10 AWG)		0.14 - 6 mm ² (26 - 10 AWG)	0.5 - 6 mm ² (26 - 10 AWG)
Conductor cross section (PE connection)						4 - 6 mm ² (12 - 10 AWG)	0.5 - 6 mm ² (26 - 10 AWG)
Conductor cross section (output terminals)	-			1.5 - 6 mm ² (16 - 10 AWG)	4 - 6 mm ² (12 - 10 AWG)	0.5 - 6 mm ² (26 - 10 AWG)	
DC OK relay output	-			-		0.25 - 1.5 mm ² (24 - 16 AWG)	0.25 - 1.5 mm ² (26 - 10 AWG)

Block diagram

15 W, 30 W, 60 W, 75 W, 120 W

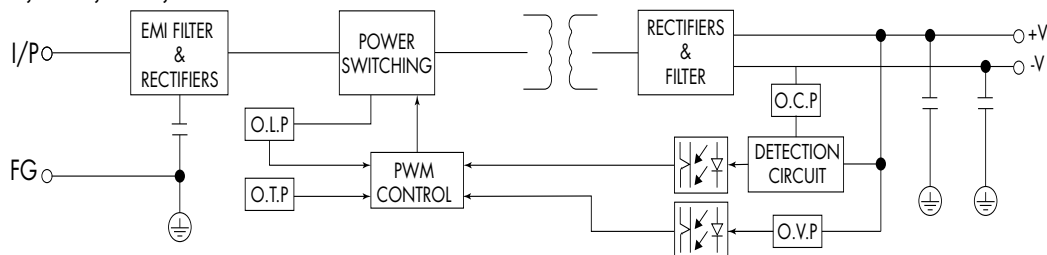

240 W

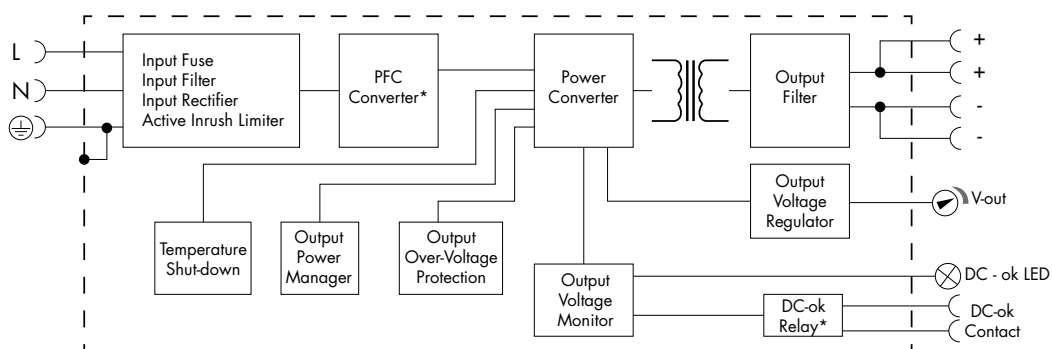

480 W

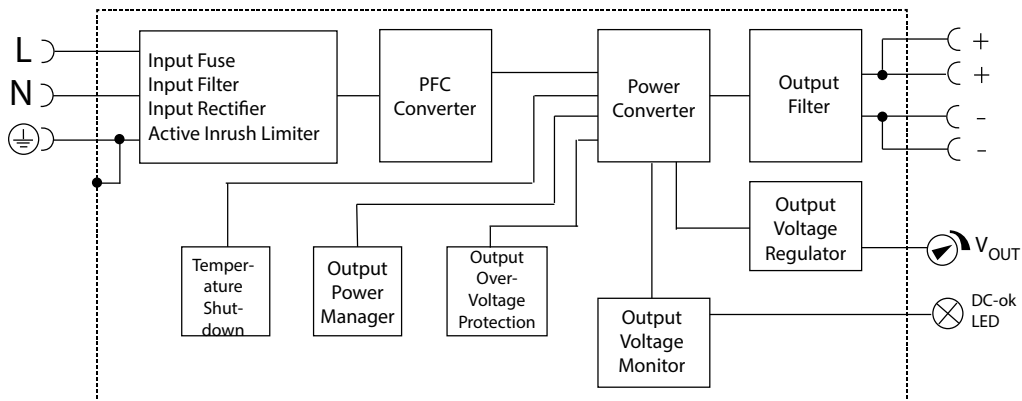

480 W R

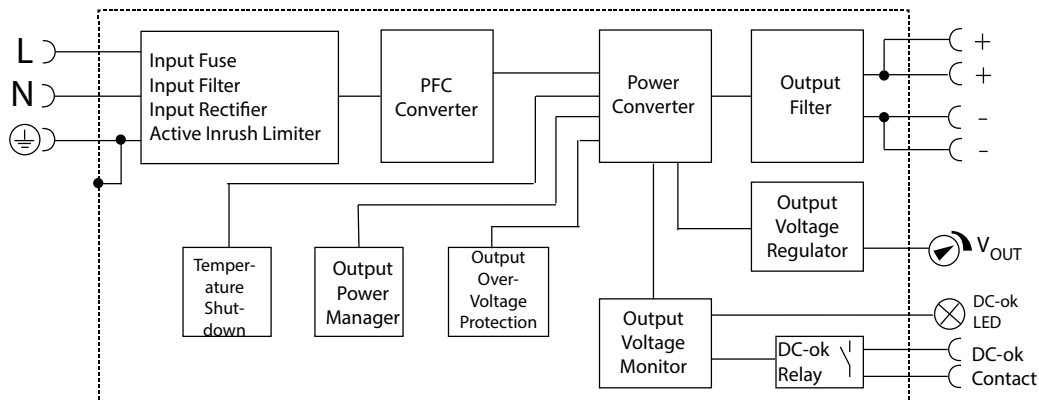

Operating description

Control and protection

	15 W	30 W	60 W	75 W	120 W	240 W	480 W
Overvoltage 12 VDC 24 VDC 48 VDC	15 VDC - 16.8 VDC 28.8 VDC - 31.2 VDC		15.4 VDC - 18 VDC 28.8 VDC - 31.2 VDC	14.5 VDC - 17 VDC 29 VDC - 33 VDC	- 29 VDC - 33 VDC		29 VDC - 33 VDC 56 VDC - 63 VDC
	Constant voltage, auto recovery			Shut down Re-power ON	Shut down o/p voltage, re-power on to recover	Shut down o/p voltage, auto recovery	Shut down Re- power ON
Overload 12 VDC 24 VDC	1.5 - 2.0 A 0.7 - 1.0 A	3.0 - 4.0 A 1.5 - 2.5 A	6.0 - 7.5 A 3.0 - 4.0 A	105 - 150% of rated output power	105 - 150% Io, self-recovery	110% - 200% Io, hiccup, self-recovery	110 - 150% Io,
	Hiccup mode, auto recovery						
Short circuit	Long-term mode, auto recovery						
Overtem- perature	No protection			Shut down o/p voltage, re-power on to recover		Self-recovery	



COPYRIGHT ©2025
Content subject to change.
Download the PDF: <https://gavazziautomation.com>