



FEATURES

- Supports DALI-2 + PUSH DIM Control + NFC
- Inbuilt CLO Function
- Compliance to DALI-2 PART 101, 102, 207, 251, 252, 253
- DALI Function setting through NFC
 - a. O/P Current setting in step of 1mA.
 - b. Set Min-Max level.
 - c. Set system failure level.
 - d. Set power on level.
 - e. Set address manually 0 to 63.
 - f. Create Groups manually 1 to 16.
 - g. Set Fade time.
 - h. Set fade rate.
 - i. change dimming curve manually Linear OR Logarithmic.
 - j. Set Scenes manually.
- SELV CLASS II Design.
- Dimming range 0.1% to 100%.
- High PF, Low THD, High Efficiency.
- CE, Flicker free.
- Nominal Life 100,000hrs.
- Suitable for indoor use only.

INTERFACE

- DALI-2 DT6
- PUSH-DIM

FUNCTIONS

- Memory function
- Suitable for emergency lighting (EL)
- Protection features
(short circuit, open circuit, over load, no load, hot plug-in)

SUITABLE FOR LIGHTS

- Suitable for Linear lights, tri-proof lights, working lights and other linear or ultra thin lights.

TYPICAL APPLICATIONS

- LED Indoor lighting.
- LED Office lighting.
- LED Commercial lighting.

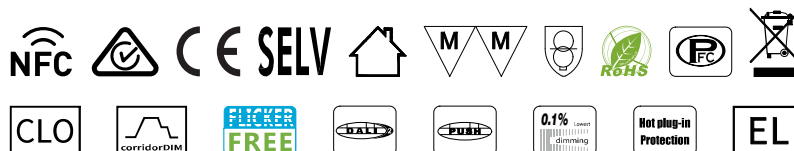

- Dimmable Constant Current 1-Channel LED Driver with DALI DT6
- Dimming range 0.1 to 100%
- NFC Programable
- DALI PART 101, 102, 207, 251, 252 & 253
- Inbuilt CLO Function
- Output Wattage : 10W Max
- Output voltage range of 12-42Vdc
- Output Current: 100 - 450mA
- Flicker-free Output ripple current <5% LF

- Application**
- LED indoor lighting
 - LED office lighting
 - LED architectural lighting
 - LED panel lamp lighting

General Specifications

Rated Input Voltage	240VAC ±10%, 50/60Hz	
Operating Input Voltage Range	196-264VAC, 50/60Hz	
Input Current Max.	0.1 @ 230Vac	
Input Power	14.5W	
Power Factor	>0.93 @ 230Vac Full Load	
THD	<15% @ 230Vac Full Load	
Efficiency (Typical)	70%	
Driver Type	Constant Current DALI-2	
Output Current	100mA to 450mA ±3% (Current setting through NFC, with step of 0.1mA)	
	Default Current setting 250mA	
	*Refer Output Voltage vs Output current graph	
Output Voltage Range	12-42Vdc	
Dimming Controller Type	DALI-2 (Amplitude/CCR dimming)	
Output Power	10W	
Output ripple current	<5%, Flicker Free at 100Hz	
Number of Output Channels	1 Channel	
Output Type	Class II	
Ambient Operating Temperature Range	-20°C to 45°C	
Max. Case Temperature	85°C	
Input Surge Protection	1KV	
Protections	Input Over Current	: Non Resettable (Fuse)
	Output Short Circuit	: Auto Recovery (HICCUP Mode)
	Output Open Circuit	: Auto Recovery (HICCUP Mode)
	Output Overload	: YES
	Over Temperature	: Auto Recovery (HICCUP Mode)
Standards	EN55015, EN61000-3-2, EN61000-3-3	
	EN61547, EN61000-4-2,3,4,5,6,8,11	
	EN61347-1, EN61347-2-13	
	IEEE1789	
Withstand Voltage	I/P-O/P:3750Vac	
Leakage Current	<0.5mA @ 240Vac	
Isolation resistance	I/P-O/P:100MΩ / 500Vdc / 25°C / 70% RH	
Life	50,000 Hours @ 80°C	
Approvals / Class	SELV Equivalent	
Warranty	5 Years at Tc 80°C	
Weight	0.07 Kg	

Note : Suitable for indoor application only

Fulham extends a limited warranty only to the original purchaser or to the first user for a period of **05 years @ Tc 80°C** from the date of manufacture when properly installed and operated under normal conditions of use. For complete terms and conditions, please reference the Fulham Product Catalog (www.fulham.com). Due to a program of continuous improvement, Fulham reserves the right to make modifications or variations in design or construction to the equipment described. © Fulham Company Limited, All Rights Reserved.

Output Voltage Vs Output Current

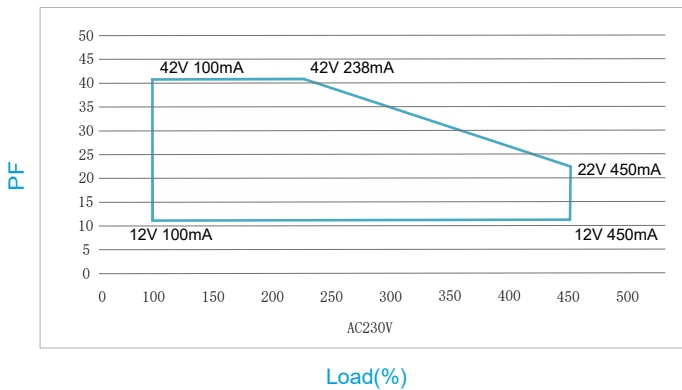

THD vs. Load

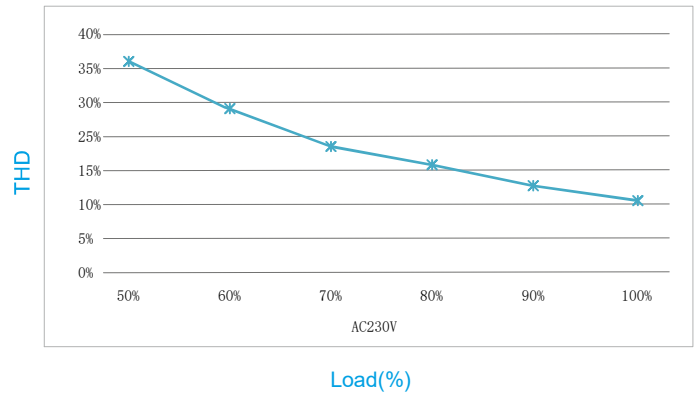

* Default Current - 250mA

Power factor vs. Load

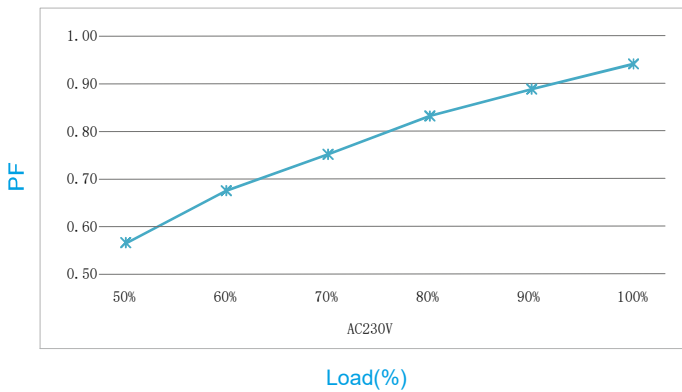

Efficiency vs load

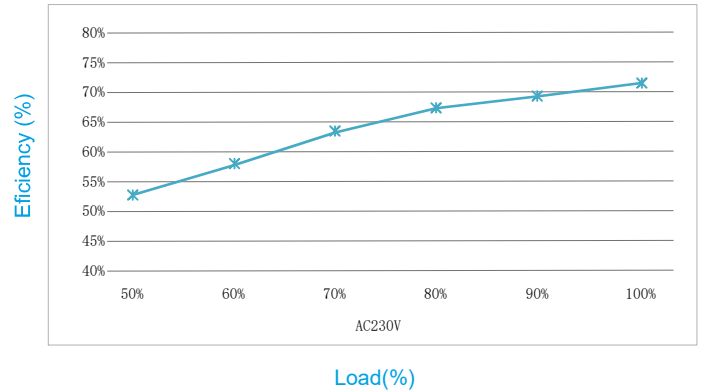

Life vs. Tc curve

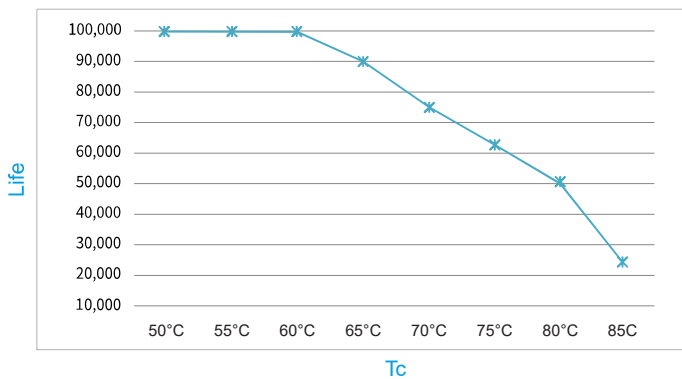

Dimming Curve

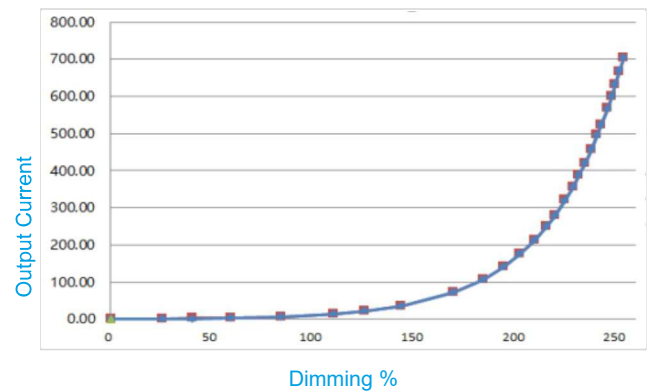

Remarks: The default is logarithmic dimming curve.

Fulham extends a limited warranty only to the original purchaser or to the first user for a period of **05 years @ Tc 80°C** from the date of manufacture when properly installed and operated under normal conditions of use. For complete terms and conditions, please reference the Fulham Product Catalog (www.fulham.com). Due to a program of continuous improvement, Fulham reserves the right to make modifications or variations in design or construction to the equipment described. © Fulham Company Limited, All Rights Reserved.

DALI dimming application

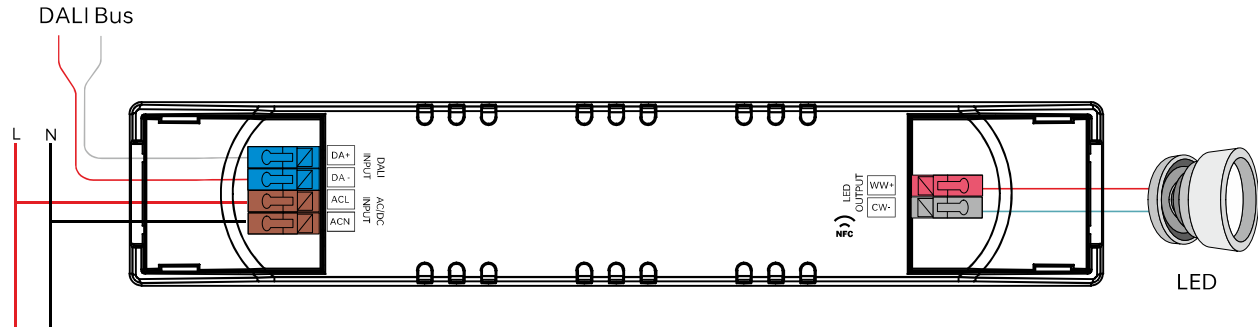

Activating DALI control mode

- After installation according to the wiring diagram of DALI control application, the driver will automatically switch to the DALI control mode after receiving any DALI command.

PUSH dimm

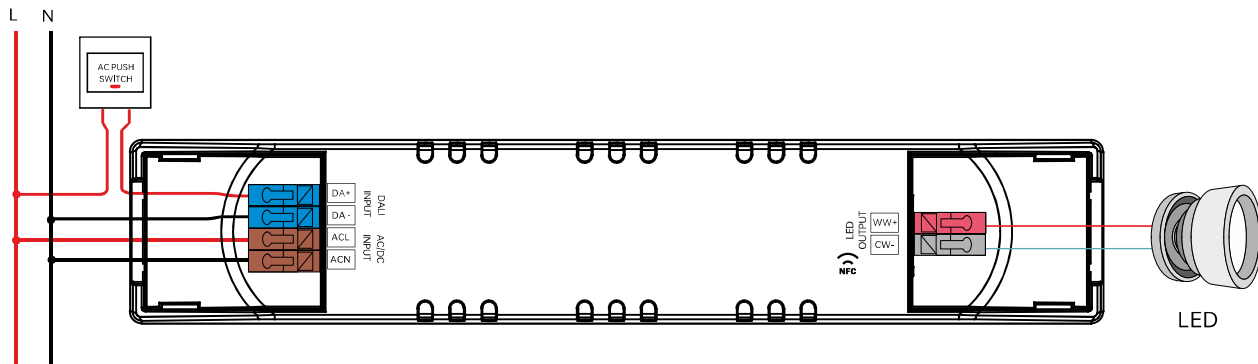

Using PUSH DIM controls:

After installation according to the wiring diagram of PUSH-DIM control application,

1. Press PUSH switch it will increase the Brightness, release the witch and again press PUSH switch it will Reduce the Brightness.

Multiple lights synchronize control operation

method 1: Step 1: long press the PUSH-DIM switch, confirm each light is on.

Step 2: short press the PUSH-DIM switch, confirm each light is off.

Step 3: long press the PUSH-DIM switch, confirm each light is from darkest to brightest and all the lights are synchronous.

method 2: - Long press the PUSH-DIM dimming switch for more than 15s, all drivers will output 100% brightness and the color temperature is natural white (middle of color temperature range).

Remarks:

- Standard DALI control line voltage range: 9.5V to 22.5V, type 16V.
- The two DALI control lines polarity-reversible.
- Max. 64 DALI drivers per DALI control line.
- The maximum distance length of the DALI control line is 300m at 2x1.5mm².
- DALI bus can be wired together with any mains voltage cables, but separate wiring is recommended.

Wiring distance vs cable size

Cable size	Distance
2x0.50mm ²	max.100m
2x0.75mm ²	max.150m
2x1.00mm ²	max.200m
≥2x1.50mm ²	max.300m

Fulham extends a limited warranty only to the original purchaser or to the first user for a period of **05 years @ Tc 80°C** from the date of manufacture when properly installed and operated under normal conditions of use. For complete terms and conditions, please reference the Fulham Product Catalog (www.fulham.com). Due to a program of continuous improvement, Fulham reserves the right to make modifications or variations in design or construction to the equipment described. © Fulham Company Limited, All Rights Reserved.

Mechanical Data :

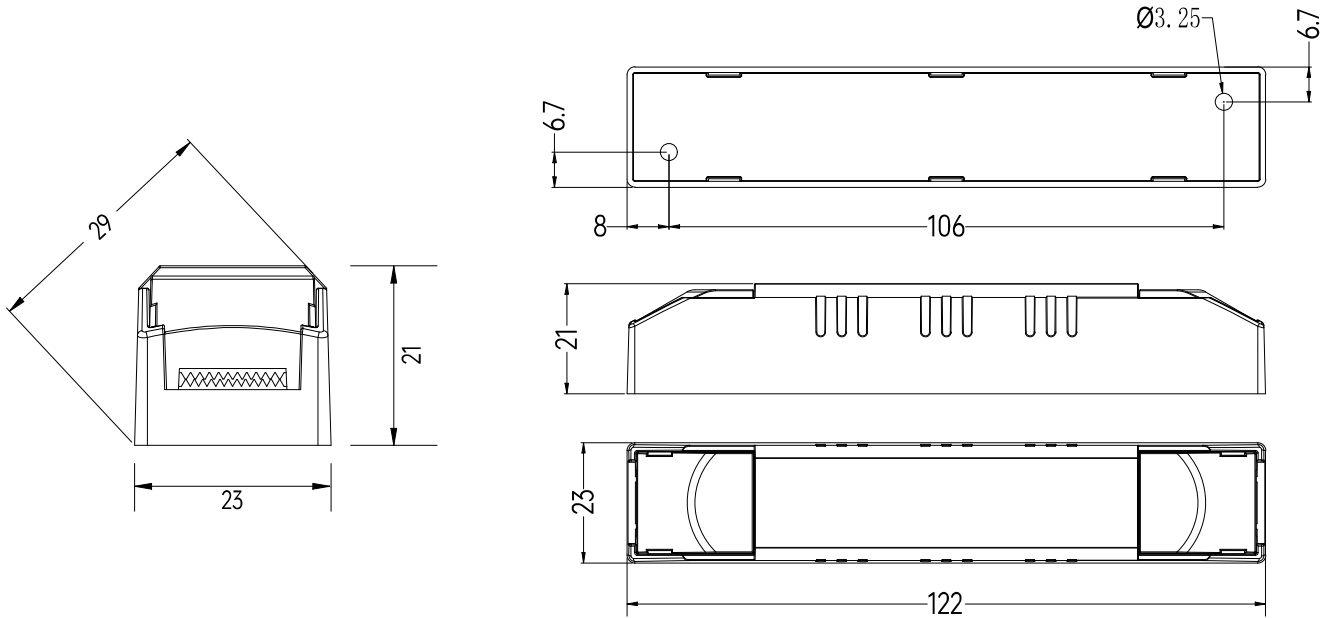

Note : All Dimensions are in mm.

Tolerance=±0.5mm

Packaging

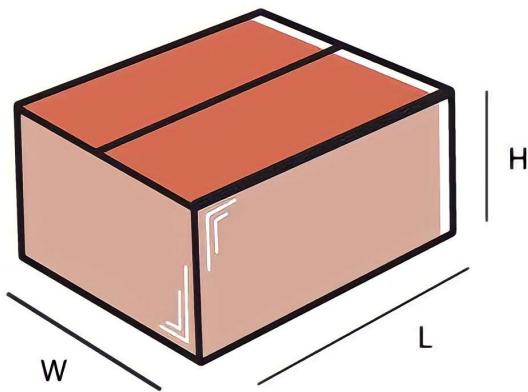

Master carton

OUTER DIMENSION		
L	W	H
270mm	260mm	145mm
Net Weight	Gross Weight	QUANTITY
7.00 kg	7.70 kg	100 pc.

Installation Instructions:

Connect Wires as per details given on the Driver Screen. Keep proper ventilation around the LED Driver and do not stack any object on it. Also a 10-15 cm clearance must be kept when the adjacent device is a heat source. Do not exceed the declared Hot spot temperature($T_c \text{ max}$) under any circumstances.

Fulham extends a limited warranty only to the original purchaser or to the first user for a period of **05 years @ T_c 80°C** from the date of manufacture when properly installed and operated under normal conditions of use. For complete terms and conditions, please reference the Fulham Product Catalog (www.fulham.com). Due to a program of continuous improvement, Fulham reserves the right to make modifications or variations in design or construction to the equipment described. © Fulham Company Limited, All Rights Reserved.