

## Power Inductors

Power Choke Coil (Automotive Grade)

**PCC-M0648M-LE** series

**PCC-M0748M-LE** series

High heat resistance and high reliability using metal composite core (MC)

Industrial property : Patents 3 (Registered 2 / Pending 1)

### Features

- Low loss (Low DC resistance)
- High heat resistance : Operation up to 150 °C including self-heating. (180 °C short time\*)  
\* Please contact for possible to use over 150 °C condition. Temperature up to 180 °C may possibly be used.
- SMD type
- High-reliability : High vibration resistance as result of newly developed integral construction ; under severe reliability conditions of automotive and other strenuous applications
- High bias current : Excellent inductance stability using ferrous alloy magnetic material
- Temp. stability : Excellent inductance stability over broad temp. range
- Low audible (buzz) noise : A gapless structure achieved with metal composite core
- High efficiency : Low DC resistance of winding and low eddy-current loss of the core
- Shielded construction
- AEC-Q200 compliant
- RoHS compliant

### Recommended applications

- Noise filter for various drive circuitry requiring high temp. operation and peak current handling capability
- Boost-Converter, Buck-Converter DC/DC

### Standard packing quantity (Minimum quantity/Packing unit)

- 1,000 pcs/box (2 reel)

### Explanation of part numbers

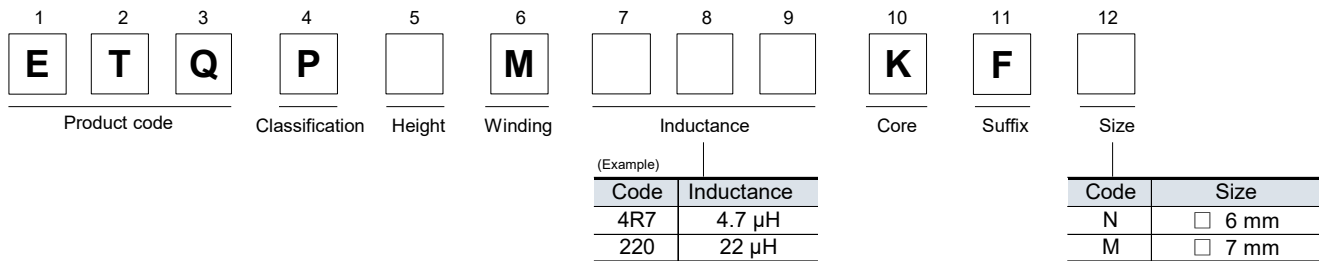

### Temperature rating

Operating temperature range		Tc : -40 °C to +150 °C (Including self-temperature rise)
Storage condition	After PWB mounting	
	Before PWB mounting	Ta : -5 °C to +35 °C 85%RH max.

## 1. PCC-M0648M-LE series (ETQP4M□□□KFN)

### Standard parts

Part No.	Inductance <sup>*1</sup>		DCR (at 20 °C) (mΩ)		Rated current (A) Typ.		Vibration resistance (G)  *5	MSL  *6	Series [Size L×W×H] (mm)
	L0 (μH)	Tolerance (%)	Typ. (max.)	Tolerance (%)	$\Delta T = 40 \text{ K}^{*2}$ ( ) <sup>*3</sup>	$\Delta L =$ -30 % <sup>*4</sup>			
ETQP4M3R3KFN	3.3	±20	13.1 [14.41]	±10	9.2 [7.2]	12.2	4.4	1	PCC-M0648M-LE [6.0×6.4×4.8]
ETQP4M4R7KFN	4.7		20.7 [22.77]		7.3 [5.7]	10.2			
▲ETQP4M5R6KFN	(5.6)		(28 [31])		(6.3 [4.9])	(10)			
ETQP4M6R8KFN	6.8		32.1 [35.31]		5.9 [4.6]	9.9			
▲ETQP4M8R2KFN	(8.2)		(35 [39])		(5.6 [4.4])	(9.5)			
ETQP4M100KFN	10.0		40.4 [44.44]		5.2 [4.1]	9.1			
ETQP4M150KFN	15.0		63.8 [70.18]		4.2 [3.3]	6.9			
ETQP4M220KFN	22.0		113.0 [124.3]		3.1 [2.4]	4.1			
▲ETQP4M330KFN	(33)		(144 [158])		(2.8 [2.2])	(3.7)			
▲ETQP4M470KFN	(47)		(190 [209])		(2.4 [1.9])	(3.3)			

\*1: Measured at 100 kHz

▲ This spec may change because these are under development

\*2: The proved current value for making the overall temperature rise of 40K, when mounted on a multi-layer board with high-heat dissipation (heat dissipation constant 6.4 x 6.0 x 4.8 mm : approx. 36 K/W).

\*3: The proved current value for making the overall temperature rise of 40K, when mounted on a 4-layer circuit board of FR4 t=1.6 mm and DC current is applied.

\*4: Saturation rated current : DC current which causes L(0) drop -30 %.

\*5: Vibration resistance conditions : Amplitude: 5 mm or less, sweep speed: 1 oct / min, frequency 5-2000 Hz, 3 directions/2 hours each, total 6 hours

\*6: The solderability is guaranteed for 1 year only. The product out of expiration date shall not be used.

◆ Within a suitable application, the part's temperature depends on circuit design and certain heat dissipation conditions. This should be double checked in a worst case operation mode. In normal case, the max. standard operating temperature of +150°C should not be exceeded. Please contact for possible to use over 150 °C condition. Temperature up to 180 °C may possibly be used.

### Performance characteristics (Reference①)

#### ● Inductance vs DC Current

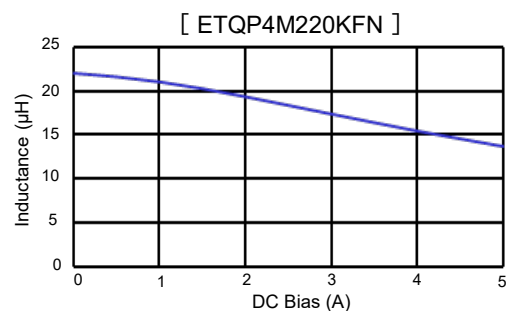
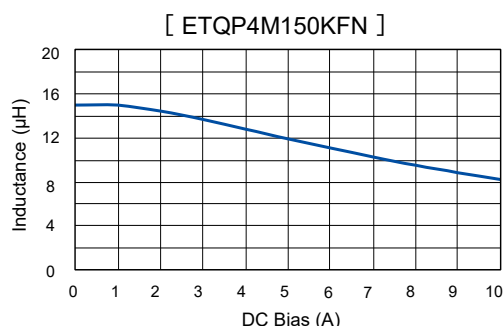
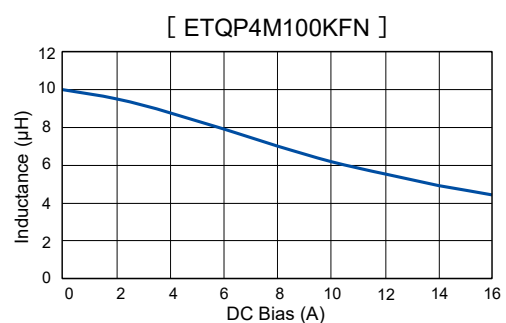
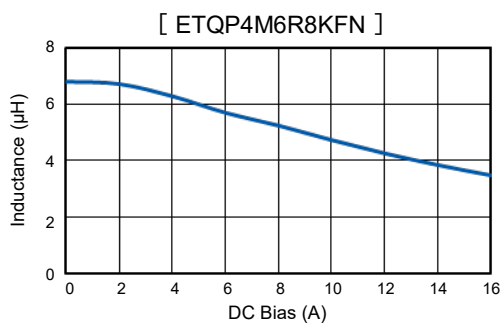
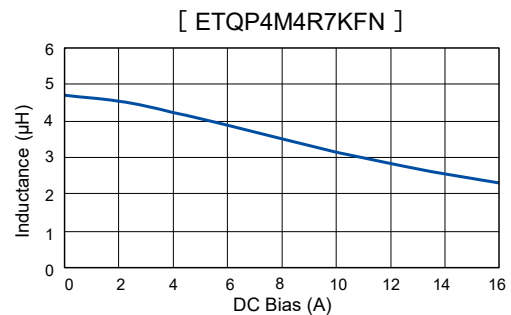
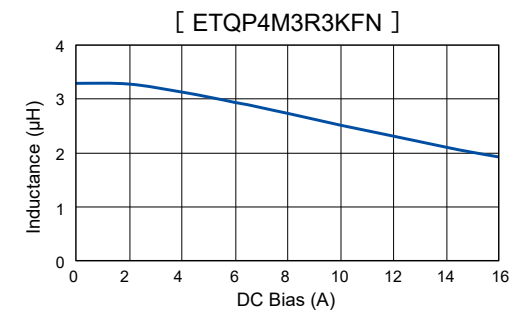

Performance characteristics (Reference①)

● Inductance vs DC Current

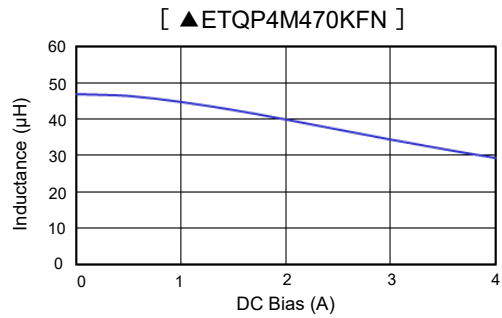
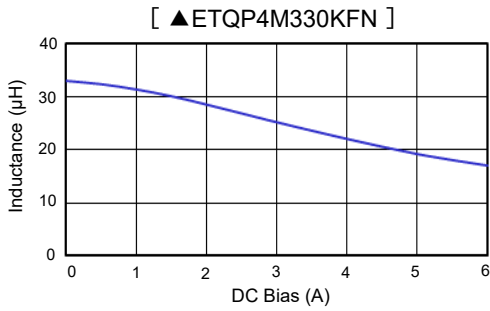

▲ This spec may change because these are under development

Performance characteristics (Reference②)

● Case Temperature vs DC Current

— PWB condition A : Four-layer PWB (1.6 mm FR4).<sup>\*3</sup>

- - - PWB condition B : Multilayer PWB with high heat dissipation performance.<sup>\*2</sup>

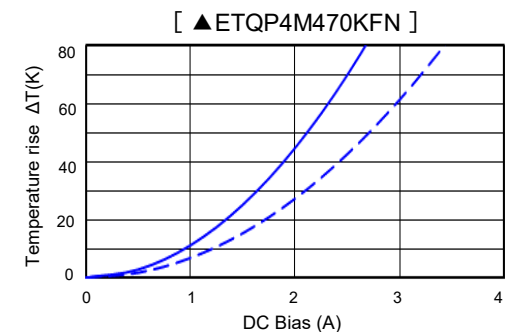
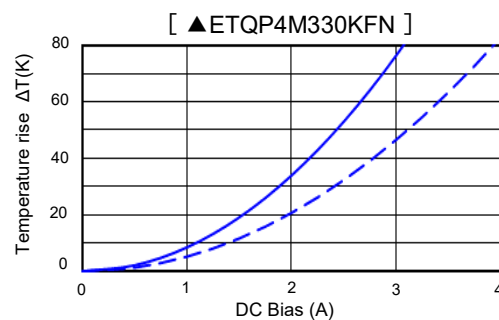
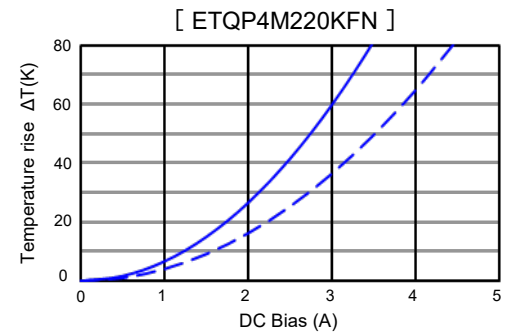
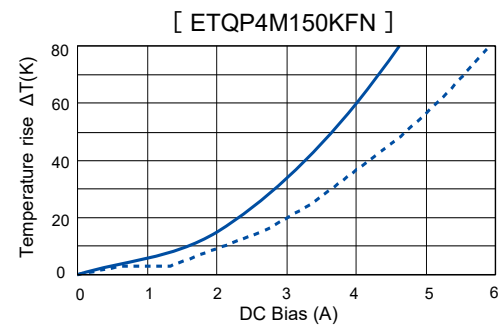
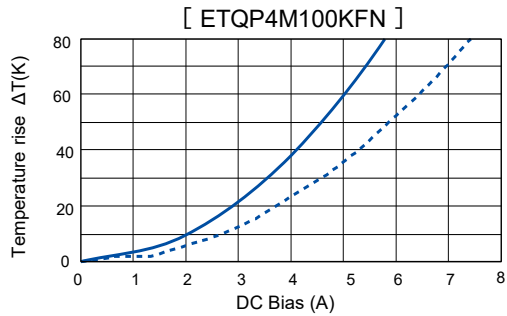
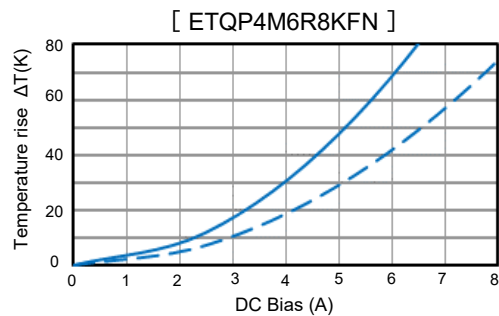
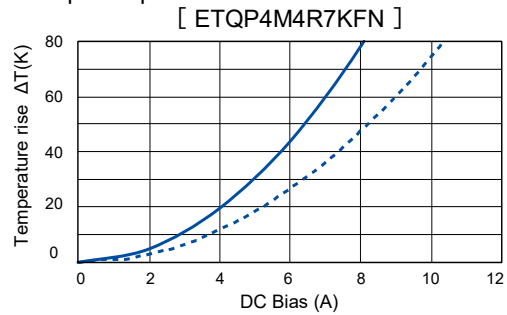
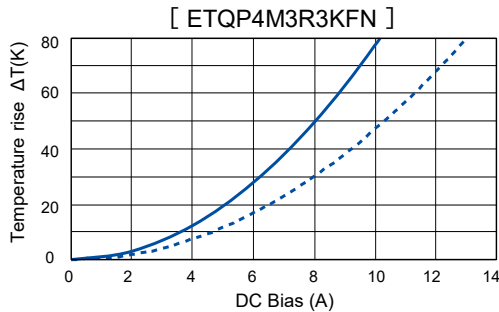

▲ This spec may change because these are under development

## 2. PCC-M0748M-LE series (ETQP4M□□□KFM)

### Standard parts

Part No.	Inductance <sup>*1</sup>		DCR (at 20 °C) (mΩ)		Rated current (A) Typ.		Vibration resistance (G)	MSL	Series [Size L×W×H] (mm)
	L0 (μH)	Tolerance (%)	Typ. (max.)	Tolerance (%)	ΔT= 40 K <sup>*2</sup> ( ) <sup>*3</sup>	ΔL= -30 % <sup>*4</sup>			
ETQP4MR47KFM	0.47	±20	3.3 [3.63]	±10	19.8 [14.7]	29.8	4.4	1	PCC-M0748M-LE [7.0×7.4×4.8]
<b>NEW</b> ETQP4M1R2KFM	1.2		6.6 [7.26]		14.0 [10.4]	20.7			
<b>NEW</b> ETQP4M1R5KFM	1.5		8.1 [8.91]		12.6 [9.3]	18.2			
<b>NEW</b> ETQP4M2R2KFM	2.2		9.5 [10.45]		11.7 [8.6]	16.1			
ETQP4M4R7KFM	4.7		16.8 [18.48]		8.8 [6.5]	10.6			
▲ETQP4M8R2KFM	(8.2)		(31 [34])		(6.5 [4.8])	(9.8)			
ETQP4M100KFM	10.0		36.0 [39.60]		6.0 [4.5]	9.5			
ETQP4M150KFM	15.0		60.7 [66.77]		4.6 [3.4]	7.2			
ETQP4M220KFM	22.0		84.1 [92.51]		3.9 [2.9]	5.2			
ETQP4M330KFM	33.0		115.0 [126.5]		3.4 [2.5]	4.2			
ETQP4M470KFM	47.0		148.6 [163.46]		2.9 [2.2]	3.7			

\*1: Measured at 100 kHz

▲ This spec may change because these are under development

\*2: The proved current value for making the overall temperature rise of 40K, when mounted on a multi-layer board with high-heat dissipation (heat dissipation constant 7.4 x 7.0 x 4.8 mm : approx. 31 K/W).

\*3: The proved current value for making the overall temperature rise of 40K, when mounted on a 4-layer circuit board of FR4 t=1.6 mm and DC current is applied.

\*4: Saturation rated current : DC current which causes L(0) drop -30 %.

\*5: Vibration resistance conditions : Amplitude: 5 mm or less, sweep speed: 1 oct / min, frequency 5-2000 Hz, 3 directions/2 hours each, total 6 hours

\*6: The solderability is guaranteed for 1 year only. The product out of expiration date shall not be used.

◆ Within a suitable application, the part's temperature depends on circuit design and certain heat dissipation conditions. This should be double checked in a worst case operation mode. In normal case, the max. standard operating temperature of +150°C should not be exceeded. Please contact for possible to use over 150 °C condition. Temperature up to 180 °C may possibly be used

### Performance characteristics (Reference①)

#### ● Inductance vs DC Current

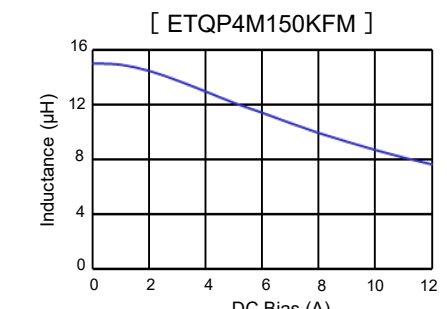
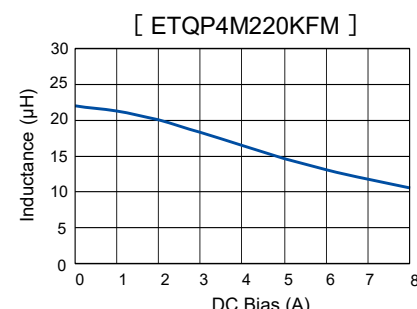
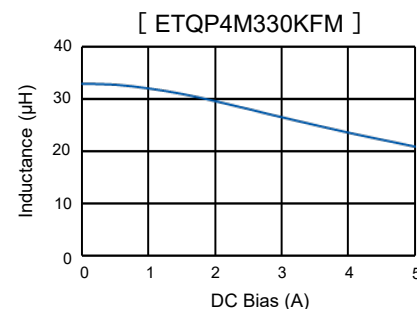
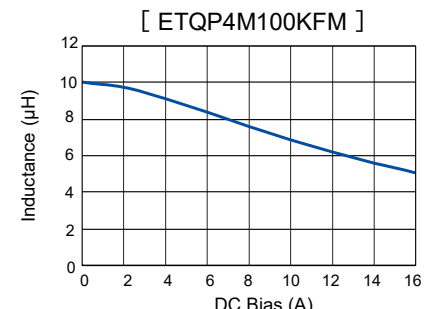
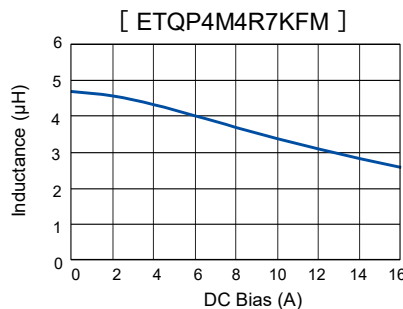
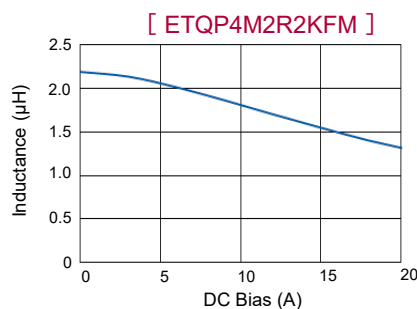
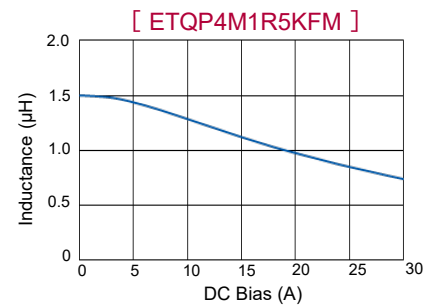
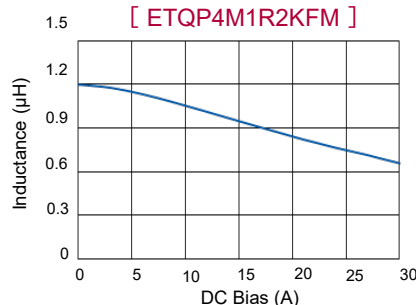
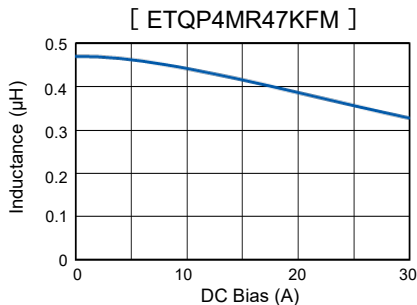

Performance characteristics (Reference①)

● Inductance vs DC Current

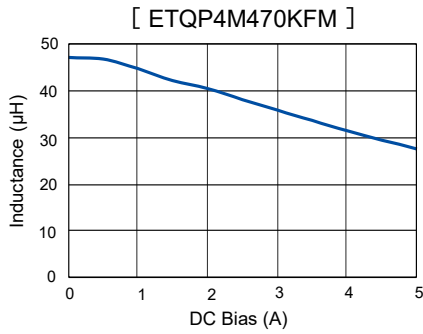

Performance characteristics (Reference②)

● Case Temperature vs DC Current

- PWB condition A : Four-layer PWB (1.6 mm FR4).<sup>\*3</sup>
- - - PWB condition B : Multilayer PWB with high heat dissipation performance.<sup>\*2</sup>

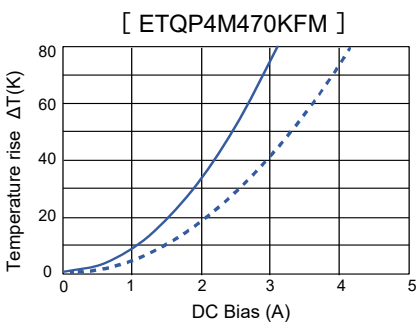
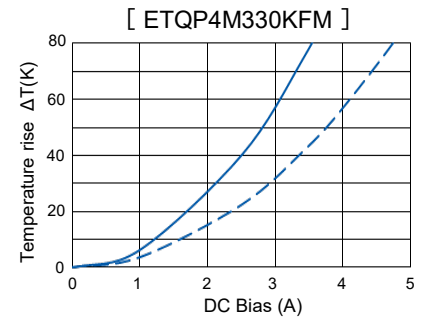
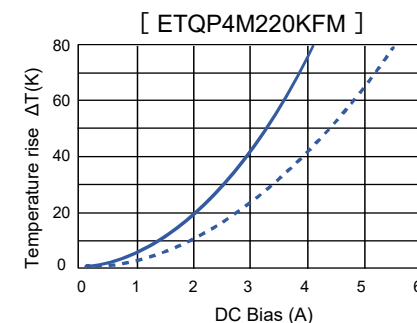
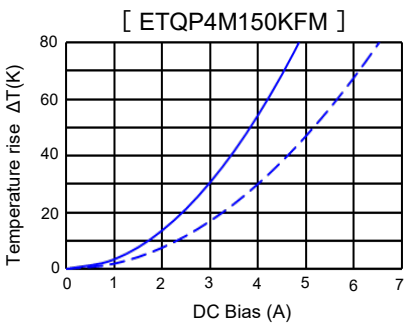
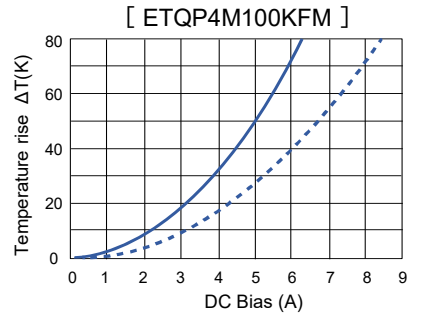
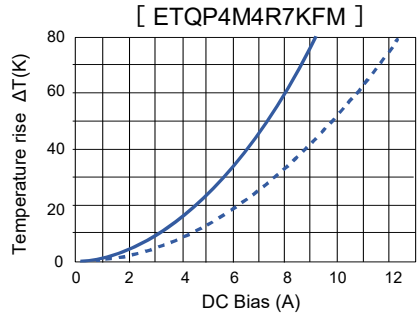
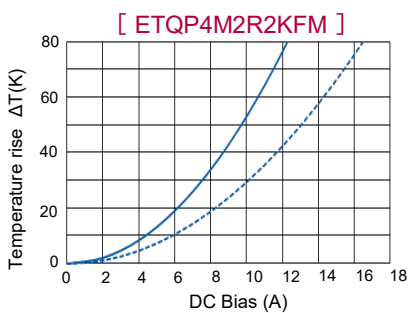
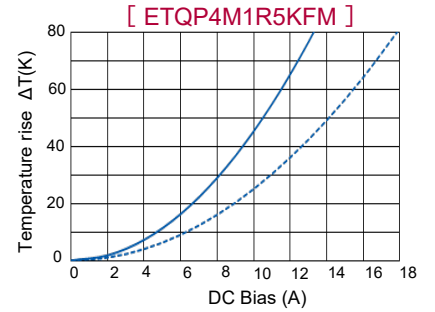
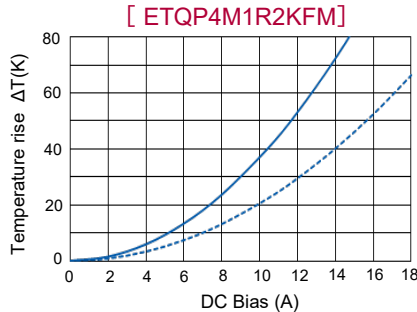
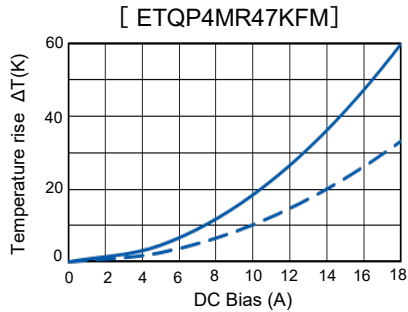

## Power Choke Coil (Automotive Grade)

### Dimensions in mm (not to scale)

Dimensional tolerance unless noted :  $\pm 0.5$

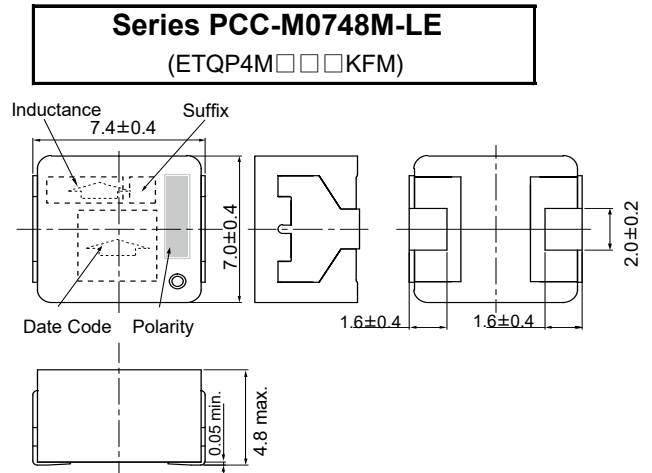
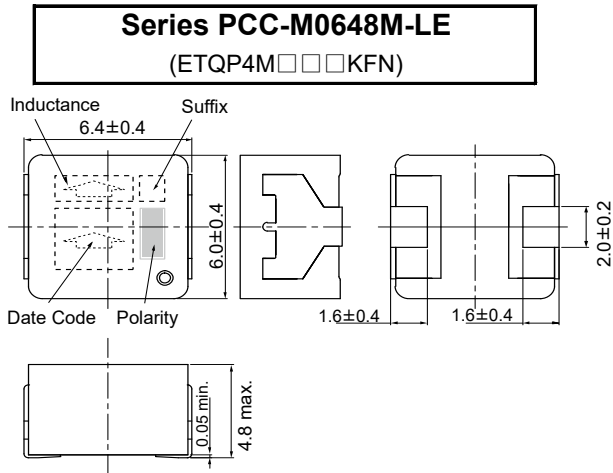

Unit : mm

### Recommended land pattern in mm (not to scale)

Dimensional tolerance unless noted :  $\pm 0.5$

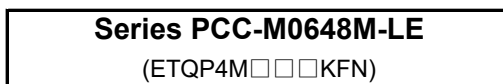

※Don't wire on the pattern on shaded portion the PWB.

Unit : mm

- As for soldering conditions and safety precautions (Power choke coils (Automotive grade)), please see data files

**Packaging methods (Taping)**

- Embossed Carrier Tape Dimensions in mm (not to scale)

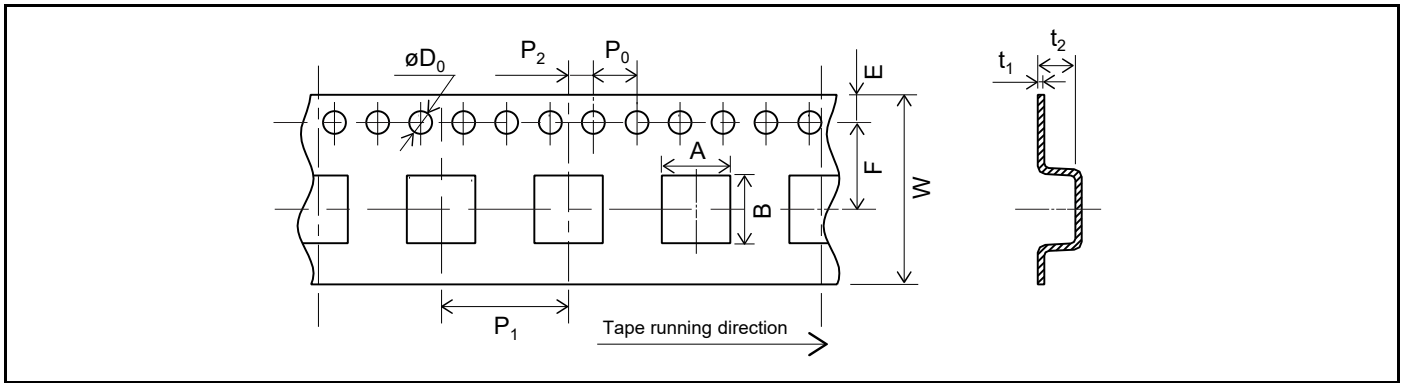

Series	A	B	W	E	F	P <sub>1</sub>	P <sub>2</sub>	P <sub>0</sub>	øD <sub>0</sub>	t <sub>1</sub>	t <sub>2</sub>
PCC-M0648M-LE	6.6	7.1	16	1.75	7.5	12	2	4	1.5	0.4	5.0
PCC-M0748M-LE	7.6	8.1	16	1.75	7.5	12	2	4	1.5	0.4	6.0

Unit : mm

- Taping Reel Dimensions in mm (not to scale)

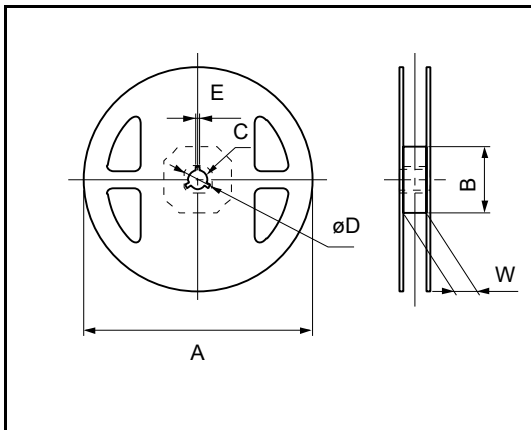

Series	A	B	C	øD	E	W
PCC-M0648M-LE	330	(100)	13	21	2	17.5
PCC-M0748M-LE						

Unit : mm

**Parts mounting (Taping)**

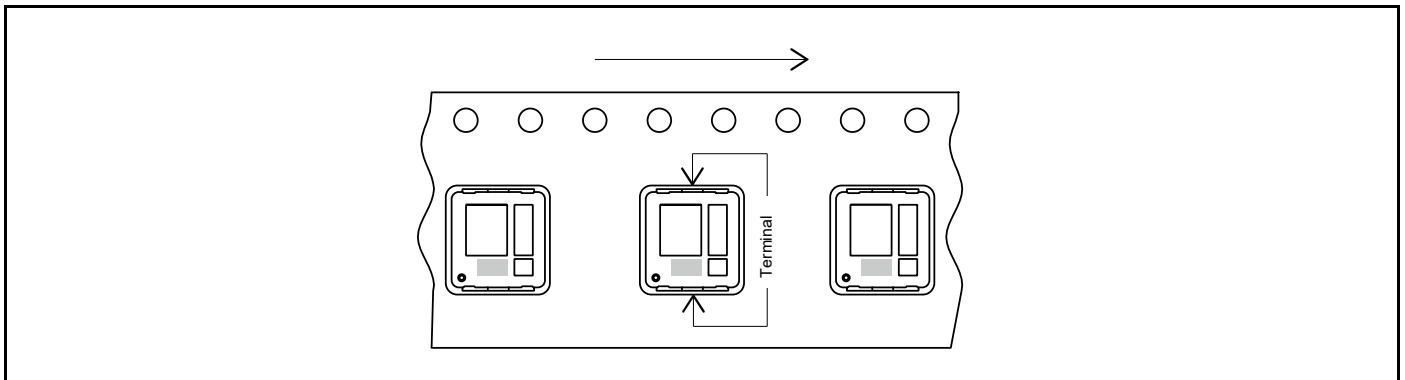

**Standard packing quantity / Reel**

Series	Part No.	Minimum quantity / Packing unit	Quantity per reel
PCC-M0648M-LE	ETQP4M□□□KFN	1,000 pcs / box (2 reel)	500 pcs
PCC-M0748M-LE	ETQP4M□□□KFM		

## Safety and Legal Matters to Be Observed

### Product specifications and applications

- Please be advised that this product and product specifications are subject to change without notice for improvement purposes. Therefore, please request and confirm the latest delivery specifications that explain the specifications in detail before the final design, or purchase or use of the product, regardless of the application. In addition, do not use this product in any way that deviates from the contents of the company's delivery specifications.
- Unless otherwise specified in this catalog or the product specifications, this product is intended for use in general electronic equipment (AV products, home appliances, commercial equipment, office equipment, information and communication equipment, etc.).  
When this product is used for the following special cases, the specification document suited to each application shall be signed/sealed (with Panasonic Industry and the user) in advance..These include applications requiring special quality and reliability, wherein their failures or malfunctions may directly threaten human life or cause harm to the human body (e.g.: space/aircraft equipment, transportation/traffic equipment, combustion equipment, medical equipment, disaster prevention/crime prevention equipment, safety equipment, etc.).

### Safety design and product evaluation

- Please ensure safety through protection circuits, redundant circuits, etc., in the customer's system design so that a defect in our company's product will not endanger human life or cause other serious damage.
- This catalog shows the quality and performance of individual parts. The durability of parts varies depending on the usage environment and conditions. Therefore, please ensure to evaluate and confirm the state of each part after it has been mounted in your product in the actual operating environment before use.  
If you have any doubts about the safety of this product, then please notify us immediately, and be sure to conduct a technical review including the above protection circuits and redundant circuits at your company.

### Laws / Regulations / Intellectual property

- The transportation of dangerous goods as designated by UN numbers, UN classifications, etc., does not apply to this product. In addition, when exporting products, product specifications, and technical information described in this catalog, please comply with the laws and regulations of the countries to which the products are exported, especially those concerning security export control.
- Each model of this product complies with the RoHS Directive (Restriction of the use of hazardous substances in electrical and electronic equipment) (2011/65/EU and (EU) 2015/863). The date of compliance with the RoHS Directive and REACH Regulation varies depending on the product model.  
Further, if you are using product models in stock and are not sure whether or not they comply with the RoHS Directive or REACH Regulation, please contact us by selecting "Sales Inquiry" from the inquiry form.
- During the manufacturing process of this product and any of its components and materials to be used, Panasonic Industry does not intentionally use ozone-depleting substances stipulated in the Montreal Protocol and specific bromine-based flame retardants such as PBBs (Poly-Brominated Biphenyls) / PBDEs (Poly-Brominated Diphenyl Ethers). In addition, the materials used in this product are all listed as existing chemical substances based on the Act on the Regulation of Manufacture and Evaluation of Chemical Substances.
- With regard to the disposal of this product, please confirm the disposal method in each country and region where it is incorporated into your company's product and used.
- The technical information contained in this catalog is intended to show only typical operation and application circuit examples of this product. This catalog does not guarantee that such information does not infringe upon the intellectual property rights of Panasonic Industry or any third party, nor imply that the license of such rights has been granted.
- Design, materials, or process related to technical owned by Panasonic Industry are subject to change without notice.

**Panasonic Industry will assume no liability whatsoever if the use of our company's products deviates from the contents of this catalog or does not comply with the precautions. Please be advised of these restrictions.**

## Matters to Be Observed When Using This Product

### (Power inductor for Automotive)

#### Use environments and cleaning conditions

This product is not designed for use in special environments. Do not use in the following special environments or conditions as performance may be affected. If you use this product, please thoroughly verify its performance and reliability at your own risk.

- (1) Use in environments directly exposed to water, salt water, or oil, or in liquids such as water, oil, chemicals, or organic solvents.
- (2) Use in an environment exposed to direct sunlight such as outdoor exposure, ozone, radiation or ultraviolet rays, or dust.
- (3) Use in a place with large amounts of moisture (Condensation, water leakage, etc.), sea breeze, corrosive gases such as Cl<sub>2</sub>, H<sub>2</sub>S, NH<sub>3</sub>, SO<sub>2</sub>, NO<sub>x</sub>, etc.
- (4) Environment filled with toxic gases (Hydrogen sulfide, sulfurous acid, nitrous acid, chlorine and its compounds, bromine and its compounds, ammonia, etc.)
- (5) Use in an acidic or alkaline environment.
- (6) Use in an environment where the voltage exceeds HBM (2 kV), MM (200 V) or where there are strong electromagnetic waves.
- (7) Use solvents, water, water-soluble detergents, etc. for soldering and flux cleaning after soldering.
- (8) Use after sealing or coating the product with resin, etc.
- (9) Use when shock or stress is applied by dropping or excessive loading.

#### Response to anomalies and handling conditions

- The inductor, as a single component, does not have a protective function against a problem such as overloading, short circuit, or open failure. Make sure to provide a circuit set with a protection device or circuit that protects the inductor, and confirm that smoke generation/ignition, weakened dielectric strength, lower insulation resistance, etc., do not occur.
- The temperature rise rate of the inductor changes depending on the state in which the inductor is incorporated in the circuit set. Make sure to confirm that the temperature of the inductor is equal to or lower than the temperature corresponding to the specified insulation class (heat-resistant class) when the inductor is incorporated in the circuit set.
- Do not use this product in circuit conditions where the voltage load exceeds the specified dielectric strength.
- When severe mechanical stress is applied to an inductor, its core may chip or crack.  
There are also some cases where the core already has a chipped or cracked part. However, this chip or crack is negligible and has no effect on the quality of the inductor.

#### Reliability and product life

A product conforming to "AEC-Q200" refers to a product having passed some or all of the evaluation test items defined in AEC-Q200. To know the detailed specifications of individual products or specific evaluation test scores, please contact us. We issue a delivery specification sheet for each product ordered. Please confirm with the sheet when you place an order with us.

#### Circuit design and circuit board design

- When the inductor is used in a different product set among a series of similar product sets, there are times when the inductor will fail to achieve 100% of its capability because of the difference in service conditions, etc. In such a case, consult us first.
- When the inductor is used in an audible frequency range (= about 20 Hz to 20 kHz) or burst mode, it may emit a sound (beat) under certain operation conditions (current waveform conditions). This sound may be heard as noise, depending on circuits/board configurations in which the inductor is incorporated. Check for this problem before using the inductor.
- When there is a possibility that electrostatic noise is applied to circuit components, place an ESD preventing component, such as a capacitor resistant to static electricity, in a preceding stage to the inductor. In such a case, consult us first.

- To ensure insulation between the internal coil of the inductor and the upper surface of the board, avoid forming patterns or vias in which voltage exceeding the guaranteed operating voltage is applied, on the uppermost layer of the board in counter to the inductor bottom. (DUST series)
- Do not form a pattern, via, etc., on the counter to the bottom of the inductor. (MC series/\* Fig.1, Dust type/\*Fig.2)
- Keep a component placed around the inductor from being in contact with the surface (top face, side face) of the inductor. (MC series/\* Fig. 3)
- Different from a ferrite core type with a magnetic energy concentration gap, the inductor described herein has a vertical leakage flux distribution.  
Exercise special caution when using a component or a circuit configuration susceptible to leakage flux from an inductor.

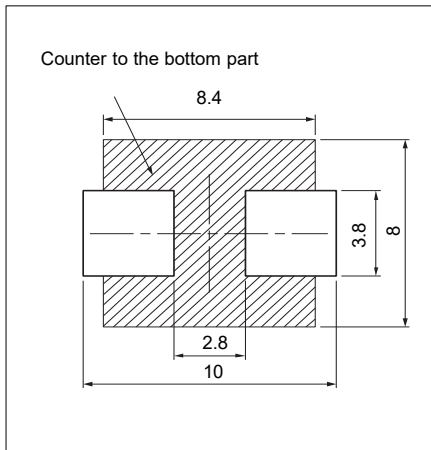

Fig.1

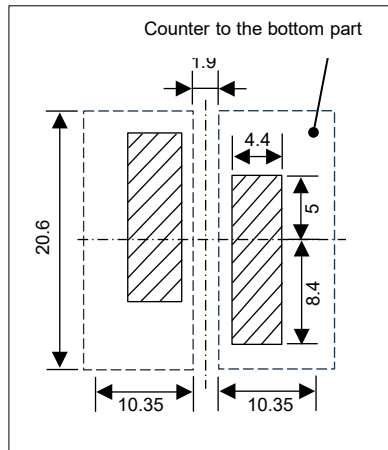

Fig.2

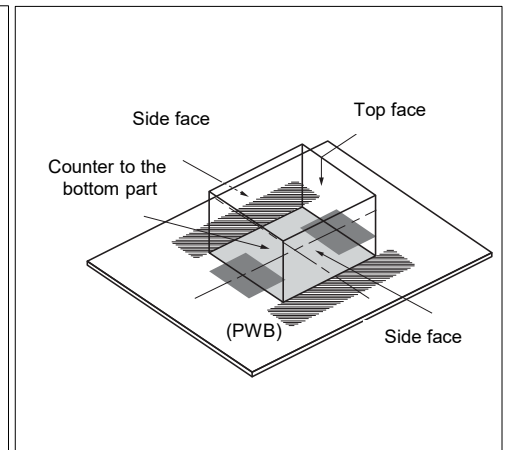

Fig.3

## Reference information

### Labeling on package

On the inductor package, a product number, the number of components, and the place of origin are indicated. Usually, the place of origin is written in English.