

WLB32 Industrial LED Light Bar (DC) Instruction Manual





Contents

Chapter 1 Features and Models	3
Chapter 2 WLB32 (DC) Wiring	5
Chapter 3 WLB32 (DC) Specifications	
FCC Part 15 Class B for Unintentional Radiators.....	7
Industry Canada ICES-003(B).....	7
WLB32 Dimensions	8
Spacing Criteria (SC).....	8
WLB Light Characteristics	9
Chapter 4 Accessories	
Cordsets	12
Enclosure Accessories	14
Brackets.....	14
Chapter 5 Product Support and Maintenance	
Banner Engineering Corp Limited Warranty	15
Mexican Importer	15
Document Information	15

Chapter Contents

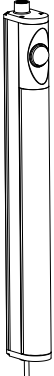
Chapter 1 Features and Models

 <p>Model without Motion Detector</p>	 <p>Model with Motion Detector</p>	 <p>Model with Eye Shield and Motion Detector</p>	<p>Banner's WLB32 is an ultra-bright LED fixture that features an even light output for a no-glare 'glow'. Suitable for a variety of environments and applications, including workstations, machine lighting, control cabinets, and manufacturing lines, the WLB32 uses advanced LED lighting technology to provide a high-quality and maintenance-free industrial lighting solution for years.</p> <ul style="list-style-type: none"> • Highly energy efficient for overall cost savings • High/Low/Off switch • Models with eye shield block side glare • Connect power in sequence to multiple lights • Motion detection models available • Metal housing, shatterproof window • Easy installation with snap clips, or a choice of magnetic or angle brackets <p>WLB32 Industrial LED Light Bars are available in models that can be connected in sequence together for a continuous length of lighting, with a minimum of wiring. Each light bar can be turned to high, low, or off independently of the other lights, upstream or downstream, in the chain of lights. A double-ended accessory cordset must be used between each pair of connecting lights.</p>
--	---	--	---

12 V DC to 30 V DC Models			
Models	Lighted Length (mm)	Connector	Lumens
WLB32C285PBQ	285	Integral 4-pin M12 quick-disconnect connector	750
WLB32C570PBQ	570		1500
WLB32C850PBQ	850		2250
WLB32C1130PBQ	1130		3000
WLB32C285PB	285	2 m (6.5 ft) cable	750
WLB32C570PB	570		1500
WLB32C850PB	850		2250
WLB32C1130PB	1130		3000

- To order the light without the integral switch, omit the "PB" from the model number. For example, WLB32C285Q.
- To order the light with the integral motion detector, replace the 'PB' from the model number with 'M'. For example, WLB32C285MQ.
- To order the light with the eye shield, add an 'E' after the length. For example, WLB32C285EPBQ.

IMPORTANT: Read the following instructions before operating the light. Please download the complete WLB32 Industrial Light Bar (DC) technical documentation, available in multiple languages, from www.bannerengineering.com for details on the proper use, applications, Warnings, and installation instructions of this device.

IMPORTANT: Lea el siguiente instructivo antes de operar el luminario. Por favor descargue desde www.bannerengineering.com toda la documentación técnica de los WLB32 Industrial Light Bar (DC), disponibles en múltiples idiomas, para detalles del uso adecuado, aplicaciones, advertencias, y las instrucciones de instalación de estos dispositivos.

IMPORTANT: Lisez les instructions suivantes avant d'utiliser le luminaire. Veuillez télécharger la documentation technique complète des WLB32 Industrial Light Bar (DC) sur notre site www.bannerengineering.com pour les détails sur leur utilisation correcte, les applications, les notes de sécurité et les instructions de montage.

Chapter Contents

Chapter 2 WLB32 (DC) Wiring

	Wiring	Pinouts (Female and Male)	Wiring Key
Switch Models		<p>Female</p>	<p>1 = Brown 3 = Blue</p>
Non-Switch and Motion Detector Models		<p>Male</p>	<p>1 = Brown, connect for 100% intensity 3 = Blue 4 = Black*</p> <p>* For models without motion detection, connect the black wire to 12 to 30 V DC for 50% maximum intensity. For models with motion detection, connect the black wire to 12 to 30 V DC to bypass the motion detector switch.</p>

Chapter Contents

FCC Part 15 Class B for Unintentional Radiators 7
 Industry Canada ICES-003(B)..... 7
 WLB32 Dimensions..... 8
 Spacing Criteria (SC) 8
 WLB Light Characteristics 9

Chapter 3 WLB32 (DC) Specifications

Supply Voltage

12 V DC to 30 V DC
 Use only with a suitable Class 2 power supply (UL) or SELV power supply (CE)
 See electrical characteristics on product label

Supply Protection Circuitry

Protected against reverse polarity and transient voltages

LED Lifetime

Lumen Maintenance - L70
 When operating within specifications, output will decrease less than 30% after 70,000 hours.

Supply Current

Light Length (mm)	Maximum Current Draw (A)	Typical Current Draw (A)		
		12 V DC	24 V DC	30 V DC
285	0.55	0.45	0.23	0.19
570	1.1	0.90	0.44	0.36
850	1.6	1.36	0.65	0.54
1130	2.2	1.8	0.84	0.68

Light Characteristics

Color: Daylight white
 Color temperature (CCT): 5000K (±300K)
 Lumen output: 750 (±5%) per foot, typical at 25 °C (77 °F)
 Luminous efficacy: 140 lumens/Watt typical at 24 V DC at 25 °C (77 °F)
 CRI: 82, typical
 Eye shield reduces lumens by about 25%

Push Button

II = 100% light intensity
 I = 50% light intensity
 O = Off

Models with Motion Detection

Light turns off after approximately 60 seconds without detecting motion.
 Range: 12 meters; ±45° field of view
 Standby current: 170 µA

Construction

Anodized aluminum housing; polycarbonate window and end caps; stainless steel mounting brackets

Spacing Criterion

Vertical: 1.22
 Horizontal: 1.32

Mounting

Snap clips; optional magnetic mount or swivel bracket accessories available

Connections

Integral 4-pin M12 quick-disconnect connector (4-pin connecting cordset required for quick-disconnect models); or 2 m (6.5 ft) integral cable

Environmental Rating

IP50

Vibration and Mechanical Shock

Meets IEC 60068-2-6 requirements (Vibration: 10 Hz to 55 Hz, 1.0 mm amplitude, 5 minutes sweep, 30 minutes dwell)
 Meets IEC 60068-2-27 requirements (Shock: 15G 11 ms duration, half sine wave)

Operating Temperature

-40 °C to +70 °C (-40 °F to +158 °F)
 Light output begins to decrease above 50 °C (122 °F) and will be approximately 65% of max intensity at 60 °C (140 °F) and 30% of max intensity at 70 °C (158 °F)
 Models with motion detection: -20 °C to +60 °C (-4 °F to +140 °F)

Storage Temperature

-40 °C to +70 °C (-40 °F to +158 °F)

Test Data

LM-79, LM-80, TM-21

Certifications

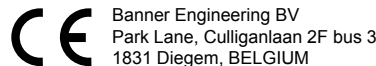

UL Recognized for easy installation in control cabinets.



Required Overcurrent Protection



WARNING: Electrical connections must be made by qualified personnel in accordance with local and national electrical codes and regulations.

Overcurrent protection is required to be provided by end product application per the supplied table.

Overcurrent protection may be provided with external fusing or via Current Limiting, Class 2 Power Supply.

Supply wiring leads < 24 AWG shall not be spliced.

For additional product support, go to www.bannerengineering.com.

Supply Wiring (AWG)	Required Overcurrent Protection (A)	Supply Wiring (AWG)	Required Overcurrent Protection (A)
20	5.0	26	1.0
22	3.0	28	0.8
24	1.0	30	0.5

Application Note

When connecting cascable lights in series it is important not to exceed the maximum current limitation of 4 Amps
 Maximum length of light at 12 V DC: 2 m (6.6 ft)
 Maximum length of light at 24 V DC: 4.8 m (15.7 ft)
 Maximum length of light at 30 V DC: 5.9 m (19.4 ft)

FCC Part 15 Class B for Unintentional Radiators

(Part 15.105(b)) This equipment has been tested and found to comply with the limits for a Class B digital device, pursuant to part 15 of the FCC Rules. These limits are designed to provide reasonable protection against harmful interference in a residential installation. This equipment generates, uses, and can radiate radio frequency energy and, if not installed and used in accordance with the instructions, may cause harmful interference to radio communications. However, there is no guarantee that interference will not occur in a particular installation. If this equipment does cause harmful interference to radio or television reception, which can be determined by turning the equipment off and on, the user is encouraged to try to correct the interference by one or more of the following measures:

- Reorient or relocate the receiving antenna.
- Increase the separation between the equipment and receiver.
- Connect the equipment into an outlet on a circuit different from that to which the receiver is connected.
- Consult the dealer or an experienced radio/TV technician for help.

(Part 15.21) Any changes or modifications not expressly approved by the party responsible for compliance could void the user's authority to operate this equipment.

Industry Canada ICES-003(B)

This device complies with CAN ICES-3 (B)/NMB-3(B). Operation is subject to the following two conditions: 1) This device may not cause harmful interference; and 2) This device must accept any interference received, including interference that may cause undesired operation.

Cet appareil est conforme à la norme NMB-3(B). Le fonctionnement est soumis aux deux conditions suivantes : (1) ce dispositif ne peut pas occasionner d'interférences, et (2) il doit tolérer toute interférence, y compris celles susceptibles de provoquer un fonctionnement non souhaité du dispositif.

WLB32 Dimensions

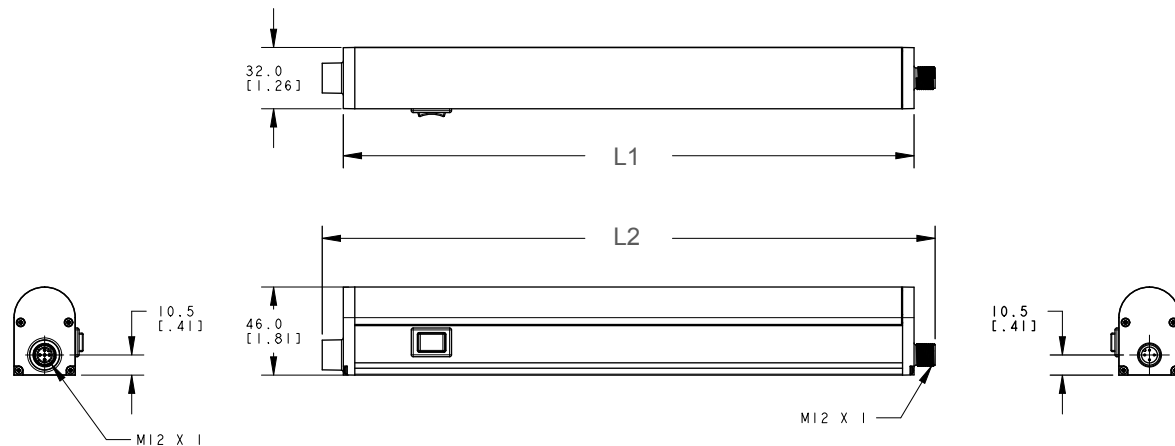

Motion Detector and/or Eye Shield Models

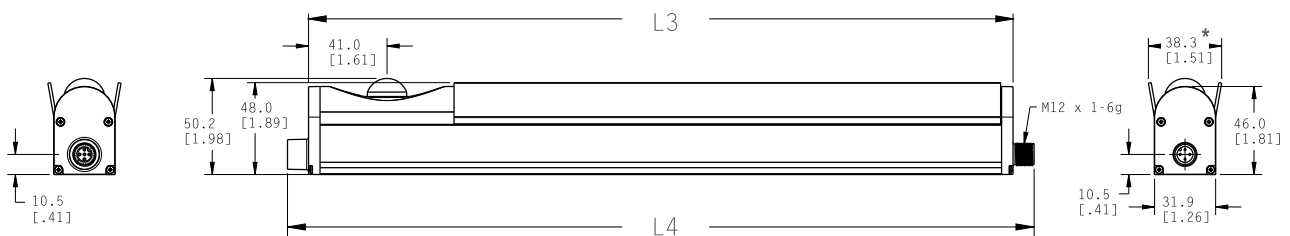

* Specific to models with shield

Models	Models without Motion Detector		Models with Motion Detector and/or Eye Shields	
	L1	L2	L3	L4
WLB32C285..Q	298 mm (11.7 in)	320 mm (12.6 in)	368 mm (14.5 in)	390 mm (15.4 in)
WLB32C570..Q	580 mm (22.8 in)	602 mm (23.7 in)	650 mm (25.6 in)	672 mm (26.5 in)
WLB32C850..Q	862 mm (33.9 in)	884 mm (34.8 in)	932 mm (36.7 in)	954 mm (37.6 in)
WLB32C1130..Q	1144 mm (45.0 in)	1166 mm (45.9 in)	1214 mm (47.8 in)	1236 mm (48.7 in)
WLB32C285..	298 mm (11.7 in)	313 mm (12.3 in)	368 mm (14.5 in)	383 mm (15.1 in)
WLB32C570..	580 mm (22.8 in)	595 mm (23.4 in)	650 mm (25.6 in)	665 mm (26.2 in)
WLB32C850..	862 mm (33.9 in)	877 mm (34.5 in)	932 mm (36.7 in)	947 mm (37.3 in)
WLB32C1130..	1144 mm (45.0 in)	1159 mm (45.6 in)	1214 mm (47.8 in)	1229 mm (48.4 in)

Spacing Criteria (SC)

The spacing criteria is the fixture-spacing-to-mounting-height ratio and aids in laying out a pattern of fixtures. Multiply the spacing criteria by the mounting height to get the maximum fixture spacing that still provides even illumination (no shadowing between fixtures).

Luminaire Spacing = SC × Height to Illuminated Plane

The mounting height is the distance from the fixture to the surface you are lighting.

WLB Light Characteristics

285 mm Models

Illuminance at a Distance

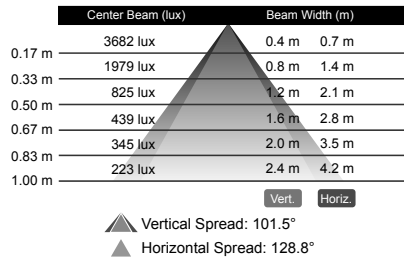

Isolux Pattern

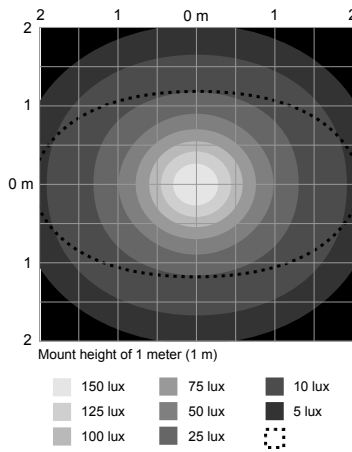

Polar Candela Distribution

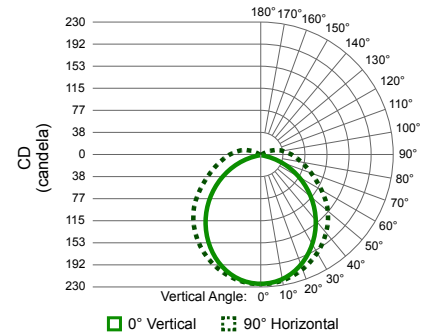

Illuminance at a Distance

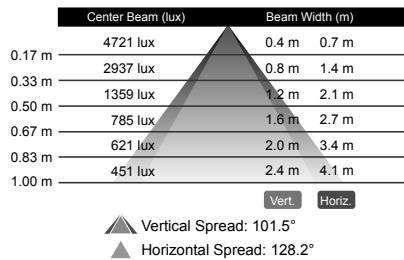

570 mm Models

Isolux Pattern

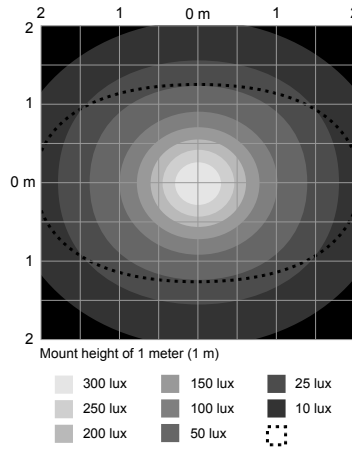

Polar Candela Distribution

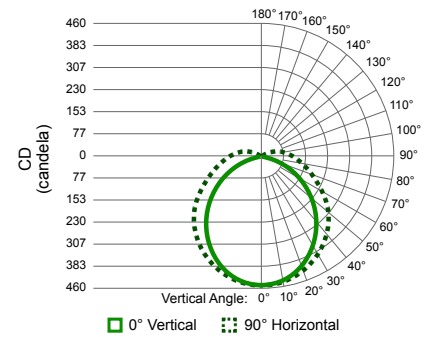

Illuminance at a Distance

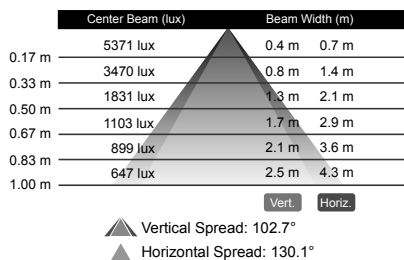

850 mm Models

Isolux Pattern

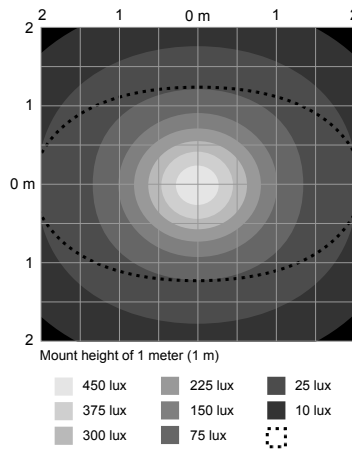

Polar Candela Distribution

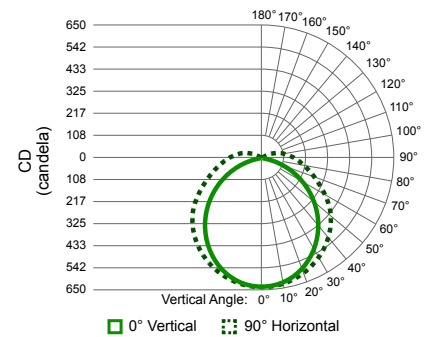

Illuminance at a Distance

1130 mm Models

Illuminance at a Distance

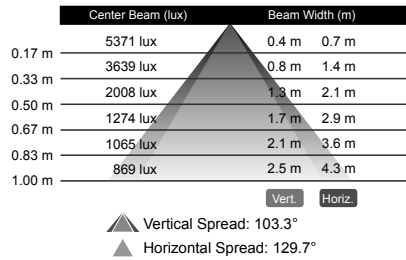

Isolux Pattern

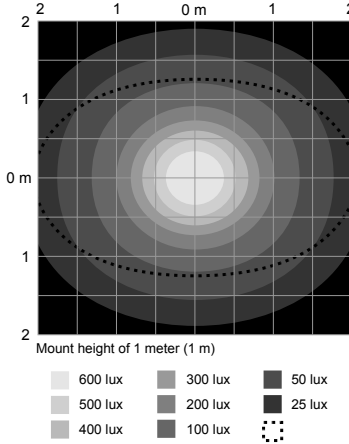

Polar Candela Distribution

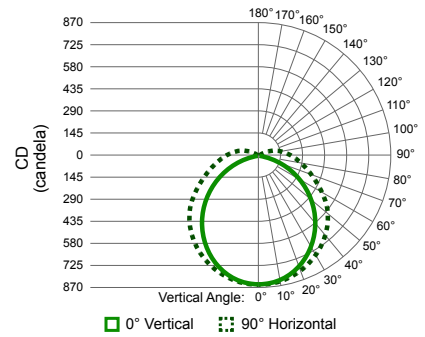

Illuminance at a Distance

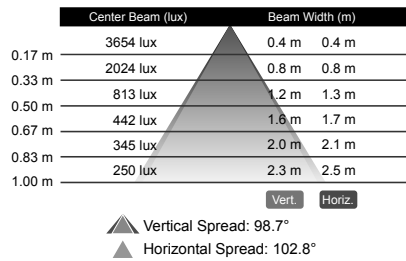

285 mm Models with Eye Shields

Isolux Pattern

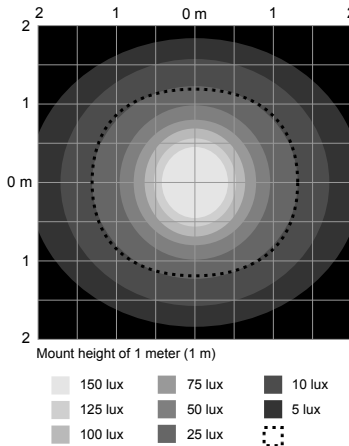

Polar Candela Distribution

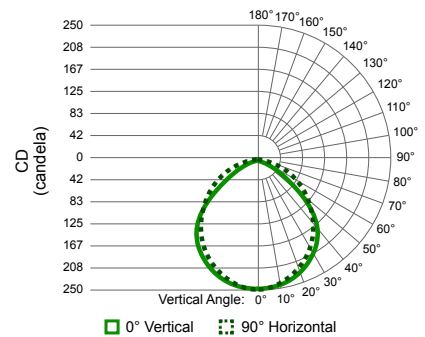

Illuminance at a Distance

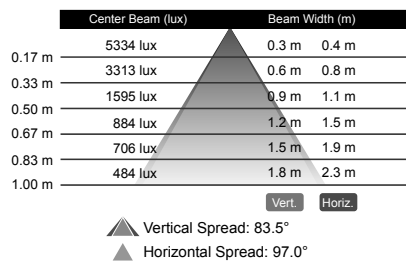

570 mm Models with Eye Shields

Isolux Pattern

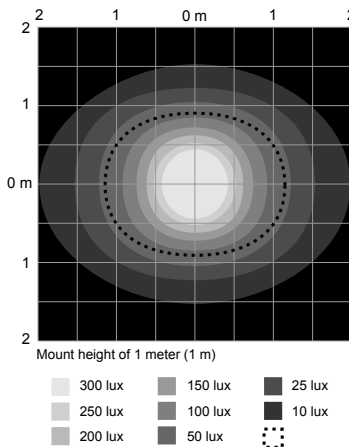

Polar Candela Distribution

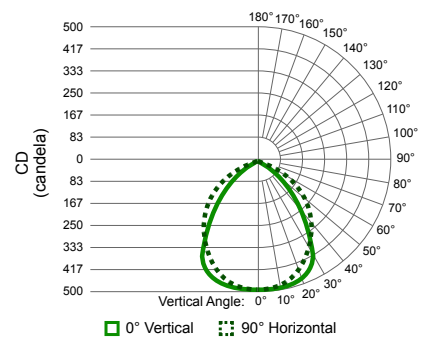

Illuminance at a Distance

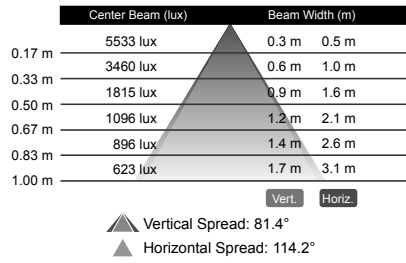

850 mm Models with Eye Shields

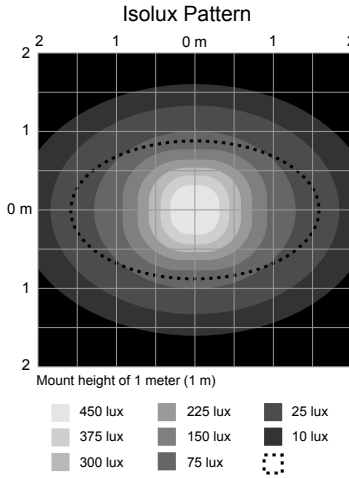

Polar Candela Distribution

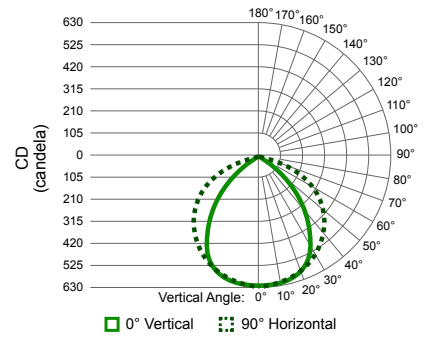

Illuminance at a Distance

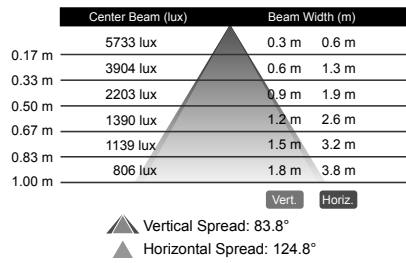

1130 mm Models with Eye Shields

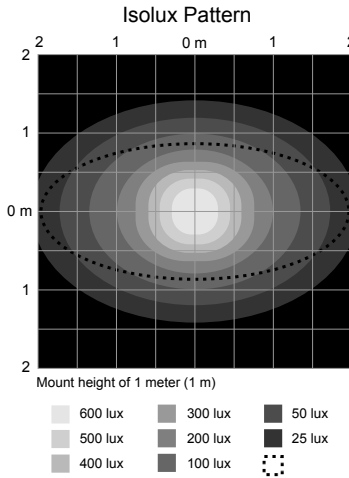

Polar Candela Distribution

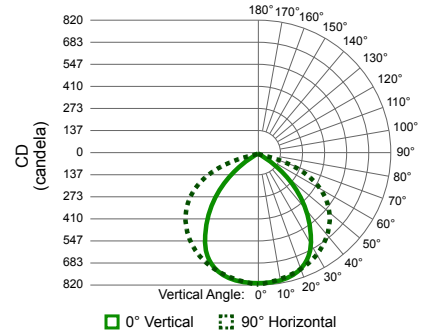

Chapter Contents

Cordsets 12
 Enclosure Accessories 14
 Brackets 14

Chapter 4 Accessories

Cordsets

4-Pin Single-Ended M12 Female Cordsets				
Model	Length	Style	Dimensions	Pinout (Female)
MQDC-406	2 m (6.56 ft)	Straight		
MQDC-415	5 m (16.4 ft)			
MQDC-430	9 m (29.5 ft)			
MQDC-450	15 m (49.2 ft)	Right-Angle		
MQDC-406RA	2 m (6.56 ft)			
MQDC-415RA	5 m (16.4 ft)			
MQDC-430RA	9 m (29.5 ft)			
MQDC-450RA	15 m (49.2 ft)			

- 1 = Brown
- 2 = White
- 3 = Blue
- 4 = Black
- 5 = Unused



4-Pin Double-Ended M12 Female to M12 Male Cordsets				
Model	Length	Style	Dimensions	Pinout
MQDEC-401SS	0.31 m (1 ft)	Male Straight / Female Straight		<p>Female</p>
MQDEC-403SS	0.91 m (2.99 ft)			
MQDEC-406SS	1.83 m (6 ft)			
MQDEC-412SS	3.66 m (12 ft)			
MQDEC-415SS	4.58 m (15 ft)			
MQDEC-420SS	6.10 m (20 ft)			
MQDEC-430SS	9.14 m (30.2 ft)			
MQDEC-450SS	15.2 m (49.9 ft)			
MQDEC-403RS	0.91 m (2.99 ft)	Male Right-Angle / Female Straight		<p>Male</p> <p>1 = Brown 2 = White 3 = Blue 4 = Black</p>
MQDEC-406RS	1.83 m (6 ft)			
MQDEC-412RS	3.66 m (12 ft)			
MQDEC-420RS	6.10 m (20 ft)			
MQDEC-430RS	9.14 m (30.2 ft)			
MQDEC-450RS	15.2 m (49.9 ft)			
MQDEC-403RR	0.9 m (2.9 ft)	Male Right-Angle / Female Right-Angle		<p>1 = Brown 2 = White 3 = Blue 4 = Black</p>
MQDEC-406RR	1.8 m (5.9 ft)			
MQDEC-412RR	3.6 m (11.8 ft)			
MQDEC-420RR	6.1 m (20 ft)			

4-Pin Flat Junction M12 Female Branch to M12 Male Trunk Splitter Cordsets			
Model	Branches (Female)	Trunk (Male)	Pinout
CSB-M1240M1240	No branch	No trunk	<p>Female</p> <p>Male</p> <p>1 = Brown 2 = White 3 = Blue 4 = Black</p>
CSB-M1240M1241	2 × 0.3 m (1 ft)	No trunk	
CSB-M1241M1241		0.31 m (1 ft)	
CSB-M1248M1241		2.44 m (8 ft)	
CSB-M12415M1241		4.57 m (15 ft)	
CSB-M12425M1241		7.60 m (25 ft)	
CSB-UNT425M1241		7.60 m (25 ft) Untermated	
CSB-M1243M1243	2 × 1 m (3.28 ft)	1 m (3.28 ft)	

Enclosure Accessories

LMBEDS Switch

- Bracket with plunger switch to power lights when the enclosure is opened
- Refer to datasheet [160672](#) for more information



Brackets

LMBWLB32

- Replaces the bracket that ships with the WLB32 light
- Stainless steel
- Includes 4 snap clips, 4 screws, and 2 insulator caps

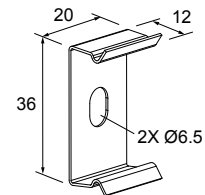

LMBWLB32-180S

- Swivel bracket kit allows 180° of movement

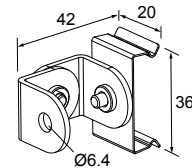

LMBWLB32MAG

- Magnetic mounting bracket for easy attachment to steel and iron surfaces

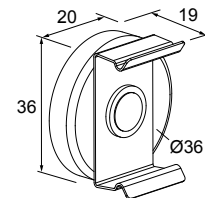

LMBWLB32U

- Die-cast bracket for rugged applications
- Secured to light with included thumb screw
- Clearance hole for 6 mm (1/4 in) button head screw

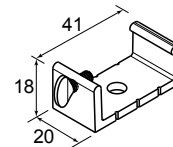

LMBWLB32UT

- Die-cast bracket for rugged applications
- Secured to light with included thumb screw
- Integral 1/4-20 stud for mounting

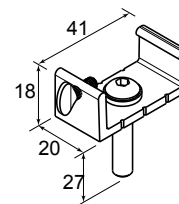

Chapter Contents

Banner Engineering Corp Limited Warranty..... 15

Mexican Importer..... 15

Document Information..... 15

Chapter 5 Product Support and Maintenance

Banner Engineering Corp Limited Warranty

Banner Engineering Corp. warrants its products to be free from defects in material and workmanship for one year following the date of shipment. Banner Engineering Corp. will repair or replace, free of charge, any product of its manufacture which, at the time it is returned to the factory, is found to have been defective during the warranty period. This warranty does not cover damage or liability for misuse, abuse, or the improper application or installation of the Banner product.

THIS LIMITED WARRANTY IS EXCLUSIVE AND IN LIEU OF ALL OTHER WARRANTIES WHETHER EXPRESS OR IMPLIED (INCLUDING, WITHOUT LIMITATION, ANY WARRANTY OF MERCHANTABILITY OR FITNESS FOR A PARTICULAR PURPOSE), AND WHETHER ARISING UNDER COURSE OF PERFORMANCE, COURSE OF DEALING OR TRADE USAGE.

This Warranty is exclusive and limited to repair or, at the discretion of Banner Engineering Corp., replacement. **IN NO EVENT SHALL BANNER ENGINEERING CORP. BE LIABLE TO BUYER OR ANY OTHER PERSON OR ENTITY FOR ANY EXTRA COSTS, EXPENSES, LOSSES, LOSS OF PROFITS, OR ANY INCIDENTAL, CONSEQUENTIAL OR SPECIAL DAMAGES RESULTING FROM ANY PRODUCT DEFECT OR FROM THE USE OR INABILITY TO USE THE PRODUCT, WHETHER ARISING IN CONTRACT OR WARRANTY, STATUTE, TORT, STRICT LIABILITY, NEGLIGENCE, OR OTHERWISE.**

Banner Engineering Corp. reserves the right to change, modify or improve the design of the product without assuming any obligations or liabilities relating to any product previously manufactured by Banner Engineering Corp. Any misuse, abuse, or improper application or installation of this product or use of the product for personal protection applications when the product is identified as not intended for such purposes will void the product warranty. Any modifications to this product without prior express approval by Banner Engineering Corp will void the product warranties. All specifications published in this document are subject to change; Banner reserves the right to modify product specifications or update documentation at any time. Specifications and product information in English supersede that which is provided in any other language. For the most recent version of any documentation, refer to: www.bannerengineering.com.

For patent information, see www.bannerengineering.com/patents.

Mexican Importer

Banner Engineering de México, S. de R.L. de C.V. | David Alfaro Siqueiros 103 Piso 2 Valle oriente | San Pedro Garza Garcia Nuevo León, C. P. 66269

81 8363.2714

Document Information

Document title: WLB32 Industrial Light Bar (DC)
Part number: 176313
Revision: L
Original Instructions
© Banner Engineering Corp. All rights reserved.



 [LinkedIn](#)

 [X \(formerly Twitter\)](#)

 [Facebook](#)

