

Features

- Advanced one-piece photoelectric sensors with outstanding optical performance and extremely rugged design
- Operate from 10 V DC to 30 V DC
- Bipolar NPN (sinking)/PNP (sourcing) outputs on all models
- Multiple sensing modes available: opposed, diffuse, retroreflective, and convergent, plus glass and plastic fiber optic models
- Selectable light/dark operate
- Versatile plug-in modules available for output timing logic and/or signal strength display
- Highly visible Power, Signal (AID™ System ⁽¹⁾), and Output indicator LEDs
- Choice of prewired 2 m (6.5 ft) unterminated cable, 9 m (30 ft) unterminated cable, 4-pin Mini male quick disconnect connector, or a 4-pin M12 male quick-disconnect connector
- Versatile mounting options
- Designed to withstand 1200 psi washdown; exceeds its NEMA 6P and IEC IP67 rating



WARNING:



- **Do not use this device for personnel protection**
- Using this device for personnel protection could result in serious injury or death.
- This device does not include the self-checking redundant circuitry necessary to allow its use in personnel safety applications. A device failure or malfunction can cause either an energized (on) or de-energized (off) output condition.

Models

To order the 9 m (30 ft) cable models, add the suffix "W/30" to the cabled model number. Models with a quick disconnect connector require a mating cable.

Q45BB6 Opposed-Mode Emitter (E) and Receiver (R) Models

In opposed-mode sensing, the sensor's emitter and receiver are housed in two separate units. The emitter is placed opposite the receiver so that the light beam goes directly from the emitter to the receiver. An object is detected when it breaks the working part of the light beam, known as the effective beam.

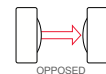

Because of their extremely high excess gain, these opposed-mode sensors are an excellent option for sensing in contaminated or dirty areas, and are also the best choice for long-range sensing.

Opposed mode sensors (infrared, 880 nm)

Models	Range	Cable	Supply Voltage	Output Type
Q456E Emitter	60 m (200 ft)	2-wire 2 m (6.5 ft) cable	10 V DC to 30 V DC	Bipolar NPN/PNP
Q45BB6R Receiver		4-wire 2 m (6.5 ft) cable		
Q456EQ Emitter		4-pin Mini male quick disconnect (QD)		
Q45BB6RQ Receiver				
Q456EQ5 Emitter		4-pin M12 male QD		
Q45BB6RQ5 Receiver				

The following models are no longer available for order but are still covered by the information in this document.

- Q456E W/30
- Q45BB6R W/30

Q45BB6 Retroreflective-Mode Models

A retroreflective sensor contains both the emitter and receiver elements. The effective beam is established between the emitter, the retroreflector, and the receiver. As with an opposed-mode sensor, an object is sensed when it interrupts or "breaks" the effective beam.

⁽¹⁾ U.S. Patent no. 4356393



The visible red sensing beam of these sensors makes them very easy to align. Model Q45BB6LP polarizes the emitted light and filters out unwanted reflections, making sensing possible in applications otherwise considered unsuited to retroreflective sensing.

Specified using the model BRT-3 3-inch reflector (go to www.bannerengineering.com additional information).

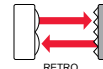

Visible red, 680 nm (non-polarized)



Visible red, 680 nm (polarized)

Non-polarized retroreflective mode sensors

Models	Range	Cable	Supply Voltage	Output Type
Q45BB6LV	0.08 to 9 m (3 in to 30 ft)	4-wire 2 m (6.5 ft) cable	10 V DC to 30 V DC	Bipolar NPN/PNP
Q45BB6LVQ		4-pin Mini male QD		
Q45BB6LVQ5		4-pin M12 male QD		

Polarized retroreflective mode sensors

Models	Range	Cable	Supply Voltage	Output Type
Q45BB6LP	0.15 to 6 m (6 in to 20 ft)	4-wire 2 m (6.5 ft) cable	10 V DC to 30 V DC	Bipolar NPN/PNP
Q45BB6LP W/30		4-wire 9 m cable		
Q45BB6LPQ		4-pin 7/8 in-16UNF QD		
Q45BB6LPQ5		4-pin M12 QD		

The following models are no longer available for order but are still covered by the information in this document.

- Q45BB6LV W/30

Q45BB6 Diffuse-Mode Models

In diffuse-mode sensing, light emitted from the sensor strikes the surface of the object to be detected and is reflected back to the receiver, which is housed with the emitter. With a diffuse-mode sensor, the object is detected when it "makes" the beam, that is, the object reflects the sensor's transmitted light energy back to the sensor.

These diffuse-mode models detect objects by sensing the reflection of their own emitted light. Ideal for use when the reflectivity and profile of the object to be sensed are sufficient to return a large percentage of emitted light back to the sensor.

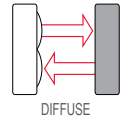

Model Q45BB6DX is the first choice for diffuse-mode applications when there are no background objects to falsely return light.

Short-range diffuse mode sensors (infrared, 880 nm)

Short Range				
Models	Range	Cable	Supply Voltage	Output Type
Q45BB6D	45 cm (18 in)	4-wire 2 m (6.5 ft) cable	10 V DC to 30 V DC	Bipolar NPN/PNP
Q45BB6DQ		4-pin Mini male QD		
Q45BB6DQ5		4-pin M12 male QD		

Long-range diffuse mode sensors (infrared, 880 nm)

Long Range				
Models	Range	Cable	Supply Voltage	Output Type
Q45BB6DL	1.8 m (6 ft)	4-wire 2 m (6.5 ft) cable	10 V DC to 30 V DC	Bipolar NPN/PNP
Q45BB6DL W/30		4-wire 9 m cable		
Q45BB6DLQ		4-pin Mini male QD		
Q45BB6DLQ5		4-pin M12 male QD		

High-power diffuse mode sensors (infrared, 880 nm)

High Power				
Models	Range	Cable	Supply Voltage	Output Type
Q45BB6DX	3 m (10 ft)	4-wire 2 m (6.5 ft) cable	10 V DC to 30 V DC	Bipolar NPN/PNP
Q45BB6DXQ		4-pin Mini male QD		
Q45BB6DXQ5		4-pin M12 male QD		

The following models are no longer available for order but are still covered by the information in this document.

- Q45BB6D W/30

- Q45BB6DX W/30

Q45BB6 Convergent-Mode Models

Convergent-mode sensors use a lens system to focus the emitter and receiver elements to an exact point in front of the sensor. Like diffuse-mode and divergent-mode sensors, convergent-mode sensors detect an object when that object completes or "makes" the light beam. This design produces a small, intense, and well-defined sensing area, at a fixed distance from the sensor lens. It is a very efficient use of reflective energy.

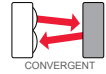

These sensors are ideal for reflective sensing of very small parts or profiles, and can accurately sense the position of parts approaching from the side. Ignores all but highly reflective objects that are outside the sensing range.

Convergent mode sensors (visible red, 680 nm)

Models	Focus	Cable	Supply Voltage	Output Type
Q45BB6CV	38 mm (1.5 in) Spot Size at Focus: 1.3 mm (0.05 in)	4-wire 2 m (6.5 ft) cable	10 V DC to 30 V DC	Bipolar NPN/PNP
Q45BB6CV W/30		4-wire 9 m cable		
Q45BB6CVQ5		4-pin M12 male QD		
Q45BB6CV4	100 mm (4 in) Spot Size at Focus: 1.5 mm (0.06 in)	4-wire 2 m (6.5 ft) cable	10 V DC to 30 V DC	Bipolar NPN/PNP
Q45BB6CV4Q5		4-pin M12 male QD		

The following models are no longer available for order but are still covered by the information in this document.

- Q45BB6CVQ
- Q45BB6CV4 W/30
- Q45BB6CV4Q

Q45BB6 Glass Fiber-Optic Models

These models are an excellent choice for glass fiber-optic applications where faster sensor response is not important. Their high excess gain means that opposed individual fibers can operate reliably in many very hostile environments. Also, special miniature bifurcated fiber-optic assemblies with bundle sizes as small as 0.5 mm (.020 in) diameter may be used successfully for diffuse-mode sensing when using sensor model Q45BB6F(Q).

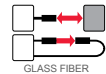

For more information on compatible glass fiber optics, go to www.bannerengineering.com.

Range: Range varies by sensing mode and fiber optics used.

Glass fiber-optic models (infrared, 880 nm)

Models	Cable	Supply Voltage	Output Type
Q45BB6F	4-wire 2 m (6.5 ft) cable	10 V DC to 30 V DC	Bipolar NPN/PNP
Q45BB6F W/30	4-wire 9 m cable		
Q45BB6FQ	4-pin Mini male QD		
Q45BB6FQ5	4-pin M12 male QD		

Glass fiber-optic models (visible red, 650 nm)

Models	Cable	Supply Voltage	Output Type
Q45BB6FV	4-wire 2 m (6.5 ft) cable	10 V DC to 30 V DC	Bipolar NPN/PNP
Q45BB6FVQ	4-pin Mini male QD		
Q45BB6FVQ5	4-pin M12 male QD		

Q45BB6 Plastic Fiber-Optic Models

Lower in cost than glass fiber optics, plastic fiber optics are ideal for use in situations where environmental conditions allow (for example, low levels of acids, alkalis, and solvents). Most are easily cut to length in the field, and are available in a variety of sensing end styles.

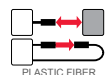

For more information on compatible plastic fiber-optics, go to www.bannerengineering.com

Range: Range varies by sensing mode and fiber optics used.

Plastic fiber-optic models (visible red, 660 nm)

Models	Cable	Supply Voltage	Output Type
Q45BB6FP	4-wire 2 m (6.5 ft) cable	10 V DC to 30 V DC	Bipolar NPN/PNP

Continued on page 4

Continued from page 3

Models	Cable	Supply Voltage	Output Type
Q45BB6FPQ	4-pin Mini male QD		
Q45BB6FPQ5	4-pin M12 male QD		

The following models are no longer available for order but are still covered by the information in this document.

- Q45BB6FP W/30

Overview

Status indicator LEDs for power, signal, and output are clearly visible beneath a raised dome in the sensor's transparent o-ring-sealed polycarbonate cover. Also located beneath the sensor's o-ring-sealed cover are controls for light/dark operate selection and the sensitivity adjustment.

- The power indicator (green) lights when power is applied to the sensor.
- The signal indicator (red) lights when the sensor sees its modulated light source and pulses at a rate proportional to the strength of the received light signal; this is the AID™ Alignment Indicating Device⁽²⁾.
- The output indicator (amber) lights when the sensor's output is conducting. This indicator is especially useful when a timing logic module is used and signal and output conditions are not concurrent.

In dark operate (DO) mode, the output is ON when the target returns less light to the sensor than the configured target and OFF when the sensor detects more light than the configured/taught target. In light operate (LO) mode, the output is ON when the target returns the same or more light to the sensor and OFF when the sensor detects less light than the configured/taught target. In **opposed and retroreflective sensing modes**, dark operate is active when the beam is blocked. In **diffuse, fixed field, and adjustable field sensor modes**, dark operate is active when the target is absent.

In light operate (LO) mode, the output is ON when the target returns the same or more light to the sensor and OFF when the sensor detects less light than the configured/taught target. In **opposed and retroreflective sensing modes**, light operate is active when the beam is unblocked. In **diffuse, fixed field, and adjustable field sensor modes**, light operate is active when the target is present.

1. Sensitivity adjustment
2. LEDs
 - Green LED: Power on indicator
 - Red LED: Signal indicator
 - Amber LED: Output status indicator
3. Optional LED signal strength display
4. Optional timing adjustment
5. Optional timing adjustment
6. Light/dark operate switch



Wiring Diagrams

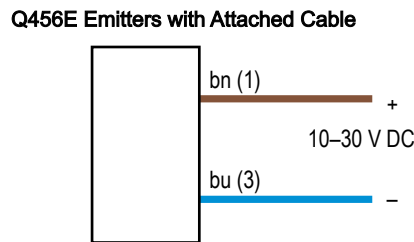
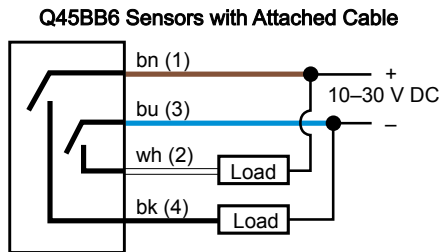

Key:
 1=Brown
 2=White
 3=Blue
 4=Black

4-pin Mini male quick disconnect

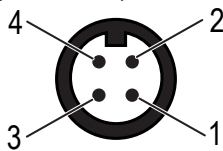

4-pin M12 male quick disconnect

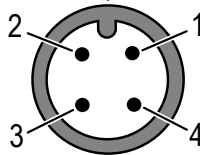

⁽²⁾ US patent no. 4356393

Specifications

Supply Voltage and Current

10 V DC to 30 V DC (10% maximum ripple), at less than 50 mA (exclusive of load)

Supply Protection Circuitry

Protected against reverse polarity and transient voltages

Output Configuration

Bipolar: one current sourcing (PNP) and one current sinking (NPN) open-collector transistor

Output Rating

250 mA maximum each output up to 50 °C, derated to 150 mA at 70 °C (derates 5 mA/°C)

Off-state leakage current less than 1 µA

Output saturation voltage (both outputs) less than 1 V at 10 mA and less than 2 V at 250 mA

Output Protection Circuitry

Protected against false pulse on power-up and continuous overload or short circuit of outputs

Output Response Time

Opposed mode: 2 milliseconds ON, 1 millisecond OFF

All other sensing modes: 2 milliseconds ON/OFF

NOTE: 100 millisecond delay on power-up. Output is non-conducting during this time.

Repeatability

Opposed mode: 0.25 milliseconds

All other sensing modes: 0.5 milliseconds

Response time and repeatability specifications are independent of signal strength.

Adjustments

Beneath the sensor's transparent cover: Light/Dark Operate select switch and multi-turn Sensitivity control (allows precise sensitivity setting – turn clockwise to increase gain). Optional logic and logic/display modules have adjustable timing functions (see ["Output Timing Logic and Signal Strength Display Modules" on page 9](#))

Indicators

Indicator LEDs are clearly visible beneath a raised transparent Lexan® dome on top of the sensor.

Power (green) LED lights whenever 10 V dc to 30V dc power is applied, and flashes to indicate output overload or output short circuit

Signal (red) AID™ System LED lights whenever the sensor sees its modulated light source, and pulses at a rate proportional to the strength of the received light signal

Load (amber) LED lights whenever the output is energized

Optional 7-element LED signal strength display modules

Construction

Molded reinforced thermoplastic polyester housing, o-ring-sealed transparent Lexan®⁽³⁾ cover, molded acrylic lenses, and stainless steel hardware. Designed to withstand 1200 psi washdown. The base of the cabled models has a ½-inch NPS integral internal conduit thread.

Connections

PVC-jacketed 2 m (6.5 ft) or 9 m (30 ft) cables, 4-pin Mini (Q suffix models), or 4-pin M12 (Q5 suffix models) quick-disconnect (QD) fittings are available. QD cables are ordered separately.

Application Notes

Optional output timing modules are available. See ["Output Timing Logic and Signal Strength Display Modules" on page 9](#).

Environmental Rating

NEMA 6, IP67

Operating Conditions

Temperature: –40 °C to +70 °C (–40 °F to +158 °F)

90% at +50 °C maximum relative humidity (non-condensing)

Certifications



Banner Engineering BV
Park Lane, Culliganlaan 2F bus 3
1831 Diegem, BELGIUM



Required Overcurrent Protection



WARNING: Electrical connections must be made by qualified personnel in accordance with local and national electrical codes and regulations.

Overcurrent protection is required to be provided by end product application per the supplied table.

Overcurrent protection may be provided with external fusing or via Current Limiting, Class 2 Power Supply.

Supply wiring leads < 24 AWG shall not be spliced.

For additional product support, go to www.bannerengineering.com.

Supply Wiring (AWG)	Required Overcurrent Protection (A)	Supply Wiring (AWG)	Required Overcurrent Protection (A)
20	5.0	26	1.0
22	3.0	28	0.8
24	2.0	30	0.5

⁽³⁾ Lexan® is a registered trademark of General Electric Co.

Q45BB6 Dimensions

Opposed, Retro, and Diffuse Sensing Modes (Model Suffix E, R, D, DL, DX, LP, and LV)

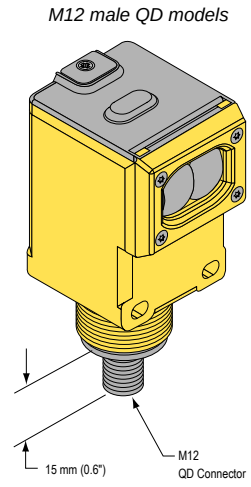
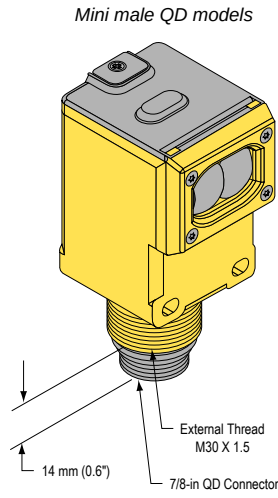
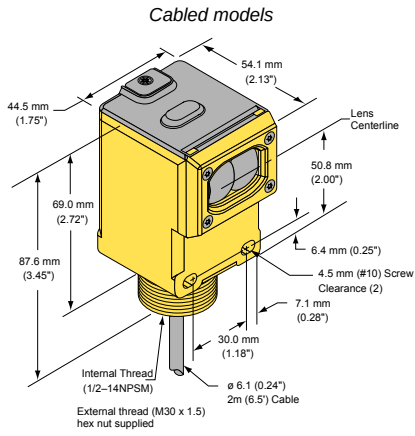

Convergent mode sensors (CV and CV4)

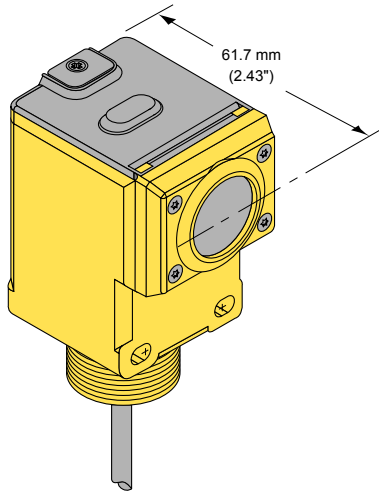

Glass fiberoptic models (F and FV)

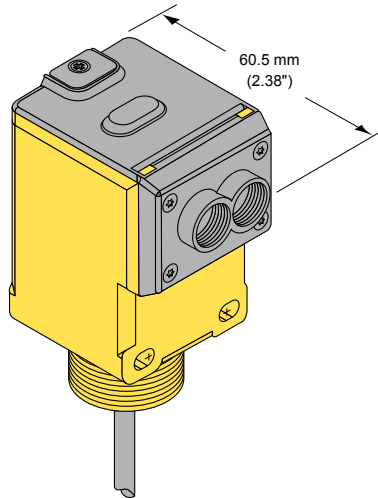

Plastic fiberoptic models (FP)

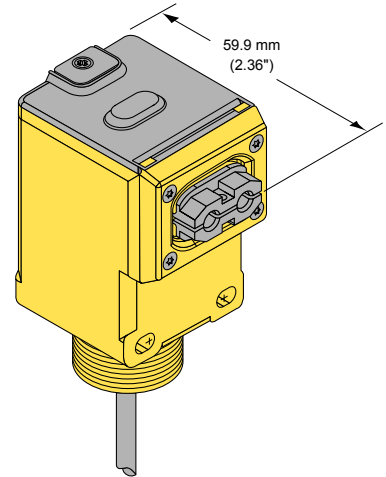

Q45BB6 Performance Curves

Opposed

Excess Gain

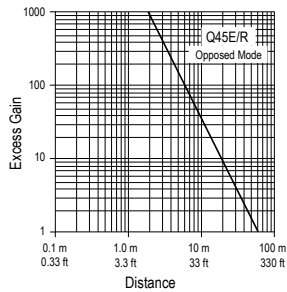

Beam Pattern

Effective Beam: 13 mm

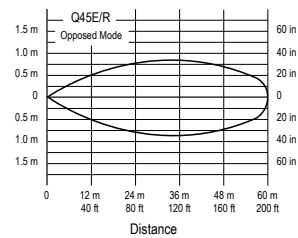

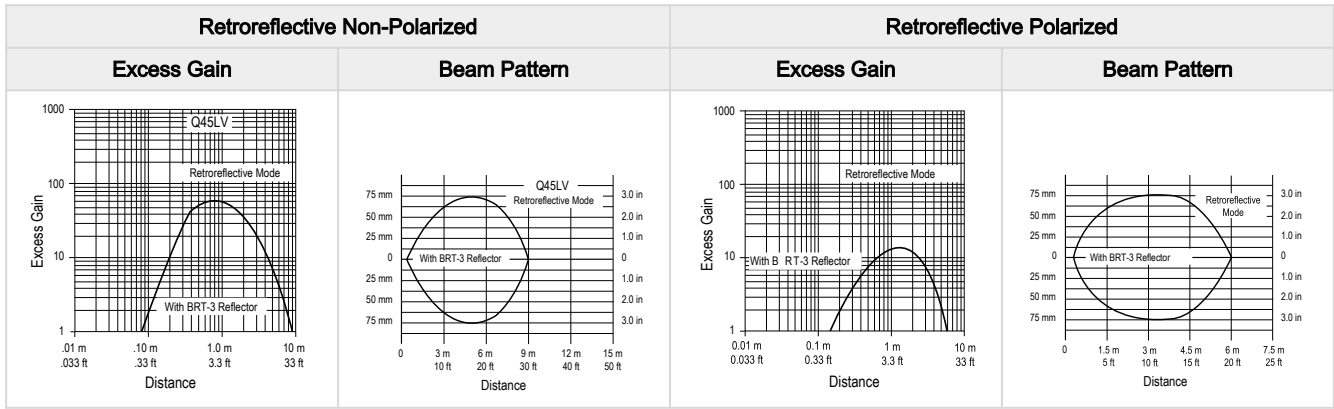

Diffuse-mode performance curves are based on a 90% reflectance white test card.

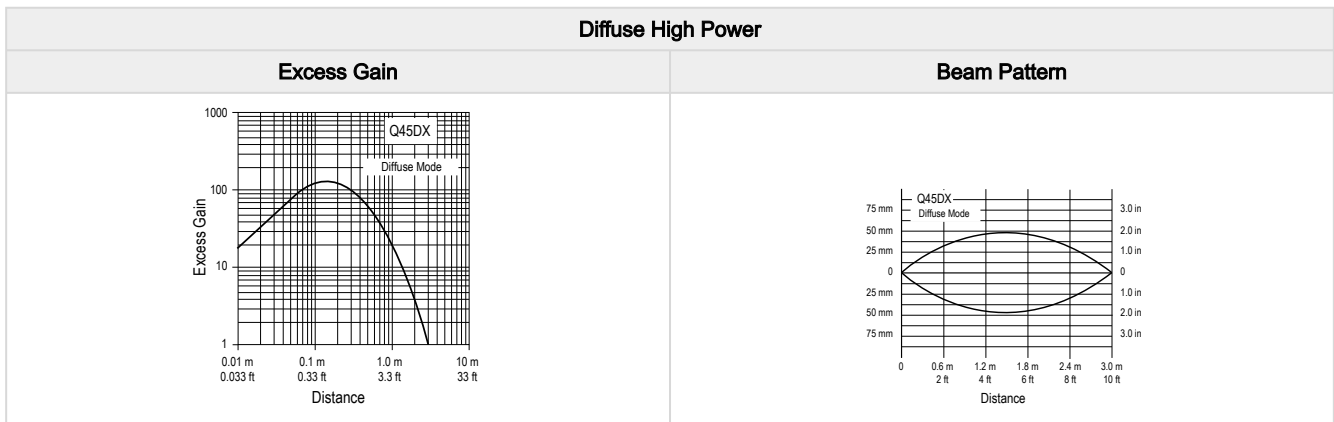
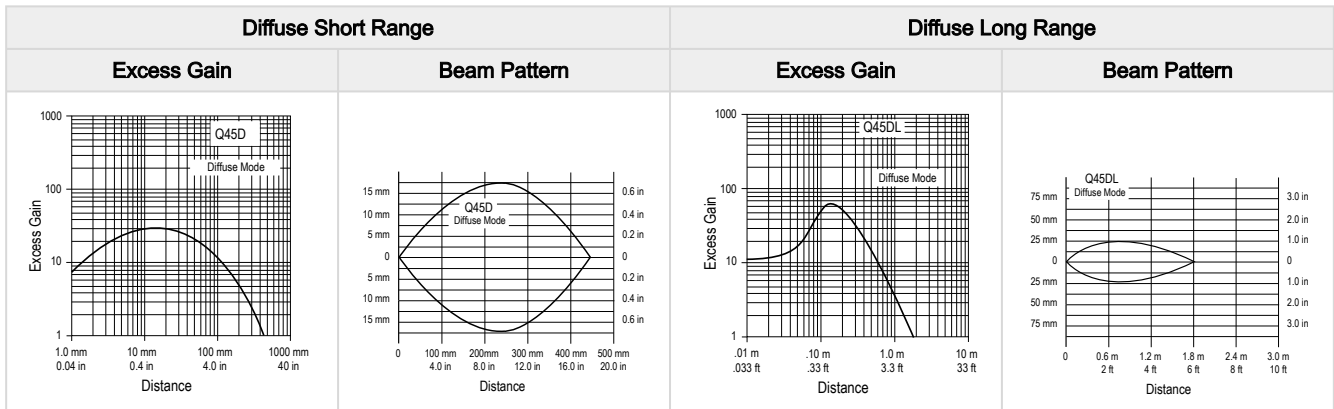

Convergent mode performance curves are based on a 90% reflectance white test card.

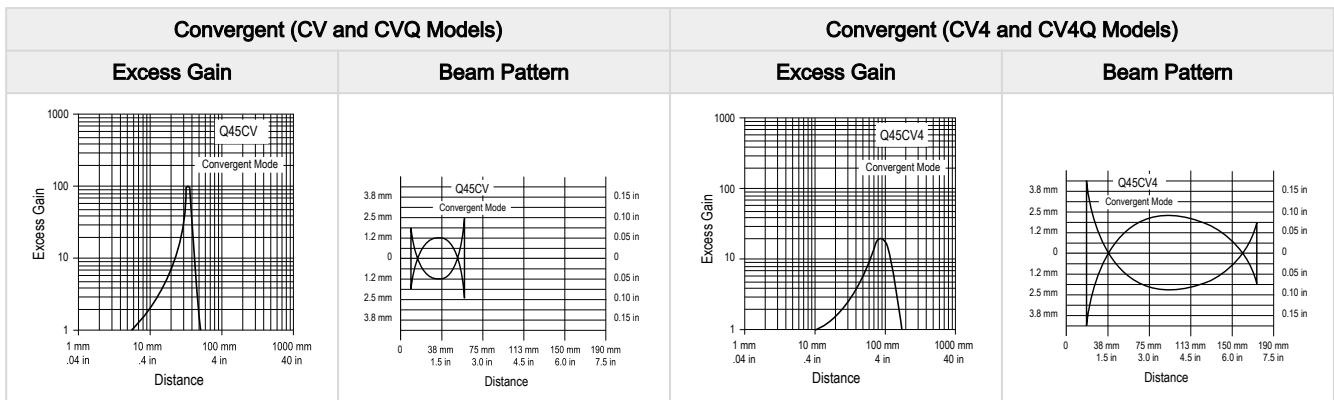

Glass fiber optic diffuse mode performance curves are based on a 90% reflectance white test card.

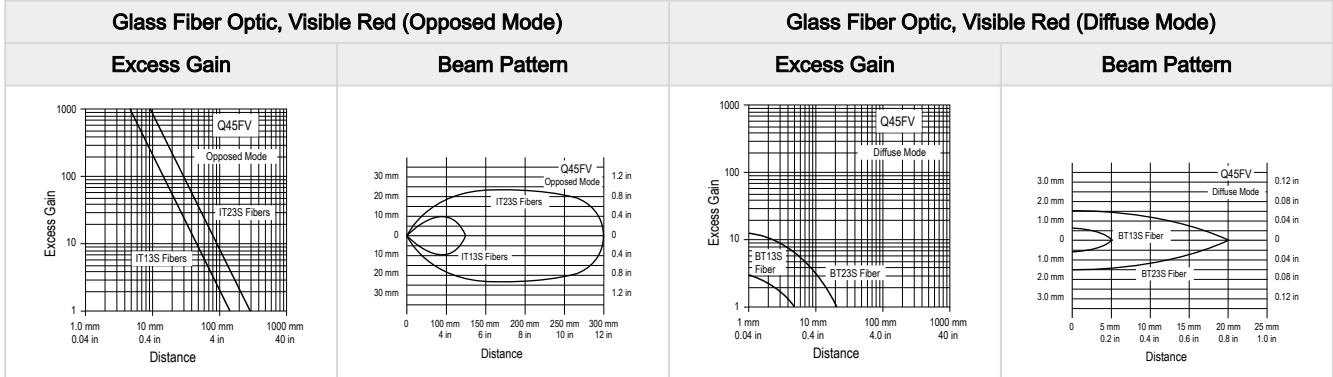
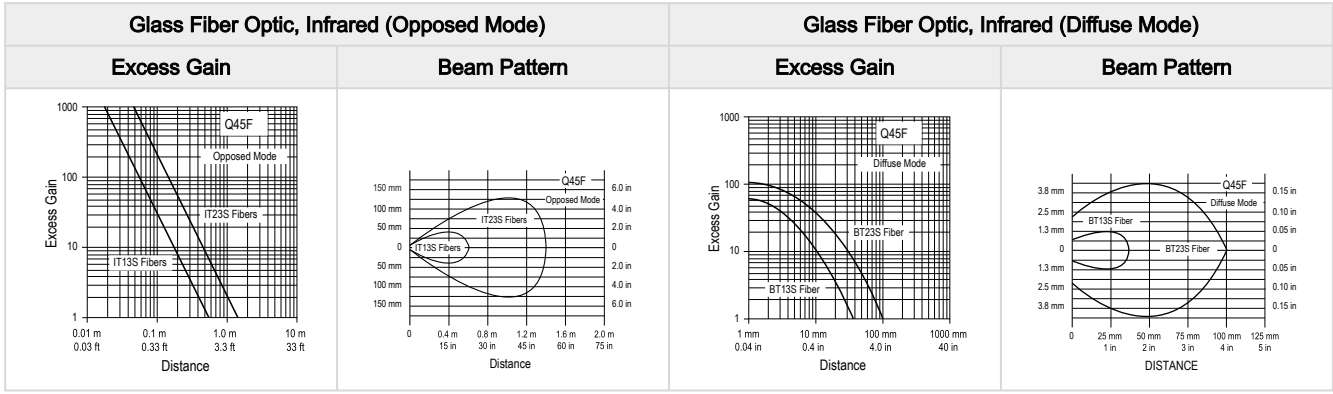

Plastic fiber optic Diffuse mode performance curves are based on a 90% reflectance white test card.

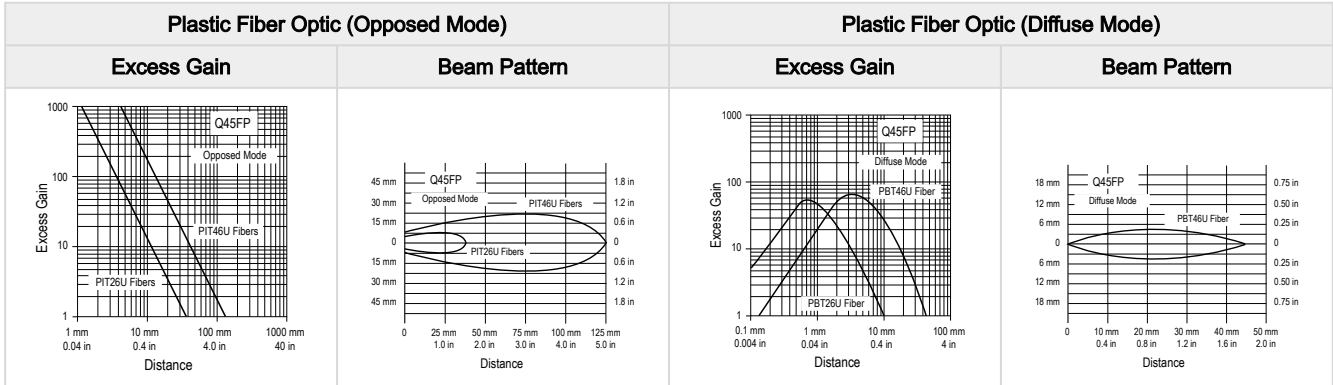

Q45BB6 Accessories



Cordsets

4-Pin Single-Ended M12 Female Cordsets					
Model	Length	Style	Dimensions	Pinout (Female)	
MQDC-403	1 m (3.28 ft)	Straight			1 = Brown 2 = White 3 = Blue 4 = Black 5 = Not used
MQDC-406	2 m (6.56 ft)				
MQDC-410	3 m (9.8 ft)				
MQDC-415	5 m (16.4 ft)				
MQDC-430	9 m (29.5 ft)				
MQDC-450	15 m (49.2 ft)				
MQDC-460	18.3 m (60 ft)				
MQDC-470	21 m (68.9 ft)				

Continued on page 9

Continued from page 8

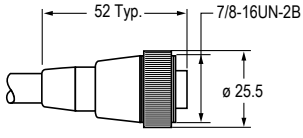
4-Pin Single-Ended M12 Female Cordsets				
Model	Length	Style	Dimensions	Pinout (Female)
MQDC-4100	30 m (98.43 ft)			

4-Pin Single-Ended Mini Female Cordsets				
Model	Length	Style	Dimensions	Pinout (Female)
MBCC-406	1.83 m (6 ft)	Straight		 <p>1 = Brown 2 = White 3 = Blue 4 = Black</p>
MBCC-412	3.66 m (12 ft)			
MBCC-430	9.14 m (30 ft)			

Retroreflective Targets

Banner offers a wide selection of high-quality retroreflective targets. See www.bannerengineering.com for complete information.

NOTE: Polarized sensors require corner cube-type retroreflective targets. Non-polarized sensors may use any retroreflective target.



Brackets

SMB30C

- 30 mm split clamp, black PBT bracket
- Stainless steel mounting hardware included
- Mounting hole for 30 mm sensor
- CAD Files: [DXF](#), [PDF](#), [IGS](#), [STP](#)

Hole center spacing: A=ø 45
Hole size: B=ø 27.2

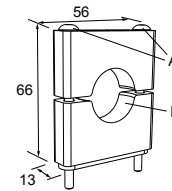

SMB30MM

- 12-gauge stainless steel bracket with curved mounting slots for versatile orientation
- Clearance for M6 (¼ in) hardware
- Mounting hole for 30 mm sensor
- CAD Files: [DXF](#), [PDF](#), [IGS](#), [STP](#)

Hole center spacing: A=51, A to B=25.4
Hole size: A=42.6 × 7, B=ø 6.4, C=ø 30.1

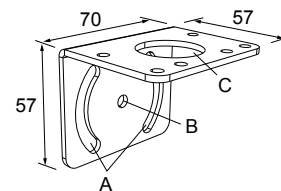

SMB30SC

- Swivel bracket with 30 mm mounting hole for sensor
- Black reinforced thermoplastic polyester
- Stainless steel mounting and swivel locking hardware included
- CAD Files: [DXF](#), [PDF](#), [IGS](#), [STP](#)

Hole center spacing: A=ø 50.8
Hole size: A=ø 7.0, B=ø 30.0

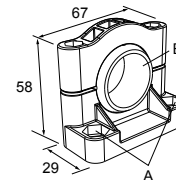

Output Timing Logic and Signal Strength Display Modules

Q45 sensors easily accept the addition of output timing logic and signal strength display functions. Display modules have a seven-element display that gives a more precise indication of excess gain than does the AID™ system LED that is standard on Q45 sensors. The modules listed below may be used with all Q45BB6 sensors. Refer to the module's datasheet for more information.

Models	Logic and/or Display Function
45LM58	Programmable output timing logic
45LM58D	Programmable output timing logic plus signal strength display
45LMD	Signal strength display only (no timing function)

Banner Engineering Corp Limited Warranty

Banner Engineering Corp. warrants its products to be free from defects in material and workmanship for one year following the date of shipment. Banner Engineering Corp. will repair or replace, free of charge, any product of its manufacture which, at the time it is returned to the factory, is found to have been defective during the warranty period. This warranty does not cover damage or liability for misuse, abuse, or the improper application or installation of the Banner product.

THIS LIMITED WARRANTY IS EXCLUSIVE AND IN LIEU OF ALL OTHER WARRANTIES WHETHER EXPRESS OR IMPLIED (INCLUDING, WITHOUT LIMITATION, ANY WARRANTY OF MERCHANTABILITY OR FITNESS FOR A PARTICULAR PURPOSE), AND WHETHER ARISING UNDER COURSE OF PERFORMANCE, COURSE OF DEALING OR TRADE USAGE.

This Warranty is exclusive and limited to repair or, at the discretion of Banner Engineering Corp., replacement. **IN NO EVENT SHALL BANNER ENGINEERING CORP. BE LIABLE TO BUYER OR ANY OTHER PERSON OR ENTITY FOR ANY EXTRA COSTS, EXPENSES, LOSSES, LOSS OF PROFITS, OR ANY INCIDENTAL, CONSEQUENTIAL OR SPECIAL DAMAGES RESULTING FROM ANY PRODUCT DEFECT OR FROM THE USE OR INABILITY TO USE THE PRODUCT, WHETHER ARISING IN CONTRACT OR WARRANTY, STATUTE, TORT, STRICT LIABILITY, NEGLIGENCE, OR OTHERWISE.**

Banner Engineering Corp. reserves the right to change, modify or improve the design of the product without assuming any obligations or liabilities relating to any product previously manufactured by Banner Engineering Corp. Any misuse, abuse, or improper application or installation of this product or use of the product for personal protection applications when the product is identified as not intended for such purposes will void the product warranty. Any modifications to this product without prior express approval by Banner Engineering Corp will void the product warranties. All specifications published in this document are subject to change; Banner reserves the right to modify product specifications or update documentation at any time. Specifications and product information in English supersede that which is provided in any other language. For the most recent version of any documentation, refer to: www.bannerengineering.com.

For patent information, see www.bannerengineering.com/patents.