

Q26 Luminescence Sensor

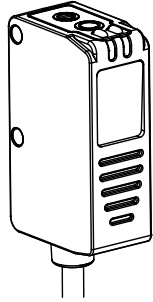

Datasheet

Q26 Luminescence Sensor for Luminescent Mark Detection



- Reliably detects luminescent plastics, coatings, lubricants, and other targets on even and uneven surfaces
- Simple configuration with the push button on the sensor's housing or via a remote input line
- Rotary switch selects Light Operate or Dark Operate
- IP67-rated housing for use in rugged industrial environments
- Compact housing size: 14 × 25 × 42 mm



WARNING: Not To Be Used for Personnel Protection

Never use this device as a sensing device for personnel protection. Doing so could lead to serious injury or death. This device does not include the self-checking redundant circuitry necessary to allow its use in personnel safety applications. A sensor failure or malfunction can cause either an energized or de-energized sensor output condition.

Models

| Model | Mode | Range | Output | Connector |
|-----------|-------------------------|----------------|--------|---|
| Q26PLUMQ5 | Diffuse Ultraviolet | 10 mm to 30 mm | PNP | 4-pin M12/Euro-style quick disconnect fitting on a 150 mm (6 in) PVC cable jacket |
| Q26NLUMQ5 | | | NPN | |

Mounting and Configuring the Luminescence Sensor

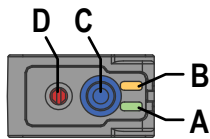

- A - Power LED (green)
- B - Output LED (amber)
- C - TEACH button
- D - DO / LO Rotary Selection (DO = fully clockwise; LO = fully counterclockwise)

1. Mount the luminescence sensor.
2. Align the luminescence sensor and the luminescent mark or luminescent target.
3. Select operating mode Light Operate or Dark Operate.
 - Turn the rotary switch (D) *counterclockwise* to select Light Operate if an output is desired when a luminescent mark (target) is present.
 - Turn the rotary switch (D) *clockwise* to select Dark Operate if an output is desired when a non-luminescent background is present.

TEACH Procedures

There are two ways to teach the Q26 Luminescence Sensor: press the TEACH button on the sensor or use a remote input line. The Q26 Luminescence Sensor has three TEACH procedures:

- Light SET
- Two-Point TEACH
- Dark SET



Light SET

1. Present the luminescent target and the sensor will set the threshold appropriately.

| Method | Action | Result |
|-------------------|---|---|
| TEACH Button | Position the luminescent target in front of the light spot emitted by the sensor. | Power LED: ON |
| Remote Input Line | | Output LED: depends on LO/DO selection, previous teach, and target. |

2. Teach the sensing condition.

| Method | Action | Result |
|-------------------|---|---|
| TEACH Button | Press and hold the TEACH button until the Power LED goes OFF, then release before the power LED turns ON again (less than 3 seconds). | Power LED: ON |
| Remote Input Line | Hold the remote wire high (to + V dc) until the Power LED goes OFF, then release before the power LED turns ON again (less than 3 seconds). | Output LED: ON (LO Mode), OFF (DO Mode) |

If the TEACH procedure was accepted, the Power LED turns ON and the sensor automatically returns to Run mode.

3. If the TEACH procedure was not accepted, the Power LED flashes and the Output LED is OFF. If the Power LED continues to flash, the TEACH procedure failed because of a low signal. Manually return the sensor to Run mode.

| Method | Action | Result |
|-------------------|---|---------------------------------|
| TEACH Button | Press and hold the TEACH button until the flashing Power LED turns solid green. | The sensor returns to Run mode. |
| Remote Input Line | Hold the remote input line high (to + V dc) until the flashing Power LED turns solid green. | |

As an alternative, follow the steps for Two-Point TEACH.

Two-Point TEACH Mode

Present both the luminescent mark and the background in two steps. The sensor will set the switching threshold between the two conditions and optimize its sensitivity.

1. Present the target.

| Method | Action | Result |
|-------------------|---|--|
| TEACH Button | Position the luminescent target in front of the light spot emitted by the sensor. | Power LED: ON |
| Remote Input Line | | Output LED: depends on LO/DO selection and target. |

2. Teach the sensing condition.

| Method | Action | Result |
|-------------------|---|-----------------|
| TEACH Button | Press and hold the TEACH button until the Power LED goes OFF, then ON (at least 3 seconds) and then release before the Power LED turns OFF again (less than 5 seconds). | Power LED: OFF |
| Remote Input Line | Hold the remote input wire high (to + V dc) until the Power LED goes OFF, then ON (at least 3 seconds) and then release before the Power LED turns OFF again (less than 5 seconds). | Output LED: OFF |

3. Present the background.

| Method | Action | Result |
|-------------------|---|-----------------|
| TEACH Button | Position the background in front of the light spot emitted by the sensor. | Power LED: OFF |
| Remote Input Line | | Output LED: OFF |

4. Teach the background condition.

| Method | Action | Result |
|-------------------|---|---|
| TEACH Button | Press the TEACH button (approximately 1 second), then release. | Power LED: ON |
| Remote Input Line | Hold the remote wire high (to + V dc) (approximately 1 second), then release. | Output LED: OFF (LO Mode), ON (DO Mode) If the TEACH procedure was accepted, the sensor automatically returns to Run mode. |

During the two-point TEACH procedure, if the luminescence signal is very weak, the sensor will increase its sensitivity by reducing its output response frequency from 2000 Hz to 500 Hz. The green LED blinks two times at the end of the TEACH procedure to indicate this has occurred.

- If the TEACH procedure was not accepted, the Power LED flashes and the Output LED is OFF. If the Power LED continues to flash, the TEACH procedure failed because of a low signal. Manually return the sensor to Run mode.

| Method | Action | Result |
|-------------------|---|---------------------------------|
| TEACH Button | Press and hold the TEACH button until the flashing Power LED turns solid green. | The sensor returns to Run mode. |
| Remote Input Line | Hold the remote input line high (to + V dc) until the flashing Power LED turns solid green. | Power LED is ON. |

As an alternative, try teaching the sensor using a different target.

Dark SET

- Sets the switching threshold for maximum sensitivity and a response speed of 2000 Hz. The sensor can be aligned at any target for this procedure.

| Method | Action | Result |
|-------------------|---|--|
| TEACH Button | Press and hold the TEACH button until the Power LED goes OFF, then ON (at 3 seconds) and continue holding for at least 5 seconds until the Power LED turns OFF again. | Power LED: ON |
| Remote Input Line | Hold the remote input line high (to + V dc) until the Power LED goes OFF, then ON (at 3 seconds) and continue holding for at least 5 seconds until the Power LED turns OFF again. | Output LED: depends on LO/DO selection and target. |

Performance Curves

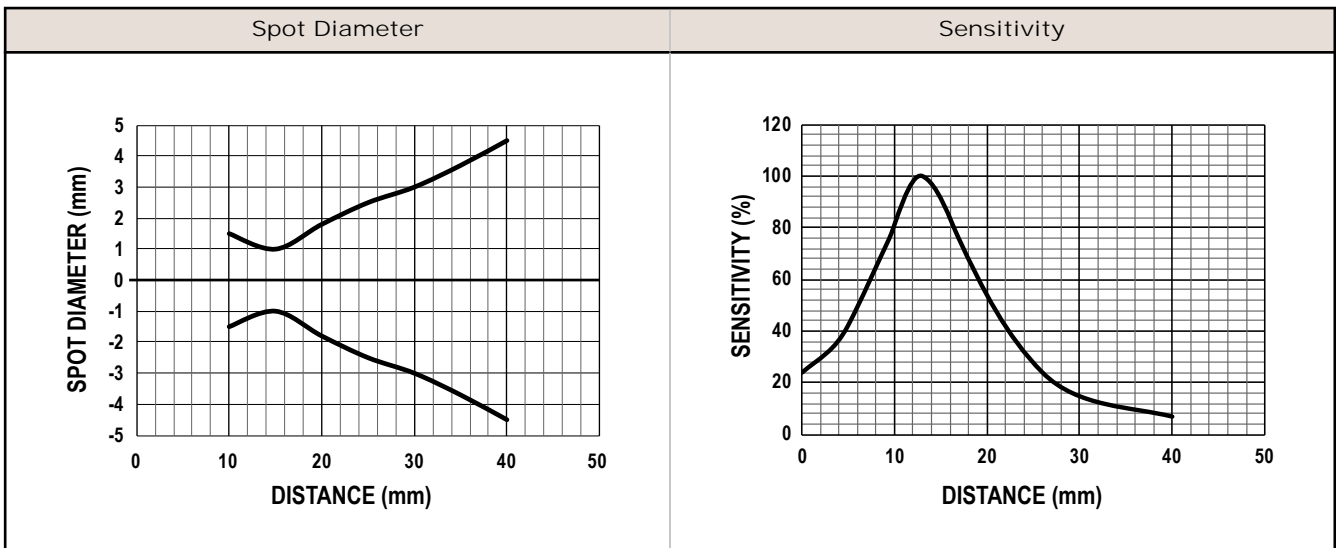

Specifications

Supply Voltage and Current
 12 to 30 V dc (2 Vpp maximum ripple)
 Supply Current (exclusive of load current): 30 mA

Supply Protection Circuitry
 Protected against reverse polarity and transient voltages

Sensing Range
 10 to 30 mm

Output Configuration
 NPN or PNP

Output Rating
 100 mA maximum (exclusive of load)
 ON-state saturation voltage: less than 2 V

Output Protection Circuitry
 Overload or short-circuit protection

Emitter LED Wavelength
 LED UV 375 nm

Emitter Beam Diameter
 2 mm at 15 mm

Environmental Rating
 IEC IP67

Operating Conditions
 -10 °C to +55 °C (+14 °F to +131 °F)

Storage Temperature
 -20 °C to +70 °C (-4 °F to +158 °F)

Vibration and Shock
 EN60068-2-6
 EN60068-2-27

Certifications



Output Response Time
 250 µs or 1 ms (based on sensitivity)

Output Switching Frequency
 2 kHz or 500 Hz (based on sensitivity)

Indicators
 Green on: Power ON
 Amber on: Output conducting

Adjustments
 LO/DO switch
 TEACH button
 Remote wire TEACH

Construction
 ABS plastic housing; glass window; polycarbonate lens

Connection
 4-pin M12/Euro-style quick disconnect fitting on a 150 mm (6 in) PVC cable jacket

Mounting
 Maximum torque 0.8 Nm (7 in. lbs.)

Required Overcurrent Protection



WARNING: Electrical connections must be made by qualified personnel in accordance with local and national electrical codes and regulations.

Overcurrent protection is required to be provided by end product application per the supplied table. Overcurrent protection may be provided with external fusing or via Current Limiting, Class 2 Power Supply. Supply wiring leads < 24 AWG shall not be spliced. For additional product support, go to <http://www.bannerengineering.com>.

| Supply Wiring (AWG) | Required Overcurrent Protection (Amps) |
|---------------------|--|
| 20 | 5.0 |
| 22 | 3.0 |
| 24 | 2.0 |
| 26 | 1.0 |
| 28 | 0.8 |
| 30 | 0.5 |

Dimensions

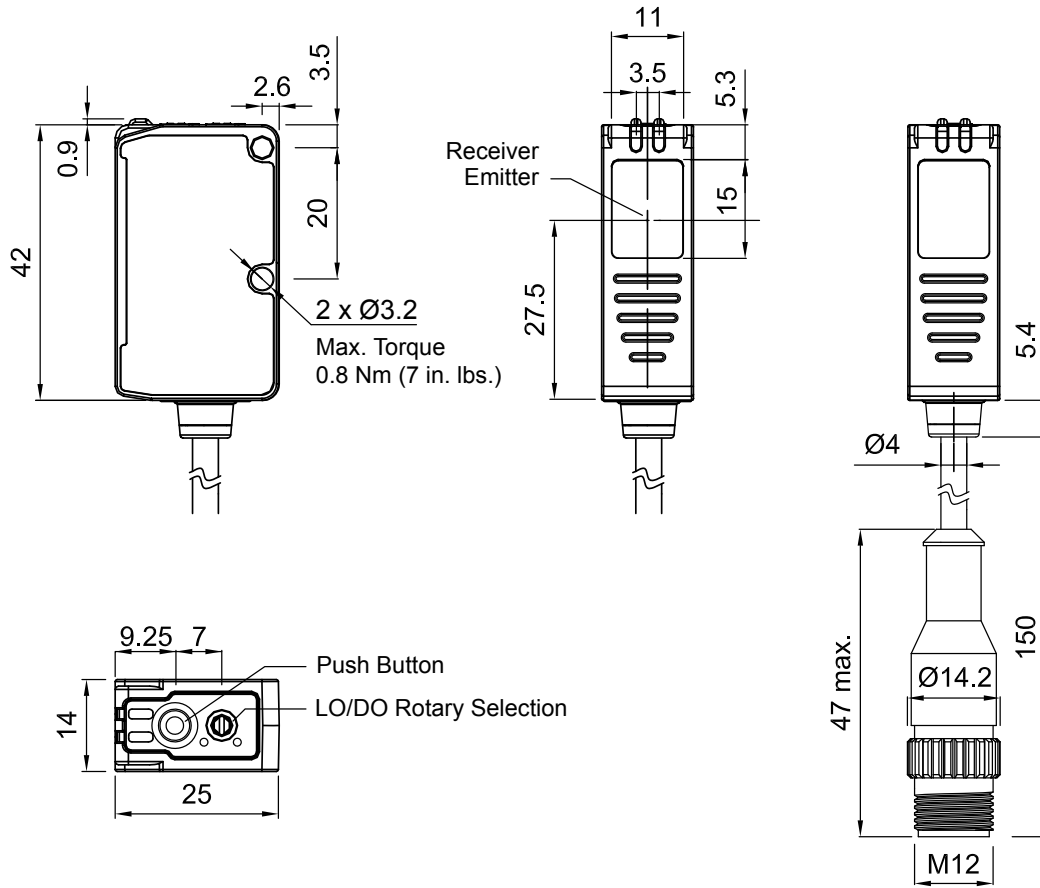

All measurements are listed in millimeters (inches), unless noted otherwise.

Wiring

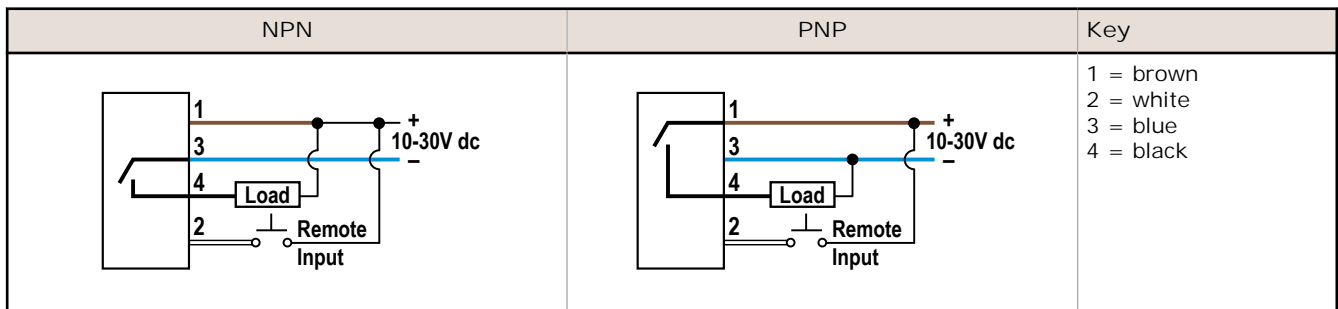

Accessories

Cordsets

| 4-Pin Threaded M12/Euro-Style Cordsets | | | | |
|--|----------------|-------------|------------|---|
| Model | Length | Style | Dimensions | Pinout (Female) |
| MQDC-406 | 1.83 m (6 ft) | Straight | | <p>1 = Brown 2 = White 3 = Blue 4 = Black</p> |
| MQDC-415 | 4.57 m (15 ft) | | | |
| MQDC-430 | 9.14 m (30 ft) | | | |
| MQDC-450 | 15.2 m (50 ft) | | | |
| MQDC-406RA | 1.83 m (6 ft) | Right-Angle | | |
| MQDC-415RA | 4.57 m (15 ft) | | | |
| MQDC-430RA | 9.14 m (30 ft) | | | |
| MQDC-450RA | 15.2 m (50 ft) | | | |

Brackets

All measurements are listed in millimeters, unless noted otherwise.

SMBLSTDLQ26

- Adjustable right-angle metal bracket
- 304 stainless steel

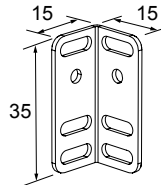

SMBLSTQ26

- Right-angle bracket
- 304 stainless steel

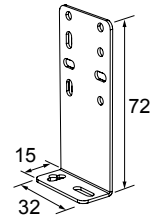

Banner Engineering Corp. Limited Warranty

Banner Engineering Corp. warrants its products to be free from defects in material and workmanship for one year following the date of shipment. Banner Engineering Corp. will repair or replace, free of charge, any product of its manufacture which, at the time it is returned to the factory, is found to have been defective during the warranty period. This warranty does not cover damage or liability for misuse, abuse, or the improper application or installation of the Banner product.

THIS LIMITED WARRANTY IS EXCLUSIVE AND IN LIEU OF ALL OTHER WARRANTIES WHETHER EXPRESS OR IMPLIED (INCLUDING, WITHOUT LIMITATION, ANY WARRANTY OF MERCHANTABILITY OR FITNESS FOR A PARTICULAR PURPOSE), AND WHETHER ARISING UNDER COURSE OF PERFORMANCE, COURSE OF DEALING OR TRADE USAGE.

This Warranty is exclusive and limited to repair or, at the discretion of Banner Engineering Corp., replacement. IN NO EVENT SHALL BANNER ENGINEERING CORP. BE LIABLE TO BUYER OR ANY OTHER PERSON OR ENTITY FOR ANY EXTRA COSTS, EXPENSES, LOSSES, LOSS OF PROFITS, OR ANY INCIDENTAL, CONSEQUENTIAL OR SPECIAL DAMAGES RESULTING FROM ANY PRODUCT DEFECT OR FROM THE USE OR INABILITY TO USE THE PRODUCT, WHETHER ARISING IN CONTRACT OR WARRANTY, STATUTE, TORT, STRICT LIABILITY, NEGLIGENCE, OR OTHERWISE.

Banner Engineering Corp. reserves the right to change, modify or improve the design of the product without assuming any obligations or liabilities relating to any product previously manufactured by Banner Engineering Corp.