

Features



Contact Factory for more information

- Rugged, cost-effective, and easy-to-install indicators available in K50, K50 Flat Pack, or K80 housing style
- Displays 5 colors and multiple flashing frequencies: steady ON, flashing, or alternating
- Illuminated dome provides easy-to-see operator guidance and indication of equipment status
- Compact devices are completely self-contained, no controller needed
- Choose NPN or PNP input, depending on model
- Immune to ambient light, EMI, and RFI interference
- 18 V DC to 30 V DC operation

Models

| Models | Construction | Connection | LED Function ⁽¹⁾ | Inputs |
|---------------|---|--|---|--------|
| K50LGRYBWPQ8 | 50 mm dome / 30 mm mount polycarbonate | Integral 8-pin M12 male quick-disconnect connector | 5 Color: Choose Green, Red, Yellow, Blue or White ON, flashing or alternating | PNP |
| K50LGRYBWNQ8 | | | | NPN |
| K50FLGRYBWPQ8 | 50 mm polycarbonate dome / polycarbonate base | | | PNP |
| K50FLGRYBWNQ8 | | | | NPN |
| K80LGRYBWPQ8 | 50 mm dome / Flat or DIN-mount polycarbonate | | | PNP |
| K80LGRYBWNQ8 | | | | NPN |

K50L and K50FL Models: Integral quick-disconnect connector models are listed.

- To order the 150 mm (6 in) PVC-jacketed cable with quick-disconnect connector models, replace **Q** in the model number with **QP** (example, **K50LGRYBWPQP8**).
- To order the 2 m (6.5 ft) cable models, omit the suffix **Q** from the model number (example, **K50LGRYBWP**).
- Models with a quick-disconnect connector require a mating cordset (see *Accessories*).

K80L Models: To order the terminal-wired models, omit the suffix **Q** from the model number (for example, **K80LGRYBWP**).

Wiring

| Function | PNP Wiring | NPN Wiring |
|----------------|------------|------------|
| Green on | | |
| Green flashing | | |
| Red on | | |
| Red flashing | | |

Continued on page 2

⁽¹⁾ Contact factory for other colors and color combinations.



Continued from page 1

| Function | PNP Wiring | NPN Wiring |
|---------------------------|------------|------------|
| Yellow on | | |
| Yellow flashing | | |
| Blue on | | |
| Blue flashing | | |
| White on | | |
| White flashing | | |
| Green, Red flash cycle | | |
| Green, Yellow flash cycle | | |
| Green, Blue flash cycle | | |
| Green, White flash cycle | | |
| Red, Yellow flash cycle | | |
| Red, Blue flash cycle | | |
| Red, White flash cycle | | |
| Yellow, Blue flash cycle | | |
| Yellow, White flash cycle | | |

Continued on page 3

Continued from page 2

| Function | PNP Wiring | NPN Wiring |
|----------------------------------|------------|------------|
| Blue, White flash cycle | | |
| Green, Red, Yellow flash cycle | | |
| Green, Red, Blue flash cycle | | |
| Green, Red, White flash cycle | | |
| Green, Yellow, Blue flash cycle | | |
| Green, Yellow, White flash cycle | | |
| Green, Blue, White flash cycle | | |
| Red, Yellow, Blue flash cycle | | |
| Red, Yellow, White flash cycle | | |
| Red, Blue, White flash cycle | | |
| Yellow, Blue, White flash cycle | | |

Continued on page 4

Continued from page 3

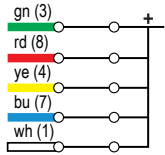
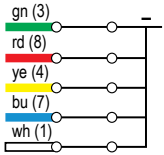
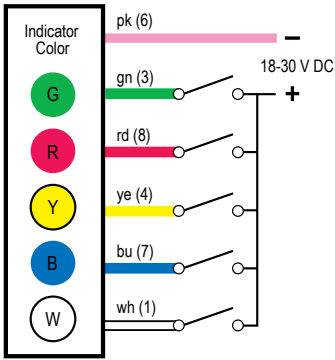
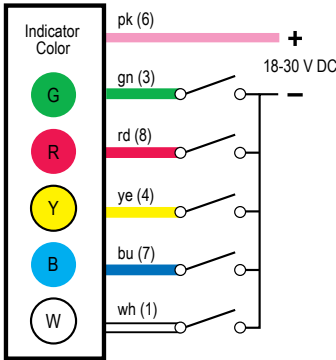
| Function | PNP Wiring | NPN Wiring |
|---|---|---|
| Green, Red, Yellow, Blue, White flash cycle |  |  |
| PNP | NPN | Wiring Key |
|  |  | <p>1 = White 2 = Brown (not used) 3 = Green 4 = Yellow 5 = Gray (not used) 6 = Pink 7 = Blue 8 = Red</p> |

Specifications

Supply Voltage and Current

18 V DC to 30 V DC at 50 mA maximum

Indicators

LEDs are independently selected: Green, Red, Yellow, Blue or White, ON steady or flashing, alternating or rotating

Input Response Time

Indicator ON: 250 ms (max.); Indicator OFF: 10 ms (max.)

Indicator Flash Rate

1-Color: 1 second flash rate (500 ms ON)
 2, 3 and 5-Color Flash: 500 ms per color

Environmental Rating

Rated IP67. K80L has encapsulated electronics only; other models fully encapsulated.

K50L and K50FL quick-disconnect connector models meet IP69K per ISO 20653.

Cabled models also meet IP69K if the cable and cable entrance are protected from high-pressure spray.

Connections

Integral 8-pin M12 male quick-disconnect connector, 150 mm (6 in) PVC-jacketed cable with an 8-pin M12 male quick-disconnect connector, or 2 m (6.5 ft) integral PVC-jacketed cable, depending on the model

K80L Models: Terminal-wired models for use with bulk cable available

Operating Conditions

-40 °C to +50 °C (-40 °F to +122 °F)

Certifications



Banner Engineering BV
 Park Lane, Culliganlaan 2F bus 3
 1831 Diegem, BELGIUM

Maximum intensity vs. viewing angle

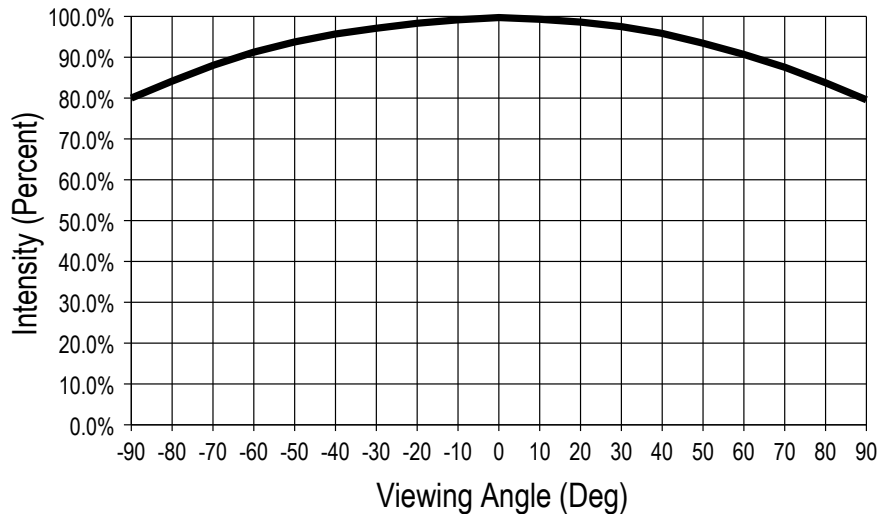

Dimensions

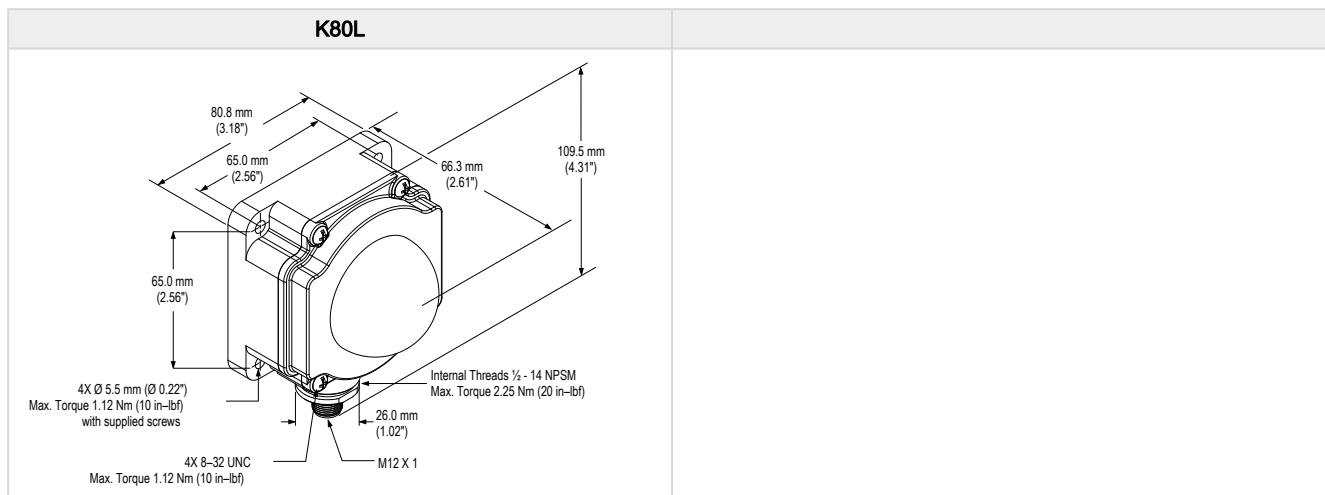
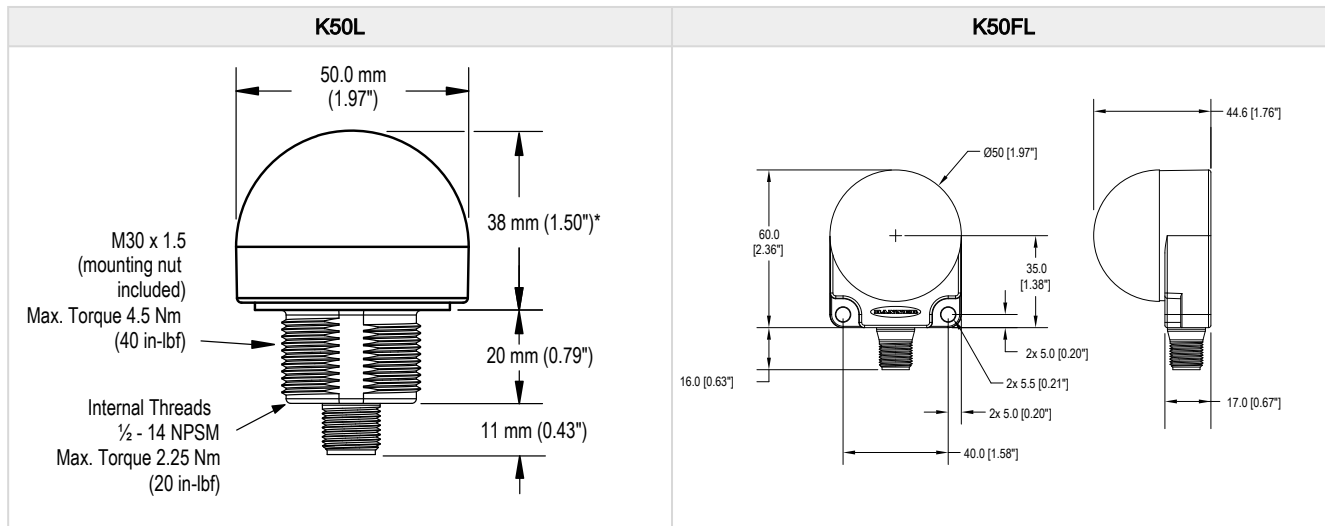

Accessories

Cordsets

| 8-Pin Single-Ended M12 Female Open-Shielded Cordsets | | | | |
|--|--------------------|-------------|------------|--|
| Model | Length | Style | Dimensions | Pinout (Female) |
| MQDC2S-806 | 2.04 m (6.7 ft) | Straight | | <p>1 = White 2 = Brown 3 = Green 4 = Yellow 5 = Gray 6 = Pink 7 = Blue 8 = Red</p> |
| MQDC2S-815 | 5.04 m (16.54 ft) | | | |
| MQDC2S-830 | 10.04 m (32.95 ft) | | | |
| MQDC2S-850 | 16 m (52.49 ft) | Right-Angle | | |
| MQDC2S-806RA | 2 m (6.56 ft) | | | |
| MQDC2S-815RA | 5 m (16.4 ft) | | | |
| MQDC2S-830RA | 10 m (32.81 ft) | | | |
| MQDC2S-850RA | 16 m (52.49 ft) | | | |

Brackets

Brackets for K80L models

SMBDX80DIN

- Black reinforced thermoplastic
- Bracket for mounting on a 35 mm DIN rail

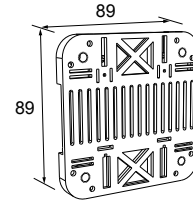

Brackets for K50L and K50FL models

SMB30A

- Right-angle bracket with curved slot for versatile orientation
- Clearance for M6 (¼ in) hardware
- Mounting hole for 30 mm sensor
- 12-gauge stainless steel

Hole center spacing: A to B=40

Hole size: A=ø 6.3, B= 27.1 × 6.3, C=ø 30.5

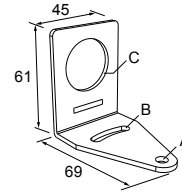

SMB30FA

- Swivel bracket with tilt and pan movement for precise adjustment
- Mounting hole for 30 mm sensor
- 12-gauge 304 stainless steel
- Easy sensor mounting to extrude rail T-slot
- Metric- and inch-size bolt available

Bolt thread: SMB30FA, A= 3/8 - 16 × 2 in; SMB30FAM10, A= M10 - 1.5 × 50

Hole size: B= ø 30.1

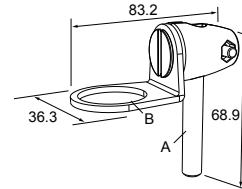

SMB30FVK

- V-clamp, flat bracket and fasteners for mounting to pipe or extensions
- Clamp accommodates 28 mm dia. tubing or 1 in. square extrusions
- 30 mm hole for mounting sensors

Hole size: A= ø 31

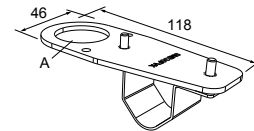

SMB30MM

- 12-gauge stainless steel bracket with curved mounting slots for versatile orientation
- Clearance for M6 (¼ in) hardware
- Mounting hole for 30 mm sensor

Hole center spacing: A = 51, A to B = 25.4

Hole size: A = 42.6 × 7, B = ø 6.4, C = ø 30.1

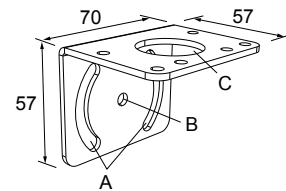

SMB30RAVK

- V-clamp, right-angle bracket and fasteners for mounting sensors to pipe or extrusion
- Clamp accommodates 28 mm dia. tubing or 1 in. square extrusions
- 30 mm hole for mounting sensors

Hole size: A = ø 30.5

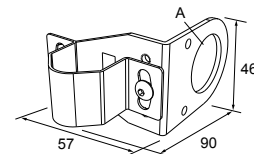

SMB30SC

- Swivel bracket with 30 mm mounting hole for sensor
- Black reinforced thermoplastic polyester
- Stainless steel mounting and swivel locking hardware included

Hole center spacing: A=∅ 50.8

Hole size: A=∅ 7.0, B=∅ 30.0

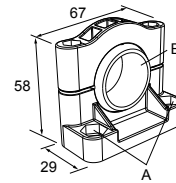
**SMBAMS30P**

- Flat SMBAMS series bracket
- 30 mm hole for mounting sensors
- Articulation slots for 90°+ rotation
- 12-gauge 300 series stainless steel

Hole center spacing: A=26.0, A to B=13.0

Hole size: A=26.8 × 7.0, B=∅ 6.5, C=∅ 31.0

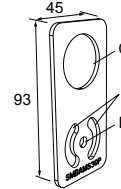
**SMBAMS30RA**

- Right-angle SMBAMS series bracket
- 30 mm hole for mounting sensors
- Articulation slots for 90°+ rotation
- 12-gauge (2.6 mm) cold-rolled steel

Hole center spacing: A=26.0, A to B=13.0

Hole size: A=26.8 × 7.0, B=∅ 6.5, C=∅ 31.0

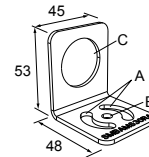

NOTE: K50FL models include a 48 mm (1.9 in) circular velcro mounting kit for easy mounting with no additional hardware.

Banner Engineering Corp Limited Warranty

Banner Engineering Corp. warrants its products to be free from defects in material and workmanship for one year following the date of shipment. Banner Engineering Corp. will repair or replace, free of charge, any product of its manufacture which, at the time it is returned to the factory, is found to have been defective during the warranty period. This warranty does not cover damage or liability for misuse, abuse, or the improper application or installation of the Banner product.

THIS LIMITED WARRANTY IS EXCLUSIVE AND IN LIEU OF ALL OTHER WARRANTIES WHETHER EXPRESS OR IMPLIED (INCLUDING, WITHOUT LIMITATION, ANY WARRANTY OF MERCHANTABILITY OR FITNESS FOR A PARTICULAR PURPOSE), AND WHETHER ARISING UNDER COURSE OF PERFORMANCE, COURSE OF DEALING OR TRADE USAGE.

This Warranty is exclusive and limited to repair or, at the discretion of Banner Engineering Corp., replacement. **IN NO EVENT SHALL BANNER ENGINEERING CORP. BE LIABLE TO BUYER OR ANY OTHER PERSON OR ENTITY FOR ANY EXTRA COSTS, EXPENSES, LOSSES, LOSS OF PROFITS, OR ANY INCIDENTAL, CONSEQUENTIAL OR SPECIAL DAMAGES RESULTING FROM ANY PRODUCT DEFECT OR FROM THE USE OR INABILITY TO USE THE PRODUCT, WHETHER ARISING IN CONTRACT OR WARRANTY, STATUTE, TORT, STRICT LIABILITY, NEGLIGENCE, OR OTHERWISE.**

Banner Engineering Corp. reserves the right to change, modify or improve the design of the product without assuming any obligations or liabilities relating to any product previously manufactured by Banner Engineering Corp. Any misuse, abuse, or improper application or installation of this product or use of the product for personal protection applications when the product is identified as not intended for such purposes will void the product warranty. Any modifications to this product without prior express approval by Banner Engineering Corp will void the product warranties. All specifications published in this document are subject to change; Banner reserves the right to modify product specifications or update documentation at any time. Specifications and product information in English supersede that which is provided in any other language. For the most recent version of any documentation, refer to: www.bannerengineering.com.

For patent information, see www.bannerengineering.com/patents.