

# Datasheet

Sona™ TI351

*Version 1.2*

---

# Product Notice

Date: May 5th, 2025

## Products Affected

Ezurio Part Number	Description
453-00199R	Module, Sona TI351, MHF4, Tape and Reel
453-00199C	Module, Sona TI351, MHF4, Cut Tape
453-00200R	Module, Sona TI351, Integrated Antenna, Tape and Reel
453-00200C	Module, Sona TI351, Integrated Antenna, Cut Tape
453-00209	Module, Sona TI351, M.2 2230

## Description of Changes

- The Sona TI351 family of products will receive an important product security update.
- The following changes will be made as part of the update:
  - Hardware configuration OTP setting
  - Radio firmware
  - Radio driver

## Reason for Change

- Ezurio is implementing a secure and enhanced software solution for the Sona TI351 that will include firmware protections that will prevent unauthorized firmware from operating on our radios.
- Support for scalability of long-term regulatory compliance.

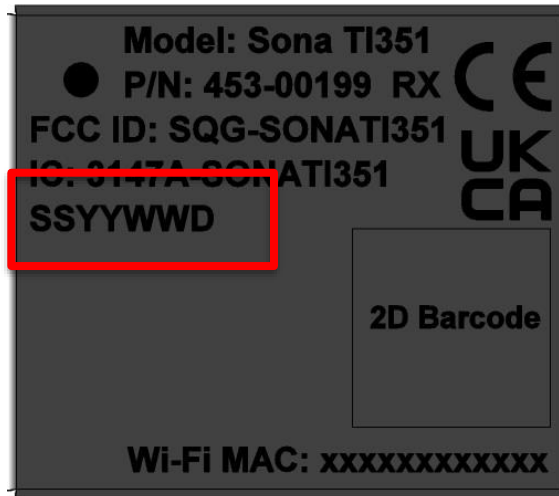
## Anticipated Impact of the Change

- Affected product will remain operational after the update. These devices are not compatible with the updated software.
- Effective from the launch of the enhanced hardware and software the currently shipped product will be depreciated as it will not be able to use the secure firmware.
- It is recommended but not mandated that any units being built with the current inventory are for evaluation purposes only and should be planned to be depreciated when the enhanced product has been released.
- The current revision of hardware should not be used for qualification of final product or samples to customers.
- Ezurio will replace any purchased modules with secure enhanced products when available.
- Availability of final production parts is scheduled for 3Q 2025.

## Method of Identifying the Affected Product

- Product labeled with the following date code are covered by this notice:

Date Code	1225025 or earlier
-----------	--------------------



## Contact Information

**Headquarters** Ezurio  
50 S Main St., Suite 1100  
Akron, OH 44308 USA  
Tel: 1(330) 434-7929  
Fax: 1(330) 434-7931

**Website** [www.ezurio.com](http://www.ezurio.com)

**Sales / Support Contact** <https://www.ezurio.com/contact>

*Product Change Notices (PCNs) will be distributed at the discretion of Ezurio. Occasionally, Ezurio may adjust product revision levels for internal tracking purposes only, and customers may not receive formal notifications associated with those revision changes.*

## Revision History

Version	Date	Notes	Contributors	Approver
0.1	Aug 20 2024	Preliminary release	Dave Neperud	Andy Ross
0.2	Sep 19 2024	Added shipping and labelling information for M.2 1216 module. Updated radio current values.	Dave Neperud	Andy Ross
1.0	Nov 5 2024	Initial release. Corrected UART pin out and COEX pin out to the M.2 standard. Added shipping and label information for the M.2 2230 module.	Dave Neperud	Andy Ross
1.1	Feb 28 2025	Additional implementation guidance on the SDIO_WAKE#/HOST_WL_IRQ line of the M.2 1216 modules in sections <a href="#">5.1</a> , <a href="#">5.2</a> , and <a href="#">12.1</a>	Dave Neperud	Andy Ross
1.2	May 6 2025	Added Product Notice at beginning of guide.	Dave Drogowski	Andy Ross

## Contents

1	Scope.....	7
2	Introduction.....	7
2.1	General Description.....	7
3	Sona TI351 Series Feature Summary .....	8
4	Block Diagrams.....	9
4.1	M.2 1216 Solder-Down LGA w/MHF4 connector .....	9
4.2	M.2 1216 Solder-Down LGA w/Chip Antenna .....	10
4.3	M.2 2230 Key-E card .....	11
5	Pin Definitions .....	12
5.1	Sona TI351 1216 MHF4 module Pin Assignments .....	12
5.2	Sona TI351 1216 Chip Antenna Pin Assignments .....	14
5.3	Sona TI351 M.2 2230 module Pin Assignments .....	16
6	Specifications .....	19
7	WLAN Functional Description.....	21
7.1	Overview .....	21
8	Bluetooth Functional Description .....	23
9	Electrical Characteristics .....	24
9.1	Absolute Maximum Ratings .....	24
9.2	Recommended Operating Conditions.....	24
9.3	DC Electrical Characteristics.....	24
9.4	Low Power States Current Consumption .....	25
9.5	WLAN Radio Receiver Characteristics .....	25
9.6	WLAN Transmitter Characteristics.....	26
9.7	Bluetooth Radio Characteristics.....	27
10	Slow Clock Oscillator Requirements .....	29
11	Host Interface Specifications .....	30
11.1	SDIO Specifications .....	30
11.1.1	Default mode .....	30
11.1.2	High Speed mode.....	30
11.2	UART Interface .....	31
11.3	Coexistence Feature.....	31
12	Power-Up Sequence and Requirements.....	31
12.1	M.2 1216 modules (453-00199 and 453-00200) .....	31
12.2	M.2 2230 module (453-00209) .....	31
13	Mechanical Specifications.....	32
13.1	M.2 1216 MHF4 Connector (453-00199) .....	32
13.2	M.2 1216 Chip Antenna PCB Footprint (453-00200) .....	33

13.3	M.2 1216 Module Dimensions .....	34
13.4	M.2 2230 Key-E (453-00209) .....	35
13.5	M.2 2230 Key-E Mounting .....	35
14	RF Layout Design Guidelines .....	37
14.1	Sona TI351 Integrated Antenna Guidelines .....	37
15	Application Notes .....	38
15.1	Introduction .....	38
15.2	Shipping and Labeling .....	38
15.2.1	M.2 1216 Solder-Down .....	38
15.2.2	M.2 2230 Key-E Card .....	42
15.3	Required Storage Conditions .....	45
15.3.1	Prior to Opening the Dry Packing .....	45
15.3.2	After Opening the Dry Packing .....	45
15.3.3	Temporary Storage Requirements after Opening .....	46
15.4	Baking Conditions .....	46
16	Surface Mount Conditions .....	47
16.1	Soldering .....	47
16.1.1	Cautions When Removing the M.2 1216 from the Platform for RMA .....	47
16.1.2	Precautions for Use .....	48
17	Reliability Test .....	49
17.1	Environmental and Mechanical .....	49
17.2	Reliability Prediction .....	50
18	Regulatory .....	51
18.1	Certified Antennas .....	51
18.2	Sona TI351 (453-00200) Chip Antenna Performance Characteristics .....	52
18.2.1	2442 MHz Radiated Performance .....	54
18.2.2	5500 MHz Radiated Performance .....	54
19	Additional Information .....	56

# 1 Scope

This document describes key hardware aspects of the Ezurio Sona™ TI351 series wireless modules providing a SDIO 2.0 interface for WLAN connection and a high-speed 4-wire UART interface for Bluetooth Low Energy (BLE)® connection. This document is intended to assist device manufacturers and related parties with the integration of this radio into their host devices.

**Note:** The information in this document is subject to change. Please contact Ezurio to obtain the most recent version of this document.

## 2 Introduction

### 2.1 General Description

The Sona TI351 series wireless module is an integrated, small form factor Wi-Fi/Bluetooth module that is optimized for low-power mobile devices, featuring:

- Wi-Fi 6: Dual-band 1x1 IEEE 802.11a/b/g/n/ax WLAN
- Bluetooth® 5.4: BLE

The integration of all WLAN and Bluetooth functionality in a single package supports a low cost and simple implementation along with flexibility for platform-specific customization. The radio is pre-calibrated and integrates the complete transmit/receive RF paths including bandpass filter, diplexer, switches, reference crystal oscillator, and power management units (PMU). It is available in both M.2 2230 E-Key and M.2 1216 solder-down form factors with an MHF4 antenna connector. The M.2 1216 module is also available with an integrated chip antenna variant. For a list of certified antennas see [Table 31](#) in this datasheet.

The Sona TI351 series device supports IEEE 802.11ax dual-band (2.4/5 GHz) single streams with data rates up to MCS7 (86 Mbps PHY data rate for 2.4/5 GHz). The fully integrated Wi-Fi and Bluetooth radios includes full digital MAC and baseband engines that handle all 802.11 CCK/OFDM/OFDMA® 2.4/5 GHz and Bluetooth Low Energy 5.4 baseband and protocol processing.

Ordering information is listed in [Table 1](#). Please contact Ezurio Sales/FAE for further information.

**Table 1: Product ordering information**

Part Number	Description
453-00199R	Module, Sona TI351, 1216, MHF4L, Tape and Reel
453-00199C	Module, Sona TI351, 1216, MHF4L, Cut Tape
453-00200R	Module, Sona TI351, 1216, Chip Antenna, Tape and Reel
453-00200C	Module, Sona TI351, 1216, Chip Antenna, Cut Tape
453-00209	Module, Sona TI351, M.2, Key E, MHF4L, SDIO, UART
453-00200-K1	Development Kit, Module, Sona TI351, Chip Antenna, SDIO, UART

### 3 Sona TI351 Series Feature Summary

The Ezurio Sona TI351 series device features are summarized in [Table 2](#).

**Table 2: Sona TI351 series wireless module key features**

Feature	Description
<b>Wi-Fi Radio</b>	<ul style="list-style-type: none"> <li>• IEEE 802.11a/b/g/n/ax, dual-band capable, (2.4/5GHz) single antenna port</li> <li>• 1x1 SISO 20MHz wide channel bandwidth, providing up to 86 Mbps (64-QAM)</li> <li>• Supports OFDMA, Trigger frame, MU-MIMO (downlink), Basic Service Set (BSS) Coloring, and Target wake time (TWT - station only)</li> <li>• Multirole support</li> <li>• Hardware based WPA2 and WPA3 security</li> <li>• Integrated RF power amplifier with up to +20dBm of transmit power</li> <li>• Integrated LNA and T/R switches</li> <li>• Shared antenna connection with BLE using integrated coexistence engine</li> </ul>
<b>Bluetooth Low Energy Radio</b>	<ul style="list-style-type: none"> <li>• Bluetooth 5.4 (Bluetooth LE) certified</li> <li>• Bluetooth LE 2 Mbps</li> <li>• Bluetooth LE long range (125/500 kbps)</li> <li>• Bluetooth LE advertising extensions for improved capacity</li> </ul>
<b>Host Interfaces</b>	<ul style="list-style-type: none"> <li>• Wi-Fi section provides support for SDIO v2.0</li> <li>• Host Controller interface (HCI) for BLE radio using HS-UART</li> </ul>
<b>Package Options</b>	<ul style="list-style-type: none"> <li>• M.2 1216 96 Pin LGA - 12mm x 16mm x 1.75mm</li> <li>• M.2 2230 75 Pin Key-E module - 22mm x 30mm x 2.55mm (MHF4L connector only)</li> </ul>
<b>Operating Characteristics</b>	<ul style="list-style-type: none"> <li>• Supply Voltage 1216 Modules: 3.3VDC (RF PA supply) and 1.8VDC (Main &amp; I/O supply)</li> <li>• Supply Voltage M.2 2230 module: 3.3VDC</li> <li>• Operating Temperature: -40°C to 85°C</li> <li>• Storage Temperature: -55°C to 125°C</li> </ul>

## 4 Block Diagrams

### 4.1 M.2 1216 Solder-Down LGA w/MHF4 connector

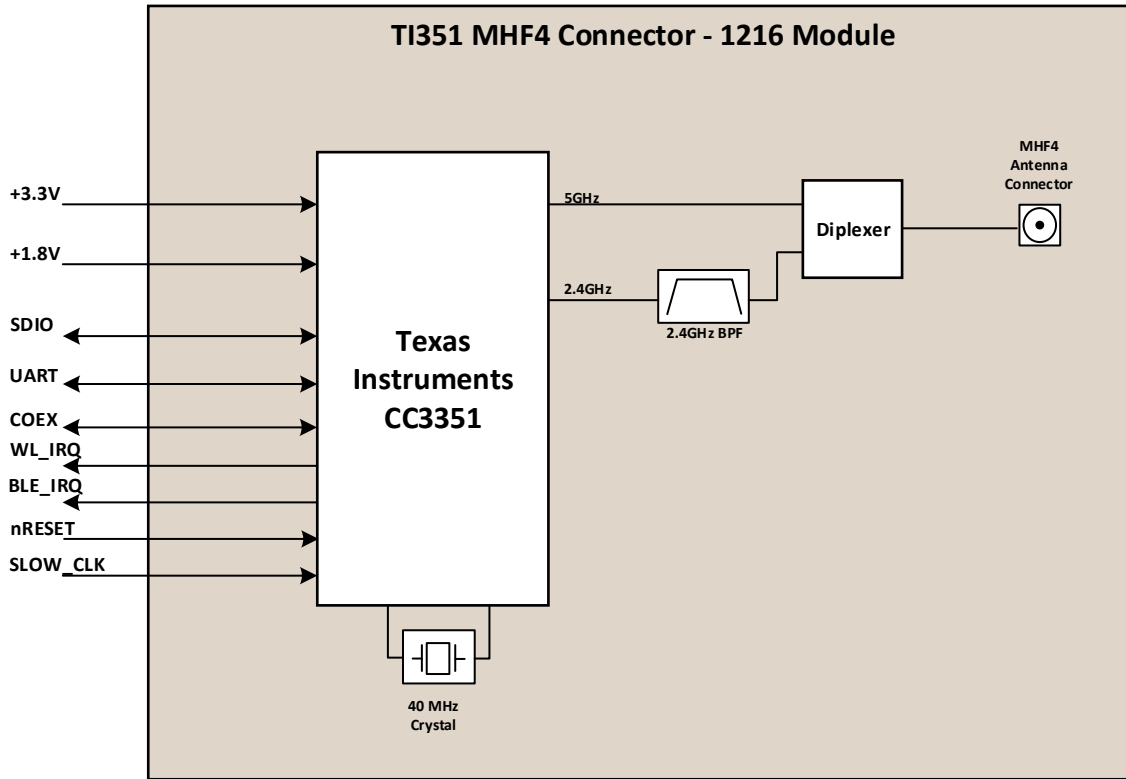


Figure 1: M.2 1216 MHF4L connector variant (453-00199) block diagram

**4.2 M.2 1216 Solder-Down LGA w/Chip Antenna**

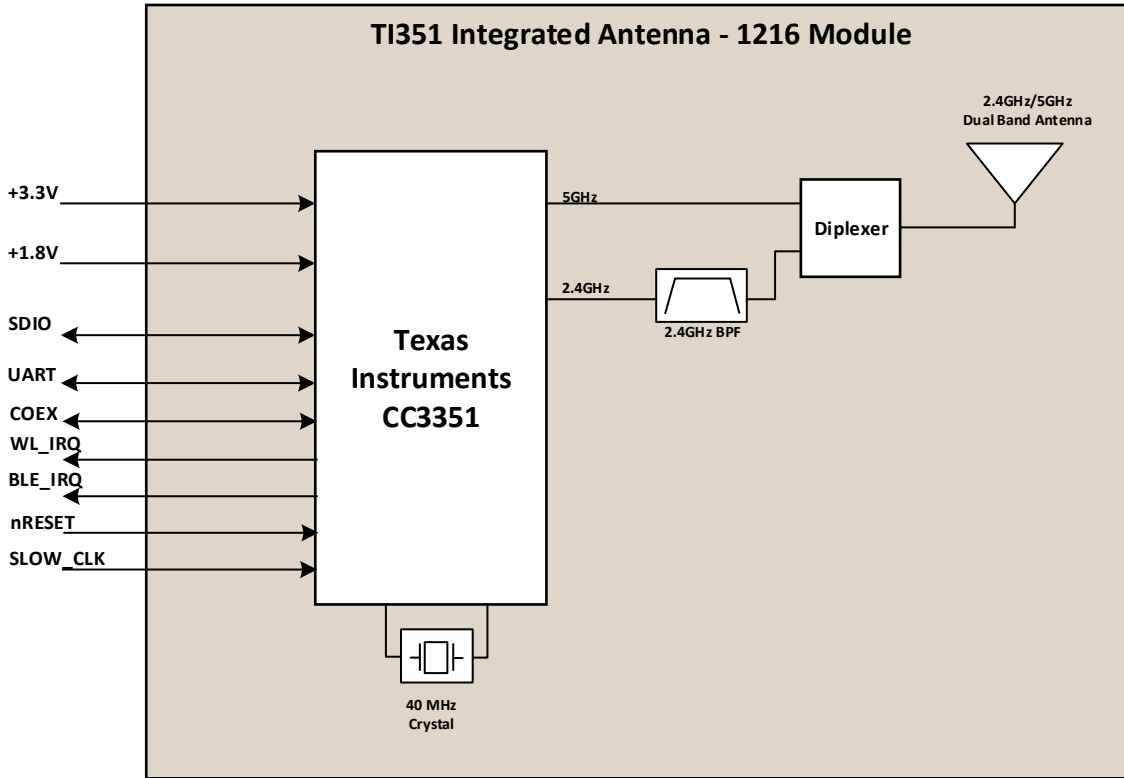


Figure 2: M.2 1216 Chip Antenna variant (453-00200) block diagram

**4.3 M.2 2230 Key-E card**

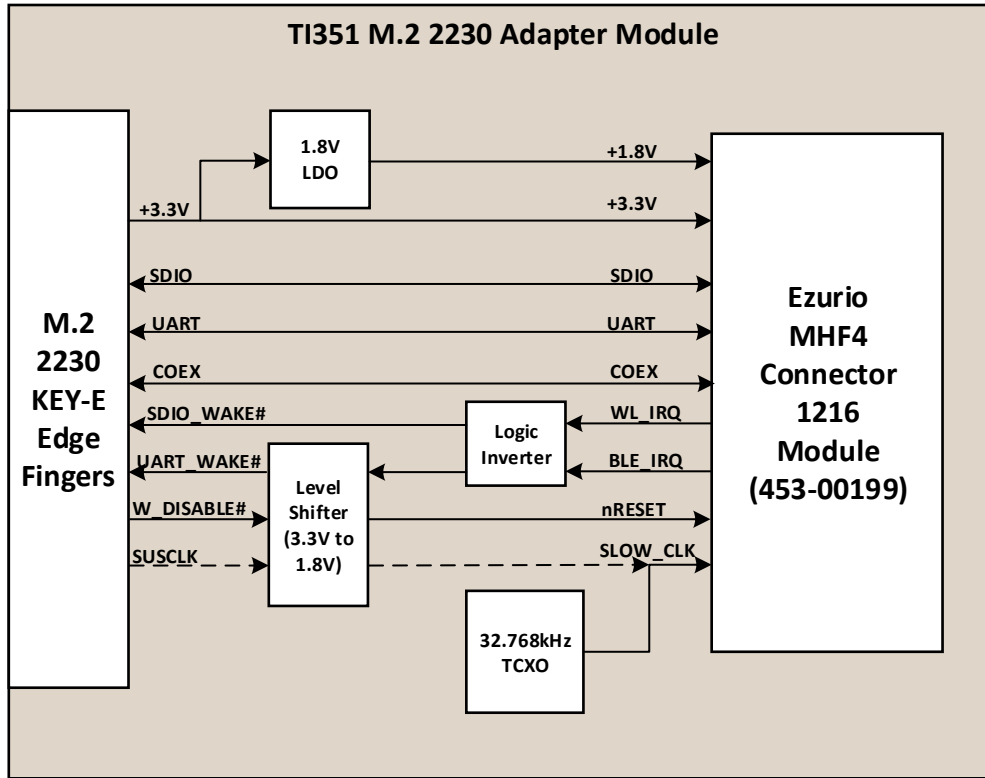


Figure 3: M.2 2230 Key-E card (453-00209) block diagram

## 5 Pin Definitions

### 5.1 Sona TI351 1216 MHF4 module Pin Assignments

Table 3: 453-00199 pinout and naming

Pin #	Name	Type	Voltage Ref	Function	Comment
1 - 3	-	-	-	UNUSED	NC
4	3.3V	PWR	3.3V	DC Supply for RF Power Amplifier.	-
5	3.3V	PWR	3.3V	DC Supply for RF Power Amplifier.	-
6	GND	-	-	Ground	GND
7 - 10	-	-	-	UNUSED	NC
11	COEX1_RXD/COEX_REQ	I	1.8V	External Coexistence Interface	NC if Unused
12	COEX2_TXD/COEX_GRANT	O	1.8V	External Coexistence Interface	NC if Unused
13	COEX3/COEX_PRIORITY	I	1.8V	External Coexistence Interface	NC if Unused
14 - 16	-	-	-	UNUSED	NC
17	GND	-	-	Ground	GND
18 - 19	-	-	-	UNUSED	NC
20	GND	-	-	Ground	GND
21 - 22	-	-	-	UNUSED	NC
23	GND	-	-	Ground	GND
24 - 25	-	-	-	UNUSED	NC
26	GND	-	-	Ground	GND
27	SUSCLK/SLOW_CLK_IN	I	1.8V	External sleep clock (32.768kHz)	NC if Unused
28	W_DISABLE1#/nRESET	I	1.8V	Reset line for enabling/disabling device (active low)	Hold low for >10µs after power inputs stabilized
29 - 31	-	-	-	UNUSED	NC
32	GND	-	-	Ground	GND
33 - 34	-	-	-	UNUSED	NC
35	GND	-	-	Ground	GND
36 - 37	-	-	-	UNUSED	NC
38	GND	-	-	Ground	GND
39 - 40	-	-	-	UNUSED	NC
41	GND	-	-	Ground	GND
42 - 45	-	-	-	UNUSED	NC
46	SDIO_WAKE#/HOST_IRQ_WL <b>Important Design Note</b> <sup>[1]</sup>	O	1.8V	Host Wake signal Required for Wake on Wireless	Active High Interrupt <sup>[2]</sup>
47	SDIO_DATA3	I/O	1.8V	SDIO Data Line 3	
48	SDIO_DATA2	I/O	1.8V	SDIO Data Line 2	
49	SDIO_DATA1	I/O	1.8V	SDIO Data Line 1	

Pin #	Name	Type	Voltage Ref	Function	Comment
50	SDIO_DATA0	I/O	1.8V	SDIO Data Line 0	
51	SDIO_CMD	I/O	1.8V	SDIO Command Line	
52	SDIO_CLK	I	1.8V	SDIO Clock Input	
53	UART_WAKE#/HOST_IRQ_BLE	O	1.8V	Host Wake signal (Shared SDIO mode)	Active High Interrupt <sup>[2]</sup>
54	UART_CTS	I	1.8V	BLE HCI UART clear to send	
55	UART_TXD	O	1.8V	BLE HCI UART serial output	
56	UART_RXD	I	1.8V	BLE HCI UART serial input	
57	UART_RTS	O	1.8V	BLE HCI UART request to send	
58 - 61	-	-	-	UNUSED	NC
62	GND	-	-	Ground	GND
63 - 65	-	-	-	UNUSED	NC
66	VIO_1.8V	PWR	1.8V	DC Supply for module I/O and main	-
67	-	-	-	UNUSED	NC
68	GND	-	-	Ground	GND
69 - 70	-	-	-	UNUSED	NC
71	GND	-	-	Ground	GND
72	3.3V	PWR	3.3V	DC Supply for RF Power Amplifier.	-
73	3.3V	PWR	3.3V	DC Supply for RF Power Amplifier.	-
74	GND	-	-	Ground	GND
75	GND	-	-	Ground	GND
76	-	-	-	UNUSED	NC
77 - 80	GND	-	-	Ground	GND
81	-	-	-	UNUSED	NC
82 - 85	GND	-	-	Ground	GND
86	-	-	-	UNUSED	NC
87 - 91	GND	-	-	Ground	GND
92	-	-	-	UNUSED	NC
93 - 96	GND	-	-	Ground	GND
G1 - G12	GND	-	-	Ground	GND

**Important Notes:** 1. The SDIO\_WAKE#/HOST\_IRQ\_WL line on the M.2 1216 module is sensed by the module on power up. The pin is pulled low internally and must remain low when the device powers up. **When this pin is connected to a host device, ensure that the line stays at a logic low level during module power-up and is not pulled high or driven high by the host platform.** Some host implementations may require a buffer device to be placed between the SDIO\_WAKE#/HOST\_IRQ\_WL module pin and the MCU GPIO pin used depending on how the MCU configures the GPIO on power up.

2. Interrupts are active high and need an external inverter to conform to M.2 1216 LGA specification.

## 5.2 Sona TI351 1216 Chip Antenna Pin Assignments

Table 4: 453-00200 Pinout and naming

Pin #	Name	Type	Voltage Ref	Function	Comment
1 - 3	-	-	-	UNUSED	NC
4	3.3V	PWR	3.3V	DC Supply for RF Power Amplifier.	-
5	3.3V	PWR	3.3V	DC Supply for RF Power Amplifier.	-
6	GND	-	-	Ground	GND
7 - 10	-	-	-	UNUSED	NC
11	COEX1_RXD/COEX_REQ	I	1.8V	External Coexistence Interface	NC if Unused
12	COEX2_TXD/COEX_GRANT	O	1.8V	External Coexistence Interface	NC if Unused
13	COEX3/COEX_PRIORITY	I	1.8V	External Coexistence Interface	NC if Unused
14 - 16	-	-	-	UNUSED	NC
17	GND	-	-	Ground	GND
18 - 19	-	-	-	UNUSED	NC
20	GND	-	-	Ground	GND
21 - 22	-	-	-	UNUSED	NC
23	GND	-	-	Ground	GND
24 - 25	-	-	-	UNUSED	NC
26	GND	-	-	Ground	GND
27	SUSCLK/SLOW_CLK_IN	I	1.8V	External sleep clock (32.768kHz)	NC if Unused
28	W_DISABLE1#/nRESET	I	1.8V	Reset line for enabling/disabling device (active low)	Hold low for >10μs after power inputs stabilized
29 - 31	-	-	-	UNUSED	NC
32	GND	-	-	Ground	GND
33 - 34	-	-	-	UNUSED	NC
35	GND	-	-	Ground	GND
36 - 37	-	-	-	UNUSED	NC
38	GND	-	-	Ground	GND
39 - 40	-	-	-	UNUSED	NC
41	GND	-	-	Ground	GND
42 - 45	-	-	-	UNUSED	NC
46	SDIO_WAKE#/HOST_IRQ_WL <b>Important Design Note<sup>[1]</sup></b>	O	1.8V	Host Wake signal Required for Wake on Wireless	Active High Interrupt <sup>[2]</sup>
47	SDIO_DATA3	I/O	1.8V	SDIO Data Line 3	
48	SDIO_DATA2	I/O	1.8V	SDIO Data Line 2	
49	SDIO_DATA1	I/O	1.8V	SDIO Data Line 1	
50	SDIO_DATA0	I/O	1.8V	SDIO Data Line 0	
51	SDIO_CMD	I/O	1.8V	SDIO Command Line	

Pin #	Name	Type	Voltage Ref	Function	Comment
52	SDIO_CLK	I	1.8V	SDIO Clock Input	
53	UART_WAKE#/HOST_IRQ_BLE	O	1.8V	Host Wake signal (Shared SDIO mode)	Active High Interrupt <sup>[2]</sup>
54	UART_CTS	I	1.8V	BLE HCI UART clear to send	
55	UART_TXD	O	1.8V	BLE HCI UART serial output	
56	UART_RXD	I	1.8V	BLE HCI UART serial input	
57	UART_RTS	O	1.8V	BLE HCI UART request to send	
58 – 61	-	-	-	UNUSED	NC
62	GND	-	-	Ground	GND
63 – 65	-	-	-	UNUSED	NC
66	VIO_1.8V	PWR	1.8V	DC Supply for module I/O and main	-
67	-	-	-	UNUSED	NC
68	GND	-	-	Ground	GND
69 – 70	-	-	-	UNUSED	NC
71	GND	-	-	Ground	GND
72	3.3V	PWR	3.3V	DC Supply for RF Power Amplifier.	-
73	3.3V	PWR	3.3V	DC Supply for RF Power Amplifier.	-
74	GND	-	-	Ground	GND
75	GND	-	-	Ground	GND
76	-	-	-	UNUSED	NC
G1 – G4, G6 – G8, G10 – G12	GND	-	-	Ground	GND

**Important Notes:** 1. The SDIO\_WAKE#/HOST\_IRQ\_WL line on the M.2 1216 module is sensed by the module on power up. The pin is pulled low internally and must remain low when the device powers up. **When this pin is connected to a host device, ensure that the line stays at a logic low level during module power-up and is not pulled high or driven high by the host platform.** Some host implementations may require a buffer device to be placed between the SDIO\_WAKE#/HOST\_IRQ\_WL module pin and the MCU GPIO pin used depending on how the MCU configures the GPIO on power up.

2. Interrupts are active high and need an external inverter to conform to M.2 1216 LGA specification.

### 5.3 Sona TI351 M.2 2230 module Pin Assignments

Table 5: 453-00209 Pinout and naming

Pin#	M.2 Signal Name	Type	Voltage Ref	TI351 Function	Comment
1	GND	-	-	Ground	GND
2	3.3V	PWR	3.3V	DC supply voltage for module	Wait >1ms for module to stabilize after power application
3	USB_D+	-	-	Unused	-
4	3.3V	PWR	3.3V	DC supply voltage for module	Wait >1ms for module to stabilize after power application
5	USB_D-	-	-	Unused	-
6	LED1#	-	-	Unused	-
7	GND	-	-	Ground	GND
8	PCM_CLK	-	-	Unused	-
9	SDIO CLK	I	1.8V	SDIO clock input	-
10	PCM_SYNC	-	-	Unused	-
11	SDIO CMD	I/O	1.8V	SDIO command line	-
12	PCM_OUT	-	-	Unused	-
13	SDIO DATA0	I/O	1.8V	SDIO data line 0	-
14	PCM_IN	-	-	Unused	-
15	SDIO DATA1	I/O	1.8V	SDIO data line 1	-
16	LED2#	-	-	Unused	-
17	SDIO DATA2	I/O	1.8V	SDIO data line 2	-
18	VIO_CFG	O	-	Sideband IO voltage indication. Connected to ground for 3.3V on the sideband IO signals. Otherwise, it must be left unconnected.	GND
19	SDIO DATA3	I/O	1.8V	SDIO data line 3	-
20	UART WAKE#	O	3.3V	BT_WAKE_OUT - Output signal to wake Host.	-
21	SDIO WAKE#	O	1.8V	WL_HOST_WAKE - Output signal to wake host.	-
22	UART_TXD	O	1.8V	Serial data output for the HCI UART interface.	-
23	SDIO RESET#	-	-	Unused	-
32	UART_RXD	I	1.8V	Serial data input for the HCI UART interface.	-
33	GND	-	-	Ground	GND
34	UART_RTS	O	1.8V	Active-Low request-to-send signal for the HCI UART interface.	-
35	PERp0	-	-	Unused	-
36	UART_CTS	I	1.8V	Active-Low clear-to-send signal for the HCI UART interface.	-
37	PERn0	-	-	Unused	-


Pin#	M.2 Signal Name	Type	Voltage Ref	TI351 Function	Comment
38	VENDOR DEFINED38	-	-	Unused	-
39	GND	-	-	Ground	GND
40	VENDOR DEFINED40	-	-	Unused	-
41	PETp0	-	-	Unused	-
42	VENDOR DEFINED42	-	-	Unused	-
43	PETn0	-	-	Unused	-
44	COEX3	I	1.8V	COEX_PRIORITY	Unused
45	GND	-	-	Ground	GND
46	COEX_TXD	O	1.8V	COEX_GRANT	Unused
47	REFCLKp0	-	-	Unused	-
48	COEX_RXD	I	1.8V	COEX_REQ	Unused
49	REFCLKn0	-	-	Unused	-
50	SUSCLK	I	3.3V	External Sleep Clock input (32.768KHz)	TI351 M.2 2230 card contains TCXO
51	GND	-	-	Ground	GND
52	PERST0#	-	-	Unused	-
53	CLKREQ0#	-	-	Unused	-
54	W_DISABLE2#	-	-	Unused	-
55	PEWAKE0#	-	-	Unused	-
56	W_DISABLE1#	I	3.3V	Reset line for enabling/disabling device (active low)	Hold low for >10us after power input stabilized
57	GND	-	-	Ground	GND
58	I2C DATA	-	-	Unused	-
59	RESERVED	-	-	Unused	-
60	I2C CLK	-	-	Unused	-
61	RESERVED	-	-	Unused	-
62	ALERT#	-	-	Unused	-
63	GND	-	-	Ground	GND
64	RESERVED	-	-	Unused	-
65	RESERVED	-	-	Unused	-
66	UIM_SWP	-	-	Unused	-
67	RESERVED	-	-	Unused	-
68	UIM_POWER_SNK	-	-	Unused	-
69	GND	-	-	Ground	GND
70	UIM_POWER_SRC	-	-	Unused	-
71	RESERVED	-	-	Unused	-

Pin#	M.2 Signal Name	Type	Voltage Ref	TI351 Function	Comment
72	3.3V	PWR	3.3V	DC supply voltage for module	Wait >1ms for module to stabilize after power application
73	RESERVED	-	-	Unused	-
74	3.3V	PWR	3.3V	DC supply voltage for module	Wait >1ms for module to stabilize after power application
75	GND	-	-	Ground	GND

## 6 Specifications

Table 6: SONA TI351 Specifications

Feature	Description				
<b>Physical Interfaces</b>	2230 E-Key standard form factor meeting PCIe M.2 Type 2230 Key Mechanical Outline M.2 1216 96-pin LGA package meeting PCIe M.2 Type 1216-S3 Mechanical Outline (453-00199 MHF4 module) M.2 1216 76-pin LGA package with non-standard footprint (453-00200 chip antenna module)				
<b>Wi-Fi Interface</b>	Secure Digital I/O (SDIO) v2.0				
<b>Bluetooth/BLE Interface</b>	Host Controller Interface (HCI) using high speed UART				
<b>Main Chipset</b>	Texas Instruments CC3351ENJARSBR				
<b>Input Power Supply Voltage Requirements</b>	1216 LGA module package <ul style="list-style-type: none"> <li>3.3V nominal <math>V_{PA}</math> 3.0V min, 3.6V max</li> <li>1.8V nominal <math>V_{IO}</math> 1.62V min, 1.98V max</li> </ul> 2230 Key-E module package <ul style="list-style-type: none"> <li>3.3V nominal <math>V_{IN}</math> 3.0V min, 3.6V max</li> </ul>				
<b>I/O Signalling Voltage</b>	Compliant with M.2 standard Typical DC 1.8 V $\pm$ 5%				
<b>Operating Temperature</b>	-40° to +85°C (-40° to +185°F)				
<b>Operating Humidity</b>	Less than 85% RH (non-condensing)				
<b>Storage Temperature</b>	-55° to +125°C (-67° to +257°F)				
<b>Storage Humidity</b>	Less than 60% RH (non-condensing)				
<b>MSL (Moisture Sensitivity Level)</b>	MSL4 (1216 module), MSL1 (2230 module)				
<b>Maximum Electrostatic Discharge</b>	Conductive 4KV; Air coupled 8KV (follows EN61000-4-2)				
<b>Size</b>	<table border="0"> <tr> <td>M.2 1216</td> <td>M.2 E-Key</td> </tr> <tr> <td> <ul style="list-style-type: none"> <li>Length: 16 mm</li> <li>Width: 12 mm</li> <li>Thickness: 1.75 mm</li> </ul> </td> <td> <ul style="list-style-type: none"> <li>Length: 30 mm</li> <li>Width: 22 mm</li> <li>Thickness: 2.7 mm</li> </ul> </td> </tr> </table>	M.2 1216	M.2 E-Key	<ul style="list-style-type: none"> <li>Length: 16 mm</li> <li>Width: 12 mm</li> <li>Thickness: 1.75 mm</li> </ul>	<ul style="list-style-type: none"> <li>Length: 30 mm</li> <li>Width: 22 mm</li> <li>Thickness: 2.7 mm</li> </ul>
M.2 1216	M.2 E-Key				
<ul style="list-style-type: none"> <li>Length: 16 mm</li> <li>Width: 12 mm</li> <li>Thickness: 1.75 mm</li> </ul>	<ul style="list-style-type: none"> <li>Length: 30 mm</li> <li>Width: 22 mm</li> <li>Thickness: 2.7 mm</li> </ul>				
<b>Weight - g (oz.)</b>	<table border="0"> <tr> <td>M.2 1216</td> <td>M.2 E-Key</td> </tr> <tr> <td> <ul style="list-style-type: none"> <li>TBD</li> </ul> </td> <td> <ul style="list-style-type: none"> <li>TBD</li> </ul> </td> </tr> </table>	M.2 1216	M.2 E-Key	<ul style="list-style-type: none"> <li>TBD</li> </ul>	<ul style="list-style-type: none"> <li>TBD</li> </ul>
M.2 1216	M.2 E-Key				
<ul style="list-style-type: none"> <li>TBD</li> </ul>	<ul style="list-style-type: none"> <li>TBD</li> </ul>				
<b>Wi-Fi Standards</b>	IEEE 802.11ax, 11a/b/g/n, 11d/h, 11r, 11w, 11e, 11k, 11ai, 11v				
<b>Bluetooth Standards</b>	Bluetooth 5.4 (Low Energy)				
<b>Wi-Fi Data Rates Supported</b>	Support 802.11 ax/a/b/g/n 802.11b (DSSS, CCK) 1, 2, 5.5, 11 Mbps 802.11a/g (OFDM) 6, 9, 12, 18, 24, 36, 48, 54 Mbps 802.11n (OFDM, HT20, MCS0-7) 802.11ax (2.4 GHz / OFDM / HE20 / MCS0-7; 2.4 GHz / OFDMA / HE20 / MCS0-7) 802.11ax (5 GHz / OFDM / HE20 / MCS0-7; 5 GHz / OFDMA / HE20 / MCS0-7)				
<b>802.11ax/n Spatial Streams</b>	Single (20 MHz)				
<b>Bluetooth LE Data Rates Supported</b>	1, 2 Mbps, 500 Kbps (S=2), 125 Kbps (S=8)				
<b>Bluetooth LE Modulation</b>	GFSK @ 1, 2 Mbps GFSK @ 125, 500 Kbps				

Feature	Description																												
Regulatory Certifications	United States (FCC) EU - Member countries of European Union (ETSI) Great Britain (UKCA) Canada (ISED) Australia/New Zealand (RCM) Japan (MIC) - pending Korea (KCC) - pending																												
2.4 GHz Frequency Bands (Wi-Fi)	<b>EU:</b> 2.4 GHz to 2.483 GHz <b>FCC/ISED:</b> 2.4 GHz to 2.473 GHz <b>UKCA:</b> 2.4 GHz to 2.483 GHz <b>MIC:</b> 2.4 GHz to 2.483 GHz (Channel 14 not supported) <b>RCM:</b> 2.4 GHz to 2.483 GHz <b>KCC:</b> 2.4 GHz to 2.483 GHz																												
2.4 GHz Operating Channels (Wi-Fi)	<b>EU:</b> 13 (3 non-overlapping) <b>FCC/ISED:</b> 11 (3 non-overlapping) <b>UKCA:</b> 13 (3 non-overlapping) <b>MIC:</b> 13 (3 non-overlapping) (Channel 14 not supported) <b>RCM:</b> 13 (3 non-overlapping) <b>KCC:</b> 13 (3 non-overlapping)																												
5 GHz Operating Channels (Wi-Fi)	<b>EU:</b> 24 non-overlapping; <b>FCC:</b> 25 non-overlapping <b>ISED:</b> 22 non-overlapping; <b>MIC:</b> 19 non-overlapping <b>RCM:</b> 21 non-overlapping, <b>KCC:</b> 24 non-overlapping																												
Operating Systems Supported	Linux Android																												
Compliance	<table border="1"> <thead> <tr> <th colspan="2">EU</th> </tr> </thead> <tbody> <tr> <td>EN 300 328</td> <td>EN 62368-1:2014</td> </tr> <tr> <td>EN 301 489-1</td> <td>EN 300 440</td> </tr> <tr> <td>EN 301 489-17</td> <td>EN 303 687</td> </tr> <tr> <td>EN 301 893</td> <td>2011/65/EU (RoHS)</td> </tr> <tr> <th>FCC</th> <th>ISED Canada</th> </tr> <tr> <td>47 CFR FCC Part 15.247</td> <td>RSS-247</td> </tr> <tr> <td>47 CFR FCC Part 15.407</td> <td>RSS-248</td> </tr> <tr> <td>47 CFR FCC Part 2.1091</td> <td></td> </tr> <tr> <th>AS/NZS</th> <th>MIC</th> </tr> <tr> <td>AS/NZS 4268:2017</td> <td>ARIB STD-T66/RCR STD-33 (2.4 GHz)</td> </tr> <tr> <td></td> <td>ARIB STD-T71 (5 GHz)</td> </tr> <tr> <td></td> <td>Article 2 Paragraph 1 of Item 80 :</td> </tr> <tr> <td></td> <td>LPI (ZR), 6 GHz</td> </tr> </tbody> </table>	EU		EN 300 328	EN 62368-1:2014	EN 301 489-1	EN 300 440	EN 301 489-17	EN 303 687	EN 301 893	2011/65/EU (RoHS)	FCC	ISED Canada	47 CFR FCC Part 15.247	RSS-247	47 CFR FCC Part 15.407	RSS-248	47 CFR FCC Part 2.1091		AS/NZS	MIC	AS/NZS 4268:2017	ARIB STD-T66/RCR STD-33 (2.4 GHz)		ARIB STD-T71 (5 GHz)		Article 2 Paragraph 1 of Item 80 :		LPI (ZR), 6 GHz
EU																													
EN 300 328	EN 62368-1:2014																												
EN 301 489-1	EN 300 440																												
EN 301 489-17	EN 303 687																												
EN 301 893	2011/65/EU (RoHS)																												
FCC	ISED Canada																												
47 CFR FCC Part 15.247	RSS-247																												
47 CFR FCC Part 15.407	RSS-248																												
47 CFR FCC Part 2.1091																													
AS/NZS	MIC																												
AS/NZS 4268:2017	ARIB STD-T66/RCR STD-33 (2.4 GHz)																												
	ARIB STD-T71 (5 GHz)																												
	Article 2 Paragraph 1 of Item 80 :																												
	LPI (ZR), 6 GHz																												
Certifications	Bluetooth® SIG Qualification 																												
Warranty	One Year Warranty																												

## 7 WLAN Functional Description

### 7.1 Overview

The Sona TI351 series wireless module is designed using the Texas Instruments CC3351ENJARSBR Wi-Fi 6 chipset. It is optimized for high speed, reliability, and low-power embedded applications. It is integrated with dual-band WLAN (2.4/5 GHz) and Bluetooth 5.4 (Low Energy).

Table 7: WLAN functions

Feature	Description
<b>WLAN Features</b>	<ul style="list-style-type: none"> <li>▪ Enhanced MAC for supporting IEEE 802.11 a/b/g/n/ax features.</li> <li>▪ Supports Wi-Fi 6 (IEEE 802.11ax) in STA mode</li> <li>▪ Supports IEEE 802.11 a/b/g/n in STA and AP roles</li> <li>▪ Access Point (AP) supporting up to 16 connected stations.</li> <li>▪ Multi-Role Multi-channel (STA-STA) (STA-AP)</li> <li>▪ Transmission and reception of A-MPDU frames</li> <li>▪ Reception of A-MSDU frames</li> <li>▪ Support for 4 Block Acknowledgement (BA) sessions per TX link, 8 BA sessions per RX link</li> <li>▪ EDCA support in both AP and STA mode. Configurable in AP role.</li> <li>▪ Transmission and reception of HE-SU and HE-ER-SU PPDU.</li> <li>▪ Reception of HE-MU PPDU -OFDMA/MU-MIMO Frame.</li> <li>▪ Transmission of HE-TB PPDU (Uplink MU OFDMA).</li> <li>▪ Channel Switch announcement in STA mode</li> <li>▪ Multicast Filtering (STA role)</li> <li>▪ QoS support for four Traffic ID (TID) in transmission, eight TIDs in reception.</li> <li>▪ Support for power management schemes, including WMM power-save.</li> <li>▪ Target Wake Time (TWT)</li> <li>▪ Support for coexistence with Bluetooth</li> </ul>
<b>WLAN Security</b>	<ul style="list-style-type: none"> <li>▪ 802.11 standard-compliant security support:                             <ul style="list-style-type: none"> <li>- Personal: WPA/WPA2-PSK, WPA2, WPA3 (STA and AP)</li> <li>- WPA2/WPA3 Enterprise: WPA3 GCMP + 192-bit keys (STA only)</li> <li>- Encryptions: EAP-TLS, EAP-TTLS, PEAPv0-MSCHAP, TTLS-MSCHAP</li> </ul> </li> <li>▪ On-chip cryptographic engine. HW accelerator to offload data encryption/decryption.</li> <li>▪ HW-based mechanism for authentication origin of content using asymmetric keys</li> <li>▪ Secure boot to validate authenticity of runtime binary as signed.</li> </ul>

#### WLAN Channel

Channel frequencies supported.

2.4 GHz / 20 MHz		5 GHz / 20 MHz	
Channel	Frequency (MHz)	Channel	Frequency (MHz)
1	2412	36	5180
2	2417	40	5200
3	2422	44	5220
4	2427	48	5240
5	2432	52	5260
6	2437	56	5280
7	2442	60	5300
8	2447	64	5320
9	2452	100	5500
10	2457	104	5520
11	2462	108	5540
12	2467	112	5560
13	2472	116	5580
		120	5600
		124	5620
		128	5640
		132	5660

Feature	Description
	136 5680
	140 5700
	144 5720
	149 5745
	153 5765
	157 5785
	161 5805
	165 5825

## 8 Bluetooth Functional Description

The Sona TI351 series wireless module includes a fully integrated Bluetooth baseband/radio. Several features and functions are listed in [Table 8](#).

**Table 8: Bluetooth functions**

Feature	Description
<b>Bluetooth Interface</b>	<ul style="list-style-type: none"> <li>High-Speed UART interface</li> </ul>
<b>Bluetooth Core functionality</b>	<ul style="list-style-type: none"> <li>Supports Bluetooth LE PHYs                             <ul style="list-style-type: none"> <li>1M</li> <li>2M</li> <li>Coded (S=2, S=8)</li> </ul> </li> <li>Legacy and Extended Advertisements</li> <li>Legacy and Extended Scan</li> <li>GATT Read/Write</li> <li>Secured Connection</li> </ul>
<b>Bluetooth Features</b>	<ul style="list-style-type: none"> <li>Supports features of Bluetooth Core Specification version 5.4 (Low Energy)</li> <li>Supported BLE Roles:                             <ul style="list-style-type: none"> <li>Broadcaster</li> <li>Peripheral</li> <li>Observer</li> <li>Central</li> </ul> </li> <li>BLE Multirole enables simultaneous operation of 2 BLE roles.</li> <li>Up to 16 BLE connections.</li> <li>Standard Bluetooth test modes</li> <li>Transmit Power Control</li> </ul>

## 9 Electrical Characteristics

### 9.1 Absolute Maximum Ratings

Absolute maximum ratings are those values beyond which damage to the device can occur. Functional operation under these conditions, or at any other condition beyond those indicated in the operational sections of this document, is not recommended.

**Note:** Maximum rating for signals follows the supply domain of the signals.

**Table 9: Absolute maximum ratings**

Symbol (Domain)	Description	Max Rating	Unit
3.3V V <sub>PA</sub>	VDD PA power supply (M.2 1216)	4.2	V
VIO_1.8V	DC supply voltage for digital I/O (M.2 1216)	2.1	V
3.3V	External 3.3V power supply (M.2 2230 E-Key)	3.6	V
Storage	Storage temperature	-55 to +125	°C
ESD	Electrostatic discharge tolerance	2000	V

### 9.2 Recommended Operating Conditions

**Table 10: Recommended operating conditions**

Symbol (Domain)	Parameter	Min	Typ	Max	Unit
3.3V V <sub>PA</sub>	VDD PA power supply (M.2 1216)	3.0	3.3	3.6	V
VIO_1.8V	DC supply voltage for digital I/O (M.2 1216)	1.62	1.8	1.98	V
3.3V	External 3.3V power supply (M.2 2230 E-Key)	3.0	3.3	3.6	V
T-ambient	Ambient temperature	-40	25	+85	°C

### 9.3 DC Electrical Characteristics

Table 11 lists the general DC electrical characteristics over recommended operating conditions (unless otherwise specified).

**Table 11: General DC electrical characteristics (For 1.8V operation VDDIO)**

Symbol	Parameter	Conditions	Min	Typ	Max	Unit
VIH	High Level Input Voltage	–	0.65 x VDDIO	–	VDDIO	V
VIL	Low Level Input Voltage	–	0	–	0.35 x VDDIO	V
VOH	Output high Voltage	4mA	VDDIO – 0.45	–	VIO	V
VOL	Output low Voltage	4mA	0	–	0.45	V

## 9.4 Low Power States Current Consumption

Table 12 lists the nominal device current consumption at room temperature.

Table 12: Low power current consumption

Mode	Conditions	Model variant	Supply	Typ	Unit
Shutdown	External supplies available Device in reset (nRESET low)	M.2 1216	VIO_1.8V	10	μA
			3.3V V <sub>PA</sub>	2	μA
	M.2 2230	3.3V	TBD	μA	
Sleep	Low Power Mode RAM retention	M.2 1216	VIO_1.8V	330	μA
			3.3V V <sub>PA</sub>	2	μA
	M.2 2230	3.3V	TBD	μA	

## 9.5 WLAN Radio Receiver Characteristics

Table 13 and Table 14 summarize the Sona TI351 series wireless module receiver characteristics.

Table 13: Typical WLAN receiver characteristics for 2.4 GHz single chain operation, room temperature

Item	Parameter	Conditions	Min	Typ	Max	Unit
Frequency Range	Receive input frequency range	–	2.412	–	2.472	GHz
RX Sensitivity	DSSS, 1 Mbps	8% PER	–	-97	–	dBm
	CCK, 11 Mbps	8% PER	–	-88	–	
	OFDM, 6 Mbps	10% PER	–	-92	–	
	OFDM, 54 Mbps	10% PER	–	-74	–	
	HT20, MCS0	10% PER	–	-92	–	
	HT20, MCS7	10% PER	–	-72	–	
	HE20, MCS0	10% PER	–	-91	–	
	HE20, MCS7	10% PER	–	-72	–	
Maximum Input Level	DSSS, 1 Mbps	8% PER	–	0	–	dBm
	OFDM, 6 Mbps; HT MCS0, HE MCS0	10% PER	–	0	–	
	OFDM, 54 Mbps; HT MCS7, HE MCS7	10% PER	–	-9	–	
ACI – Adjacent Channel Rejection	DSSS, 1 Mbps	–	–	20	–	dB
	CCK, 11 Mbps	–	–	39	–	
	OFDM, 6 Mbps	–	–	20	–	
	OFDM, 54 Mbps	–	–	3	–	
	HT20, MCS0	–	–	20	–	
	HT20, MCS7	–	–	3	–	
	HE20, MCS0	–	–	16	–	
	HE20, MCS7	–	–	-1	–	

Table 14: Typical WLAN receiver characteristics for 5 GHz single chain operation, room temperature

Item	Parameter	Conditions	Min	Typ	Max	Unit
Frequency Range	Receive input frequency range	—	5.15	—	5.85	GHz
RX Sensitivity	OFDM, 6 Mbps	10% PER	—	-92	—	dBm
	OFDM, 54 Mbps		—	-74	—	
	HT20, MCS0		—	-91	—	
	HT20, MCS7		—	-72	—	
	HE20, MCS0		—	-89	—	
	HE20, MCS7		—	-70	—	

## 9.6 WLAN Transmitter Characteristics

Table 15 through Table 20 summarize the Sona TI351 series wireless module WLAN transmitter characteristics at room temperature.

Table 15: WLAN transmitter characteristics for 2.4 GHz operation (VPA = 3.3V, VDDIO = 1.8V)

Parameter	Conditions	Min	Typ	Max	Unit
Transmit output frequency range	—	2.402	—	2.472	GHz
Output power <sup>[1]</sup>	DSSS, 1 Mbps	—	—	17	dBm
	CCK, 11 Mbps	—	—	17	
	OFDM, 6 Mbps	—	—	16.7	
	OFDM, 54 Mbps	—	—	15.3	
	HT20, MCS0	—	—	16.7	
	HT20, MCS7	—	—	15.3	
	HE20, MCS0	—	—	16.5	
	HE20, MCS7	—	—	14.5	

Note 1: Final TX power values on each channel are limited by regulatory requirements.

Table 16: M.2 1216 module WLAN transmitter current consumption at 2.4 GHz (VPA = 3.3V, VDDIO = 1.8V) – at maximum TX power setting

Modulation	VPA 3.3V Current Consumption (mA)	VIO 1.8V Current Consumption (mA)
DSSS, 1 Mbps	245	90
CCK, 11 Mbps	240	90
OFDM, 6 Mbps	230	95
OFDM, 54 Mbps	195	95
HT20, MCS0	225	95
HT20, MCS7	200	95
HE20, MCS0	225	95
HE20, MCS7	200	95

Table 17: M.2 2230 module WLAN transmitter current consumption at 2.4 GHz (VDD = 3.3V) – at maximum TX power setting

Modulation	3.3V Current Consumption (mA)
DSSS, 1 Mbps	355
CCK, 11 Mbps	360
OFDM, 6 Mbps	350
OFDM, 54 Mbps	320
HT20, MCS0	350
HT20, MCS7	320
HE20, MCS0	350
HE20, MCS7	320

Table 18: WLAN transmitter characteristics for 5 GHz operation (VBAT=3.3V, VDDIO=1.8V)

Parameter	Conditions	Min	Typ	Max	Unit
Transmit output frequency range	–	5.15	–	5.85	GHz
Output power <sup>[2]</sup>	OFDM, 6 Mbps	–	–	15.5	dBm
	OFDM, 54 Mbps	–	–	13.0	
	HT20, MCS0	–	–	15.0	
	HT20, MCS7	–	–	13.0	
	HE20, MCS0	–	–	15.0	
	HE20, MCS7	–	–	13.0	

**Note 2:** Final TX power values on each channel are limited by regulatory requirements.

Table 19: M.2 1216 module WLAN transmitter current consumption at 5 GHz (VPA = 3.3V, VDDIO = 1.8V) – at maximum TX power setting

Modulation	VPA 3.3V Current Consumption (mA)	VIO 1.8V Current Consumption (mA)
OFDM, 6 Mbps	240	150
OFDM, 54 Mbps	180	150
HT20, MCS0	240	150
HT20, MCS7	180	150
HE20, MCS0	235	150
HE20, MCS7	180	150

Table 20: M.2 2230 module WLAN transmitter current consumption at 5 GHz (VDD = 3.3V) – at maximum TX power setting

Modulation	3.3V Current Consumption (mA)
OFDM, 6 Mbps	400
OFDM, 54 Mbps	335
HT20, MCS0	400
HT20, MCS7	340
HE20, MCS0	400
HE20, MCS7	340

## 9.7 Bluetooth Radio Characteristics

Table 21 through Table 23 describe the performance of the Bluetooth Low Energy transmitter and receiver and the current consumption at 25°C.

Table 21: BLE RF Specifications (VPA = 3.3V, VDDIO = 1.8V)

Parameter	Conditions	Min	Typ	Max	Unit	
Frequency range	–	2402	–	2480	MHz	
Rx saturation	GFSK, PER ≤ 30.8%	–	0	–	dBm	
Rx sensitivity <sup>[1]</sup>	GFSK, PER ≤ 30.8%	1 Mbps	–	-97 <sup>[2]</sup>	–	dBm
		2 Mbps	–	-94 <sup>[2]</sup>	–	dBm
		500 Kbps	–	-99	–	dBm
		125 Kbps	–	-102	–	dBm
C/I Co-channel rejection <sup>[3]</sup>	Modulated interferer	1 Mbps	–	10	–	dB
		2 Mbps	–	10	–	dB
		500 Kbps	–	10	–	dB
		125 Kbps	–	10	–	dB

Parameter	Conditions		Min	Typ	Max	Unit
C/I 1 MHz Selectivity <sup>[3]</sup>	Modulated interferer at ±1MHz	1 Mbps	–	0/0	–	dB
		500 Kbps	–	0/0	–	dB
		125 Kbps	–	0/0	–	dB
C/I 2 MHz Selectivity <sup>[3]</sup>	Modulated interferer at ±2MHz	1 Mbps	–	-35/-28	–	dB
		2 Mbps	–	0/0	–	dB
		500 Kbps	–	-35/-25	–	dB
		125 Kbps	–	-37/-30	–	dB
C/I 3 MHz Selectivity <sup>[3]</sup>	Modulated interferer at ±3MHz	1 Mbps	–	-38/-32	–	dB
		500 Kbps	–	-40/-37	–	dB
		125 Kbps	–	-39/-36	–	dB
C/I 4 MHz Selectivity <sup>[3]</sup>	Modulated interferer at ±4MHz	1 Mbps	–	-45/-40	–	dB
		2 Mbps	–	-35/-28	–	dB
		500 Kbps	–	-45/-40	–	dB
		125 Kbps	–	-45/-41	–	dB
Out-of-Band Blocking Performance	1 Mbps Wanted signal @ -67 dBm	30-2000 MHz	–	-23	–	dBm
		2-2.399 GHz	–	-30	–	dBm
		2.484-3 GHz	–	-30	–	dBm
		3-6 GHz	–	-21	–	dBm
Intermodulation	Wanted signal at 2402MHz, -64 dBm Interferers at 2405 and 2408 MHz	1 Mbps	–	-40	–	dBm
		2 Mbps	–	-44	–	dBm
Tx power <sup>[4]</sup>	–	–	–	–	7	dBm

**Notes:**

[1] Dirty Tx is Off.

[2] BLE 1M PHY sensitivity on channels 17 and 39 may degrade by up to 2.5dB, BLE 2M PHY sensitivity on channel 17 may degrade by up to 1.5 dB

[3] Wanted signal levels differ with PHY: 1 Mbps @ -67dBm, 2 Mbps @ -67 dBm, 500 kbps @ -72 dBm, 125 kbps @-79 dBm.

[4] The Bluetooth LE TX power cannot exceed 10 dBm EIRP specification limit. The antenna gain/loss must be factored in so as not to exceed the limit.

**Table 22: M.2 1216 modules BLE radio current consumption (VPA = 3.3V, VDDIO = 1.8V)**

Operation Mode	VPA Current Consumption (mA)	VDD_IO Current Consumption (mA)
BLE TX <sup>[1]</sup>	110	90
BLE RX	0	60

Note 1: BLE TX power setting = 10 dBm

**Table 23: M.2 2230 module BLE radio current consumption (VDD = 3.3V)**

Operation Mode	VDD Current Consumption (mA)
BLE TX <sup>[1]</sup>	200
BLE RX	60

Note 1: BLE TX power setting = 10 dBm

## 10 Slow Clock Oscillator Requirements

The Sona TI351 modules use a slow clock running at 32.768 kHz for low power modes. On the M.2 1216 modules the slow clock can be generated internally or supplied externally. The internal oscillator is less accurate and consumes more power than sourcing the slow clock externally. When using the internal slow clock oscillator, leave the SUSCLK/SLOW\_CLK\_IN pin (Pin 27) unconnected.

An external clock source must meet the requirements listed in Table 24. This clock should be fed to the SUSCLK/SLOW\_CLK\_IN pin (Pin 27). The clock operation needs to be stable before the W\_DISABLE1#/nRESET line is de-asserted to enable the device.

**Table 24: External Slow Clock Requirements (453-00199 and 453-00200 modules)**

Parameter	Conditions	Min	Typ	Max	Unit
Clock Frequency	Square wave	–	32768	–	Hz
Frequency accuracy	Initial + temperature + aging	–	–	±250	ppm
Input Duty Cycle	OFDM, 54 Mbps	30	50	70	%
Rise and Fall times	10/90% and 90/10%	–	–	100	ns
Input Low Level		0	–	0.35 x VIO_1.8	V
Input High Level		0.65 x VIO_1.8	–	1.95	V
Input Impedance		1	–	–	MΩ
Input Capacitance		–	–	5	pF

**Note:** The M.2 2230 module (453-00209) includes an on module external slow clock oscillator.

# 11 Host Interface Specifications

## 11.1 SDIO Specifications

The Sona TI351 module SDIO host signals are the interface for WLAN and must be 1.8V at all times as defined by the M.2 standard.

### 11.1.1 Default mode

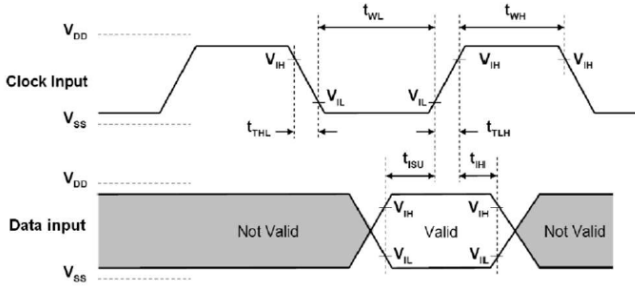


Figure 4: SDIO bus Input timing- Default mode (1.8V)

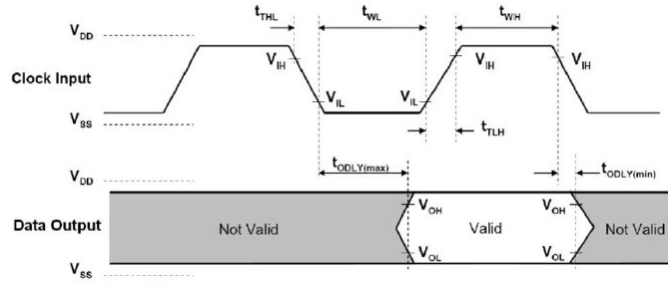


Figure 5: SDIO bus Output timing- Default mode (1.8V)

### 11.1.2 High Speed mode

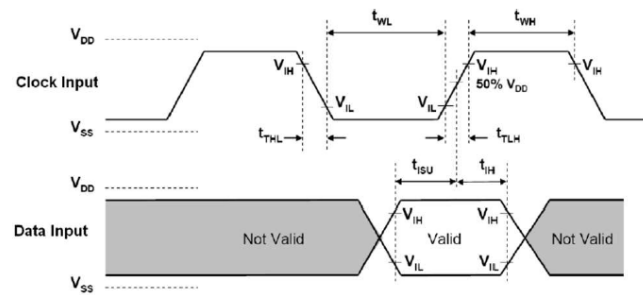


Figure 6: SDIO bus Input timing- High Speed mode (1.8V)

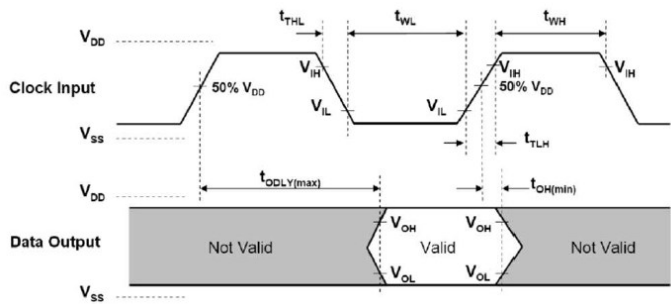


Figure 7: SDIO bus Output timing- High Speed mode

Table 25: SDIO timing requirements

Symbol	Parameter	Condition	Min.	Max.	Unit
$f_{clock}$	Clock Frequency	Default mode	-	26	MHz
		High-Speed mode	-	52	
$t_{HIGH}$	High Period	Default mode	10	-	ns
		High-Speed mode	7	-	
$t_{LOW}$	Low Period	Default mode	10	-	ns
		High-Speed mode	7	-	
$t_{TLH}$	Clock rise time	Default mode	-	10	ns
		High-Speed mode	-	3	
$t_{THL}$	Clock fall time	Default mode	-	10	ns
		High-Speed mode	-	3	
$t_{ISU}$	Setup time, input valid before CLK $\uparrow$	Default mode	5	-	ns
		High-Speed mode	6	-	
$t_{IH}$	Hold time, input valid after CLK $\uparrow$	Default Speed	5	-	ns
		High-Speed mode	2	-	
$t_{ODLY}$	Delay time, CLK $\downarrow$ to output valid	Default mode	2	14	ns
		High-Speed mode	2	14	
CL	Capacitive load (output lines)	Default mode	15	40	pF
		High-Speed mode	15	40	pF

## 11.2 UART Interface

The Sona TI351 series 4-wire UART is the main host interface for BLE access through the host controller interface (HCI) transport layer.

When using the UART interface with a host, take care to connect the lines correctly. The signal names as listed in the Pin Assignment Tables of [Section 5 Pin Definitions](#) are with respect to the TI351 module.

- UART\_TXD must be connected to host side UART\_RXD
- UART\_RXD must be connected to host side UART\_TXD
- UART\_CTS must be connected to host side UART\_RTS
- UART\_RTS must be connected to host side UART\_CTS

**Table 26: UART timing specifications**

Parameter	Condition	Min	Typ	Max	Unit
Baud rate		37.5	—	4364	kbps
Baud rate accuracy per byte	Receive/Transmit	-2.5	—	+1.5	%
Baud rate accuracy per bit	Receive/Transmit	-12.5	—	+12.5	%
CTS low to TX_DATA on	Hardware Flow Control	0	2	—	ms
CTS high to TX_DATA off		—	—	1	Byte
CTS high pulse wide		1	—	—	bit
RTS low to RX_DATA on		0	2	—	ms
RTS high to RX_DATA off	Interrupt set to ¼ FIFO	—	—	16	Byte

## 11.3 Coexistence Feature

Three coexistence lines are available to provide a means to organize wireless packet traffic for communication protocols operating in the same frequency band. When implemented, the Sona TI351 behaves as the COEX primary device to communicate to a COEX secondary device using a three-wire Packet Traffic Arbitration (PTA) interface. The coexistence signals on the TI351 are:

- COEX\_GRANT: An output signal, controlled by the TI351 indicating the response of the PTA decision.
- COEX\_PRIORITY: An input signal, controlled by the secondary device indicating the priority of a request signal.
- COEX\_REQ: An input signal, controlled by the secondary device indicating a request to use the shared frequency band.

## 12 Power-Up Sequence and Requirements

For proper operation of the Sona TI351, meet the following power-up sequence requirements.

### 12.1 M.2 1216 modules (453-00199 and 453-00200)

- Both module supply inputs (3.3V and VIO\_1.8V) must be available and stabilized before W\_DISABLE1#/nRESET line is released.
- If using an external slow clock, ensure that the clock operation is stable before W\_DISABLE1#/nRESET is released (set high).
- The W\_DISABLE1#/nRESET line is held low for at least 10µs after inputs are stabilized.
- The SDIO\_WAKE#/HOST\_IRQ\_WL line on the M.2 1216 module is sensed by the module on power up. The pin is pulled low internally and must remain low when the device powers up. **When this pin is connected to a host device, ensure that the line stays at a logic low level during module power-up and is not pulled high or driven high by the host platform.** Some host implementations may require a buffer device to be placed between the SDIO\_WAKE#/HOST\_IRQ\_WL module pin and the MCU GPIO pin used depending on how the MCU configures the GPIO on power up.

### 12.2 M.2 2230 module (453-00209)

- The module 3.3V supply input must be stable and allow at least 1ms for the module 1.8V power supply, slow clock, and level shifters to stabilize before W\_DISABLE1# line is released.
- The W\_DISABLE1# line is held low for at least 10µs after inputs are stabilized.

## 13 Mechanical Specifications

### 13.1 M.2 1216 MHF4 Connector (453-00199)

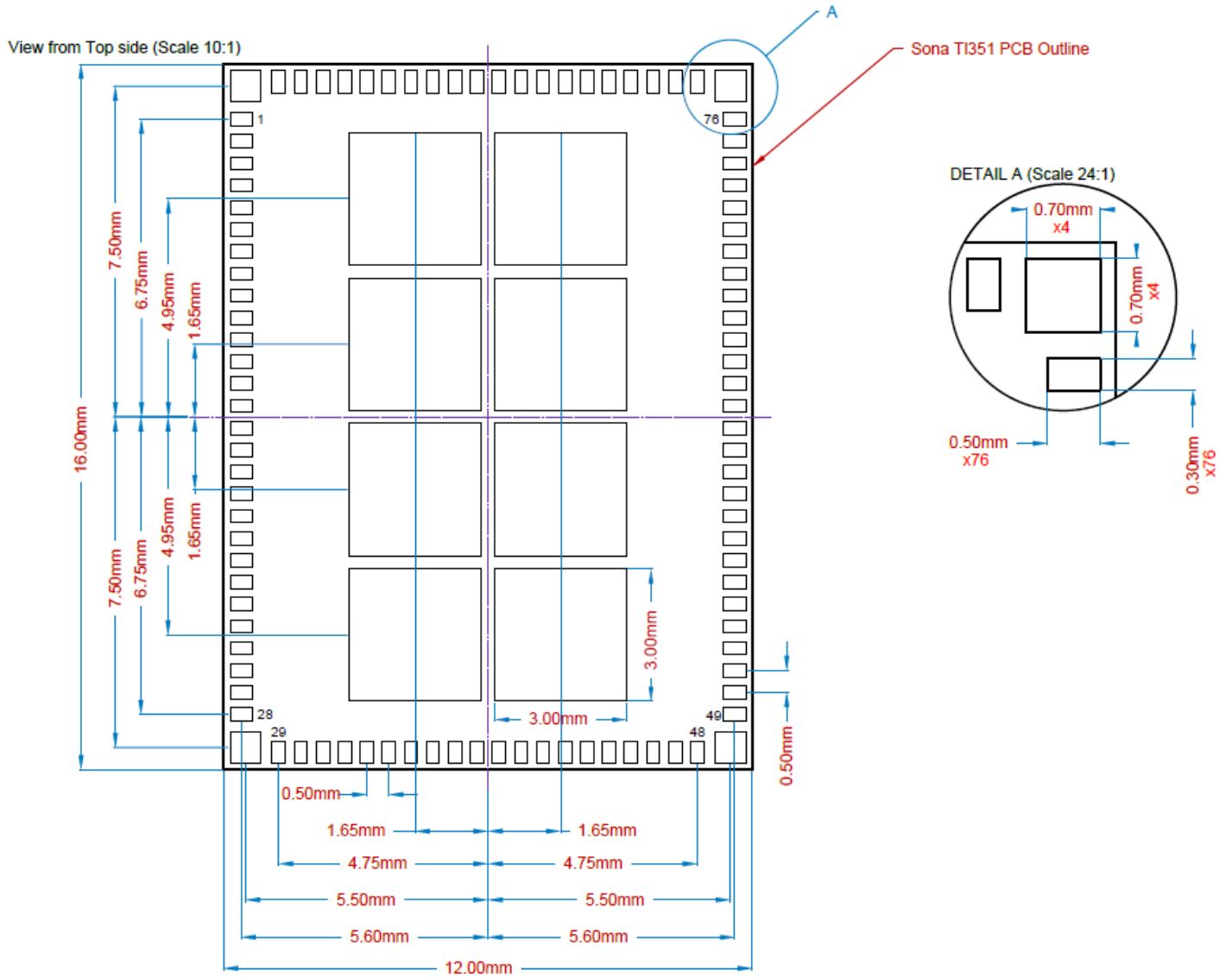


Figure 8: M.2 1216 PCB footprint (Top view) - TI351 MHF4 Module (453-00199)



**13.3 M.2 1216 Module Dimensions**

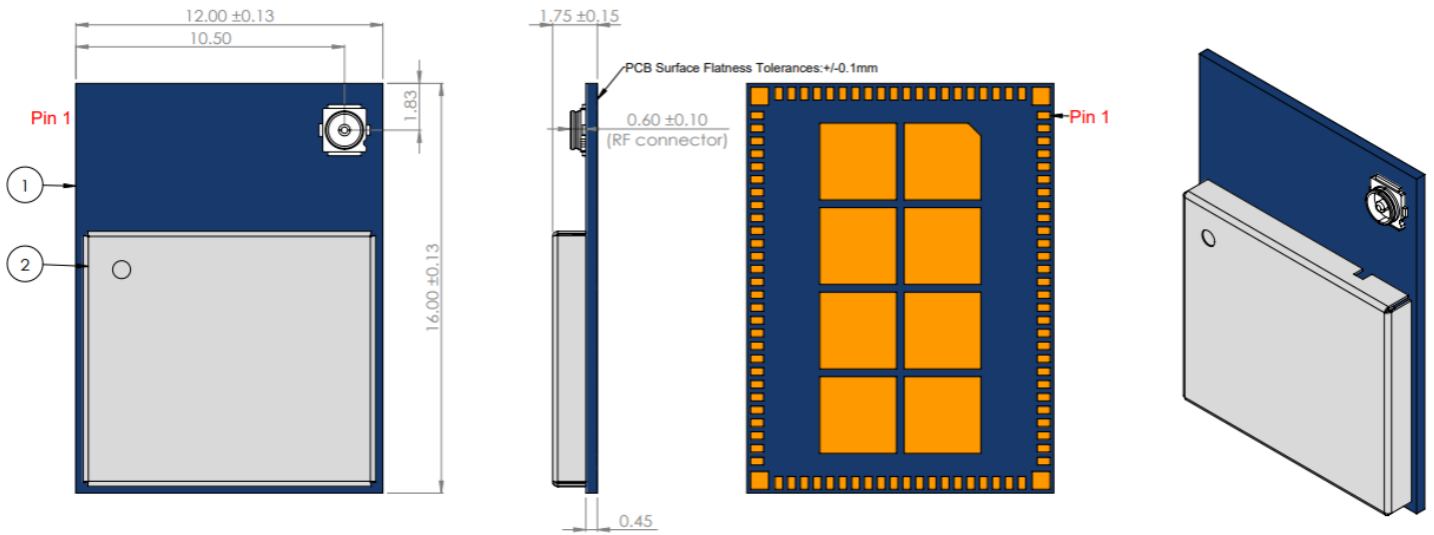


Figure 10: M.2 1216 (MHF4 variant)

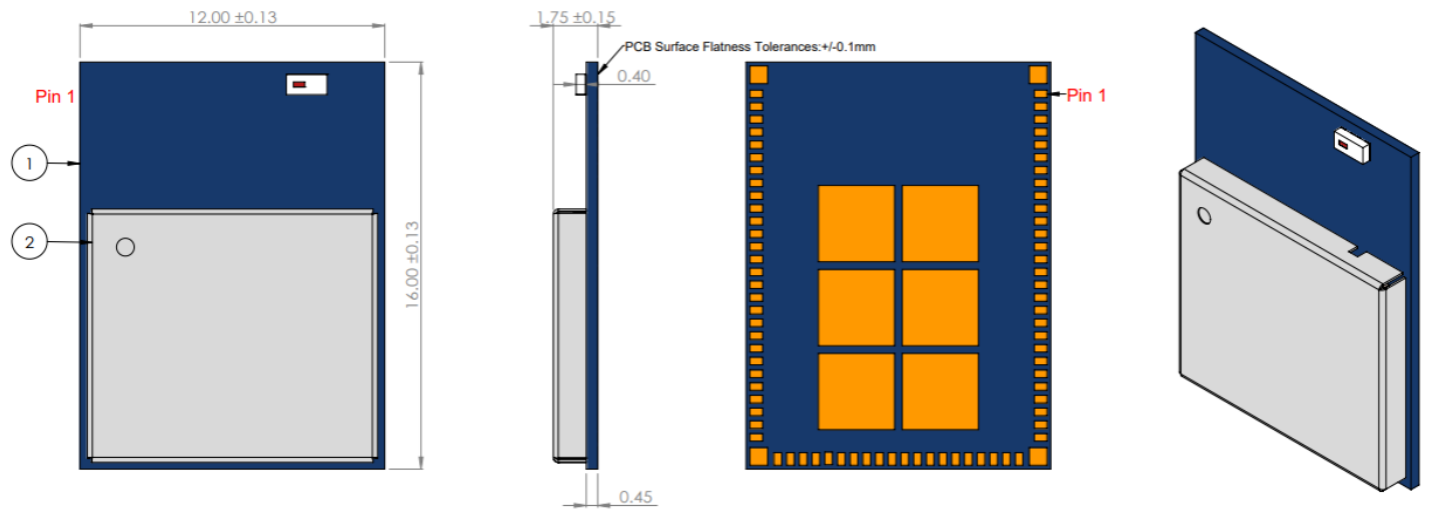


Figure 11: M.2 1216 (Chip Antenna variant)

### 13.4 M.2 2230 Key-E (453-00209)

Module dimensions of Sona TI351 M.2 2230 E-Key module is 22 x 30 x 2.55 mm. Detailed drawings are shown in Figure 12.

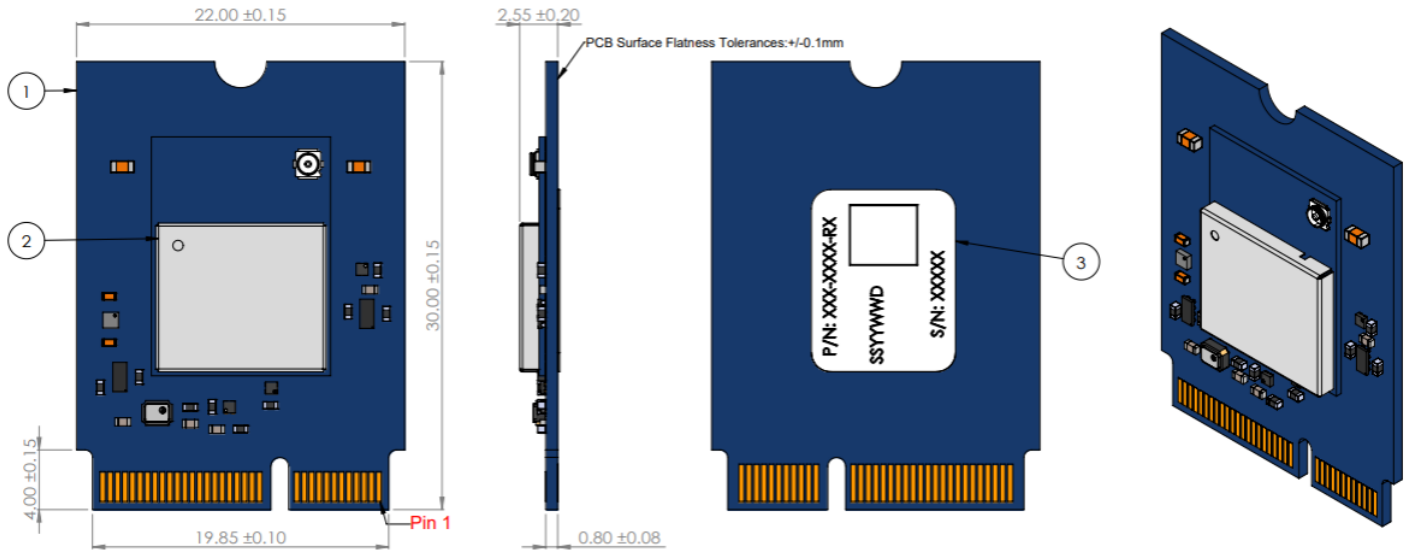


Figure 12: Sona TI351 M.2 2230 module

**Note:** The Wi-Fi MAC address is located on the product label.  
The last digit of Wi-Fi MAC address is assigned to either 0, 2, 4, 6, 8, A, C, E.  
The BT MAC address is the Wi-Fi MAC address plus 1.

### 13.5 M.2 2230 Key-E Mounting

The Sona TI351 M.2 2230 module connects to the host via a standard PCI EXPRESS M2 connector. The Kyocera ([www.kyocera-connector.com](http://www.kyocera-connector.com)) 6411 series provides 1.8 mm, 2.3 mm and 3.2 mm connector heights and the JAE (<https://www.jae.com/en/>) SM3 series provides 1.2 mm, 2.15 mm, 3.1 mm and 4.1 mm connector heights.

Because the Sona TI351 M.2 2230 module is a single-side component module, we recommend the following part numbers which have 2.3 mm and 3.1 mm connector height:

M.2 Key-E Connector	Connector Height
KYOCERA 24-6411-067-101-894E	2.3 mm
JAE SM3ZS067U310AERxxxx	3.1 mm

The stand-off mating to the recommend 2.3 mm connector from EMI STOP ([www.EMISTOP.com](http://www.EMISTOP.com)) is part number **F50M16-041525P1D4M** and 3.1mm from JAE (<https://www.jae.com/en/>) is part number **SM3ZS067U310-NUT1-Rxxxx**.

M.2 Key-E Connector	Stand-off
KYOCERA 24-6411-067-101-894E	EMI STOP F50M16-041525P1D4M
JAE SM3ZS067U310AERxxxx	JAE SM3ZS067U310-NUT1-Rxxxx

Detailed layout and stencil opening are shown as follows in Figure 13.

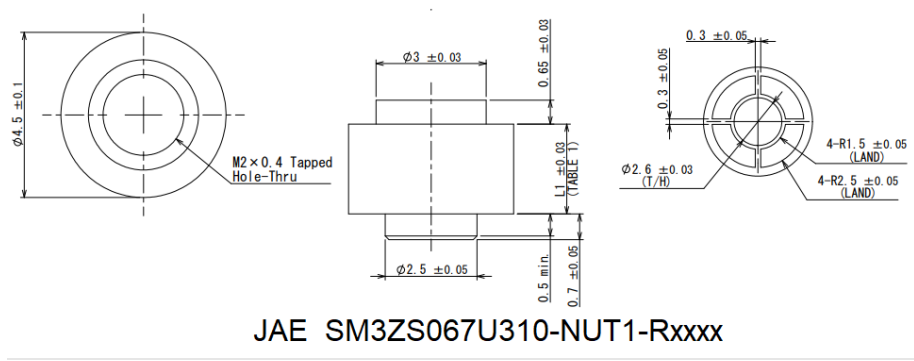
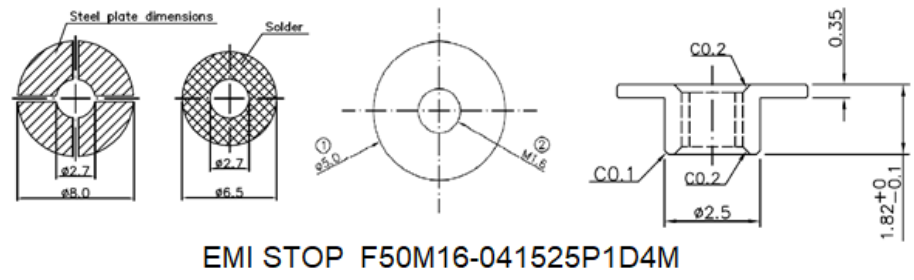
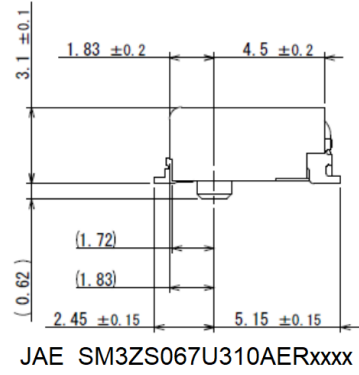
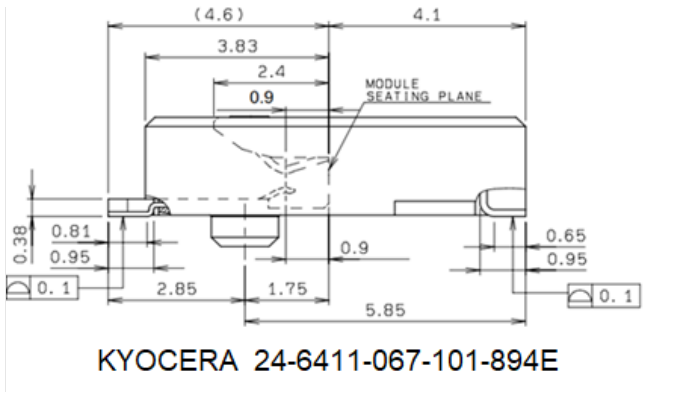


Figure 13: Mounting information for the Sona TI351 M.2 2230 module and recommended layout pattern for the stand-off

## 14 RF Layout Design Guidelines

The following is a list of RF layout design guidelines and recommendations when installing an Ezurio radio into your device.

- Do not run any antenna cables directly above or directly below the radio.
- Do not place any parts or run any high-speed digital lines below the radio.
- Ensure that there is the maximum allowable spacing separating the antenna connectors on the Ezurio radio from the antenna. In addition, do not place antennas directly above or directly below the radio.
- Ezurio recommends the use of a double-shielded cable for the connection between the radio and the antenna elements.
- Be sure to put a 10uF/16V/0603 capacitor on EACH 3.3V power pin. Also, place that capacitor as close as possible to the pin to make sure the internal PMU is working correctly.
- Use proper electro-static-discharge (ESD) procedures when installing the Ezurio radio module. To avoid negatively impacting Tx power and receiver sensitivity, do not cover the antennas with metallic objects or components.

### 14.1 Sona TI351 Integrated Antenna Guidelines

The Sona TI351 integrated antenna variant (453-00200) has specific placement and layout design guidelines that must be followed.

- The Sona TI351 Integrated antenna variant **MUST BE** located at the edge of the Host PCB and surrounded by ground on three sides.
- The antenna keep out region as defined in **Figure 14** must be kept clear of copper on all layers of the host PCB.
- Extending the ground on the Host PCB  $\geq 15\text{mm}$  from the module edge in each direction will optimize antenna performance.

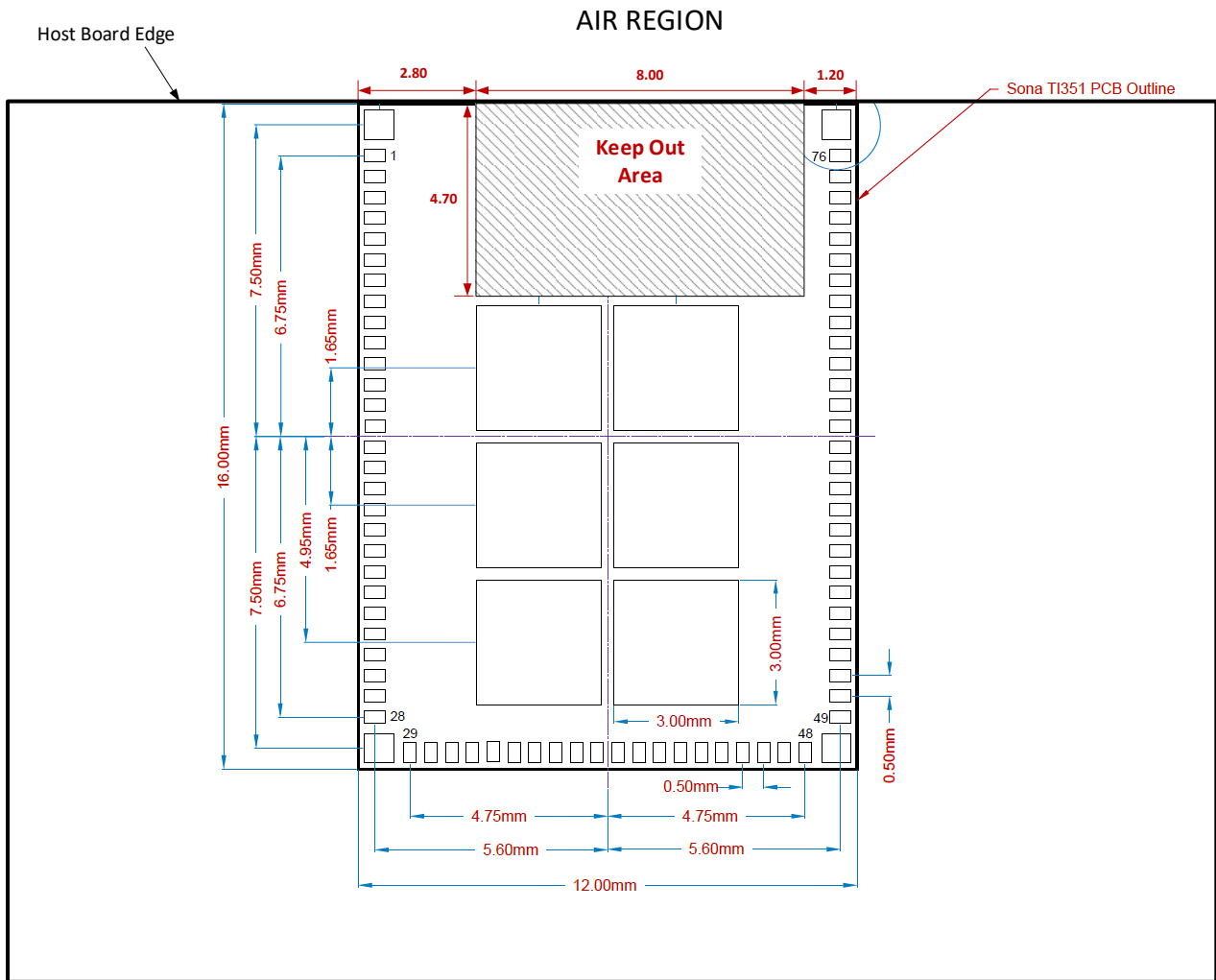


Figure 14: TI351 Integrated Chip Antenna Module Host Board Keep Out requirements.

## 15 Application Notes

### 15.1 Introduction

Ezurio's surface mount modules are designed to conform to all major manufacturing guidelines. This application note is intended to provide additional guidance beyond the information that is presented in the user manual. This application note is considered a living document and will be updated as new information is presented.

The modules are designed to meet the needs of several commercial and industrial applications. They are easy to manufacture and conform to current automated manufacturing processes.

### 15.2 Shipping and Labeling

#### 15.2.1 M.2 1216 Solder-Down

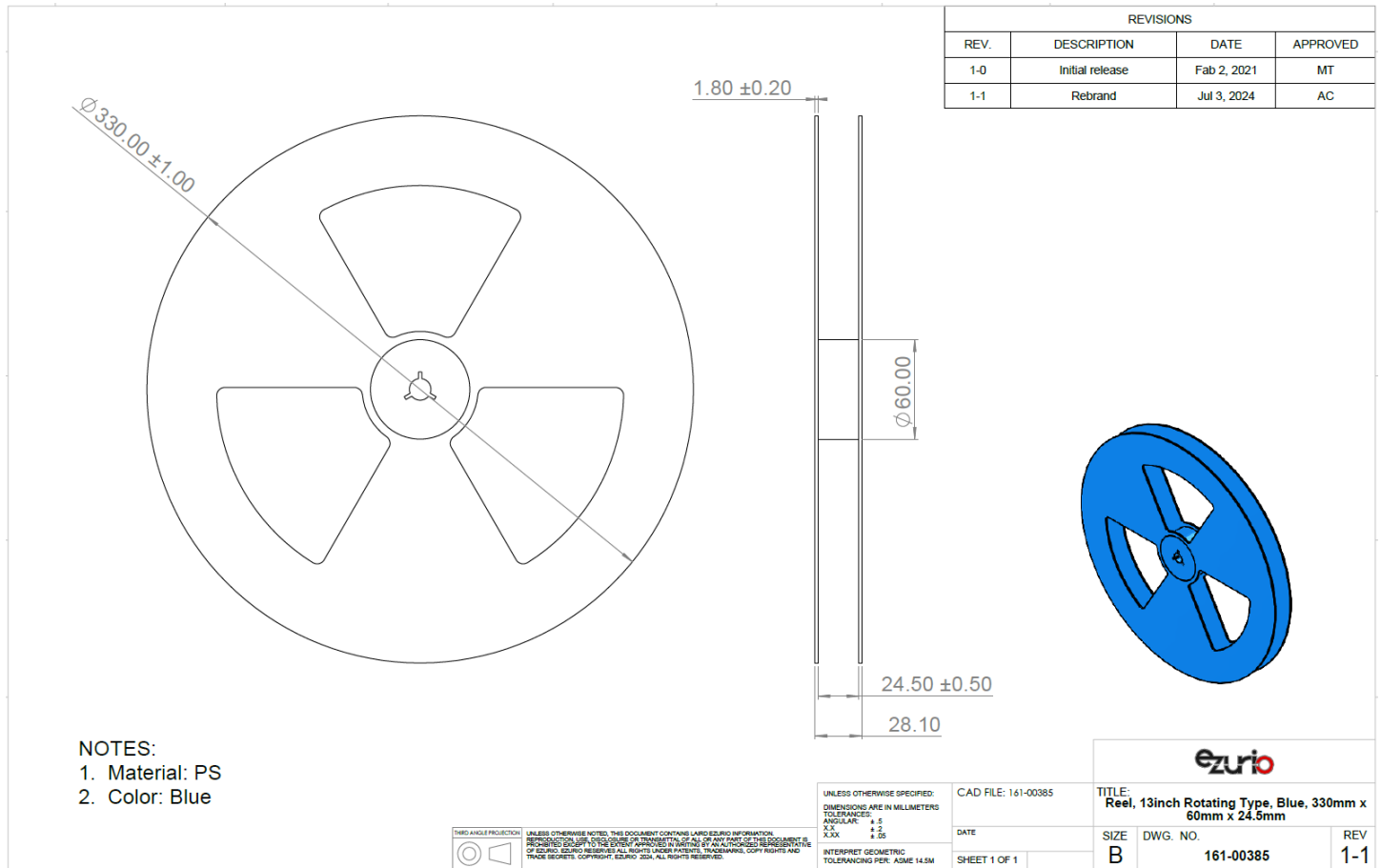


Figure 14: Sona TI351 Reel specifications, 161-00385

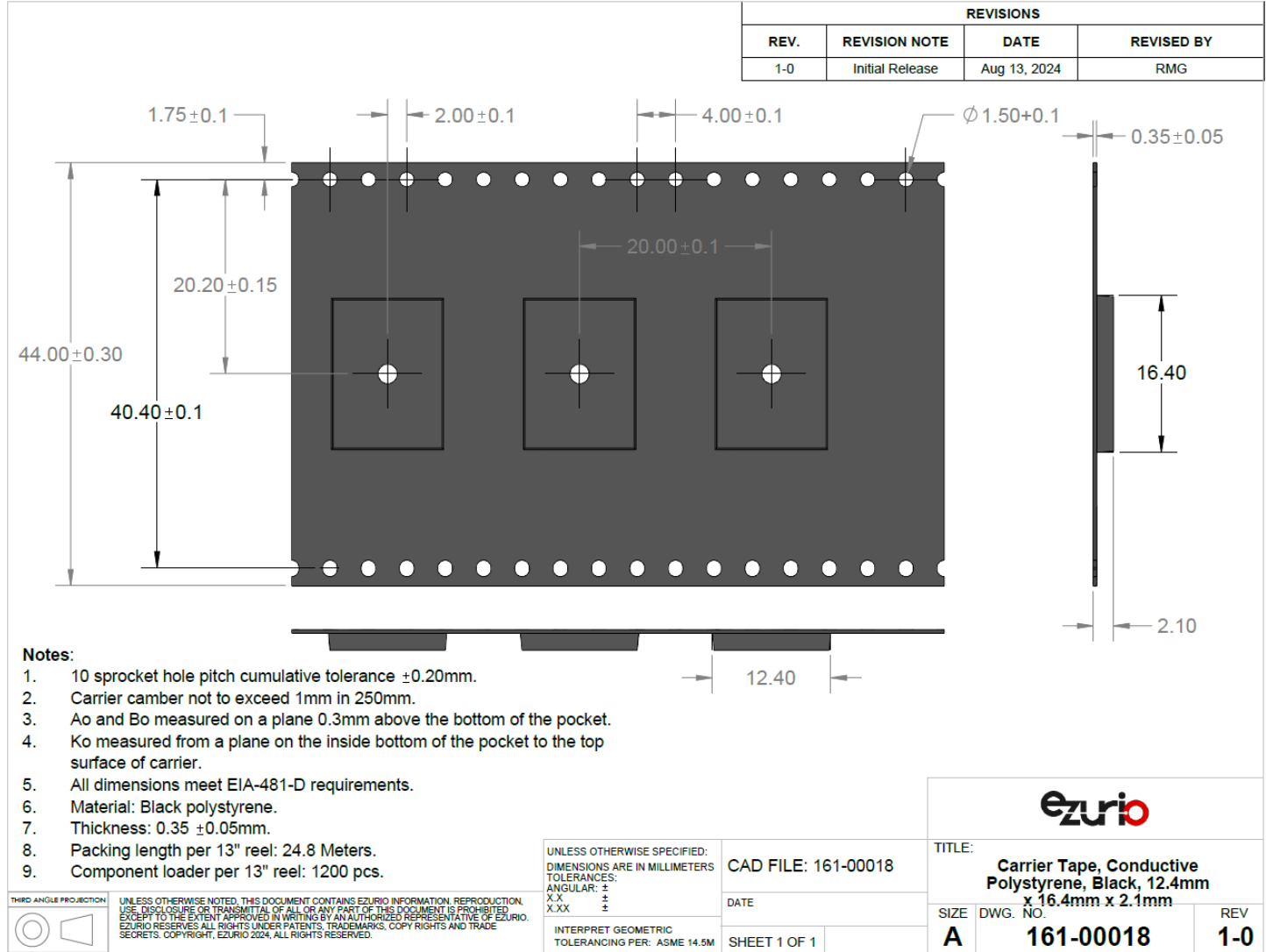


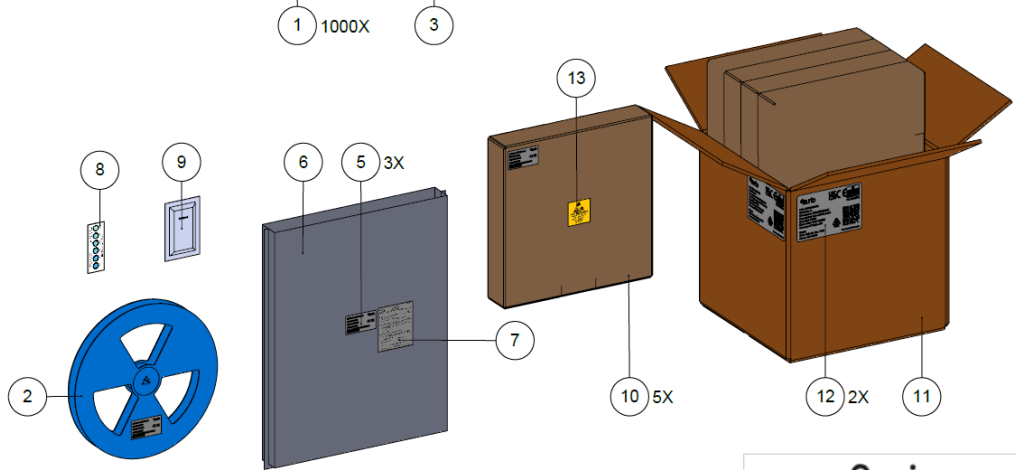
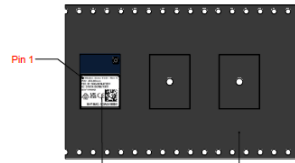
Figure 15: Sona TI351 Tape specifications, 161-00018

There are 1000 Sona TI351 modules taped in a reel (and packaged in a pizza box) and five boxes per carton (5,000 modules per carton). Reel, boxes, and carton are labeled with the appropriate labels.

NO.	ITEM NUMBER	REV.	DESCRIPTION	QTY.
1	453-00199	1-0	Module, Sona TI351, MHF4	1000
2	161-00385	1-1	Reel, 13inch Rotating Type, Blue, 330mm x 60mm x 24.5mm	1
3	161-00018	0-0	Carrier Tape, Conductive Polystyrene, Black, 12.4mm x 16.4mm x 2.1mm	1
4	161-00019	0-0	Cover Tape, Anti-static Polyester, 37.5mm x 0.055mm	1
5	160-00049	0-1	Label, Bag and Reel, Product Identifier, Sona TI351, 70mm x 40mm	3
6	161-00373	1-1	Bag, ESD and Moisture Barrier, Silver, 520mm x 420mm x 0.15mm	1
7	160-01816	1-1	Label, Blank Moisture Sensitivity Level, 95mm x 80mm	1
8	161-00387	1-1	Humidity Indicator Card, Minimum 60% RH, Six Spot Indication, 38mm x 105mm	1
9	161-00020	1-0	Desiccant, Silica Gel, 66g, 125mm x 80mm	1
10	161-00374	1-1	Box, Single-Wall Corrugated E Flute, 338mm x 343mm x 68mm	5
11	161-00375	1-1	Carton, Double-Wall, AB Flute, 368mm x 354mm x 362mm	1
12	160-00053	1-0	Label, Standard Shipping Box, CE Mark, Pictogram, UKCA, RCM, 150mm x 100mm	2
13	160-02075	1-1	Label, Caution ESD, Yellow, 51mm x 51mm	1

REVISIONS			
REV.	DESCRIPTION	DATE	APPROVED
1-0	Initial Release	Aug 14, 2024	RSW

Module Orientation



Notes:

- Put the RF Module in the carrier tape and cover the tape.
- Put the Reel, Desiccant, and Humidity Indicator Card in the ESD bag.
- Put the packed ESD bag (vacuum-sealed) in the box.
- Put five boxes in the carton. (If the carton is not full, insert empty boxes to consume the volume of the carton.)
- Module packaging quantity:  
Per Reel: 1000 PCS  
Per Carton: 5000 PCS



UNLESS OTHERWISE NOTED, THIS DOCUMENT CONTAINS LATENT ESD/RF INFORMATION. REPRODUCTION, USE, CIRCULATION OR TRANSMISSION OF ALL OR ANY PART OF THIS DOCUMENT IS PROHIBITED EXCEPT AS THE EXPLICIT APPROVAL IN WRITING OF AN AUTHORIZED REPRESENTATIVE OF EZURIO. EZURIO RESERVES ALL RIGHTS UNDER PATENTS, TRADEMARKS, COPYRIGHTS AND TRADE SECRETS. COPYRIGHT: EZURIO 2024. ALL RIGHTS RESERVED.


UNLESS OTHERWISE SPECIFIED:  
DIMENSIONS ARE IN MILLIMETERS  
TOLERANCES:  
ANGULAR: # 5  
XXX # 2  
XXX # 1  
INTERPRET GEOMETRIC TOLERANCING PER: ASME Y14.5M

CAD FILE: 453-00199R  
DATE  
SHEET 1 OF 1 Unit: mm

TITLE: Module, Sona TI351, MHF4, Tape and Reel		
SIZE B	DWG. NO. 453-00199R	REV 1-0

Figure 16: Sona TI351 packaging processes, 453-00199R

The following labels are located on the antistatic bag.



**Caution**  
This bag contains  
**MOISTURE-SENSITIVE DEVICES**

LEVEL

If blank, see adjacent bar code label

1. Calculated shelf life in sealed bag : 12 months at <math><40^{\circ}\text{C}</math> and <math><90\%</math> relative humidity (RH)
2. Peak package body temperature: \_\_\_\_\_ $^{\circ}\text{C}$   
If blank, see adjacent bar code label
3. After bag is opened, devices that will be subjected to reflow solder or other high temperature process must be
  - a) Mounted within: \_\_\_\_\_ hours of factory conditions  
If blank, see adjacent bar code label  
 $\leq 30^{\circ}\text{C}/60\% \text{ RH}$ , or
  - b) Stored per J-STD-033
4. Devices require bake, before mounting, if:
  - a) Humidity Indicator Card reads > 10% for level 2a - 5a devices or > 60% for level 2 devices when read at  $23 \pm 5^{\circ}\text{C}$
  - b) 3a or 3b are not met.
5. If baking is required, refer to IPC/JEDEC J-STD-033 for bake procedure.

Bag Seal Date: \_\_\_\_\_  
If blank, see adjacent bar code label






Note: Level and body temperature defined by IPC/JEDEC J-STD-020

Figure 17: Sona TI351 Moisture Sensitivity Level Label, 160-01816


The following label is placed on the reel, bag and pizza box.




**Ezurio Part NO: 453-XXXXXR**


**Rev X**

  
P/N: XXXXXXXXXXXX  
  
Quantity: XXX PCS  
  
Date Code: SSYYWWD  
  
PACKING NO: RSNYYWSSSS  


**Made in China**





BE	BG	CZ	NL	CH	TR
DK	DE	EE	PT	LI	IS
IE	EL	ES	SK	SE	FI
FR	HR	IT	UK(NI)	RO	SI
CY	LV	LT	NO	PL	AT
LU	HU	MT			

Figure 18: Sona TI351 Reel, Bag, and Box Product Identifier Label, 160-00049

The following package label is located on adjacent sides of the master carton.

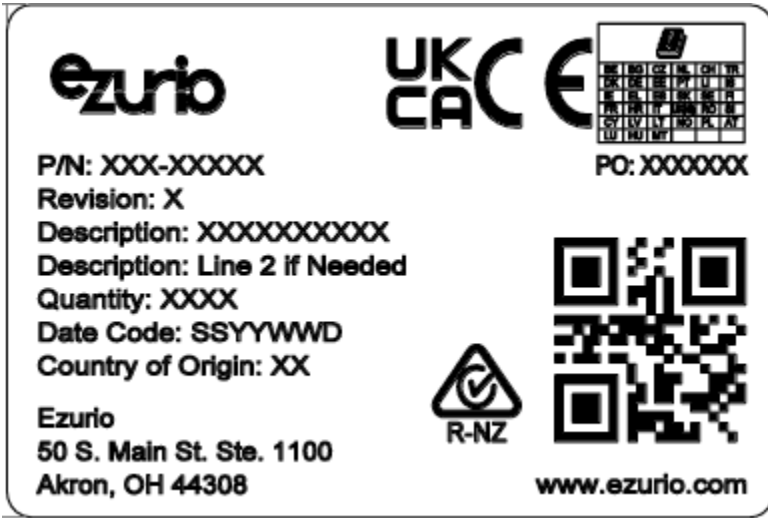


Figure 19: Sona TI351 Carton Product Identifier Label, 160-00053

15.2.2 M.2 2230 Key-E Card

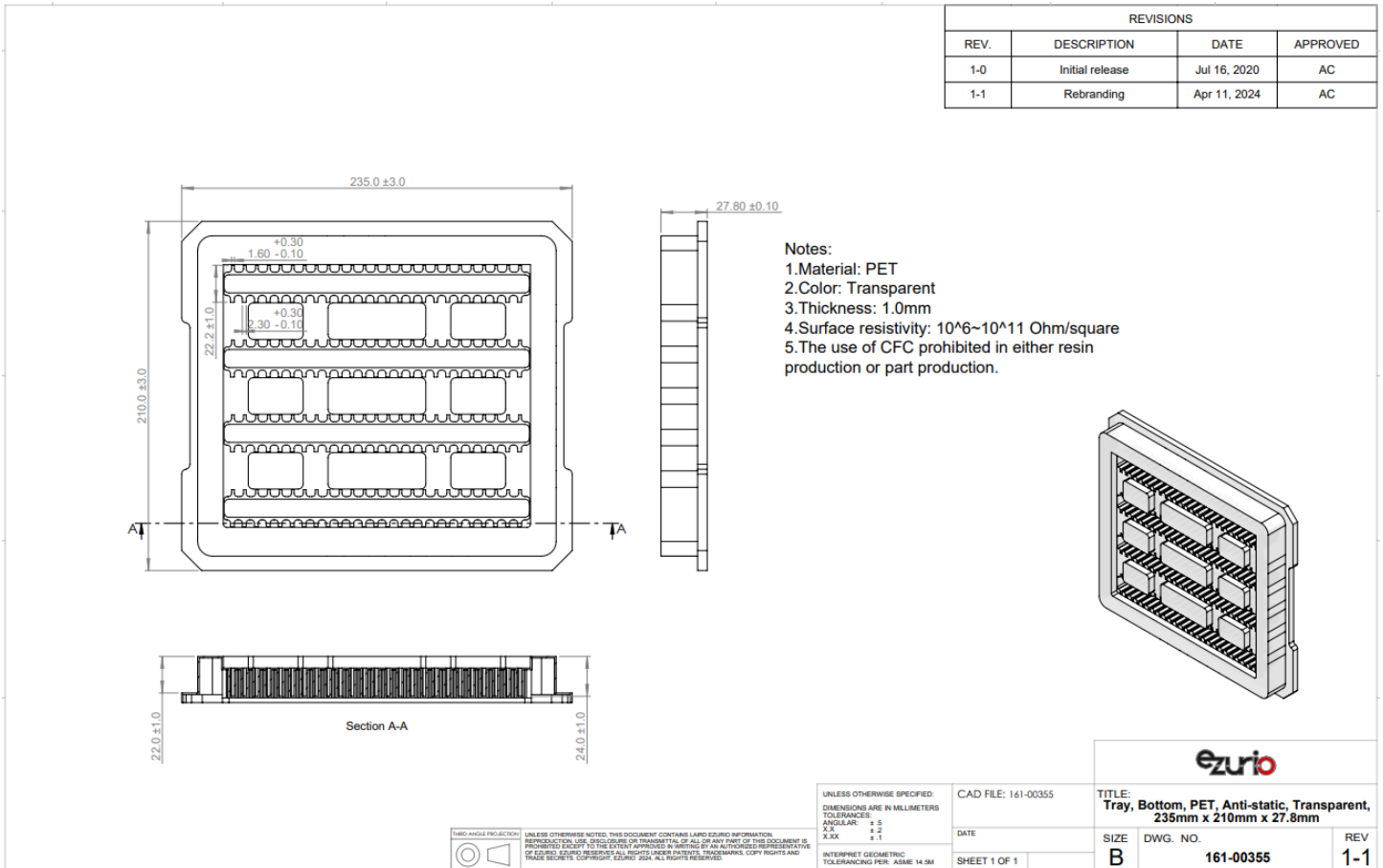
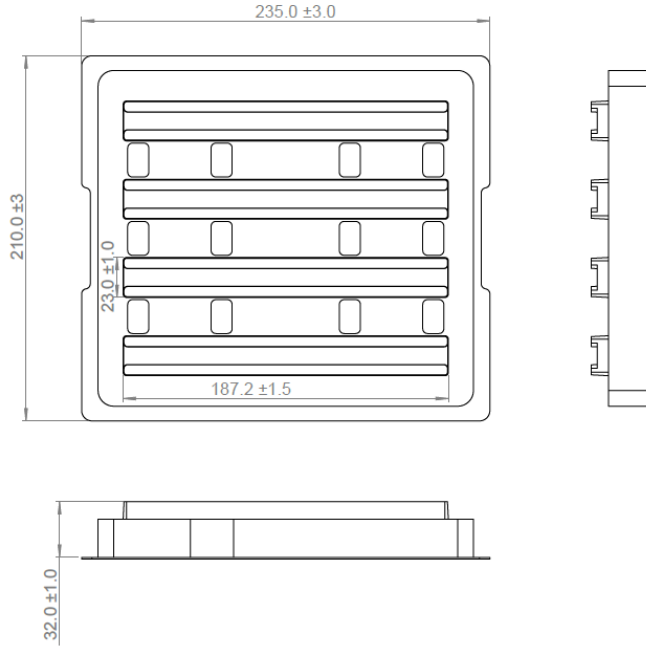
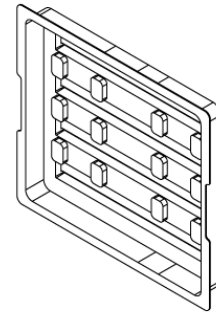


Figure 20: Sona TI351 M.2 2230 Shipping Tray, Bottom, 161-00355

REVISIONS			
REV.	DESCRIPTION	DATE	APPROVED
1.0	Initial release	Jul 16, 2020	AC
1-1	Templates logo change	Mar 21, 2024	AC



- Notes:
1. Material: PET
  2. Color: Transparent
  3. Thickness: 1.0mm
  4. Surface resistivity:  $10^6$ ~ $10^{11}$  Ohm/square
  5. The use of CFC prohibited in either resin production or part production.



UNLESS OTHERWISE NOTED, THIS DOCUMENT CONTAINS LAIRD EZURIO INFORMATION.  
 REPRODUCTION, DISSEMINATION OR TRANSMITTAL OF ALL OR ANY PART OF THIS DOCUMENT IS  
 PROHIBITED WITHOUT THE EXPRESS APPROVAL IN WRITING BY AN AUTHORIZED REPRESENTATIVE  
 OF EZURIO. EZURIO RESERVES ALL RIGHTS UNDER PATENTS, TRADEMARKS, COPY RIGHTS AND  
 TRADE SECRETS. COPYRIGHT, EZURIO 2024. ALL RIGHTS RESERVED.

UNLESS OTHERWISE SPECIFIED:  
 DIMENSIONS ARE IN MILLIMETERS  
 TOLERANCES:  
 ANGULAR: ± 5  
 XX ± 2  
 X.XX ± 1  
 INTERPRET GEOMETRIC  
 TOLERANCING PER: ASME 14.5M

CAD FILE: 161-00356  
 DATE  
 SHEET 1 OF 1

TITLE: Tray, Top, PET, Anti-static, Transparent, 235mm x 210mm x 32mm		
SIZE B	DWG. NO. 161-00356	REV 1-1

Figure 19: Sona TI351 M.2 2230 Shipping Tray, Top, 161-00356

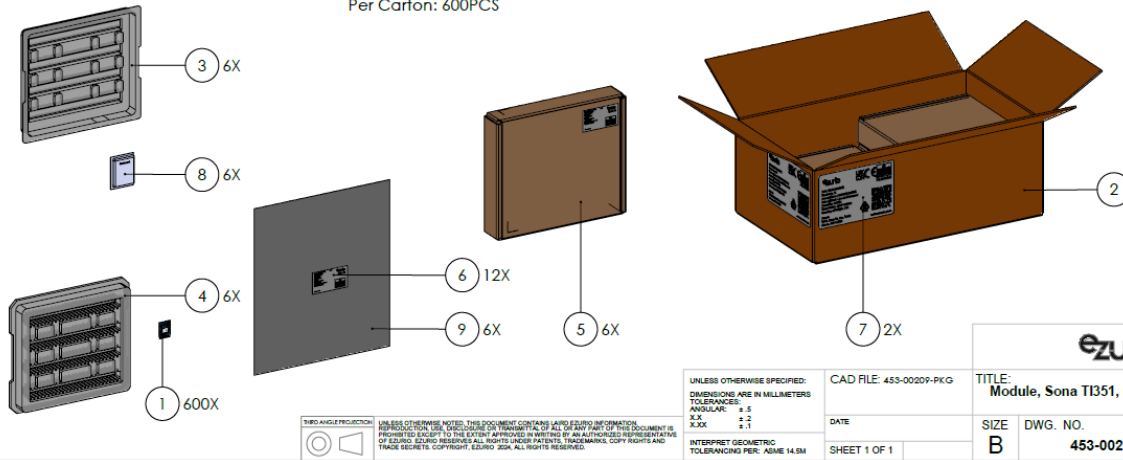
NO.	ITEM NUMBER	REV.	DESCRIPTION	QTY.
1	453-00209	1-0	Module, Sona TI351, M.2 2230	600
2	161-00359	1-1	Carton, Kraft, AB Flute, 455mm x 288mm x 170mm	1
3	161-00356	1-1	Tray, Top, PET, Anti-static, Transparent, 235mm x 210mm x 32mm	6
4	161-00355	1-1	Tray, Bottom, PET, Anti-static, Transparent, 235mm x 210mm x 27.8mm	6
5	161-00357	1-1	Box, Kraft, B Flute, 252mm x 217mm x 41mm	6
6	160-00049	1-0	Label, Bag and Reel, Product Identifier, Sona TI351, 70mm x 40mm	12
7	160-00053	1-0	Label, Standard Shipping Box, CE Mark, Pictogram, UKCA, RCM, 150mm x 100mm	2
8	161-00021	1-0	Desiccant, Silica Gel, 5g, 60mm x 45mm	6
9	161-00022	1-0	Bag, ESD and Moisture Barrier, Silver, 270mm x 310mm x 0.15mm	6

REVISIONS			
REV.	REVISION NOTE	RELEASED DATE	REVISED BY
0-1	Initial Release	Oct 2, 2024	RG

**Notes:**

- Put the Module(s) and Desiccant(s) in the bottom tray.
- Cover the top tray.
- Put the packed tray in the ESD bag.
- Put the packed ESD bag (vacuum) in the box.
- Put six boxes in the carton.
- Module packaging quantity:

Per Tray: 100 PCS  
Per Carton: 600PCS




UNLESS OTHERWISE SPECIFIED: DIMENSIONS ARE IN MILLIMETERS TOLERANCES: ANGULAR: ± 5 XX ± 2 XXX ± 1 INTERPRET GEOMETRIC TOLERANCING PER: ASME 14.5M	CAD FILE: 453-00209-PKG DATE	TITLE: Module, Sona TI351, M.2 2230, Packaging SIZE DWG. NO. REV B 453-00209-PKG 0-1
SHEET 1 OF 1		


Figure 20: Sona TI351 M.2 2230 Packaging Process, 453-00209-PKG

The following label is placed on the bag and the inner box.


**Ezurio Part NO: 453-XXXXXR** **Rev X**




**P/N: XXXXXXXXXX**




**Quantity: XXX PCS**





**Date Code: SSYYWWD**



**PACKING NO: RSNYYWSSSS**



**Made in China**


					
BE	BG	CZ	NL	CH	TR
DK	DE	EE	PT	LI	IS
IE	EL	ES	SK	SE	FI
FR	HR	IT	UK(NI)	RO	SI
CY	LV	LT	NO	PL	AT
LU	HU	MT			

Figure 21: Sona TI351 M.2 2230 Bag and Box Product Identifier Label, 160-00049

The following label is located on the adjacent sides of the master carton.



Figure 22: Sona TI351 Carton Product Identifier Label, 160-00053

### 15.3 Required Storage Conditions

#### 15.3.1 Prior to Opening the Dry Packing

The following are required storage conditions *prior to opening the dry packing*:

- Normal temperature: 5~40 °C
- Normal humidity: 80% (Relative humidity) or less
- Storage period: One year or less

**Note:** Humidity means relative humidity.

#### 15.3.2 After Opening the Dry Packing

The following are required storage conditions *after opening the dry packing* (to prevent moisture absorption):

- Storage conditions for one-time soldering:
  - Temperature: 5-25°C
  - Humidity: 60% or less
  - Period: 72 hours or less after opening
- Storage conditions for two-time soldering
  - Storage conditions following opening and prior to performing the 1<sup>st</sup> reflow:
    - Temperature: 5-25°C
    - Humidity: 60% or less
    - Period: A hours or less after opening
  - Storage conditions following completion of the 1<sup>st</sup> reflow and prior to performing the 2<sup>nd</sup> reflow
    - Temperature: 5-25°C
    - Humidity: 60% or less
    - Period: B hours or less after completion of the 1<sup>st</sup> reflow

**Note:** Should keep A+B within 72 hours.

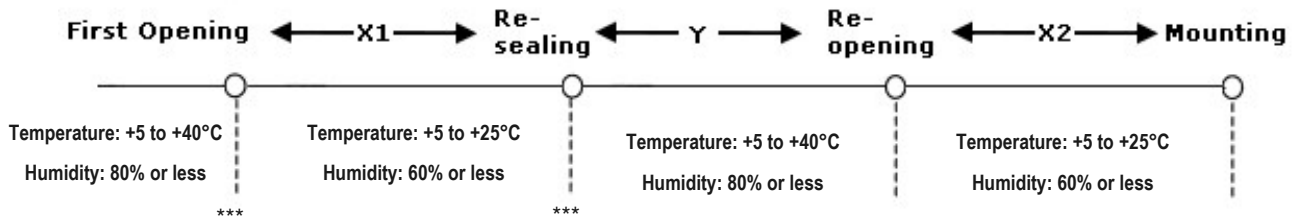
### 15.3.3 Temporary Storage Requirements after Opening

The following are temporary storage requirements after opening:

- Only re-store the devices once prior to soldering.
- Use a dry box or place desiccant (with a blue humidity indicator) with the devices and perform dry packing again using vacuumed heat-sealing.

The following indicate the required storage period, temperature, and humidity for this temporary storage:

- Storage temperature and humidity:



\*\*\* - External atmosphere temperature and humidity of the dry packing

- Storage period:
  - X1+X2 - Refer to **After Opening the Dry Packing** storage requirements. Keep is X1+X2 within 72 hours.
  - Y - Keep within two weeks or less.

### 15.4 Baking Conditions

Baking conditions and processes for the module follow the J-STD-033 standard which includes the following:

- The calculated shelf life in a sealed bag is 12 months at < 40°C and < 80% relative humidity.
- Once the packaging is opened, the SiP must be mounted (per MSL4/Moisture Sensitivity Level 4) within 72 hours at < 30 °C and < 60% relative humidity.

If the SiP is not mounted within 72 hours or if, when the dry pack is opened, the humidity indicator card displays > 10% humidity, then the product must be baked for 48 hours at 125 °C (±5 °C).

## 16 Surface Mount Conditions

The following soldering conditions are recommended to ensure device quality.

### 16.1 Soldering

**Note:** When soldering, the stencil thickness should be  $\geq 0.1$  mm.

Convection reflow or IR/Convection reflow (one-time soldering or two-time soldering in air or nitrogen environment)

Measuring point – IC package surface

Temperature profile:

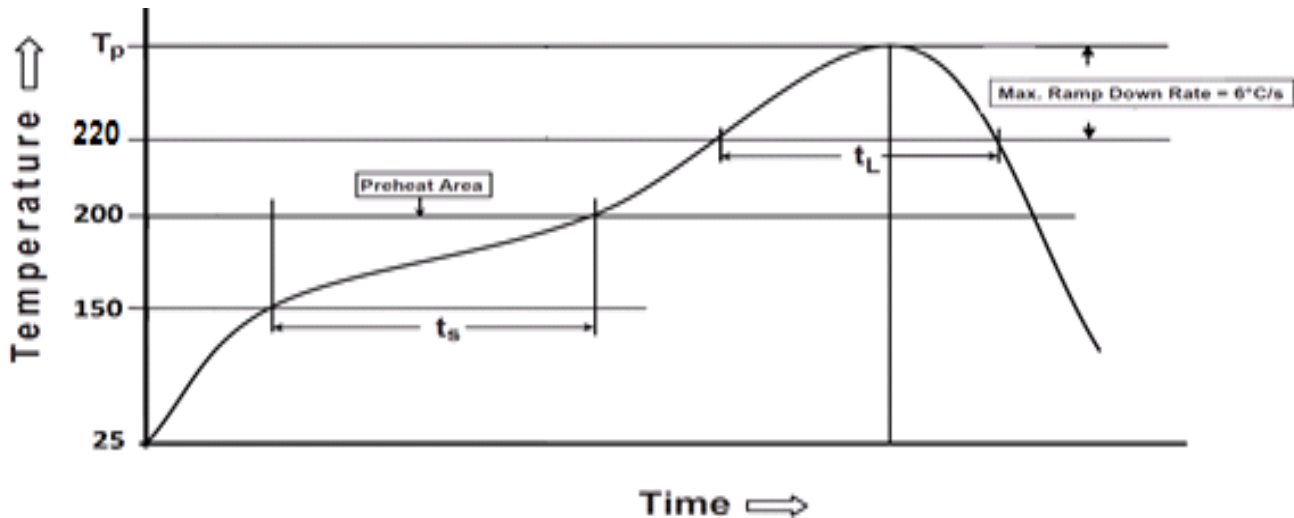


Figure 23: Temperature profile

- Solder paste alloy: SAC305 (Sn96.5 / Ag3.0 / Cu 0.5)
- Pre-heat temperature: 150°C ~ 200°C; Soak time: 60 second ~ 120 second
- Peak temperature: 235°C ~ 250°C
- Time above 220°C: 40 second ~ 90 second
- Optimal cooling rate < 3°C/second
- The oxygen concentration < 2000 ppm

#### 16.1.1 Cautions When Removing the M.2 1216 from the Platform for RMA

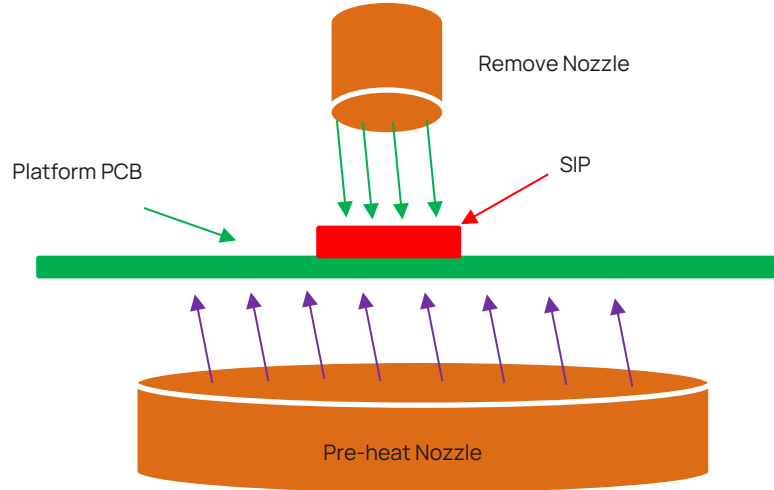
- Bake the platform before removing the Sona TI351 module from the platform. Reference baking conditions.
- Remove the Sona TI351 module by using a hot air gun. This process should be carried out by a skilled technician.

Recommended conditions:

- One-side component platform:
  - Set the hot plate at 280°C.
  - Put the platform on the hot plate for 8~10 seconds.
  - Remove the device from platform.



- Two-side components platform:
  - Use two hot air guns.
  - On the bottom, use a pre-heated nozzle (temp setting of 200~250°C) at a suitable distance from the platform PCB.
  - On the top, apply a remove nozzle (temp setting of 330°C). Heat until device can be removed from platform PCB.



- Remove the residue solder under the bottom side of device. (**Note:** Alternate module pictured as an example)



(Not accepted for RMA)

Figure 27: Example M.2 1216 with residue solder on the bottom



(Accepted for RMA analysis)

Figure 28: Sona TI351 module without residue solder

- Remove and clean the residue flux as needed.

**16.1.2 Precautions for Use**

- Opening/handling/removing must be done on an anti-ESD treated workbench. All workers must also have undergone anti-ESD treatment.
- The devices should be mounted within one year of the date of delivery.
- The Sona TI351 1216 modules are MSL level 4 rated.

## 17 Reliability Test

The Sona TI351 modules were tested for reliability. Test items and the corresponding standards are shown in the following sections.

### 17.1 Environmental and Mechanical

The following are the reliability test procedures and results.

**Table 27: Sona TI351 M.2 1216 Solder-down Module Reliability Test Items and Standards**

Test Item	Specification	Standard	Test Result
Thermal Shock	<ol style="list-style-type: none"> <li>Temperature: -40 ~ 85°C</li> <li>Ramp time: Less than 10 seconds.</li> <li>Dwell Time: 10 minutes</li> <li>Number of Cycles: 500 times</li> </ol>	*JESD22-A106 *IEC 60068-2-14 for dwell time and number of cycles	PASS
Vibration Non-operating Unpackaged device	<ol style="list-style-type: none"> <li>Vibration Wave Form: Sine Waveform</li> <li>Vibration frequency / Displacement: 20-80 Hz/1.5mm</li> <li>Vibration frequency / Acceleration: 80-2000 Hz/20g</li> <li>Cycle Time: 4 min/cycle</li> <li>Number of Cycles: 4 cycle/axis</li> <li>Vibration Axes : X, Y and Z (Rotate each axis on vertical vibration table)</li> </ol>	JEDEC 22-B103B (2016)	PASS
Mechanical Shock Non-operating Unpackaged device	<ol style="list-style-type: none"> <li>Pulse shape: Half-sine waveform</li> <li>Impact acceleration: 1500 g</li> <li>Pulse duration: 0.5 ms</li> <li>Number of shocks: 30 shocks (5 shocks for each face)</li> <li>Orientation: Bottom, top, left, right, front and rear faces</li> </ol>	JEDEC 22-B110B.01 (2019)	PASS

**Table 28: Sona TI351 M.2 2230 E-Key Module Reliability Test Item and Standards**

Test Item	Specification	Standard	Test Result
Thermal Shock	<ol style="list-style-type: none"> <li>Temperature: -40 ~ 85°C</li> <li>Ramp time: Less than 10 seconds.</li> <li>Dwell Time: 10 minutes</li> <li>Number of Cycles: 500 times</li> </ol>	*JESD22-A106 *IEC 60068-2-14 for dwell time and number of cycles	PASS
Vibration Non-operating Unpackaged device	<ol style="list-style-type: none"> <li>Vibration Wave Form: Sine Waveform</li> <li>Vibration frequency / Displacement: 20-80 Hz/1.5mm</li> <li>Vibration frequency / Acceleration: 80-2000 Hz/20g</li> <li>Cycle Time: 4 min/cycle</li> <li>Number of Cycles: 4 cycle/axis</li> <li>Vibration Axes : X, Y and Z (Rotate each axis on vertical vibration table)</li> </ol>	JEDEC 22-B103B (2016)	PASS
Mechanical Shock Non-operating Unpackaged device	<ol style="list-style-type: none"> <li>Pulse shape: Half-sine waveform</li> <li>Impact acceleration: 1500 g</li> <li>Pulse duration: 0.5 ms</li> <li>Number of shocks: 30 shocks (5 shocks for each face)</li> <li>Orientation: Bottom, top, left, right, front and rear faces</li> </ol>	JEDEC 22-B110B.01 (2019)	PASS

## 17.2 Reliability Prediction

The predicted method refers to Telcordia SR-232 Issue 4 (2016)

**Table 29: Sona TI351 MTBF analysis**

Ezurio Part Number	Environment	Test Result 45 °C (Hours)
453-00199R		
453-00199C	Ground, Fixed, Uncontrolled	10252962.09
453-00200R	Ground, Mobile	5234443.907
453-00200C		

Ezurio Part Number	Environment	Test Result 85 °C (Hours)
453-00199R		
453-00199C	Ground, Fixed, Uncontrolled	1988175.12
453-00200R	Ground, Mobile	1014808.30
453-00200C		

Ezurio Part Number	Environment	Test Result 45 °C (Hours)
453-00209	Ground, Fixed, Uncontrolled	4167380.48
	Ground, Mobile	2693697.55

Ezurio Part Number	Environment	Test Result 85 °C (Hours)
453-00209	Ground, Fixed, Uncontrolled	701816.41
	Ground, Mobile	463835.06

## 18 Regulatory

**Note:** For complete regulatory information, refer to the Sona TI351 Regulatory Information document which is also available from the [Sona TI351 product page](#).

The Sona TI351 holds current certifications in the following countries (pending):

**Table 30: Sona TI351 Regulatory Certifications**

Country/Region	Regulatory ID
USA (FCC)	SQG-SONATI351
EU	N/A
UKCA	N/A
Canada (ISED)	3147A-SONATI351
Japan (MIC)	pending
Australia	N/A
New Zealand	N/A
Korea	pending

### 18.1 Certified Antennas

The Sona TI351 MHF4 (453-00199) module was tested with the antennas listed in the following table.

**Table 31: Sona TI351 MHF4 external certified antenna list**

Manufacturer	Model	Ezurio Part Number	Type	Connector	Peak Gain (dBi)	
					2.4GHz	5GHz
Ezurio (Laird Connectivity)	FlexPIFA	001-0021	PIFA	MHF4L	2.5	3.0
Ezurio (Laird Connectivity)	FlexPIFA	EFB2455A3S-15MH4L	PIFA	MHF4L	2.5	3.0
Ezurio (Laird Connectivity)	FlexPIFA 6E	EFB2471A3S-10MH4L	PIFA	MHF4L	2.2	3.9
Ezurio (Laird Connectivity)	Mini NanoBlade Flex	EMF2449A1-10MH4L	PCB Dipole	MHF4L	2.8	3.4
Ezurio (Laird Connectivity)	Mini NanoBlade Flex 6E	EMF2471A3S-10MH4L	PCB Dipole	MHF4L	2.4	4.4
Ezurio (Laird Connectivity)	NanoBlade	ENB2449A1-10MH4L	PCB Dipole	MHF4L	3.19	4.1
Joymax Electronics	Dipole	TWX-100BRSAX-2001 / TWX-100BRS3B	Dipole	RP-SMA	2	4.0

## 18.2 Sona TI351 (453-00200) Chip Antenna Performance Characteristics

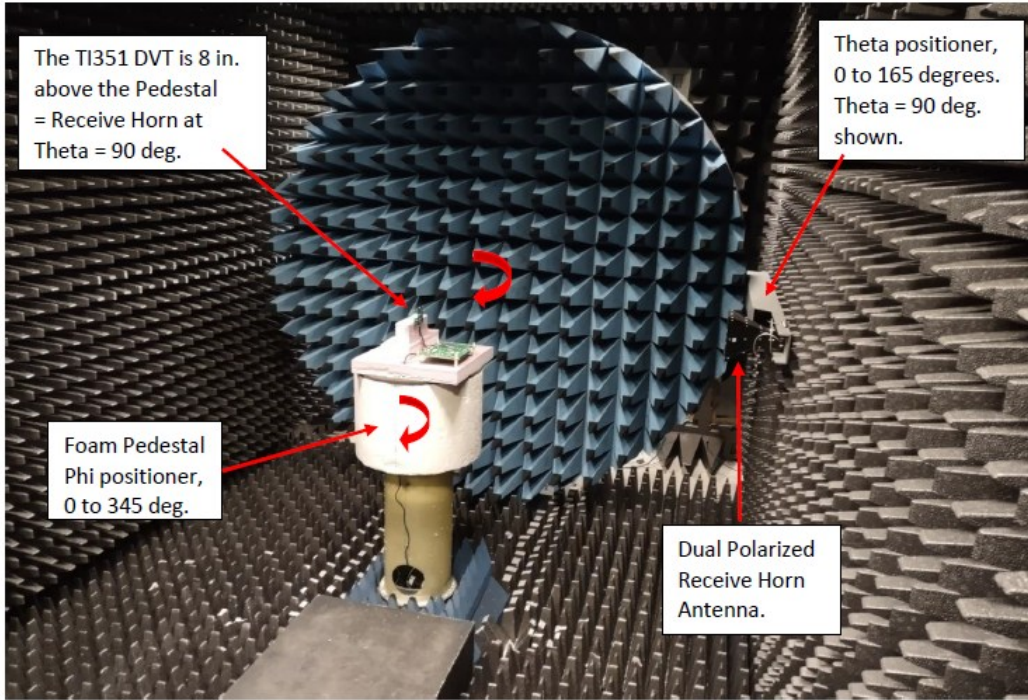
The TI351 Chip antenna module radiated performance depends on the host PCB layout. The TI351 development board (453-00200-K1) was used for the chip antenna tuning and 453-00200 antenna performance evaluation. To obtain similar performance, follow the guidelines presented in [Section 14 RF Layout Guidelines](#) for the chip antenna host PCB layout.

**Table 32: Sona TI351 Chip Antenna Radiated Performance**

Frequency (MHz)	TRP (dBm)	Total Gain (dBi)
2412	-6.02	0.93
2442	-5.43	1.96
2472	-5.71	1.99
5180	-5.31	-0.11
5500	-3.19	1.79
5825	-3.16	1.91

**Notes:** The set Antenna Power = 0 dBm

The Total Gain is calculated assuming the Antenna Power = 0 dBm



**TI351 SETUP:**

x-axis = Green  
y-axis = Red  
z-axis = Blue

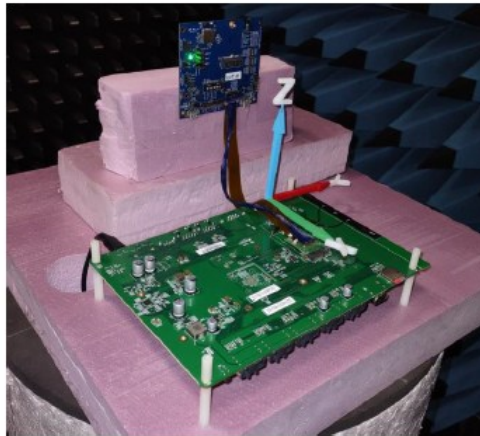
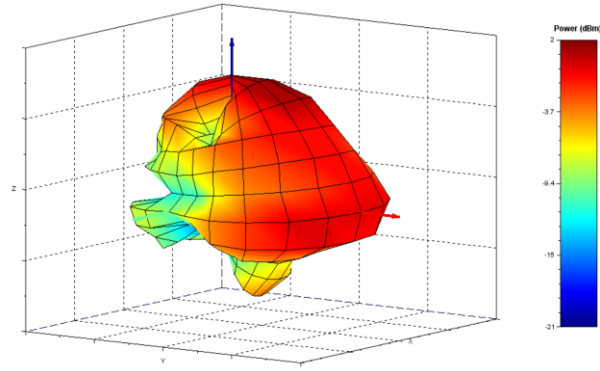


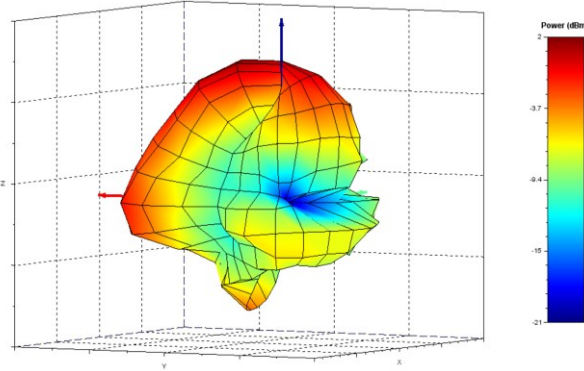
Figure 24: Sona TI351 Radiated Performance Measurement Setup

**18.2.1 2442 MHz Radiated Performance**

Radiated Power at 2442 MHz, TRP = -5.43 dBm, Max EIRP = 1.96 dBm

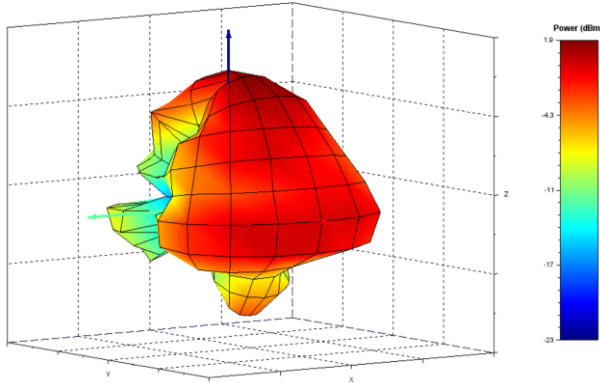


Radiated Power at 2442 MHz, TRP = -5.43 dBm, Max EIRP = 1.96 dBm

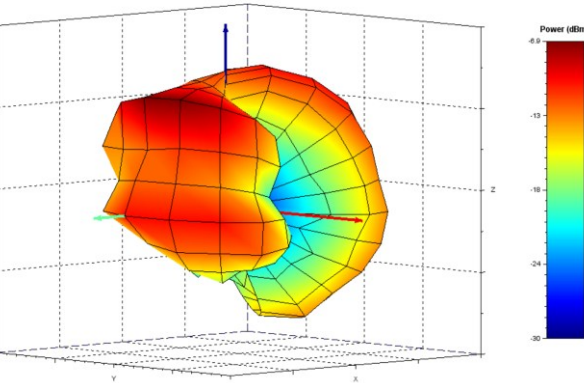


*Figure 30: Sona TI351 Total Gain Radiated Pattern at 2442 MHz*

Theta Polarization: Radiated Power at 2442 MHz, TRP = -5.91 dBm



Phi Polarization: Radiated Power at 2442 MHz, TRP = -15.19 dBm

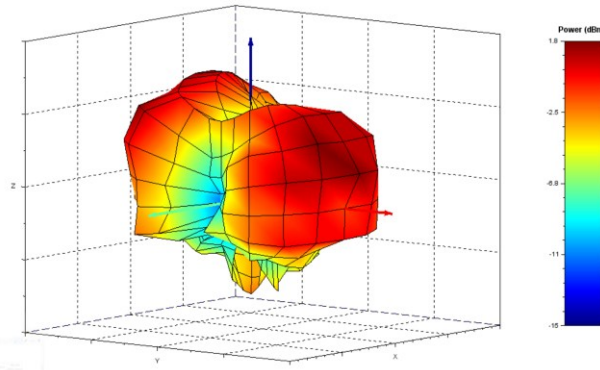


*Figure 31: Sona TI351 Theta and Phi Polarization Radiated Patterns at 2442 MHz*

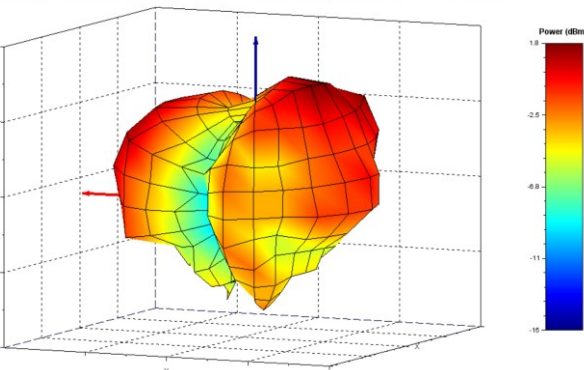
The patterns at other frequencies in the 2.4 GHz band exhibit the same radiated performance characteristics.

**18.2.2 5500 MHz Radiated Performance**

Radiated Power at 5500 MHz, TRP = -3.19 dBm, Max EIRP = 1.79 dBm

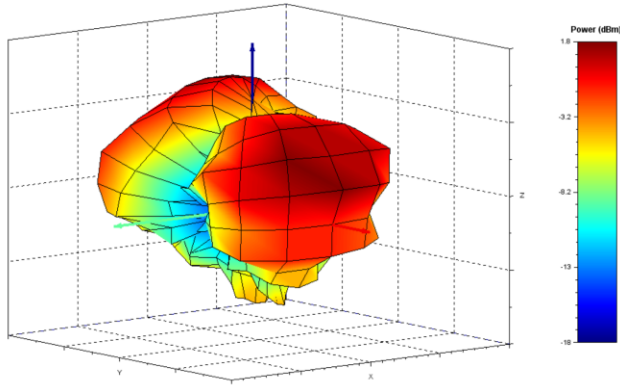


Radiated Power at 5500 MHz, TRP = -3.19 dBm, Max EIRP = 1.79 dBm



*Figure 32: Sona TI351 Total Gain Radiated Pattern at 5500 MHz*

Theta Polarization: Radiated Power at 5500 MHz, TRP = -4.76 dBm



Phi Polarization: Radiated Power at 5500 MHz, TRP = -8.38 dBm

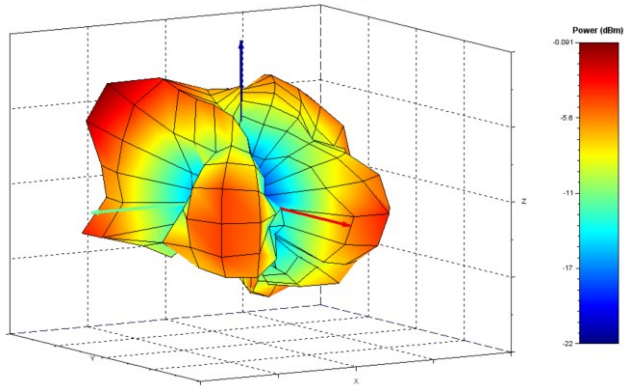


Figure 33: Sona TI351 Theta and Phi Polarization Radiated Patterns at 5500 MHz

The patterns at other frequencies in the 5 GHz band exhibit the same radiated performance characteristics.

## 19 Additional Information

Please contact your local sales representative or our support team for further assistance:

<b>Headquarters</b>	Ezurio 50 S. Main St. Suite 1100 Akron, OH 44308 USA
<b>Website</b>	<a href="http://www.ezurio.com/">www.ezurio.com/</a>
<b>Technical Support</b>	<a href="http://www.ezurio.com/resources/support">www.ezurio.com/resources/support</a>
<b>Sales Contact</b>	<a href="http://www.ezurio.com/contact">www.ezurio.com/contact</a>

**Note:** Information contained in this document is subject to change.

Ezurio's products are subject to standard [Terms & Conditions](#).

© Copyright 2025 Ezurio. All Rights Reserved. Patent pending. Any information furnished by Ezurio and its agents is believed to be accurate and reliable. All specifications are subject to change without notice. Responsibility for the use and application of Ezurio materials or products rests with the end user since Ezurio and its agents cannot be aware of all potential uses. Ezurio makes no warranties as to non-infringement nor as to the fitness, merchantability, or sustainability of any Ezurio materials or products for any specific or general uses. Ezurio or any of its affiliates or agents shall not be liable for incidental or consequential damages of any kind. All Ezurio products are sold pursuant to the Ezurio Terms and Conditions of Sale in effect from time to time, a copy of which will be furnished upon request. Nothing herein provides a license under any Ezurio or any third-party intellectual property right.