

TRZ 230VUC 2CO EMPTY

Weidmüller Interface GmbH & Co. KG
 Klingenbergstraße 26
 D-32758 Detmold
 Germany

www.weidmueller.com

Product image

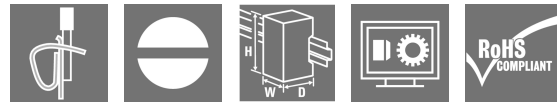
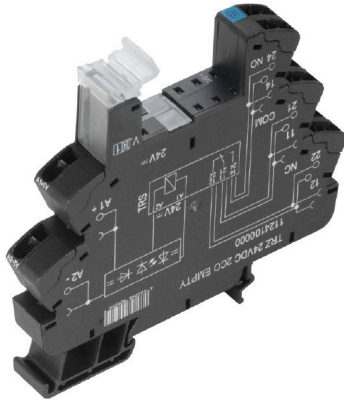

Similar to illustration

TERMSERIES empty sockets with:

- 2 CO contacts
- Unique multi-voltage input from 24 to 230 V UC
- Input voltages from 5 V DC to 230 V UC with coloured marking: AC: red, DC: blue, UC: white
- Due to high-quality design and no sharp edges no risk of injuries during installation
- Partition plates for optical separation and reinforcement of insulation

General ordering data

| | |
|------------|---|
| Version | TERMSERIES, Relay socket, Number of contacts: 2, CO contact, Rated control voltage: 230 V UC ±10%, Continuous current: 10 A, Tension-clamp connection |
| Order No. | 1124150000 |
| Type | TRZ 230VUC 2CO EMPTY |
| GTIN (EAN) | 4032248905867 |
| Qty. | 10 ST |

TRZ 230VUC 2CO EMPTY

Weidmüller Interface GmbH & Co. KG
 Klingenbergstraße 26
 D-32758 Detmold
 Germany

www.weidmueller.com

Technical data

Approvals

Approvals



| | |
|-------------------------|----------------------------|
| ROHS | Conform |
| UL File Number Search | UL Website |
| Certificate No. (cURus) | E223759 |

Dimensions and weights

| | | | |
|------------|---------|-----------------|-------------|
| Depth | 87.8 mm | Depth (inches) | 3.4567 inch |
| Height | 90.5 mm | Height (inches) | 3.563 inch |
| Width | 12.8 mm | Width (inches) | 0.5039 inch |
| Net weight | 43.5 g | | |

Temperatures

| | | | |
|---------------------|----------------|-----------------------|----------------|
| Storage temperature | -40 °C...85 °C | Operating temperature | -40 °C...60 °C |
|---------------------|----------------|-----------------------|----------------|

Environmental Product Compliance

| | |
|--------------------------------------|--------------------------------------|
| RoHS Compliance Status | Compliant with exemption |
| RoHS Exemption (if applicable/known) | 7a, 7cl |
| REACH SVHC | Lead 7439-92-1 |
| SCIP | 9e2cbc49-76d9-4611-b8ec-5b4f549a0aa9 |

Rated data UL

| | | | |
|---|--|------------------------------------|--------------------------|
| Ambient temperature (operational), max. | 60 °C | Output current derating (ohmic) | 6 A @ 60 °C, 8 A @ 50 °C |
| Connection cross-section AWG, min. | AWG 26 | Connection cross-section AWG, max. | AWG 14 |
| Type of conductor | rigid copper conductor, flexible copper conductor | Pollution severity level | 2 |
| Certificate No. (cURus) | E223759 | | |

Control side

| | | | |
|---------------------------------------|---------------|--|-----------|
| Rated control voltage | 230 V UC ±10% | Status indicator | Green LED |
| Protective circuit | Rectifier | Coil voltage of the replacement relay deviating from the rated control voltage | Yes |
| Coil voltage of the replacement relay | 110 V DC | | |

Load side

| | | | |
|-------------------------|--------------|--------------------|------|
| Rated switching voltage | 250 V AC | Continuous current | 10 A |
| Contact type | 2 CO contact | | |

General data

| | | | |
|------------------------------------|---------------------------|----------------|--|
| Operating altitude | ≤ 2000 m, above sea level | | |
| Rail | TS 35 | | |
| Colour | black | | |
| UL94 flammability rating component | Component | Housing | |
| | UL94 flammability rating | V-0 | |
| | Component | Retaining clip | |
| | UL94 flammability rating | V-0 | |

TRZ 230VUC 2CO EMPTY

Weidmüller Interface GmbH & Co. KG

Klingenbergstraße 26
D-32758 Detmold
Germany

www.weidmueller.com

Technical data

Insulation coordination

| | | | |
|--|------------------|---|------------------|
| Rated voltage | 300 V | Pollution severity | 2 |
| Surge voltage category | III | Clearance and creepage distances for control side - load side | ≥ 5.5 mm |
| Dielectric strength for control side - load side | 1.2 kVeff / 5 s | Dielectric strength of neighbouring contacts | 2.5 kVeff |
| Dielectric strength to mounting rail | 4 kVeff / 1 Min. | Impulse withstand voltage | 6 kV (1.2/50 µs) |
| Protection degree | IP20 | | |

Further details of approvals / standards

| | |
|-------------------------|---------|
| Certificate No. (cURus) | E223759 |
|-------------------------|---------|

Connection data

| | | | |
|---|--------------------------|---|----------------------|
| Wire connection method | Tension-clamp connection | Stripping length, rated connection | 8 mm |
| Clamping range, rated connection | 1.5 mm ² | Clamping range, min. | 0.14 mm ² |
| Clamping range, max. | 2.5 mm ² | Wire connection cross section AWG, min. | AWG 26 |
| Wire connection cross section AWG, max. | AWG 14 | Wire cross-section, solid, min. | 0.14 mm ² |
| Wire cross-section, solid, max. | 2.5 mm ² | Wire cross-section, solid, min. (AWG) | AWG 26 |
| Wire cross-section, solid, max. (AWG) | AWG 14 | Wire connection cross section, finely stranded, min. | 0.14 mm ² |
| Wire connection cross section, finely stranded, max. | 2.5 mm ² | Wire cross-section, finely stranded, min. (AWG) | AWG 26 |
| Wire cross-section, finely stranded, max. (AWG) | AWG 14 | Wire connection cross-section, finely stranded with wire-end ferrules DIN 46228/4, min. | 0.14 mm ² |
| Wire connection cross-section, finely stranded with wire-end ferrules DIN 46228/4, max. | 1.5 mm ² | Conductor cross-section, flexible, AEH (DIN 46228-1), min. | 0.14 mm ² |
| Conductor cross-section, flexible, AEH (DIN 46228-1), max. | 1.5 mm ² | Twin wire-end ferrules, min. | 0.5 mm ² |
| Twin wire-end ferrules, max. | 1 mm ² | Blade size | 0.6 x 3.5 mm |
| Pitch in mm (P) | 5.00 mm | | |

Classifications

| | | | |
|-------------|-------------|-------------|-------------|
| ETIM 6.0 | EC001456 | ETIM 7.0 | EC001456 |
| ETIM 8.0 | EC001456 | ETIM 9.0 | EC001456 |
| ETIM 10.0 | EC001456 | ECLASS 9.0 | 27-37-16-03 |
| ECLASS 9.1 | 27-37-16-03 | ECLASS 10.0 | 27-37-16-03 |
| ECLASS 11.0 | 27-37-16-03 | ECLASS 12.0 | 27-37-16-03 |
| ECLASS 13.0 | 27-37-16-03 | ECLASS 14.0 | 27-37-16-03 |
| ECLASS 15.0 | 27-37-16-03 | | |

TRZ 230VUC 2CO EMPTY

Weidmüller Interface GmbH & Co. KG
Klingenbergstraße 26
D-32758 Detmold
Germany

Drawings

www.weidmueller.com

Wiring diagram

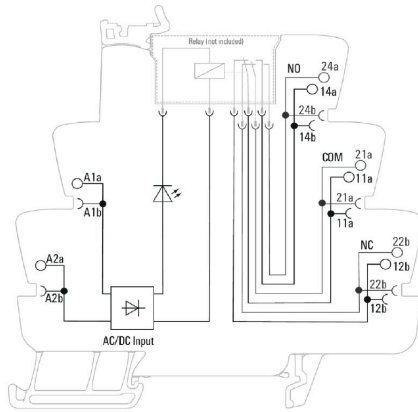

Dimensional drawing

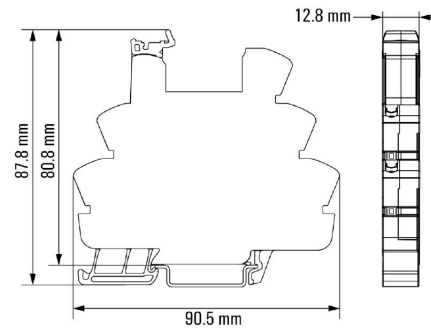

Miscellaneous

Type code TERMSERIES empty sockets

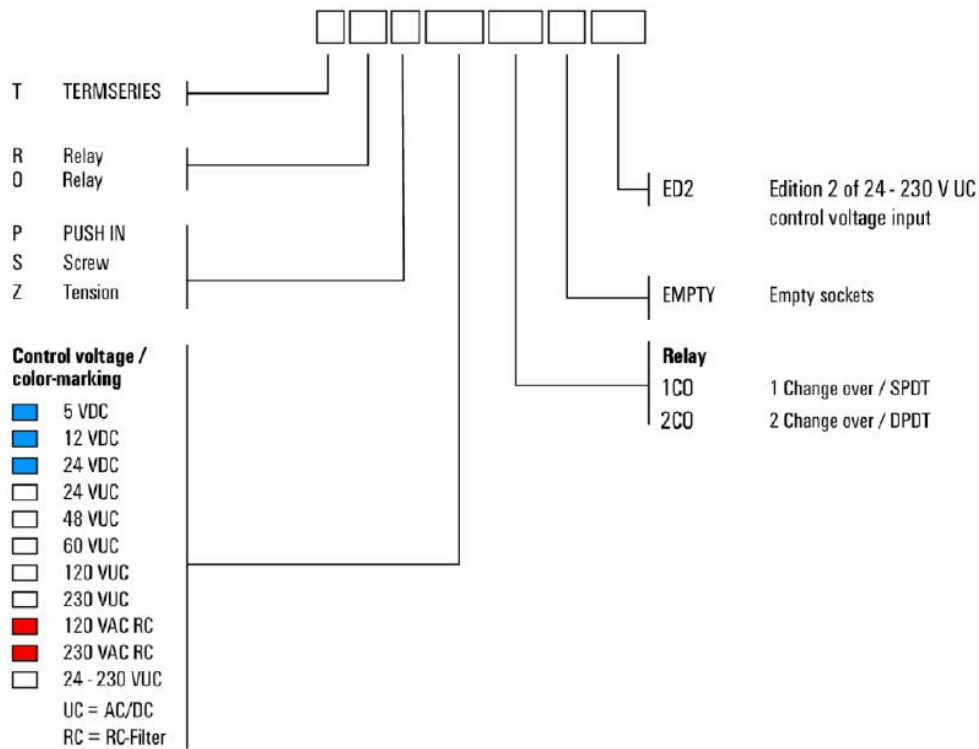

Type codes

TRZ 230VUC 2CO EMPTY

Weidmüller Interface GmbH & Co. KG
 Klingenbergstraße 26
 D-32758 Detmold
 Germany

www.weidmueller.com

Accessories

Partition plate



Versatile separation plates

Separation plates can be used to group together signals visually, to electrically isolate modules and to insert markings for a better overview. This makes them a particularly versatile accessory. Separation plates increase the clearance and creepage distances between two modules, thus increasing the rated insulation voltage between two modules to up to 600 V. Double separation plates can be marked with WAD5 or WS10/5 markers and enable continuous cross-connections. Installation is made easier with the perforations to individually break out the cross-connection channels.

- Partition plates visually separates groups from each other
- Indentations for individual breaking out the crossconnection channels
- Partition plates isolates between two modules by increasing the clearance and creepage distances of up to 600 V

General ordering data

| | | | |
|------------|----------------------------|-----------------------------|--|
| Type | TW TXS/TXZ R3.2 | Version | |
| Order No. | 1240800000 | TERMSERIES, Partition plate | |
| GTIN (EAN) | 4050118028188 | | |
| Qty. | 10 ST | | |

Supply module



Space-saving supply modules

Our supply terminals enable potentials to be fed at the input – e.g. neutral or minus potentials – or switched potentials to be fed at the output. In conjunction with precisely fitting cross-connections from the TERMSERIES, the connections for the cables on the relay module remain free for actuators or sensors. No additional feed-through terminal blocks are required, resulting in huge space savings in the panel. At the same time, the wiring is simplified as no double wire-end ferrules are required for the potential feed.

General ordering data

| | | | |
|------------|----------------------------|--|--|
| Type | TXP SUPPLY | Version | |
| Order No. | 2618940000 | TERMSERIES, Supply module, Number of contacts: 5, Continuous | |
| GTIN (EAN) | 4050118667592 | current: 10 A, PUSH IN | |
| Qty. | 10 ST | | |

TRZ 230VUC 2CO EMPTY

Weidmüller Interface GmbH & Co. KG
 Klingenbergstraße 26
 D-32758 Detmold
 Germany

www.weidmueller.com

Accessories

| | | |
|------------|----------------------------|--|
| Type | TXS SUPPLY | Version |
| Order No. | 1240780000 | TERMSERIES, Supply module, Number of contacts: 5, , Continuous |
| GTIN (EAN) | 4050118028140 | current: 10 A, Screw connection |
| Qty. | 10 ST | |
| Type | TXZ SUPPLY | Version |
| Order No. | 1240790000 | TERMSERIES, Supply module, Number of contacts: 5, , Continuous |
| GTIN (EAN) | 4050118028164 | current: 10 A, Tension-clamp connection |
| Qty. | 10 ST | |

Blank

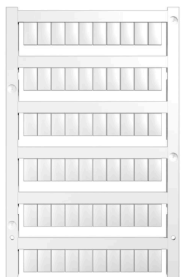

WS markers are the perfect match for the W-series connectors. Thanks to their system compatibility, the WS tags can also be used with the I-series and the Z-series. The large marking surfaces do not only permit long character strings but also multi-line text. WS markers are ideal for labels with long, customised character strings. Thanks to the proven MultiCard format, printing with PrintJet CONNECT oder/or Plotter is possible.

- Can be fitted in strips or individually
- Markers in proven MultiCard format

For custom printing: Please send us a file of our labeling software M-Print PRO or M-Print PRO Online (without installation) for your labeling specifications.

General ordering data

| | | |
|------------|----------------------------|--|
| Type | WS 10/6 M MC NE WS | Version |
| Order No. | 1818400000 | WS, Terminal marker, 10 x 6 mm, Pitch in mm (P): 6.00 Weidmueller, |
| GTIN (EAN) | 4032248310876 | Allen-Bradley, white |
| Qty. | 600 ST | |

Slotted screwdriver



Slotted screwdriver with rounded blade SD DIN 5265, ISO 2380/2, output to DIN 5264, ISO 2380/1. ChromTop tip, SoftFinish grip

General ordering data

| | | |
|------------|----------------------------|---|
| Type | SDS 0.6X3.5X100 | Version |
| Order No. | 2749340000 | Screwdriver, Blade width (B): 3.5 mm, Blade length: 100 mm, Blade thickness (A): 0.6 mm |
| GTIN (EAN) | 4050118895568 | |
| Qty. | 1 ST | |
| Type | SDIS SLIM 0.6X3.5X100 | Version |
| Order No. | 2749610000 | Mounting tool, Blade width (B): 3.5 mm, Blade length: 100 mm, Blade thickness (A): 0.6 mm |
| GTIN (EAN) | 4050118896350 | |
| Qty. | 1 ST | |

TRZ 230VUC 2CO EMPTY

Weidmüller Interface GmbH & Co. KG
 Klingenbergstraße 26
 D-32758 Detmold
 Germany

www.weidmueller.com

Accessories

Angled slotted screwdriver



General ordering data

| | | | |
|------------|----------------------------|--|--|
| Type | SD TO 0,6X3,0 | Version | |
| Order No. | 2749560000 | Screwdriver, Blade width (B): 3 mm, Blade length: 70 mm, Blade thickness (A): 0.6 mm | |
| GTIN (EAN) | 4050118895889 | | |
| Qty. | 1 ST | | |

Cross-connections



Adjustable cross-connections

Increase the flexibility of your cross-connections. The TERMSERIES CROSS-CONNECTION (TCC) enables individually adjustable cross-connections with up to 51 poles. The maximum number of pluggable poles has been increased to 32 poles. The strip material can be shortened to the required length very easily. The cross-connectors convince thanks to their easy handling and visibility as well as their universal connection possibilities. An additional web prevents the spring from deforming during assembly.

- Individually adjustable cross-connection with 51 poles
- Additional bar to avoid deformation of the spring
- Increased cross-connection – up to 32 poles possible
- Vibration resistance

General ordering data

| | | | |
|------------|----------------------------|-----------------------------|--|
| Type | TCC 6.4/51 RD | Version | |
| Order No. | 2556410000 | TERMSERIES, Cross-connector | |
| GTIN (EAN) | 4050118566925 | | |
| Qty. | 10 ST | | |
| Type | TCC 6.4/51 OR | Version | |
| Order No. | 2556370000 | TERMSERIES, Cross-connector | |
| GTIN (EAN) | 4050118566680 | | |
| Qty. | 10 ST | | |
| Type | TCC 6.4/51 BL | Version | |
| Order No. | 2556450000 | TERMSERIES, Cross-connector | |
| GTIN (EAN) | 4050118566963 | | |
| Qty. | 10 ST | | |
| Type | TCC 6.4/51 BK | Version | |
| Order No. | 2556490000 | TERMSERIES, Cross-connector | |
| GTIN (EAN) | 4050118567007 | | |
| Qty. | 10 ST | | |

TRZ 230VUC 2CO EMPTY

Weidmüller Interface GmbH & Co. KG
 Klingenbergstraße 26
 D-32758 Detmold
 Germany

www.weidmueller.com

Accessories

| | | |
|------------|----------------------------|-----------------------------|
| Type | TCC 6.4/2 OR | Version |
| Order No. | 2556350000 | TERMSERIES, Cross-connector |
| GTIN (EAN) | 4050118566826 | |
| Qty. | 10 ST | |
| Type | TCC 6.4/2 BL | Version |
| Order No. | 2556430000 | TERMSERIES, Cross-connector |
| GTIN (EAN) | 4050118566949 | |
| Qty. | 10 ST | |
| Type | TCC 6.4/2 BK | Version |
| Order No. | 2556470000 | TERMSERIES, Cross-connector |
| GTIN (EAN) | 4050118566987 | |
| Qty. | 10 ST | |
| Type | TCC 6.4/10 RD | Version |
| Order No. | 2556400000 | TERMSERIES, Cross-connector |
| GTIN (EAN) | 4050118566918 | |
| Qty. | 10 ST | |
| Type | TCC 6.4/10 OR | Version |
| Order No. | 2556360000 | TERMSERIES, Cross-connector |
| GTIN (EAN) | 4050118566673 | |
| Qty. | 10 ST | |
| Type | TCC 6.4/10 BL | Version |
| Order No. | 2556440000 | TERMSERIES, Cross-connector |
| GTIN (EAN) | 4050118566956 | |
| Qty. | 10 ST | |
| Type | TCC 6.4/10 BK | Version |
| Order No. | 2556480000 | TERMSERIES, Cross-connector |
| GTIN (EAN) | 4050118566994 | |
| Qty. | 10 ST | |
| Type | TCC 12.8/26 RD | Version |
| Order No. | 2556420000 | TERMSERIES, Cross-connector |
| GTIN (EAN) | 4050118566932 | |
| Qty. | 10 ST | |
| Type | TCC 12.8/26 OR | Version |
| Order No. | 2556380000 | TERMSERIES, Cross-connector |
| GTIN (EAN) | 4050118566697 | |
| Qty. | 10 ST | |
| Type | TCC 12.8/26 BL | Version |
| Order No. | 2556460000 | TERMSERIES, Cross-connector |
| GTIN (EAN) | 4050118566970 | |
| Qty. | 10 ST | |
| Type | TCC 12.8/26 BK | Version |
| Order No. | 2556500000 | TERMSERIES, Cross-connector |
| GTIN (EAN) | 4050118567014 | |
| Qty. | 10 ST | |
| Type | TCC 6.4/2 RD | Version |
| Order No. | 2556390000 | TERMSERIES, Cross-connector |
| GTIN (EAN) | 4050118566901 | |
| Qty. | 10 ST | |

TRZ 230VUC 2CO EMPTY

Weidmüller Interface GmbH & Co. KG

Klingenbergstraße 26

D-32758 Detmold

Germany

www.weidmueller.com

Accessories

Blank

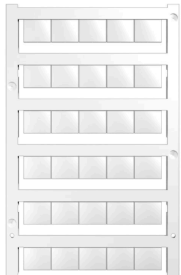

WS markers are the perfect match for the W-series connectors. Thanks to their system compatibility, the WS tags can also be used with the I-series and the Z-series. The large marking surfaces do not only permit long character strings but also multi-line text. WS markers are ideal for labels with long, customised character strings. Thanks to the proven MultiCard format, printing with PrintJet CONNECT oder/or Plotter is possible.

- Can be fitted in strips or individually
- Markers in proven MultiCard format

For custom printing: Please send us a file of our labeling software M-Print PRO or M-Print PRO Online (without installation) for your labeling specifications.

General ordering data

| | | | |
|------------|----------------------------|---|--|
| Type | WS 10/12 MC NE WS | Version | |
| Order No. | 1905970000 | WS, Terminal marker, 10 x 12 mm, Pitch in mm (P): 12.00 | |
| GTIN (EAN) | 4032248528127 | Weidmueller, white | |
| Qty. | 300 ST | | |

WS 12/6



WS/ DEK

MultiMark terminal markers use an innovative composite material made from two components. The hard base contour of the marker snaps securely into the connector. The elastic surface finish makes the marker easy to mount. This specially punched material enables the strips to be stretched to accommodate the slight variations in spacing that tend to add up, especially with long terminal blocks. Another advantage: the excellent printability of the surface material guarantees durable and wear-resistant labelling. A print resolution of 300 dpi also produces a very legible script.

Your benefits with MultiMark

- Firm hold and durable printing
- Continuous strips save installation time
- Easy mounting thanks to an innovative composite material
- Large label field for optimal legibility
- High flexibility thanks to manufacturer independence

General ordering data

| | | | |
|------------|----------------------------|--|--|
| Type | WS 12/6 MM WS | Version | |
| Order No. | 2007200000 | WS, Terminal marker, 12 x 6 mm, Weidmueller, white | |
| GTIN (EAN) | 4050118391886 | | |
| Qty. | 600 ST | | |