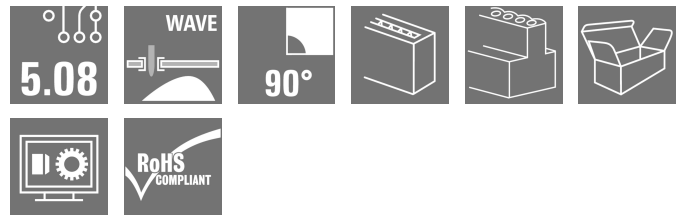
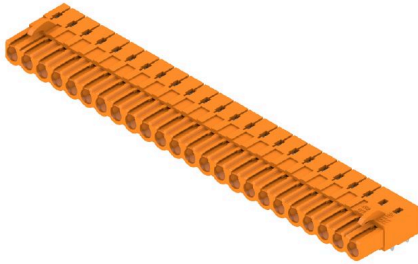

BLL 5.08/24/90 3.2 SN OR BX

Weidmüller Interface GmbH & Co. KG
Klingenbergstraße 26
D-32758 Detmold
Germany

www.weidmueller.com

Product image

Female header for PCB mounting. The solder pin length is optimised for wave flow soldering.

General ordering data

Version	PCB plug-in connector, female header, closed side, THT solder connection, 5.08 mm, Number of poles: 24, 90°, Solder pin length (l): 3.2 mm, tinned, orange, Box
Order No.	1648530000
Type	BLL 5.08/24/90 3.2 SN OR BX
GTIN (EAN)	4008190293000
Qty.	12 items
Product data	IEC: 400 V / 23 A UL: 300 V / 15 A
Packaging	Box

BLL 5.08/24/90 3.2 SN OR BX

Weidmüller Interface GmbH & Co. KG
Klingenbergstraße 26
D-32758 Detmold
Germany

www.weidmueller.com

Technical data

Approvals

Approvals



ROHS	Conform
UL File Number Search	UL Website
Certificate No. (UR)	E60693

Dimensions and weights

Net weight	26 g
------------	------

Environmental Product Compliance

RoHS Compliance Status	Compliant without exemption
REACH SVHC	No SVHC above 0.1 wt%

System specifications

Product family	OMNIMATE Signal - series BL/SL 5.08	Type of connection	Board connection
Mounting onto the PCB	THT solder connection	Pitch in mm (P)	5.08 mm
Pitch in inches (P)	0.200 "	Outgoing elbow	90°
Number of poles	24	Number of solder pins per pole	2
Solder pin length (l)	3.2 mm	Solder pin length tolerance	+0.1 / -0.3 mm
Solder pin dimensions	0.4 x 1.00 mm	Solder eyelet hole diameter (D)	1.3 mm
Solder eyelet hole diameter tolerance (D)+ 0,1 mm		L1 in mm	116.84 mm
L1 in inches	4.600 "	Number of rows	1
Pin series quantity	1	Touch-safe protection acc. to DIN VDE 57 106	Safe from back-of-hand touch
Touch-safe protection acc. to DIN VDE 0470	IP20 plugged	Protection degree	IP20
Volume resistance	≤5 mΩ	Can be coded	Yes
Plugging cycles	25	Plugging force/pole, max.	5 N
Pulling force/pole, max.	5 N		

Material data

Insulating material	PBT GF	Colour	orange
Colour chart (similar)	RAL 2000	Insulating material group	IIIa
Comparative Tracking Index (CTI)	≥ 200	Insulation resistance	108 Ω
Moisture Level (MSL)		UL 94 flammability rating	V-0
Contact material	Copper alloy	Contact surface	tinned
Layer structure of solder connection	4...6 μm Sn hot-dip tinned	Layer structure of plug contact	4...6 μm Sn hot-dip tinned
Storage temperature, min.	-40 °C	Storage temperature, max.	70 °C
Operating temperature, min.	-50 °C	Operating temperature, max.	100 °C
Temperature range, installation, min.	-25 °C	Temperature range, installation, max.	100 °C

Rated data acc. to IEC

tested acc. to standard	IEC 60664-1, IEC 61984	Rated current, min. number of poles (Tu=20°C)	23 A
Rated current, max. number of poles (Tu=20°C)	16 A	Rated current, min. number of poles (Tu=40°C)	20 A

BLL 5.08/24/90 3.2 SN OR BX

Weidmüller Interface GmbH & Co. KG

Klingenbergstraße 26
D-32758 Detmold
Germany

www.weidmueller.com

Technical data

Rated current, max. number of poles (Tu=40°C)	14 A	Rated voltage for surge voltage class / pollution degree II/2	400 V
Rated voltage for surge voltage class / pollution degree III/2	320 V	Rated voltage for surge voltage class / pollution degree III/3	250 V
Rated impulse voltage for surge voltage class/ pollution degree II/2	4 V	Rated impulse voltage for surge voltage class/ pollution degree III/2	4 kV
Rated impulse voltage for surge voltage class/ contamination degree III/3	4 kV	Short-time withstand current resistance	3 x 1s with 120 A

Rated data acc. to CSA

Institute (CSA)	CSA	Certificate No. (CSA)	200039-1121690
Rated voltage (Use group B / CSA)	300 V	Rated voltage (Use group D / CSA)	300 V
Rated current (Use group B / CSA)	15 A	Rated current (Use group D / CSA)	10 A
Reference to approval values	Specifications are maximum values, details - see approval certificate.		

Rated data acc. to UL 1059

Institute (UR)	UR	Certificate No. (UR)	E60693
Rated voltage (Use group B / UL 1059)	300 V	Rated voltage (Use group D / UL 1059)	300 V
Rated current (Use group B / UL 1059)	15 A	Rated current (Use group D / UL 1059)	10 A
Reference to approval values	Specifications are maximum values, details - see approval certificate.		

Packing

Packaging	Box	VPE length	349.00 mm
VPE width	136.00 mm	VPE height	30.00 mm

Important note

IPC conformity
Conformity: The products are developed, manufactured and delivered according international recognized standards and norms and comply with the assured properties in the data sheet resp. fulfill decorative properties in accordance with IPC-A-610 "Class 2". Further claims on the products can be evaluated on request.

- Notes
- Additional variants on request
 - Gold-plated contact surfaces on request
 - Rated current related to rated cross-section & min. No. of poles.
 - P on drawing = pitch
 - Rated data refer only to the component itself. Clearance and creepage distances to other components are to be designed in accordance with the relevant application standards.
 - In accordance with IEC 61984, OMNIMATE-connectors are connectors without breaking capacity (COC). During designated use, connectors are not allowed to be engaged or disengaged when live or under load
 - Long term storage of the product with average temperature of 50 °C and maximum humidity 70%, 36 months

Classifications

ETIM 8.0	EC002637	ETIM 9.0	EC002637
ETIM 10.0	EC002637	ECLASS 14.0	27-46-02-01
ECLASS 15.0	27-46-02-01		

Product image

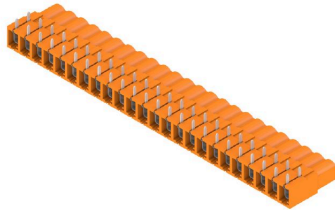

Dimensional drawing

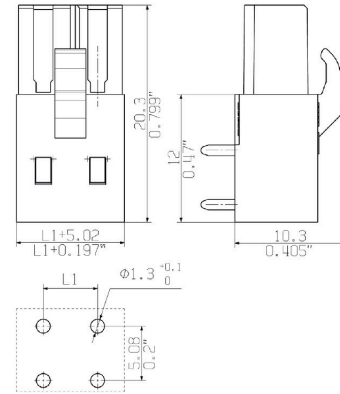

Example of use

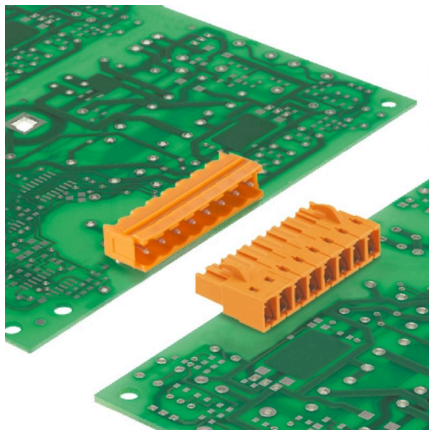

Accessories

Coding elements



Only connects what is supposed to be connected: the right connection at the right place.
 Coding elements and locking devices clearly assign connecting elements during the manufacturing process and operation
 The coding elements and locking devices are inserted prior to assembly or during the cable assembly phase. The Weidmüller alternative: configure online using the variant configurator to precode prior to delivery. Incorrect assembly on the circuit board and incorrect plugging of connecting elements is no longer possible. The advantage: no troubleshooting during manufacture and no operational errors by the user.

General ordering data

Type	BLZ/SL KO BK BX	Version
Order No.	1545710000	PCB plug-in connector, Accessories, Coding element, black, Number
GTIN (EAN)	4008190087142	of poles: 1
Qty.	50 ST	
Type	BLZ/SL KO OR BX	Version
Order No.	1573010000	PCB plug-in connector, Accessories, Coding element, orange, Number
GTIN (EAN)	4008190048396	of poles: 1
Qty.	100 ST	

BLL 5.08/24/90 3.2 SN OR BX

Weidmüller Interface GmbH & Co. KG
Klingenbergstraße 26
D-32758 Detmold
Germany

www.weidmueller.com

Counterpart

SL 5.08/135



Male connectors with 135° outlet direction. The solder pin length is optimised for wave flow soldering. The pin headers provide space for labelling and can be coded.

General ordering data

Type	SL 5.08/24/135 3.2SN OR...	Version
Order No.	1603280000	PCB plug-in connector, male header, open side, THT solder
GTIN (EAN)	4008190118914	connection, 5.08 mm, Number of poles: 24, 135°, Solder pin length
Qty.	20 ST	(l): 3.2 mm, tinned, orange, Box

SL 5.08/135B



Male connectors with 135° outlet direction. The solder pin length is optimised for wave flow soldering. The pin headers provide space for labelling and can be coded.

General ordering data

Type	SL 5.08/24/135B 3.2SN O...	Version
Order No.	1605750000	PCB plug-in connector, male header, Dovetails for fixing blocks, THT
GTIN (EAN)	4008190007683	solder connection, 5.08 mm, Number of poles: 24, 135°, Solder pin
Qty.	20 ST	length (l): 3.2 mm, tinned, orange, Box

SL 5.08/180



Male connectors with straight outlet direction. The solder pin length is optimised for wave flow soldering. The pin headers provide space for labelling and can be coded.

General ordering data

Type	SL 5.08/24/180 3.2SN OR...	Version
Order No.	1519460000	PCB plug-in connector, male header, open side, THT solder
GTIN (EAN)	4008190140540	connection, 5.08 mm, Number of poles: 24, 180°, Solder pin length
Qty.	20 ST	(l): 3.2 mm, tinned, orange, Box

BLL 5.08/24/90 3.2 SN OR BX

Weidmüller Interface GmbH & Co. KG
 Klingenbergstraße 26
 D-32758 Detmold
 Germany

www.weidmueller.com

Counterpart

SL 5.08/180B



Male connectors with straight outlet direction. The solder pin length is optimised for wave flow soldering. The pin headers provide space for labelling and can be coded.

General ordering data

Type	SL 5.08/24/180B 3.2SN O...	Version
Order No.	1521760000	PCB plug-in connector, male header, Dovetails for fixing blocks, THT
GTIN (EAN)	4008190122027	solder connection, 5.08 mm, Number of poles: 24, 180°, Solder pin
Qty.	20 ST	length (l): 3.2 mm, tinned, orange, Box

SL 5.08/90



Male connectors with 90° outlet direction. The solder pin length is optimised for wave flow soldering. The pin headers provide space for labelling and can be coded.

General ordering data

Type	SL 5.08/24/90 3.2SN OR ...	Version
Order No.	1510260000	PCB plug-in connector, male header, open side, THT solder
GTIN (EAN)	4008190078362	connection, 5.08 mm, Number of poles: 24, 90°, Solder pin length (l):
Qty.	20 ST	3.2 mm, tinned, orange, Box

SL 5.08/90B

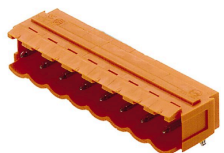

Male connectors with 90° outlet direction. The solder pin length is optimised for wave flow soldering. The pin headers provide space for labelling and can be coded.

General ordering data

Type	SL 5.08/24/90B 3.2SN OR...	Version
Order No.	1512560000	PCB plug-in connector, male header, Dovetails for fixing blocks, THT
GTIN (EAN)	4008190052560	solder connection, 5.08 mm, Number of poles: 24, 90°, Solder pin
Qty.	20 ST	length (l): 3.2 mm, tinned, orange, Box

BLL 5.08/24/90 3.2 SN OR BX

Weidmüller Interface GmbH & Co. KG
 Klingenbergstraße 26
 D-32758 Detmold
 Germany

www.weidmueller.com

Counterpart

SL 5.08HC/180

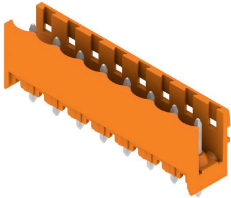

Pin headers in glass-fibre-reinforced plastic with straight wire outlet; optimised for wave soldering. The flange variant (F) can be screwed onto the respective counter piece or the circuit board. There is no need for an extra screw to connect the circuit board when the solder flange (LF) version is used. This also protects the solder points from mechanical strain. All pin headers can be manually coded or ordered pre-coded. HC = High Current.

General ordering data

Type	SL 5.08HC/24/180 3.2SN ...	Version
Order No.	1148600000	PCB plug-in connector, male header, open side, THT solder connection, 5.08 mm, Number of poles: 24, 180°, Solder pin length (l): 3.2 mm, tinned, black, Box
GTIN (EAN)	4032248934522	
Qty.	20 ST	

Type	SL 5.08HC/24/180 3.2SN ...	Version
Order No.	1146710000	PCB plug-in connector, male header, open side, THT solder connection, 5.08 mm, Number of poles: 24, 180°, Solder pin length (l): 3.2 mm, tinned, orange, Box
GTIN (EAN)	4032248108695	
Qty.	20 ST	

SL 5.08HC/180B

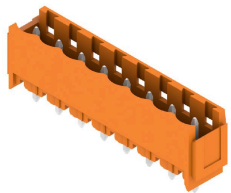

Pin headers in glass-fibre-reinforced plastic with straight wire outlet; optimised for wave soldering. The flange variant (F) can be screwed onto the respective counter piece or the circuit board. There is no need for an extra screw to connect the circuit board when the solder flange (LF) version is used. This also protects the solder points from mechanical strain. All pin headers can be manually coded or ordered pre-coded. HC = High Current.

General ordering data

Type	SL 5.08HC/24/180B 3.2SN...	Version
Order No.	1150080000	PCB plug-in connector, male header, Dovetails for fixing blocks, THT solder connection, 5.08 mm, Number of poles: 24, 180°, Solder pin length (l): 3.2 mm, tinned, black, Box
GTIN (EAN)	4032248935222	
Qty.	20 ST	

Type	SL 5.08HC/24/180B 3.2SN...	Version
Order No.	1148040000	PCB plug-in connector, male header, Dovetails for fixing blocks, THT solder connection, 5.08 mm, Number of poles: 24, 180°, Solder pin length (l): 3.2 mm, tinned, orange, Box
GTIN (EAN)	4032248934959	
Qty.	20 ST	

BLL 5.08/24/90 3.2 SN OR BX

Weidmüller Interface GmbH & Co. KG
Klingenbergstraße 26
D-32758 Detmold
Germany

Counterpart

www.weidmueller.com

SL 5.08HC/180G

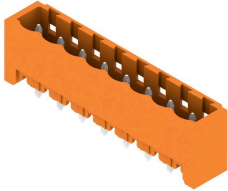

Pin headers in glass-fibre-reinforced plastic with straight wire outlet; optimised for wave soldering. The flange variant (F) can be screwed onto the respective counter piece or the circuit board. There is no need for an extra screw to connect the circuit board when the solder flange (LF) version is used. This also protects the solder points from mechanical strain. All pin headers can be manually coded or ordered pre-coded. HC = High Current.

General ordering data

Type	SL 5.08HC/24/180G 3.2SN...	Version
Order No.	1149370000	PCB plug-in connector, male header, closed side, THT solder
GTIN (EAN)	4032248934621	connection, 5.08 mm, Number of poles: 24, 180°, Solder pin length
Qty.	20 ST	(I): 3.2 mm, tinned, black, Box
Type	SL 5.08HC/24/180G 3.2SN...	Version
Order No.	1147270000	PCB plug-in connector, male header, closed side, THT solder
GTIN (EAN)	4032248934164	connection, 5.08 mm, Number of poles: 24, 180°, Solder pin length
Qty.	20 ST	(I): 3.2 mm, tinned, orange, Box

SL 5.08HC/90

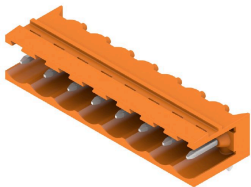

Pin headers made from glass-fibre-reinforced plastic with 90° wire outlet; optimised for wave soldering. The flange variant (F) can be screwed onto the respective counter piece or the circuit board. There is no need for an extra screw to connect the circuit board when the solder flange (LF) version is used. This also protects the solder points from mechanical strain. All pin headers can be manually coded or ordered pre-coded. HC = High Current.

General ordering data

Type	SL 5.08HC/24/90 3.2SN B...	Version
Order No.	1155310000	PCB plug-in connector, male header, open side, THT solder
GTIN (EAN)	4050118050592	connection, 5.08 mm, Number of poles: 24, 90°, Solder pin length (I):
Qty.	20 ST	3.2 mm, tinned, black, Box
Type	SL 5.08HC/24/90 3.2SN O...	Version
Order No.	1147250000	PCB plug-in connector, male header, open side, THT solder
GTIN (EAN)	4050118051285	connection, 5.08 mm, Number of poles: 24, 90°, Solder pin length (I):
Qty.	20 ST	3.2 mm, tinned, orange, Box

BLL 5.08/24/90 3.2 SN OR BX

Weidmüller Interface GmbH & Co. KG
 Klingenbergstraße 26
 D-32758 Detmold
 Germany

Counterpart

www.weidmueller.com

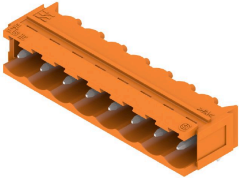
SL 5.08HC/90B

Pin headers made from glass-fibre-reinforced plastic with 90° wire outlet; optimised for wave soldering. The flange variant (F) can be screwed onto the respective counter piece or the circuit board. There is no need for an extra screw to connect the circuit board when the solder flange (LF) version is used. This also protects the solder points from mechanical strain. All pin headers can be manually coded or ordered pre-coded. HC = High Current.

General ordering data

Type	SL 5.08HC/24/90B 3.2SN ...	Version
Order No.	1155820000	PCB plug-in connector, male header, Dovetails for fixing blocks, THT
GTIN (EAN)	4050118049930	solder connection, 5.08 mm, Number of poles: 24, 90°, Solder pin
Qty.	20 ST	length (l): 3.2 mm, tinned, black, Box
Type	SL 5.08HC/24/90B 3.2SN ...	Version
Order No.	1155020000	PCB plug-in connector, male header, Dovetails for fixing blocks, THT
GTIN (EAN)	4050118050820	solder connection, 5.08 mm, Number of poles: 24, 90°, Solder pin
Qty.	20 ST	length (l): 3.2 mm, tinned, orange, Box

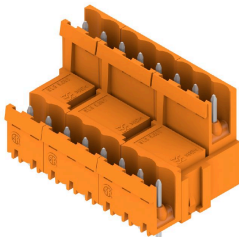
SLDV 5.08/180

Pin headers with solder pin length optimised for wave flow soldering. The male connectors provide space for labelling and can be coded. HC = High Current.

General ordering data

Type	SLD 5.08V/48/180 3.2SN ...	Version
Order No.	1725870000	PCB plug-in connector, male header, open side, THT solder
GTIN (EAN)	4032248062164	connection, 5.08 mm, Number of poles: 48, 180°, Solder pin length
Qty.	10 ST	(l): 3.2 mm, tinned, orange, Box

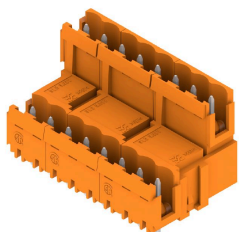
SLDV 5.08/180B

Pin headers with solder pin length optimised for wave flow soldering. The male connectors provide space for labelling and can be coded. HC = High Current.

BLL 5.08/24/90 3.2 SN OR BX

Weidmüller Interface GmbH & Co. KG
 Klingenbergstraße 26
 D-32758 Detmold
 Germany

Counterpart

www.weidmueller.com

General ordering data

Type	SLD 5.08V/48/180B 3.2SN...	Version
Order No.	1726960000	PCB plug-in connector, male header, Dovetails for fixing blocks, THT
GTIN (EAN)	4032248062850	solder connection, 5.08 mm, Number of poles: 48, 180°, Solder pin
Qty.	10 ST	length (l): 3.2 mm, tinned, orange, Box

SLDV 5.08/90

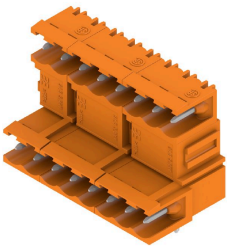

Pin headers with solder pin length optimised for wave flow soldering. The male connectors provide space for labelling and can be coded. HC = High Current.

General ordering data

Type	SLD 5.08V/48/90 3.2 SN ...	Version
Order No.	1725390000	PCB plug-in connector, male header, open side, THT solder
GTIN (EAN)	4032248060795	connection, 5.08 mm, Number of poles: 48, 90°, Solder pin length (l):
Qty.	10 ST	3.2 mm, tinned, orange, Box

SLDV 5.08/90B

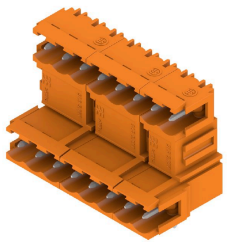

Pin headers with solder pin length optimised for wave flow soldering. The male connectors provide space for labelling and can be coded. HC = High Current.

General ordering data

Type	SLD 5.08V/48/90B 3.2 SN...	Version
Order No.	1726500000	PCB plug-in connector, male header, Dovetails for fixing blocks, THT
GTIN (EAN)	4032248061471	solder connection, 5.08 mm, Number of poles: 48, 90°, Solder pin
Qty.	10 ST	length (l): 3.2 mm, tinned, orange, Box

BLL 5.08/24/90 3.2 SN OR BX

Weidmüller Interface GmbH & Co. KG
 Klingenbergstraße 26
 D-32758 Detmold
 Germany

www.weidmueller.com

Counterpart

SL-SMT 5.08/180 Box

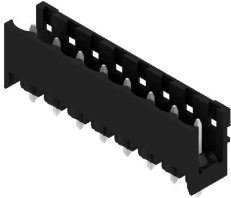

High-temperature-resistant, straight, open pin header. Packed in box or tape. On tape and with 1.5 mm solder pin, optimised for automatic assembly. 3.2 mm solder pin suitable for reflow and wave soldering. The pin headers provide space for labelling and can be coded. HC = High Current.

General ordering data

Type	SL-SMT 5.08HC/24/180 3...	Version
Order No.	1838200000	PCB plug-in connector, male header, open side, THT/THR solder connection, 5.08 mm, Number of poles: 24, 180°, Solder pin length (l): 3.2 mm, tinned, black, Box
GTIN (EAN)	4032248348268	
Qty.	20 ST	

SL-SMT 5.08/180G Box

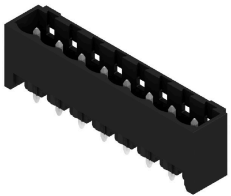

High-temperature-resistant pin header, packed in box or tape. On tape, with 1.5 mm solder pin, optimised for automatic assembly. 3.2 mm solder pin suitable for reflow and wave soldering. The pin headers provide space for labelling and can be coded. HC = High Current.

General ordering data

Type	SL-SMT 5.08HC/24/180G 3...	Version
Order No.	1838430000	PCB plug-in connector, male header, closed side, THT/THR solder connection, 5.08 mm, Number of poles: 24, 180°, Solder pin length (l): 3.2 mm, tinned, black, Box
GTIN (EAN)	4032248348497	
Qty.	20 ST	

SL-SMT 5.08HC/90 Box



High-temperature-resistant, 90° angled, open male header. Packed in box or tape. On tape, with 1.5 mm solder pin, optimised for automatic assembly. 3.2 mm solder pin suitable for reflow and wave soldering. The pin headers provide space for labelling and can be coded. HC = High Current.

General ordering data

Type	SL-SMT 5.08HC/24/90 1.5...	Version
Order No.	1774982001	PCB plug-in connector, male header, open side, THT/THR solder connection, 5.08 mm, Number of poles: 24, 90°, Solder pin length (l): 1.5 mm, tinned, black, Box
GTIN (EAN)	4032248156016	
Qty.	20 ST	

BLL 5.08/24/90 3.2 SN OR BX

Weidmüller Interface GmbH & Co. KG
Klingenbergstraße 26
D-32758 Detmold
Germany

www.weidmueller.com

Counterpart

Type	SL-SMT 5.08HC/24/90 3.2...	Version
Order No.	1780170000	PCB plug-in connector, male header, open side, THT/THR solder
GTIN (EAN)	4032248165490	connection, 5.08 mm, Number of poles: 24, 90°, Solder pin length (l):
Qty.	20 ST	3.2 mm, tinned, black, Box

SL-SMT 5.08HC/90G Box



High-temperature-resistant pin header, packed in box or tape. On tape, with 1.5 mm solder pin, optimised for automatic assembly. 3.2 mm solder pin suitable for reflow and wave soldering. The pin headers provide space for labelling and can be coded. HC = High Current.

General ordering data

Type	SL-SMT 5.08HC/24/90G 3....	Version
Order No.	1780400000	PCB plug-in connector, male header, closed side, THT/THR solder
GTIN (EAN)	4032248165728	connection, 5.08 mm, Number of poles: 24, 90°, Solder pin length (l):
Qty.	20 ST	3.2 mm, tinned, black, Box

SLS 5.08/180B

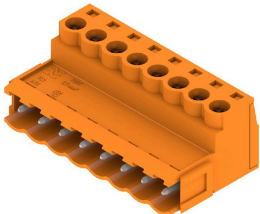

Male plugs with clamping-yoke screw wire-connect system. The male plugs provide space for labelling and can be coded.

General ordering data

Type	SLS 5.08/24/180B SN OR ...	Version
Order No.	1645220000	PCB plug-in connector, male plug, 5.08 mm, Number of poles: 24,
GTIN (EAN)	4008190284435	180°, Clamping yoke connection, Clamping range, max. : 3.31 mm ² ,
Qty.	12 ST	Box

BLL 5.08/24/90 3.2 SN OR BX

Weidmüller Interface GmbH & Co. KG
 Klingenbergstraße 26
 D-32758 Detmold
 Germany

Counterpart

www.weidmueller.com

SLS 5.08TB KF35

Male plugs with clamping-yoke screw wire-connect system. With clip-on feet for attaching the male plugs on rail. The male plugs provide space for labelling and can be coded.

General ordering data

Type	SLS 5.08/24/180TB KF SN...	Version
Order No.	1846200000	PCB plug-in connector, male plug, 5.08 mm, Number of poles: 24,
GTIN (EAN)	4032248362486	180°, Clamping yoke connection, Clamping range, max. : 3.31 mm²,
Qty.	5 ST	Box

SLS 5.08TB RF15

Male plugs with clamping-yoke screw wire-connect system. With clip-on feet for attaching the male plugs on rail. The male plugs provide space for labelling and can be coded.

General ordering data

Type	SLS 5.08/24/180TB RF15 ...	Version
Order No.	1846120000	PCB plug-in connector, male plug, 5.08 mm, Number of poles: 24,
GTIN (EAN)	4032248362400	180°, Clamping yoke connection, Clamping range, max. : 3.31 mm²,
Qty.	5 ST	Box