

# SPDE



## Single Phase Compact Power Supply



### Benefits

- **Compact dimensions:** SPDE can save up to 50% panel-width space thanks to its ultra-slim design. The 480 W model is just 48 mm wide.
- **High efficiency:** The built-in PFC (on SPDE..R models) results in high operating efficiency up to 94%.
- **Flexible installation:** Universal AC/DC input range with AC voltage (90 VAC to 264 VAC) or with DC voltage (120 VDC to 370 VDC).
- **Integrated protection:** Output short circuit, over-current, over-voltage, over-temperature protection.
- **Wide operating temperature:** SPDE..R models can work in extreme temperatures from -40°C to +70°C (-40°F to +158°F).

### Description

The SPDE series of DIN-rail mount power supplies encompasses high performance within an extremely compact footprint. Power ratings start from 75 W up to 480 W with 12, 24 and 48 VDC output. The SPDE achieves high operating efficiency of up to 94% @ 230 VAC. Features such as DC ok output relay (for SPDE..R models) and built-in protection functions ensure a high degree of reliability during operation.

All specifications are at nominal values, full load, 25°C unless otherwise stated.

### Applications

Installations with limited panel space, industrial equipment, machinery.

### Main functions

- Output short circuit, over-current, over-voltage and over-temperature protection
- DC OK relay indication (only in SPDE..R models)
- Built-in active PFC (only in SPDE..R models)

## References

### Order code



SPDE   1



Enter the code entering the corresponding option instead of .

| Code                     | Option | Description        | Notes                |
|--------------------------|--------|--------------------|----------------------|
| S                        | -      | Switching          | Device typology      |
| P                        | -      | Power              |                      |
| D                        | -      | DIN rail           |                      |
| E                        | -      | High efficiency    | Mounting             |
| <input type="checkbox"/> | 12     | 12 VDC             |                      |
|                          | 24     | 24 VDC             | Rated output voltage |
|                          | 48     | 48 VDC             |                      |
| <input type="checkbox"/> | 75     | 75 W               | Rated output power   |
|                          | 120    | 120 W              |                      |
|                          | 190    | 192 W              |                      |
|                          | 240    | 240 W              |                      |
|                          | 480    | 480 W              |                      |
| 1                        | -      | Single phase input | Input type           |
| <input type="checkbox"/> | -      | -                  |                      |
|                          | R      | Relay output       |                      |

### Selection guide

| Output Voltage | SPDE..75  | SPDE..120                 | SPDE..190   | SPDE..240                 | SPDE..480   |
|----------------|-----------|---------------------------|-------------|---------------------------|-------------|
| 12 VDC         | SPDE12751 | SPDE121201R               | SPDE121901R | -                         | -           |
| 24 VDC         | SPDE24751 | SPDE241201<br>SPDE241201R | -           | SPDE242401<br>SPDE242401R | SPDE244801R |
| 48 VDC         | SPDE48751 | SPDE481201R               | -           | SPDE482401R               | SPDE484801R |

### Further reading

| Information             | Where to find it  | QR code   |
|-------------------------|---|---|
| SPDE datasheet          | <a href="https://gavazziautomation.com/images/PIM/DATASHEET/ENG/SPDE_DS_EN.pdf">https://gavazziautomation.com/images/PIM/DATASHEET/ENG/SPDE_DS_EN.pdf</a> |  |
| SPDE installation sheet | <a href="https://gavazziautomation.com/images/PIM/MANUALS/ENG/SPDE_IM.pdf">https://gavazziautomation.com/images/PIM/MANUALS/ENG/SPDE_IM.pdf</a>           |  |

# Structure

SPDE..75 / SPDE..120 / SPDE..190 / SPDE..240

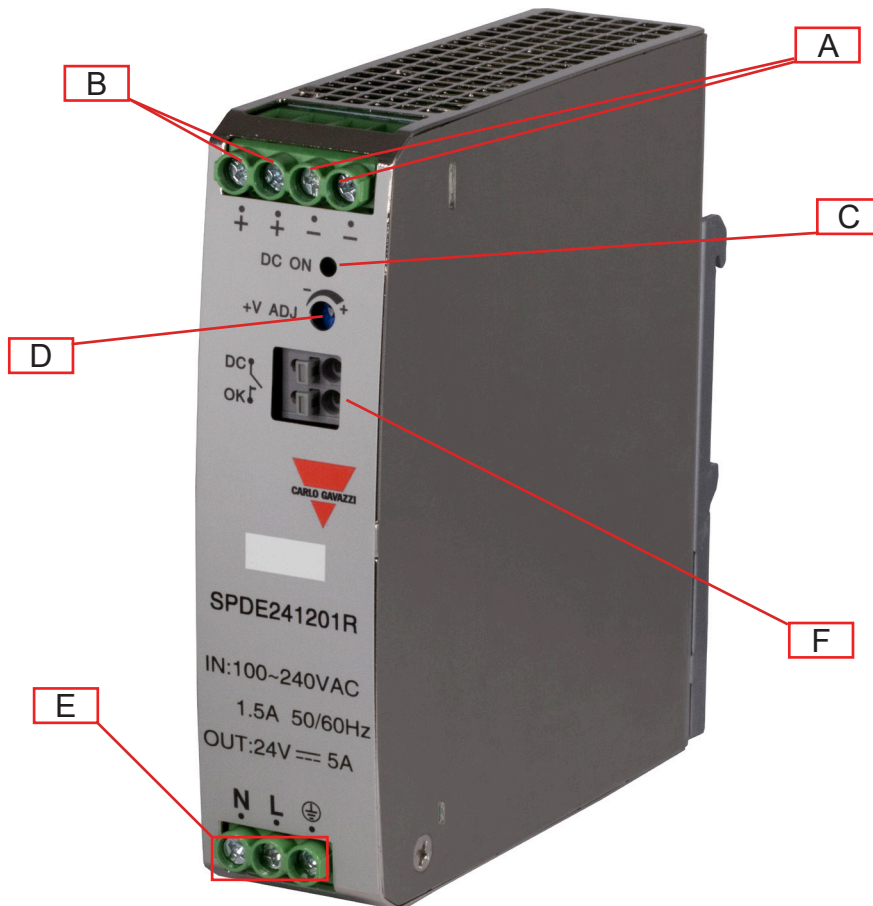

| Element | Component       | Function  |
|---------|-----------------|---|
| A       | - V terminals   | Negative DC Output terminals  |
| B       | + V terminals   | Positive DC Output terminals  |
| C       | DC OK LED       | Green when output voltage is active   |
| D       | VADJ trimmer    | Output voltage adjustment   |
| E       | Input terminals | L, N supply terminals and Protective Earth (PE)   |
| F       | DC OK relay*    | Relay rating: 30 VDC / 1 A max. (resistive load)<br>Relay contacts closed when output voltage $\geq$ 90% of rated output voltage. |

\* applies to SPDE..R models only

**SPDE..480..R**

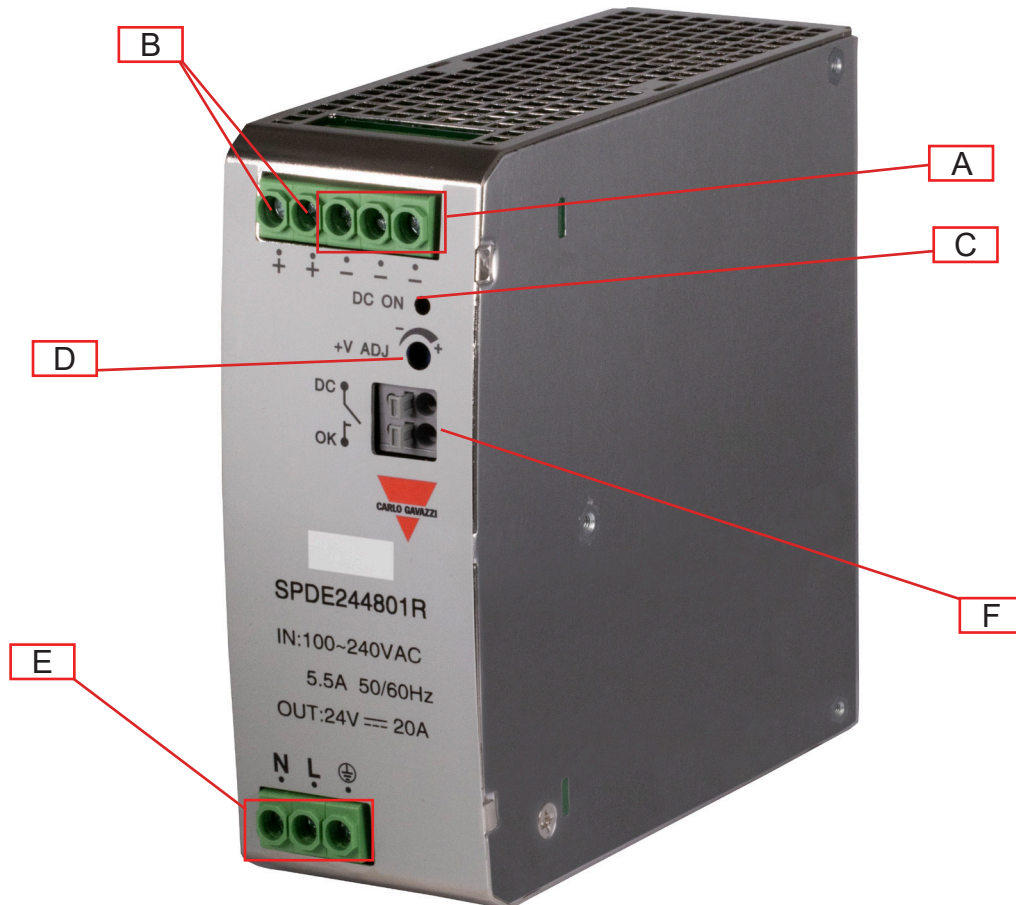

| Element | Component       | Function  |
|---------|-----------------|---|
| A       | - V terminals   | Negative DC Output terminals  |
| B       | + V terminals   | Positive DC Output terminals  |
| C       | DC OK LED       | Green when output voltage is active   |
| D       | VADJ trimmer    | Output voltage adjustment   |
| E       | Input terminals | L, N supply terminals and Protective Earth (PE)   |
| F       | DC OK relay     | Relay rating: 30 VDC / 1 A max. (resistive load)<br>Relay contacts closed when output voltage $\geq$ 90% of rated output voltage. |

# Features

## General data

|                                   | SPDE..75                                     | SPDE..120  | SPDE..190    | SPDE..240                    | SPDE..480                    |
|-----------------------------------|--|--|--------------|------------------------------|------------------------------|
| Leakage current (input-output)    | <0.5 mA                                      | <1.0 mA  | <0.5 mA      |                              | <0.8 mA                      |
| Earth leakage current (input-GND) |  | -  | <1.0 mA      |                              | -                            |
| Efficiency                        | 86% (12 VDC)<br>89% (24 VDC)<br>90% (48 VDC) | 88%*<br>93.5% (12 VDC)<br>94% (24 VDC)<br>94% (48 VDC) | 92% (12 VDC) | 94% (24 VDC)<br>94% (48 VDC) | 94% (24 VDC)<br>94% (48 VDC) |
| Power loss @ nominal load         | ≤1.5W  | -  |              |                              |                              |
| Power factor (full load)          |  |  |              |                              |                              |
| 115 VAC                           | -  | 0.98   |              | 0.98                         | 0.99                         |
| 230 VAC                           |  | 0.94   |              | 0.94 / 0.95*                 | 0.99                         |
| Ingress protection                | IP20   |  |              |                              |                              |
| MTBF (MIL-HDBK-217F)              | >300,000 h                                   |  |              |                              |                              |
| Case material                     | Metal  |  |              |                              |                              |
| Weight                            | 350 g  | 410 g*<br>490 g ± 10%                                  | 600 g        | 600 g**<br>650 g             | 980 g                        |

\* applies to SPDE241201 only

\*\* applies to SPDE242401 only

## Dimensions

### SPDE..75

Unit: mm [inch]

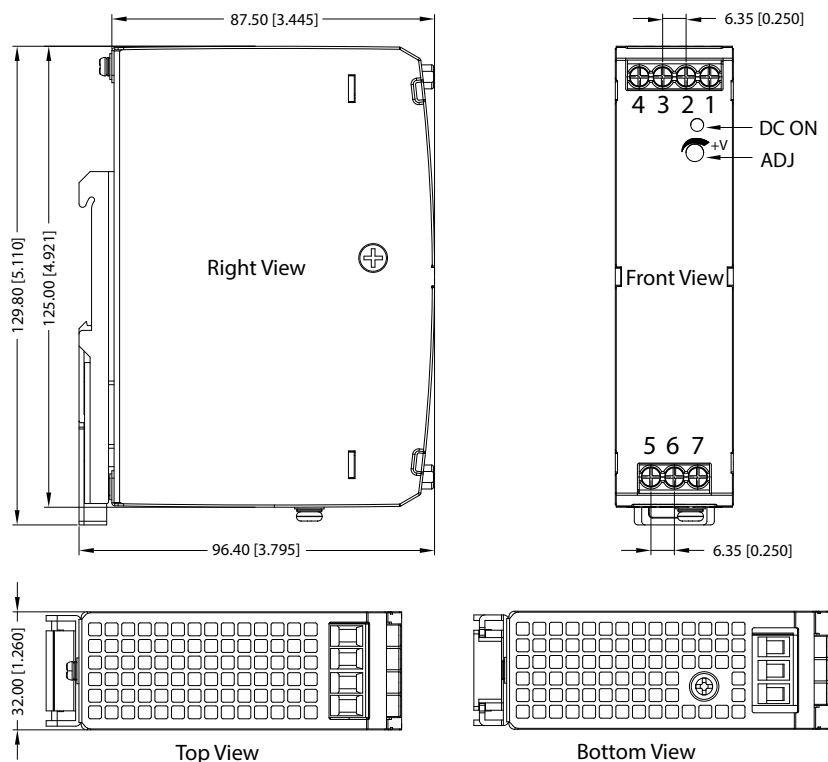

**SPDE..120**  
Unit: mm [inch]

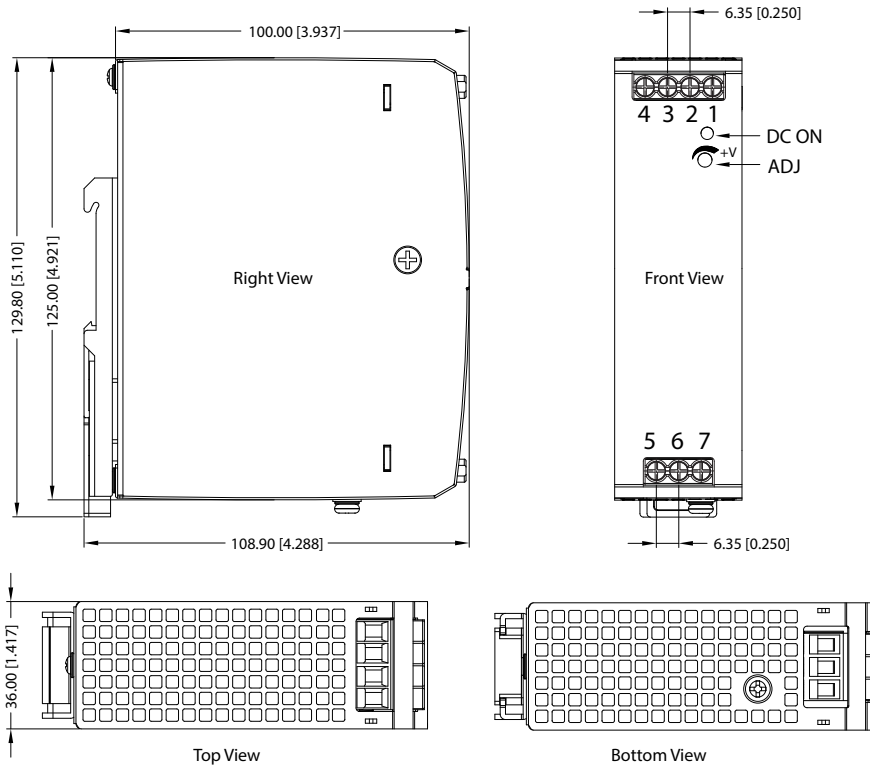

**SPDE..120..R**  
Unit: mm [inch]

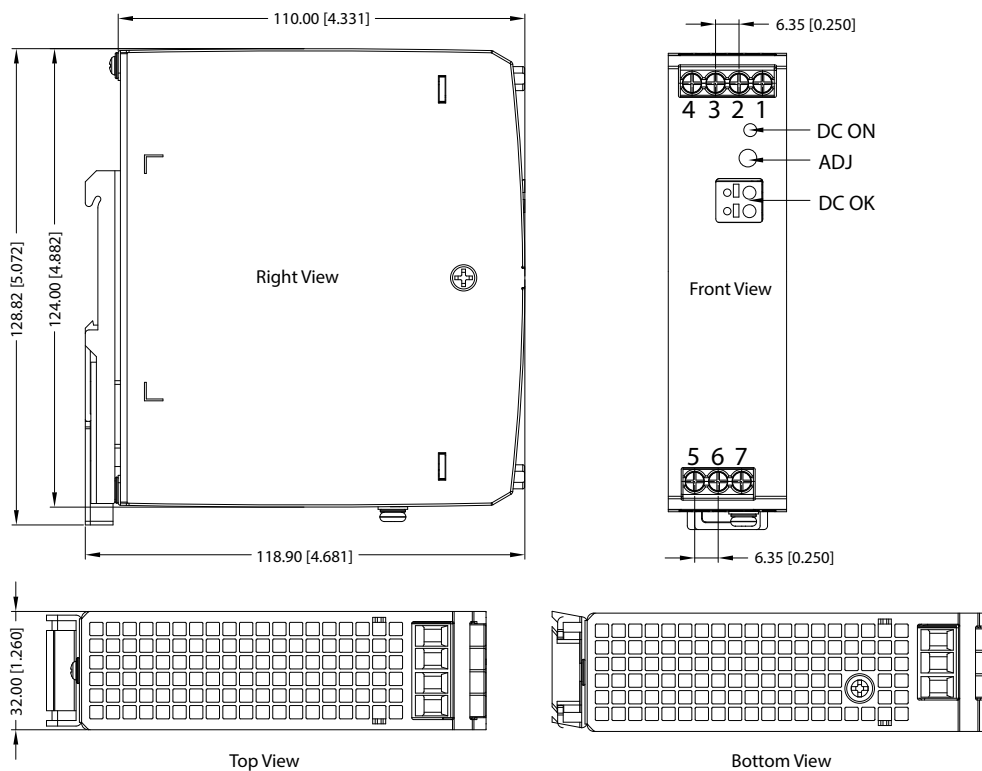

**SPDE242401**  
Unit: mm [inch]

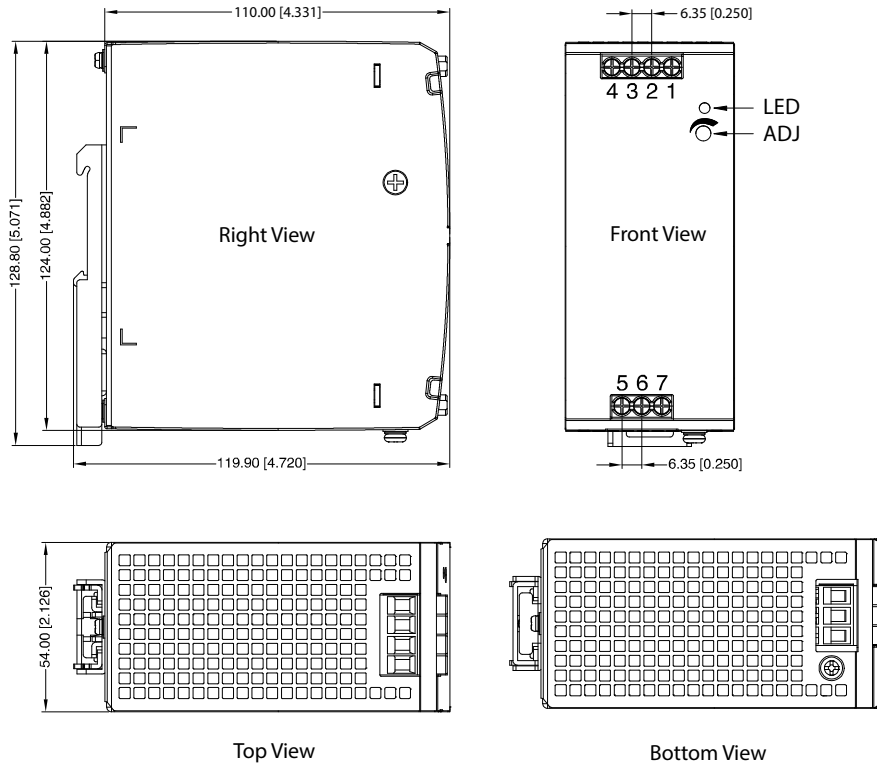

**SPDE..190..R / SPDE..240..R**  
Unit: mm [inch]

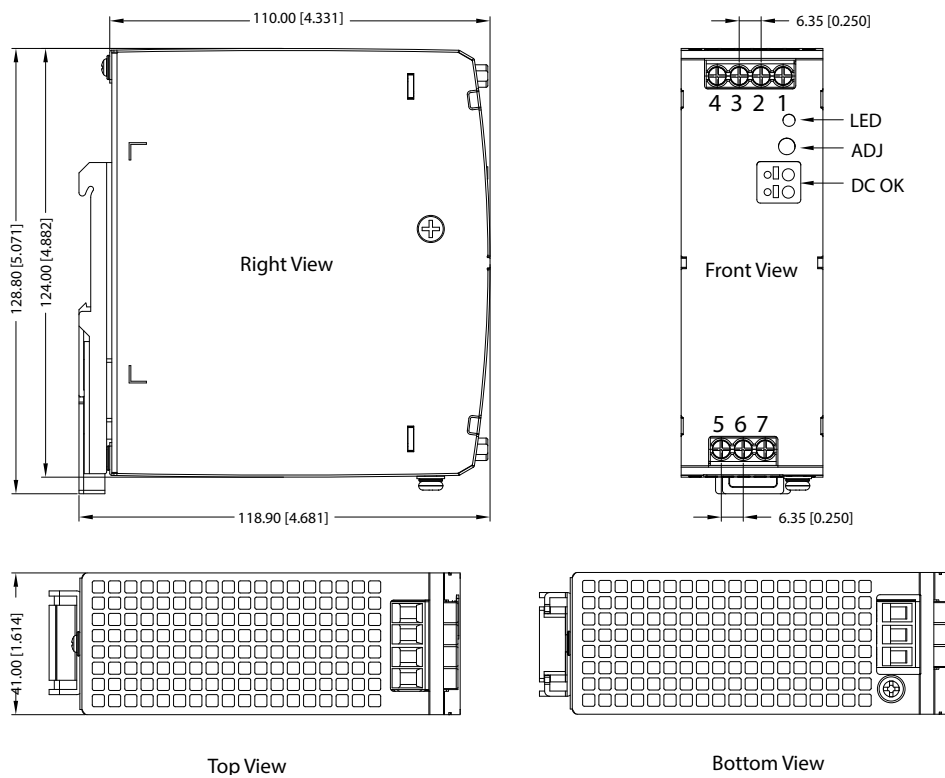

**SPDE..480..R**  
 Unit: mm [inch]

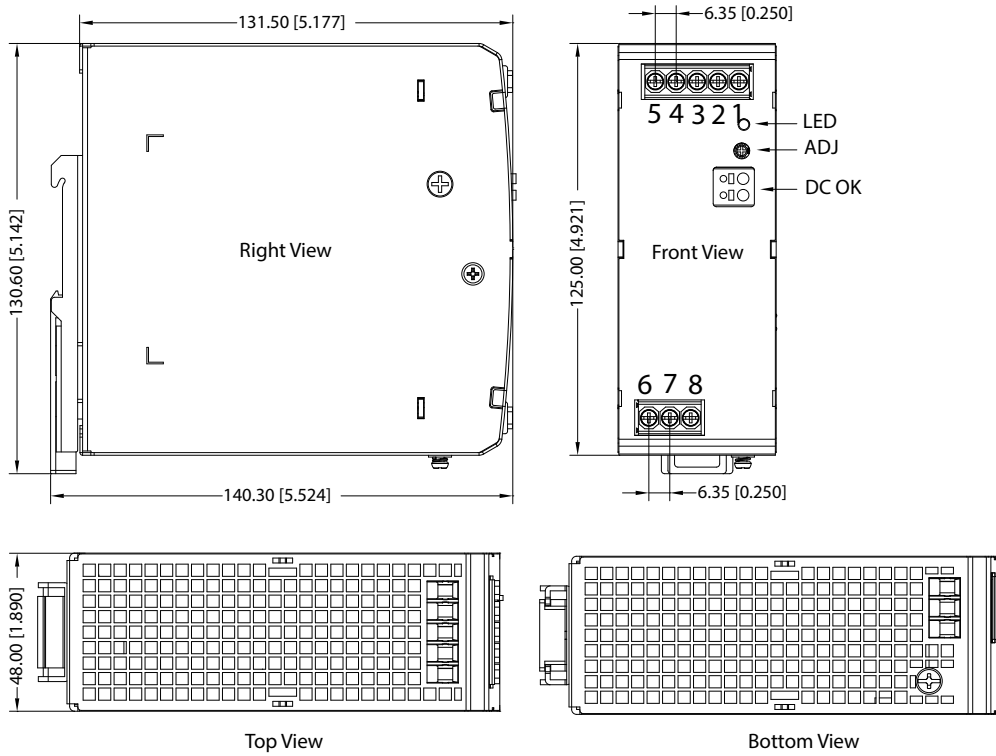

# Connection diagram

## Terminal markings

### SPDE..75 / SPDE..120 / SPDE..190 / SPDE..240

| Terminal | Designation     | Description  |
|----------|-----------------|--|
| 1        | -V <sub>o</sub> | Negative output terminal                                       |
| 2        | -V <sub>o</sub> | Negative output terminal                                       |
| 3        | +V <sub>o</sub> | Positive output terminal                                       |
| 4        | +V <sub>o</sub> | Positive output terminal                                       |
| 5        | AC(N)           | Input terminals (neutral conductor, no polarity with DC input) |
| 6        | AC(L)           | Input terminals (phase conductor, no polarity with DC input)   |
| 7        | PE              | Ground this terminal to minimize high frequency emissions      |

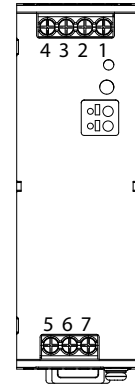

### SPDE..480

| Terminal | Designation     | Description  |
|----------|-----------------|--|
| 1        | -V <sub>o</sub> | Negative output terminal                                       |
| 2        | -V <sub>o</sub> | Negative output terminal                                       |
| 3        | -V <sub>o</sub> | Negative output terminal                                       |
| 4        | +V <sub>o</sub> | Positive output terminal                                       |
| 5        | +V <sub>o</sub> | Positive output terminal                                       |
| 6        | AC(N)           | Input terminals (neutral conductor, no polarity with DC input) |
| 7        | AC(L)           | Input terminals (phase conductor, no polarity with DC input)   |
| 8        | PE              | Ground this terminal to minimize high frequency emissions      |

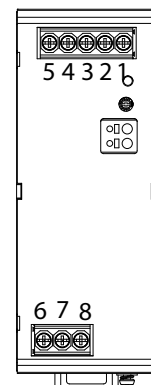

## Environmental

|                       | SPDE..75                        | SPDE..120   | SPDE..190                       | SPDE..240 | SPDE..480                       |
|-----------------------|---------------------------------|---|---------------------------------|-----------|---------------------------------|
| Operating temperature | -30°C to 70°C<br>-22°F to 158°F | -20°C to 60°C*<br>-4°F to 140°F*<br>-40°C to 70°C<br>-40°F to 158°F | -40°C to 70°C<br>-40°F to 158°F |           | -30°C to 70°C<br>-22°F to 158°F |
| Storage temperature   | -40°C to 85°C<br>-40°F to 185°F |   |                                 |           |                                 |
| Humidity              | <95% RH Non-condensing          |   |                                 |           |                                 |
| Temperature derating  | Refer to derating diagram       |   |                                 |           |                                 |

\* applies to SPDE241201 only



**Compatibility and conformity**

|   | SPDE..75   | SPDE..120   | SPDE..190                               | SPDE..240 | SPDE..480               |
|---|--|---|---|-----------|-------------------------|
| <b>Safety standards</b>   | UL/EN62368-1<br>UL61010-1  | EN62368-1 <sup>1</sup><br>UL61010-1 <sup>1</sup><br>UL61010-2-201 | EN62368-1<br>UL61010-1<br>UL61010-2-201 |           | EN62368-1<br>UL61010-1  |
| <b>Approvals</b>  |  |   |   |           |                         |
| <b>Conducted (CS)</b><br>IEC/EN 61000-4-6                         | 10 Vrms (PC A)   |   |   |           |                         |
| <b>Voltage dips and interruptions</b><br>IEC/EN61000-4-11         | 0% (PC B)<br>70% (PC B)  |   |   |           | 0% (PC A)<br>70% (PC A) |
| <b>EMC emission</b><br>CE: CISPR32/EN55032<br>RE: CISPR32/EN55032 | CLASS B<br>CLASS B   | CLASS A<br>CLASS A  | CLASS B<br>CLASS B                      |           |                         |
| <b>Harmonic current</b>   | IEC/EN61000-3-2 CLASS A  |   | IEC/EN61000-3-2 CLASS A and CLASS D     |           |                         |
| <b>EMC immunity</b>   | EN61000-4-2, EN61000-4-3, EN61000-4-4, EN61000-4-5,<br>EN61000-4-6, EN61000-4-11 |   |   |           |                         |
| <b>Vibration resistance</b>                                       | 10 ~ 500 Hz, 2G, 10 min. / 1 cycle, period for 60 min. Each along X, Y, Z axes.  |   |   |           |                         |
| <b>Semi F47</b>   | Tolerated sags to 50% of equipment nominal voltage for duration of up to 200 ms  |   |   |           |                         |

- 1. applies to SPDE241201 only
- 2. applies to SPDE..75 only

**Insulation**

|  | SPDE..75           | SPDE..120                                 | SPDE..190          | SPDE..240 | SPDE..480          |
|--|--------------------|---|--------------------|-----------|--------------------|
| <b>Insulation / withstand voltage (input / GND)</b>    | 2.0 kVAC / < 10 mA | 2.0 kVAC / < 10 mA*<br>1.5 kVAC / < 15 mA | 2.0 kVAC / < 15 mA |           | 2.0 kVAC / < 10 mA |
| <b>Insulation / withstand voltage (input / output)</b> | 4.0 kVAC / < 10 mA | 4.0 kVAC / < 10 mA*<br>3.0 kVAC / < 15 mA | 3.0 kVAC / < 15 mA |           | 3.0 kVAC / < 10 mA |
| <b>Insulation / withstand voltage (output / GND)</b>   | 0.5 kVAC / < 10 mA | 0.5 kVAC / < 10 mA*<br>0.5 kVAC / < 15 mA | 0.5 kVAC / < 15 mA |           | 0.5 kVAC / < 10 mA |
| <b>Output / DC OK<sup>3</sup></b>                      | -                  | 30 VDC / 1A max. (resistive load)         |                    |           |                    |
| <b>Insulation resistance</b>                           | ≥ 50 MΩ            | ≥ 100 MΩ                                  | ≥ 50 MΩ            |           | ≥ 100 MΩ           |
| <b>Overvoltage category</b>                            | II                 |   |                    |           |                    |
| <b>Pollution degree</b>                                | 2                  |   |                    |           |                    |

- 3. applies to SPDE..R models only
- \* applies to SPDE241201 only

**Inputs**

|                            | SPDE..75           | SPDE..120          | SPDE..190          | SPDE..240 | SPDE..480 |
|----------------------------|--------------------|--------------------|--------------------|-----------|-----------|
| <b>Rated input voltage</b> | 100 VAC to 240 VAC |                    |                    |           |           |
| <b>Input voltage range</b> | 90 VAC to 264 VAC  |                    | 85 VAC to 264 VAC  |           |           |
|                            | 120 VDC to 370 VDC | 127 VDC to 370 VDC | 120 VDC to 370 VDC |           |           |
| <b>AC current (max)</b>    |                    |                    |                    |           |           |
| 115 VAC                    | <2.0 A             | <3.0 A* / <1.5 A   | <3.0 A             |           | <5.5 A    |
| 230 VAC                    | <1.0 A             | <1.6 A* / <0.75 A  | <1.5 A             |           | <2.5 A    |
| <b>Frequency range</b>     | 47 Hz to 63 Hz     |                    |                    |           |           |
| <b>Inrush current</b>      |                    |                    |                    |           |           |
| 115 VAC                    | 25 A               | 30 A* / 15 A       | 15 A               |           | 20 A      |
| 230 VAC                    | 45 A               | 55 A* / 30 A       | 30 A               |           | 40 A      |

\* applies to SPDE241201 only

**Outputs**

|  | SPDE..75   | SPDE..120  | SPDE..190                    | SPDE..240     | SPDE..480   |
|--|--|--|------------------------------|---------------|---|
| <b>Output power</b>                          | 75 W   | 120 W  | 192 W                        | 240 W         | 480 W   |
| <b>Voltage accuracy</b>                      | ±2 % (12 VDC)<br>±1 % (24/48 VDC)                                |  | ±2 %                         | ±1 %          | ±1%   |
| <b>Line regulation</b>                       | ±0.5 %   |  |                              |               |   |
| <b>Load regulation</b>                       | ±1.0 %   |  |                              |               |   |
| <b>Voltage regulation span</b>               |  |  |                              |               |   |
| <b>12 VDC</b>                                | 12 V to 14 V   | 12 V to 14 V   | 12 V to 14 V                 |               |   |
| <b>24 VDC</b>                                | 24 V to 28 V   | 24 V to 28 V   |                              | 24 V to 28 V  | 24 V to 28 V  |
| <b>48 VDC</b>                                | 48 V to 53 V   | 48 V to 55 V   |                              | 48 V to 53 V  | 48 V to 56 V  |
| <b>Rated output current</b>                  |  |  |                              |               |   |
| <b>12 VDC</b>                                | 6.3 A  | 10 A   | 16 A                         |               |   |
| <b>24 VDC</b>                                | 3.2 A  | 5 A  |                              | 10 A          | 20 A  |
| <b>48 VDC</b>                                | 1.6 A  | 2.5 A  |                              | 5 A           | 10 A  |
| <b>Ripple and noise<br/>20 MHz bandwidth</b> |  |  |                              |               |   |
| <b>12 VDC</b>                                | < 80 mV  | < 120 mV*<br>< 100 mV  | 75 - 150 mV                  | 75 - 150 mV** |   |
| <b>24 VDC</b>                                | < 120 mV   | < 100 mV   |                              | 60 - 120 mV   | <100 mV   |
| <b>48 VDC</b>                                | < 150 mV   | < 200 mV   |                              | 75 - 150 mV   | <120 mV   |
| <b>Hold up time</b>                          | ≥ 12 ms (115 VAC)<br>≥ 60 ms (230 VAC)                           | ≥ 8 ms (115 VAC)*<br>≥ 16 ms (230 VAC)*<br>≥ 20 ms           |                              | ≤ 20 ms       | ≤ 22 ms   |
| <b>Set-up time</b>                           | < 3 s  | 2.5 s (115 VAC)*<br>1.2 s (230 VAC)*<br>< 3 s                |                              | < 1 s         | < 3 s   |
| <b>Rise time</b>                             | -  | ≤ 60 ms*<br>≤ 100 ms   |                              | < 100 ms      | < 150 ms  |
| <b>Turn-on overshoot</b>                     | < 10 %   |  |                              |               |   |
| <b>Overshoot and undershoot</b>              | ±10%   |  | < 10 %                       |               | ±10%  |
| <b>Series operation</b>                      | Support output series boost voltage, it is suggested 15 mm space |  |                              |               |   |
| <b>Parallel operation</b>                    | No   |  |                              |               |   |
| <b>Power boost</b>                           | -  | 110%~150% of<br>rated output<br>current within<br>1 s* / 3 s | 150% of rated output current |               | 110%~150% of<br>rated output<br>current within<br>1 s |

\* applies to SPDE241201 only  
\*\* applies to SPDE242401 only

# Performance

## Current derating

### SPDE..75

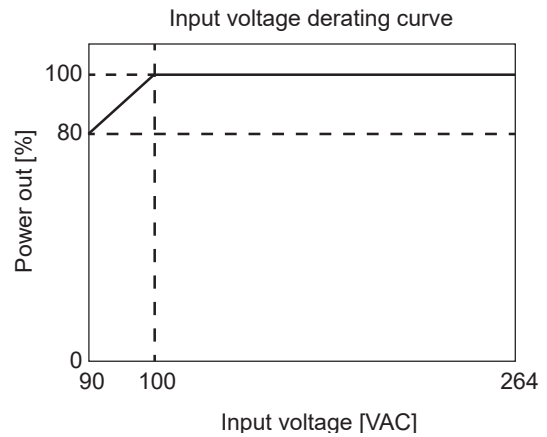
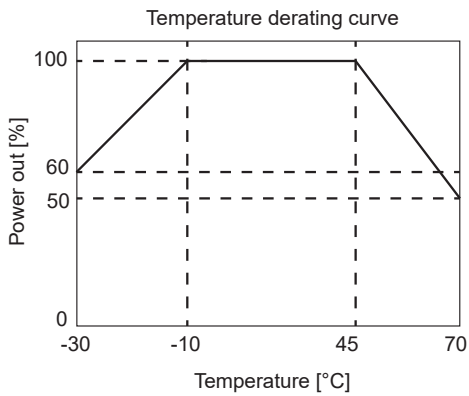

### SPDE241201

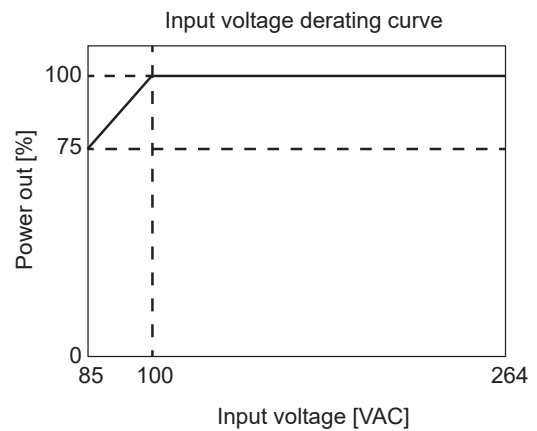
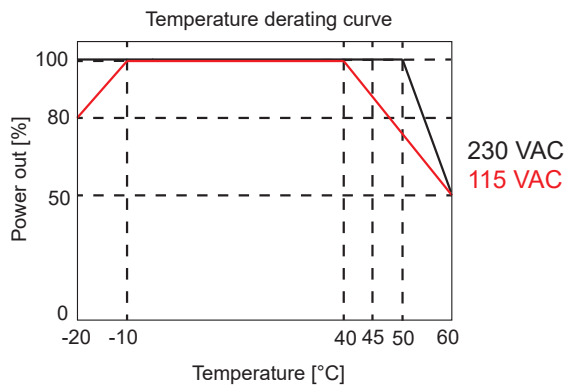

### SPDE..120

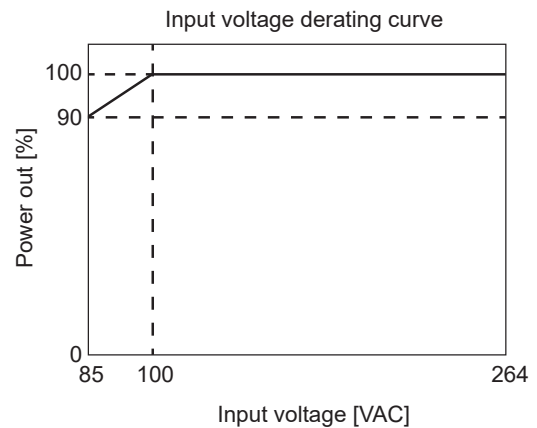
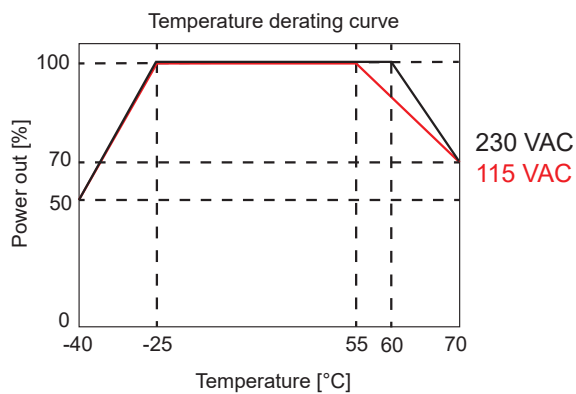

**SPDE..190**

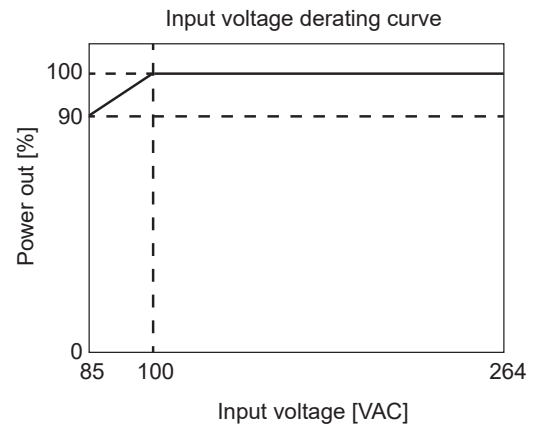
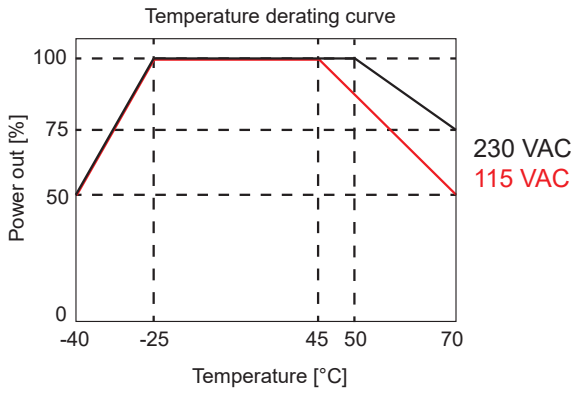

**SPDE242401**

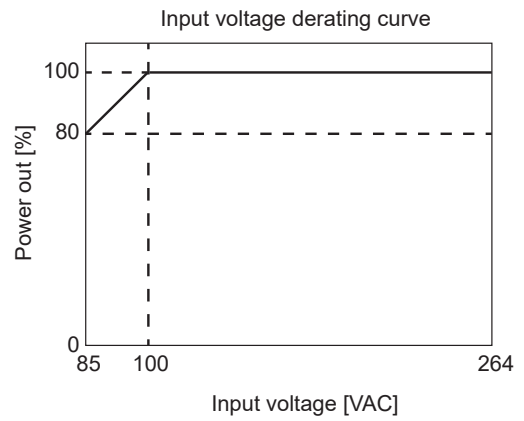
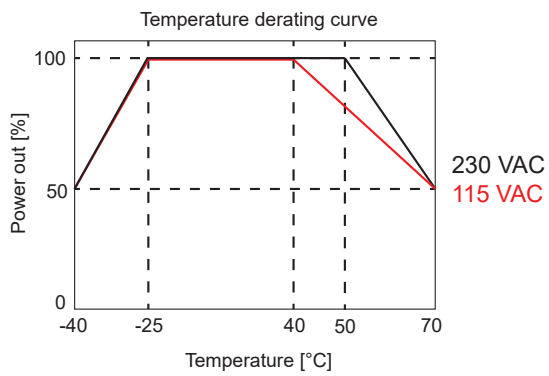

**SPDE..240**

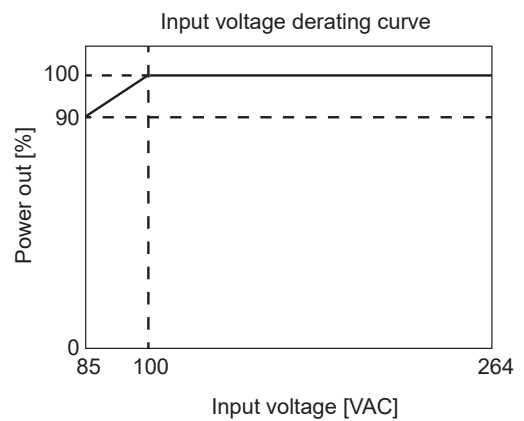
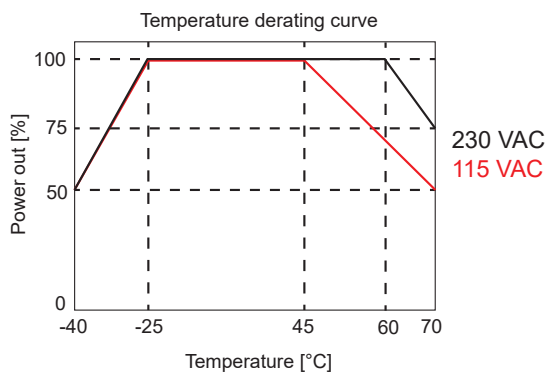

SPDE..480

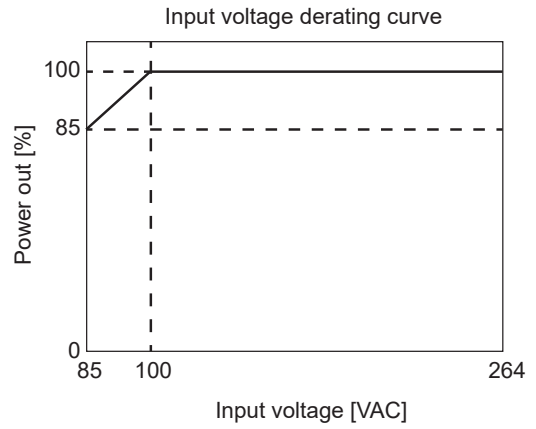
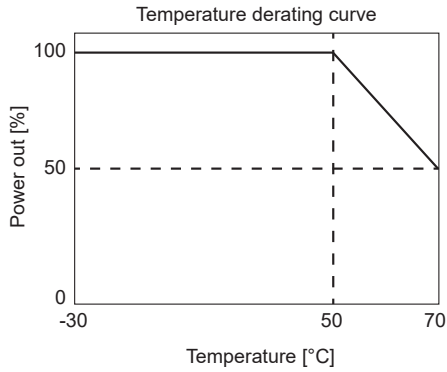

Efficiency

SPDE..75

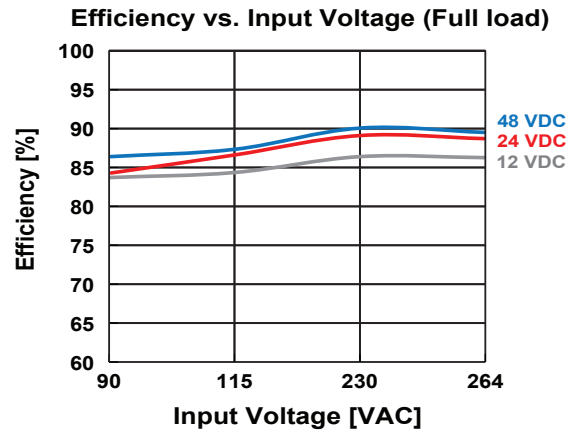
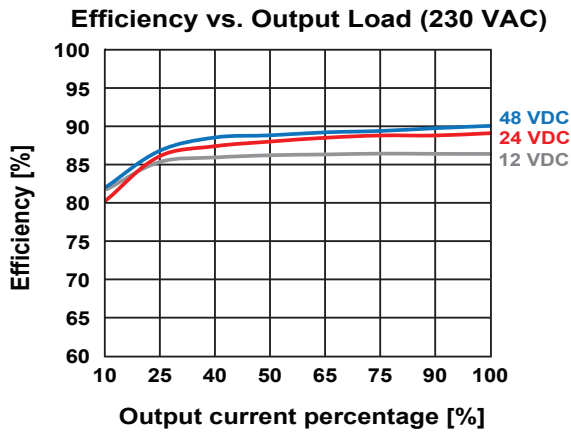

SPDE241201

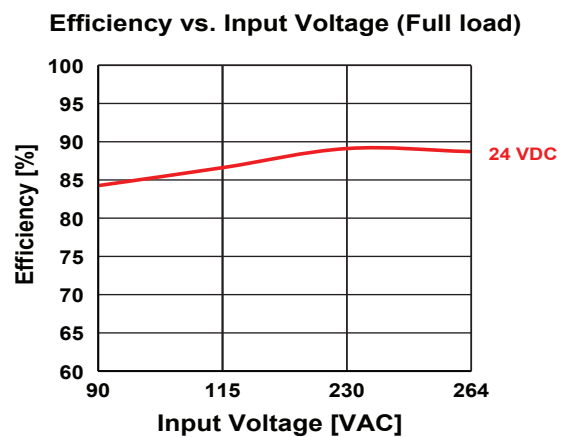
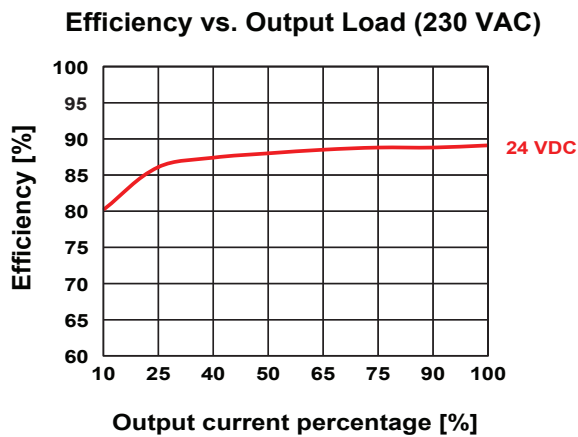

SPDE..120

Efficiency vs. Output Load (230 VAC)

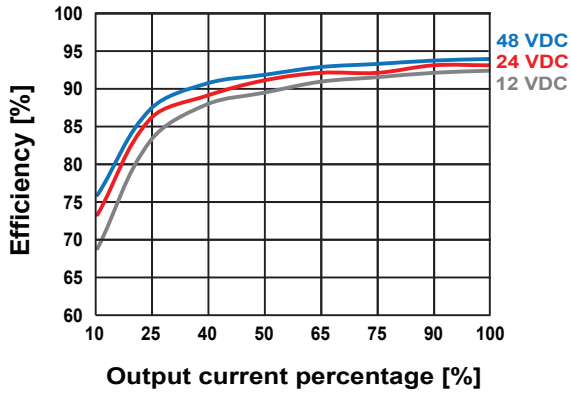

Efficiency vs. Input Voltage (Full load)

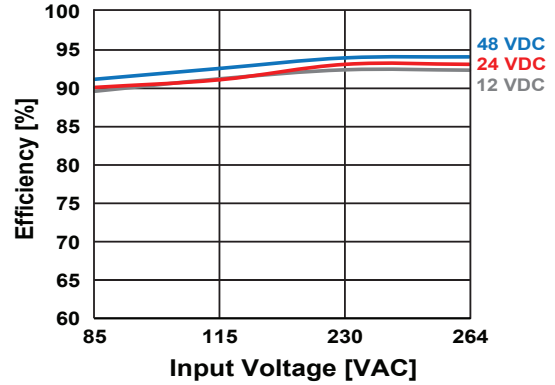

SPDE..190

Efficiency vs. Output Load (230 VAC)

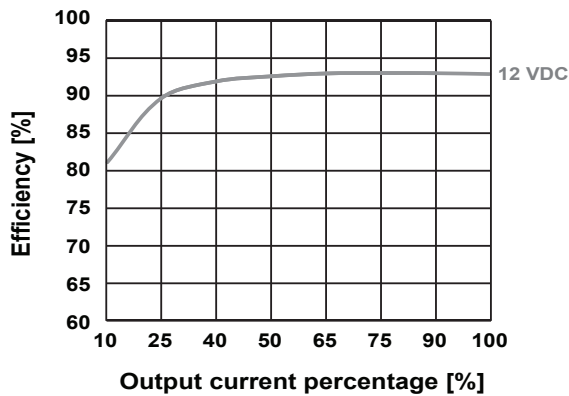

Efficiency vs. Input Voltage (Full load)

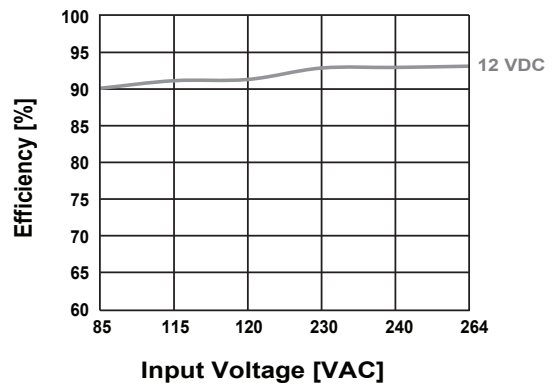

SPDE242401

Efficiency vs. Output Load (230 VAC)

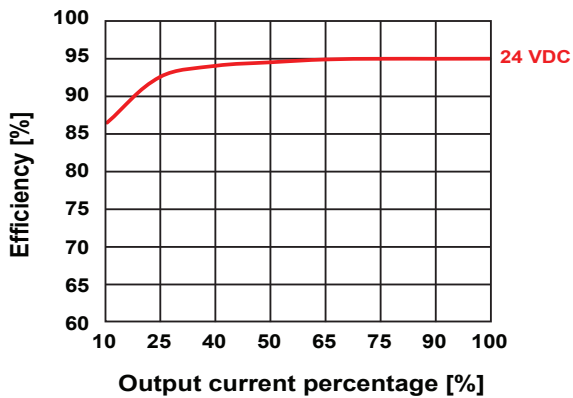

Efficiency vs. Input Voltage (Full load)

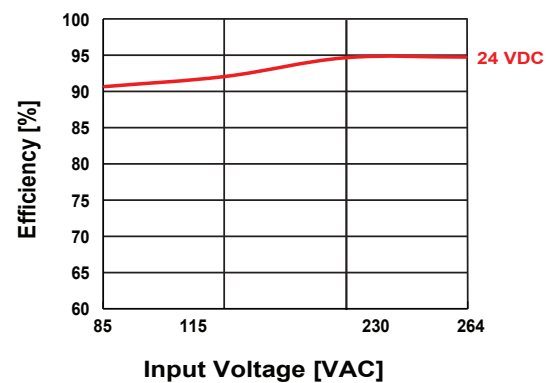

SPDE..240

Efficiency vs. Output Load (230 VAC)

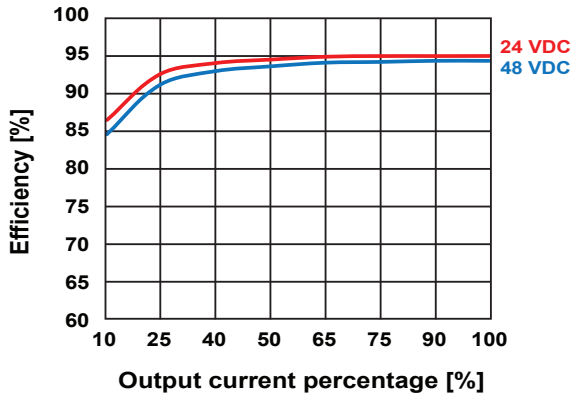

Efficiency vs. Input Voltage (Full load)

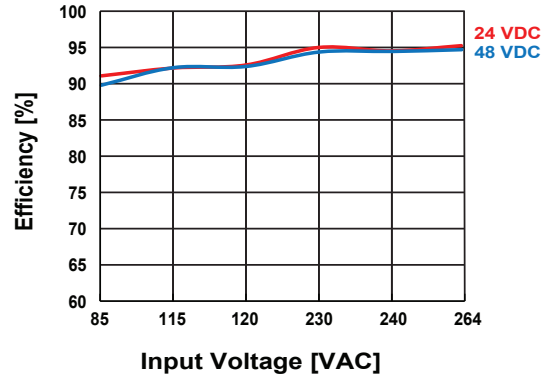

SPDE..480

Efficiency vs. Output Load (230 VAC)

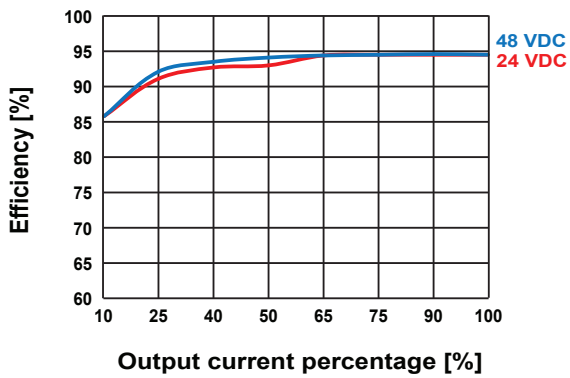

Efficiency vs. Input Voltage (Full load)

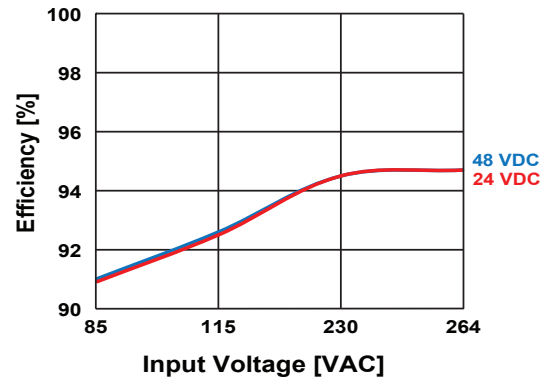

**Wiring diagram**

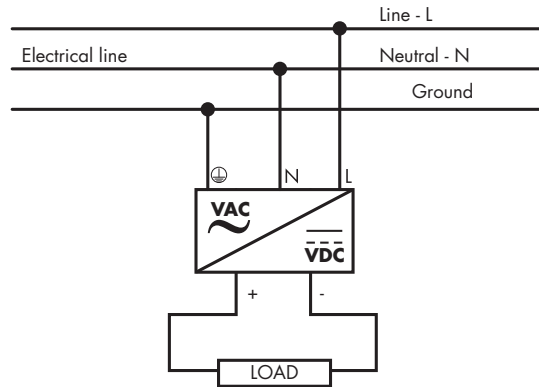

**Connection specification**

|   |               | SPDE..75                                  | SPDE..120                                   | SPDE..190                                 | SPDE..240                                | SPDE..480                                |
|---|---------------|---|---|---|--|--|
| <b>Terminal type</b>                              |               | Screw terminals with Phillips screw head  |   |   |  |  |
| <b>Screw driver blade</b>                         |               | 3.5 mm slotted or Phillips                |   |   |  |  |
| <b>Tightening torque (recommended)</b>            |               | 0.4 Nm                                    |   | 0.79 Nm                                   |  | 0.5 Nm                                   |
| <b>Conductor cross section (input terminals)</b>  |               | 0.14 - 6 mm <sup>2</sup><br>(26 - 10 AWG) | 0.14 - 6 mm <sup>2</sup><br>(26 - 10 AWG)   | 0.14 - 6 mm <sup>2</sup><br>(26 - 10 AWG) |  | 0.5 - 6 mm <sup>2</sup><br>(20 - 10 AWG) |
| <b>Conductor cross section (PE connection)</b>    |               |   |   | 4 - 6 mm <sup>2</sup><br>(12 - 10 AWG)    |  |  |
| <b>Conductor cross section (output terminals)</b> | <b>12 VDC</b> | 0.14 - 6 mm <sup>2</sup><br>(26 - 10 AWG) | 1.5 - 6 mm <sup>2</sup><br>(16 - 10 AWG)    | 4 - 6 mm <sup>2</sup><br>(12 - 10 AWG)    | -  |  |
|   | <b>24 VDC</b> |   | 0.5 - 6 mm <sup>2</sup><br>(20 - 10 AWG)    | -   | 1.5 - 6 mm <sup>2</sup><br>(16 - 10 AWG) | 2.5 - 6 mm <sup>2</sup><br>(14 - 10 AWG) |
|   | <b>48 VDC</b> |   | 0.34 - 6 mm <sup>2</sup><br>(22 - 10 AWG)   | -   | 1.0 - 6 mm <sup>2</sup><br>(18 - 10 AWG) |  |
| <b>DC OK relay output*</b>                        |               | -   | 0.25 - 1.5 mm <sup>2</sup><br>(24 - 16 AWG) |   |  |  |

\* applies to SPDE..R models only

Note: for SPDE241201 Conductor cross section (output terminals): 1.5 - 6 mm<sup>2</sup> (16 - 10 AWG)

**Block diagram**

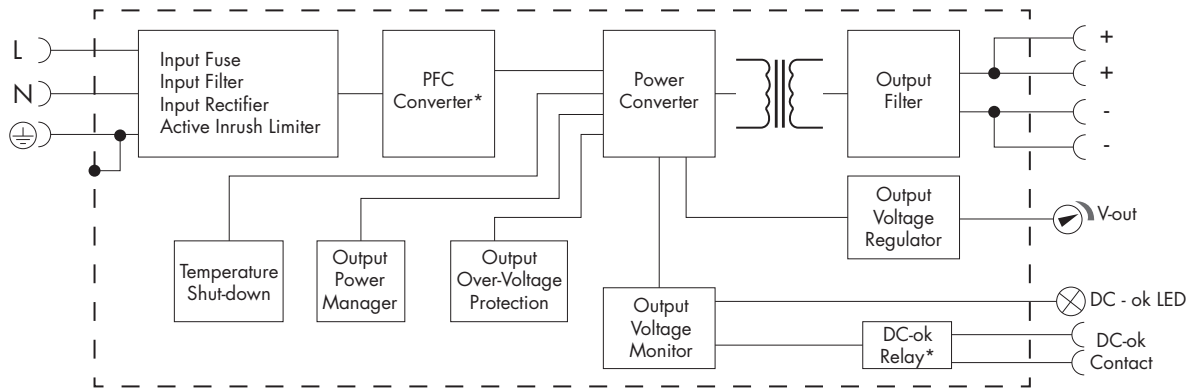

\* only in SPDE..R versions

## Operating description

**Control and protection**

|                                    |                                     | SPDE..75  | SPDE..120   | SPDE..190     | SPDE..240 | SPDE..480   |
|------------------------------------|-------------------------------------|---|---|---------------|-----------|---|
| <b>Oversvoltage protection</b>     |                                     |   |   |               |           |   |
|                                    | <b>12 VDC</b>                       | ≤ 17 V  | ≤ 16 V  | ≤ 18 V        |           |   |
|                                    | <b>24 VDC</b>                       | ≤ 33 V  | ≤ 33 V  |               | ≤ 35 V    | 29 - 35 V   |
|                                    | <b>48 VDC</b>                       | ≤ 60 V  | ≤ 60 V  |               | ≤ 60 V    | 56 - 60 V   |
| <b>Over-current protection</b>     | <b>100% ~ 150% of rated current</b> | Constant current mode, automatic recover after fault condition is removed |   | Self-recovery |           | The output turned off after working normally for 1 s, self-recovery |
|                                    | <b>&gt;150% of rated current</b>    |   |   |               |           | Automatic recover after fault condition is removed                  |
| <b>Current limiting</b>            |                                     | < 2 A   | < 2.7 A (115 VAC)*<br>< 1.6 A (230 VAC)*<br>< 1.5 A | < 4 A         |           | < 5.5 A   |
| <b>Short circuit protection</b>    |                                     | Constant current, continuous, self-recovery                               |   |               |           | Hiccup, continuous, self-recovery                                   |
| <b>Over temperature protection</b> |                                     | Output voltage turn off, re-power on for recover after the temp. drops.   | Output voltage turn off, re-power on for recover.   | 80°C          |           | 60°C to 90°C  |
| <b>Reverse voltage protection</b>  |                                     | No  |   |               |           |   |

\* applies to SPDE241201 only