

Circuit Breaker for Equipment thermal, Threaded neck type, Manual ON/OFF, Quick connect terminals



See below:

Approvals and Compliances

Description

- Threaded neck type
- Thermal circuit breaker
- 1-pole
- Manual ON/OFF type
- Quick connect terminals 6.3 x 0.8 mm

Unique Selling Proposition

- Compact design
- Positively trip-free release
- Available with cover
- Different mounting possibilities

Applications

- Power supplies
- Uninterruptible power supply
- Power tools
- Household appliances

Weblinks

[pdf data sheet](#), [html datasheet](#), [General Product Information](#), [Distributor-Stock-Check](#), [Detailed request for product](#), [Product News](#)

Technical Data

Rated Voltage AC	AC 240 VAC
Rated Voltage DC	28 VDC
Rated current range AC	0.05 - 15/16 A , see approbations
Conditional short circuit capacity I _{nc}	IEC 60934: PC1, AC 240 V: 1 kA
Short circuit capacity I _{cn}	IEC 60934: at I _n < 7 A/240 VAC : 8 x I _n IEC 60934: at I _n ≥ 7 A/240 VAC : 200 A AC/DC 28 V : 400 A
Degree of Protection	front side IP40 acc. to IEC 60529
Dielectric Strength	50Hz: > 1.5 kV Impulse 1.2/50 μs: > 2.5 kV
Insulation Resistance	500VDC > 100 MΩ
Endurance typical	2 x I _r : 5000 switching cycles
Endurance minimum	Manual ON/OFF type AC : 2 x I _r , cos φ 0.6 : DC : 2 x I _r , L/R = 2 - 3 ms : 5000 switching cycles

Overload	IEC: min. 40 trips @ 6 x I _r , cos φ 0.6 UL / CSA: min. 50 trips @ 1.5 x I _r , cos φ 0.75
Allowable Operation Temp.	-5 °C to 60 °C
Vibration Resistance	± 1.5 mm @ 10 - 60 Hz acc. to IEC 60068-2-6, test Fc 10 G @ 60 - 500 Hz acc. to IEC 60068-2-6, test Fc
Shock Resistance	100 G / 6ms acc. to IEC 60068-2-27, test Ea
Tripping Type	Thermal
Actuation Type	Manual ON/OFF
Weight	ca. 10g



Approvals and Compliances

Detailed information on product approvals, code requirements, usage instructions and detailed test conditions can be looked up in [Details about Approvals](#)

SCHURTER products are designed for use in industrial environments. They have approvals from independent testing bodies according to national and international standards. Products with specific characteristics and requirements such as required in the automotive sector according to IATF 16949, medical technology according to ISO 13485 or in the aerospace industry can be offered exclusively with customer-specific, individual agreements by SCHURTER.



Approvals

The approval mark is used by the testing authorities to certify compliance with the safety requirements placed on electronic products.
Approval Reference Type: T12

Approval Logo	Certificates	Certification Body	Description
	VDE Approvals	VDE	VDE Certificate Number: 99673
	UL Approvals	UL	UR File Number: E71572
	CCC Approvals	CCC	CCC Certificate Number: 2024010307710410

Product standards

Product standards that are referenced

Organization	Design	Standard	Description
	Designed according to	IEC 60934	Circuit-breakers for equipment (CBE)
	Designed according to	UL 1077	Standard for Supplementary Protectors for Use in Electrical Equipment
	Designed according to	CSA C22.2 No. 235	Supplementary Protectors
	Designed according to	GB 17701	Circuit-breaker for equipment





Application standards

Application standards where the product can be used

Organization	Design	Standard	Description
	Suitable for applications acc.	IEC/UL 62368-1	Audio/video, information and communication technology equipment - Part 1: Safety requirements

Compliances

The product complies with following Guide Lines

Identification	Details	Initiator	Description
	CE declaration of conformity	SCHURTER AG	The CE marking declares that the product complies with the applicable requirements laid down in the harmonisation of Community legislation on its affixing in accordance with EU Regulation 765/2008.
	UKCA declaration of conformity	SCHURTER AG	The UKCA marking declares that the product complies with the applicable requirements laid down in the British Amendment of Regulation (EC) 765/2008.
	RoHS	SCHURTER AG	Directive RoHS 2011/65/EU, Amendment (EU) 2015/863
	China RoHS	SCHURTER AG	The law SJ / T 11363-2006 (China RoHS) has been in force since 1 March 2007. It is similar to the EU directive RoHS.
	REACH	SCHURTER AG	On 1 June 2007, Regulation (EC) No 1907/2006 on the Registration, Evaluation, Authorization and Restriction of Chemicals 1 (abbreviated as "REACH") entered into force.

Dimension [mm]
 T12-211

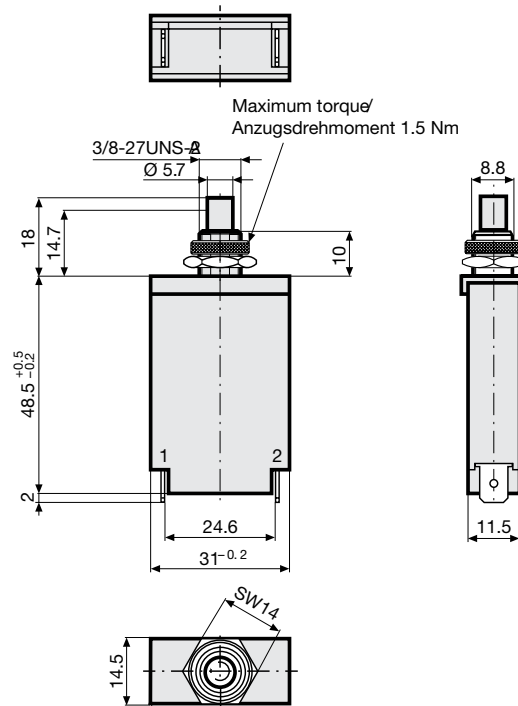

T12-211SN

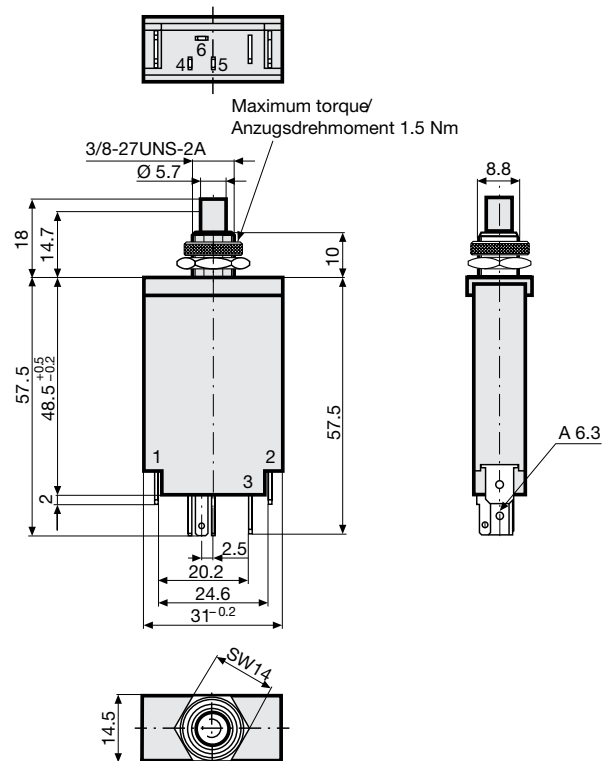

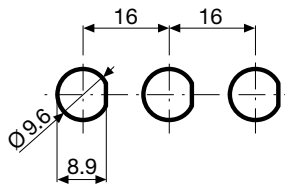

Diagrams

T12-...

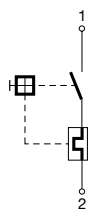

T12-...N

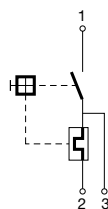

T12-...S

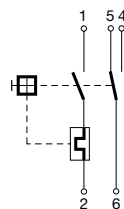

T12-...SN

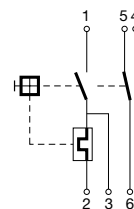

Approval	Main circuit			Auxiliary circuit		
	Rated current	Rated Voltage AC	Rated Voltage DC	Rated current	Rated Voltage AC	Rated Voltage DC
UL 1077 CSA C22.2 No. 235	0.05...15 A	240 V	28 V	2 A 3 A	120 V -	- 28 V
CSA C22.2 No. 235	0.3...16 A	240 V	28 V	1 A	240 V	-
IEC 60934	0.05...16 A	240 V	28 V	1 A	240 V	28 V
GB 17701	0.05...16 A	240 V	28 V	1 A	240 V	28 V

Typical internal resistance per pole

Rated Current [A]	Internal Resistance [Ω]
0.05	225.000
0.50	3.300
1.00	0.880
2.00	0.267
3.00	0.128
4.00	0.073
5.00	0.040
6.00	0.031
7.00	0.018
8.00	0.018
9.00	0.010
10.00	0.0087
11.00	0.0087
12.00	0.0087
13.00	0.0087
14.00	0.0070
15.00	0.0070
16.00	0.0055

Effect of ambient temperature

The units are calibrated for an ambient temperature of +23°C. To determine the rated current for a lower or higher ambient temperature, use a correction factor (typical value) from the table below:

Ambient Temperature [°C]	Correction factor
-5	0.87
0	0.90
10	0.95
23	1.00
30	1.05
40	1.12
50	1.20
60	1.30

Example: Rated current = 5 A, Environmental temperature = 50 °C, --> Correction factor = 1.2, Resulting current = 6.0 A

Time-Current-Curves

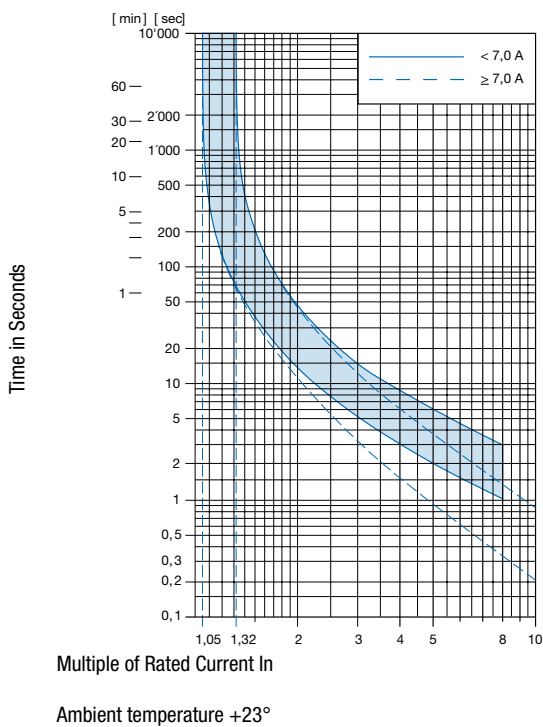

Config. Code

T12 - 1 2 3 A B C - 1.23

The characters are placeholders for the correspondingly keys of selections from the key tables.

T12 - **1** 2 3 A B C - 1.23 = Mounting

Mounting	Configuration key
Threaded neck type with hexagonal- and knurled nut	2

T12 - 1 **2** 3 A B C - 1.23 = Actuation Type

Actuation Type	Configuration key
Manual ON/OFF (push/push)	2

T12 - 1 2 **3** A B C - 1.23 = Terminal

Terminal	Configuration key
Quick connect terminal 6.3x0.8mm	1

T12 - 1 2 3 **A** B C - 1.23 = Auxiliary contact

Auxiliary contact	Configuration key
Auxiliary contact	S

T12 - 1 2 3 A **B** C - 1.23 = Shunt terminal

Shunt terminal	Configuration key
Shunt terminal	N

T12 - 1 2 3 A B C - 1.23 = Setting indication

Setting indication	Configuration key
Setting indication	R

T12 - 1 2 3 A B C - 1.23 = Rated current

Rated current	Configuration key
0.05 A	0.05
0.1 A	0.1
0.15 A	0.15
0.2 A	0.2
0.3 A	0.3
0.4 A	0.4
0.5 A	0.5
0.6 A	0.6
0.7 A	0.7
0.8 A	0.8
0.9 A	0.9
1.0	1
1.1 A	1.1
1.2 A	1.2
1.3 A	1.3
1.4 A	1.4
1.5 A	1.5
1.6 A	1.6
1.7 A	1.7

Other rated currents on request

Rated current	Configuration key
1.8 A	1.8
1.9 A	1.9
2.0 A	2
2.1 A	2.1
2.3 A	2.3
2.5 A	2.5
2.8 A	2.8
3.0 A	3
3.3 A	3.3
3.5 A	3.5
4.0 A	4
4.5 A	4.5
5.0 A	5
5.5 A	5.5
6.0	6
6.5 A	6.5
7.0 A	7
7.5 A	7.5
8.0 A	8
8.5 A	8.5
9.0 A	9
9.5 A	9.5
10.0 A	10
11.0 A	11
12.0 A	12
13.0 A	13
14.0 A	14
15.0 A	15
16.0 A	16

Other rated currents on request

Variants

Rated Current [A]	Construction variants			Config. Code	Order Number
	Auxiliary contact	Shunt terminal	Setting indication		
1.5	●			T12-221S-1.5	4410.0209
2	●			T12-221S-2	4410.0215
3				T12-221-3	4410.0004
5				T12-221-5	4410.0018
10				T12-221-10	4410.0015

Availability for all products can be searched real-time: <https://www.schurter.com/en/info-center/support-tools/stock-check-distributors>

Packaging Unit

20 Pcs

Accessories

Description



T-Line_Accessories
Accessories to T-Line