

Outdoor

# UHF/700/800+GNSS Direct Mount 2-in-1 Antenna

SKF490758L125DM(W) – 470-512 / 750-960 MHz GNSS L1, L2, L5



### Features & Applications:

- Vehicle roof mount, directly on metal plane
- Port 1; 470-512 / 750-960MHz
- Port 2; Active GNSS L1, L2 & L5 with low noise 30dB amplifier
- Cable / length; RG-58 / 17ft (5.2m)
- GNSS Cable / length; RG-174 / 17ft (5.2m)
- Connector; SMA-Male
- Available in Black (P/N SKF490758L125DM) or White (P/N SKF490758L125DMW)
- Heavy and light vehicles
- IoT, navigation, tracking

### Electrical specifications @ 25° C

#### Frequency Band – 470-512 / 750-960 MHz

Antenna type	Nominal Impedance	Polarization	Radiation pattern	Power withstanding	DC Ground
Dipole	50Ω	Vertical	Omni	45W	Yes

Frequency (MHz)	470-512	750-960
VSWR W/17FT (5.2M) Cable	2.5:1	2:1
Avg. Peak Gain (dBi)	3.0	3.5
Avg. Efficiency (%)	68	61
HPBW Vertical Plane (°)	44	32

#### GNSS Antenna: Frequency Bands – L1, L2 & L5

Frequency (MHz)	L1: 1561-1602	L2: 1215-1237	L5: 1164-1189
Return Loss (dB)	< -10	< -13	< -15
Gain – Radiating Element (dBic)	3.6	0.3	-0.4
Average Efficiency (%)	70	60	46
LNA Gain (dB) Typical	28	33	30
Noise Figure (dB)	1.7 @ 1575MHz	2.2 @ 1227MHz	2.2 @ 1164MHz
Polarization	RHCP		
Operating Voltage (V)	2.5 - 18		
Power Consumption	Max. 16mA		

### Mechanical Specifications

#### SKF490758L125DM

Size W/H/L	Color	Weight	Cable / Connector Type	Fixing System
52.5 (2.07") x 63.6 (2.50") x 178.3 (7.02") mm	Black	375grms (0.83lbs)	RG-58 / SMA-Male RG-174 / SMA-Male	Direct Mount
Housing Material	Operating Temperature	Storage Temperature	Ingress Protection	RoHS-6 Compliant
UV Protected Plastic	-40°C to +85°C	-40°C to +85°C	IP67	Yes

Notes:

1. Measured on Ø52in (1.3m) ground plane.
2. Requires Ø.875" (22.3mm) hole.

# Outdoor UHF/700/800+GNSS Direct Mount 2-in-1 Antenna

SKF490758L125DM(W) – 470-512 / 750-960 MHz GNSS L1, L2, L5



## Test Setup / Charts

### SKF490758L125DM



antenna sample measured on  $\varnothing 52\text{in}$  (1.3m) ground plane

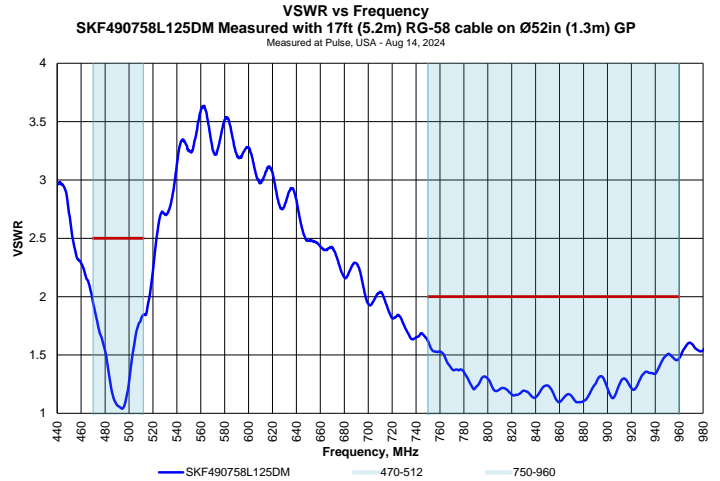

**Peak Gain vs Frequency**  
SKF490758L125DM Measured with 1ft (0.3m) RG-58 cable on  $\varnothing 52\text{in}$  (5.2m) GP  
Measured at Pulse, USA - Feb 05, 2024

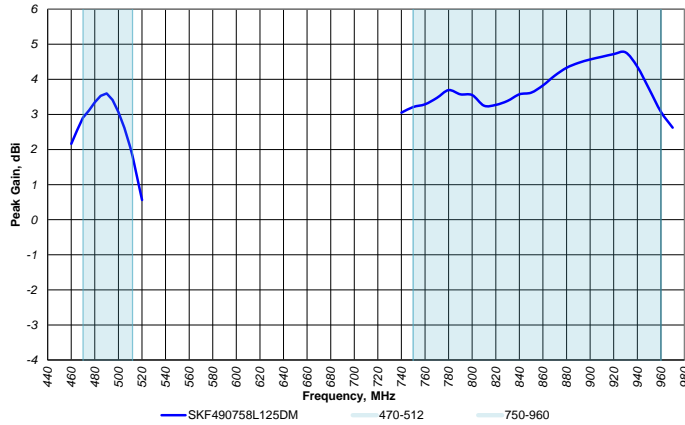

**Efficiency vs Frequency**  
SKF490758L125DM Measured with 1ft (0.3m) RG-58 cable on  $\varnothing 52\text{in}$  (5.2m) GP  
Measured at Pulse, USA - Feb 05, 2024

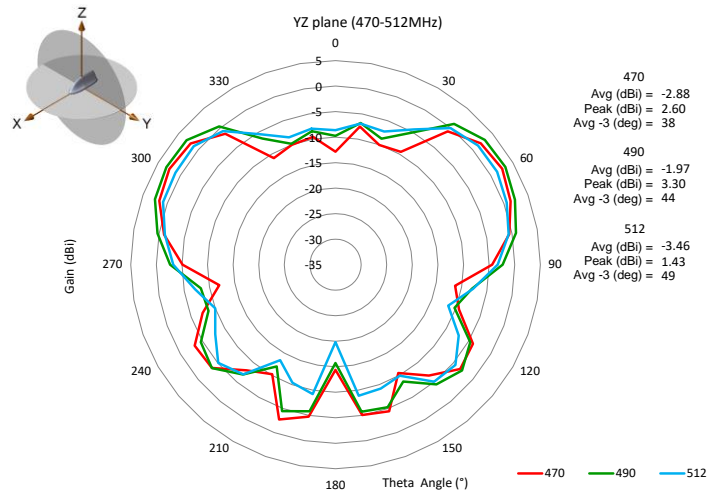
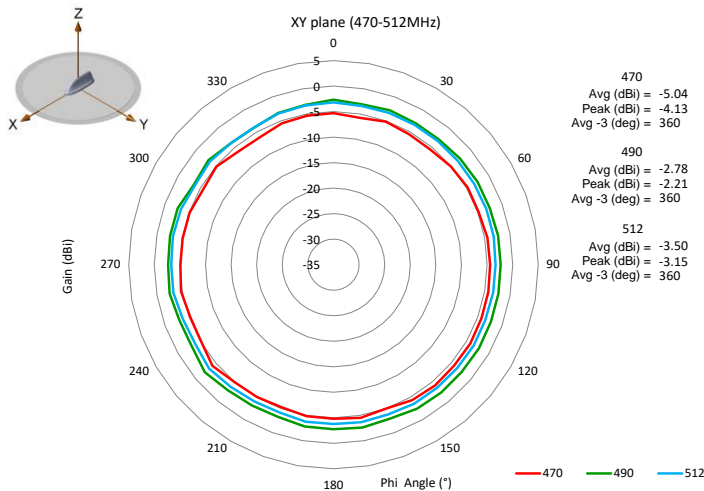
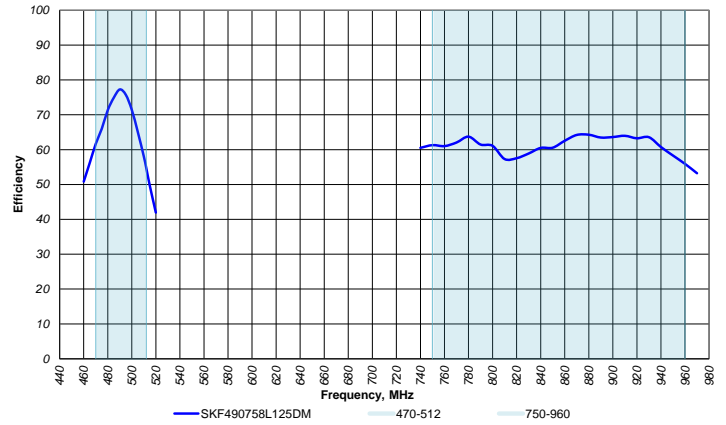

# Outdoor UHF/700/800+GNSS Direct Mount 2-in-1 Antenna

SKF490758L125DM(W) – 470-512 / 750-960 MHz GNSS L1, L2, L5

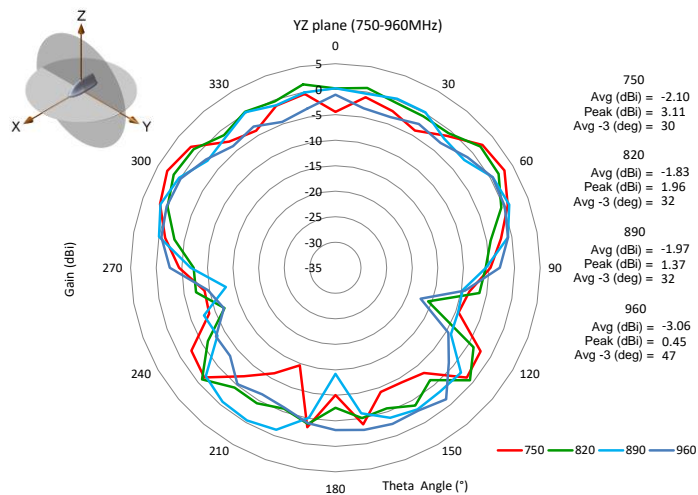
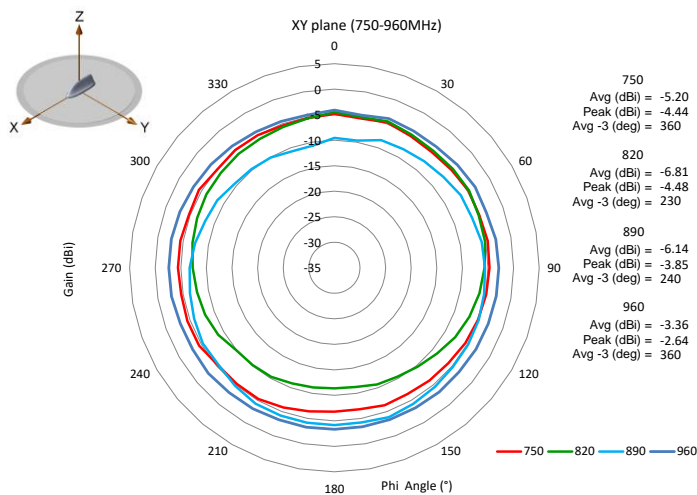

## LNA Gain and out-of-band rejection.

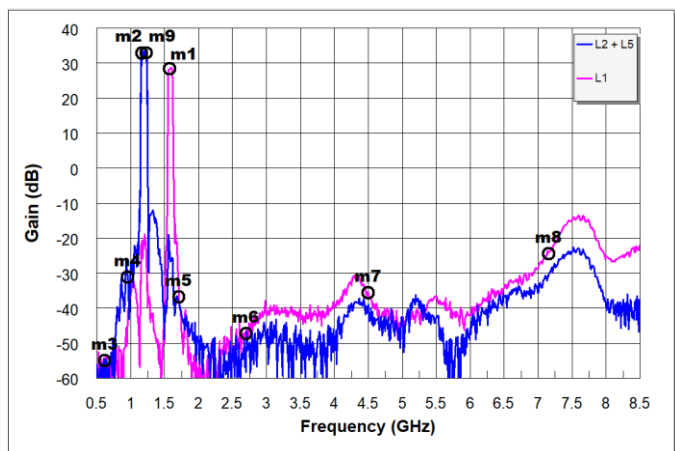

L1 RHCP Pattern

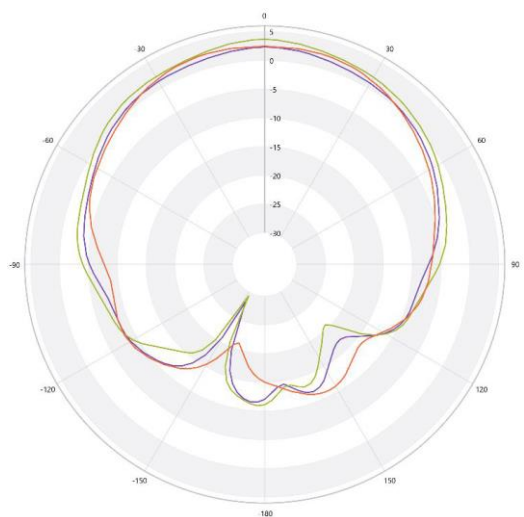

L2 + L5 RHCP Pattern

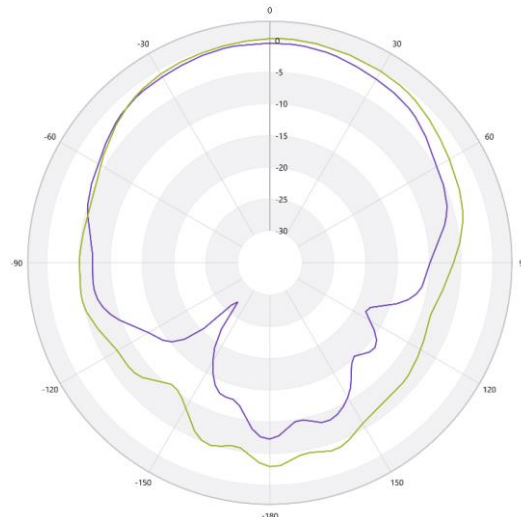

# Outdoor UHF/700/800+GNSS Direct Mount 2-in-1 Antenna

SKF490758L125DM(W) – 470-512 / 750-960 MHz GNSS L1, L2, L5



## Mechanical Drawing

SKF490758L125DM

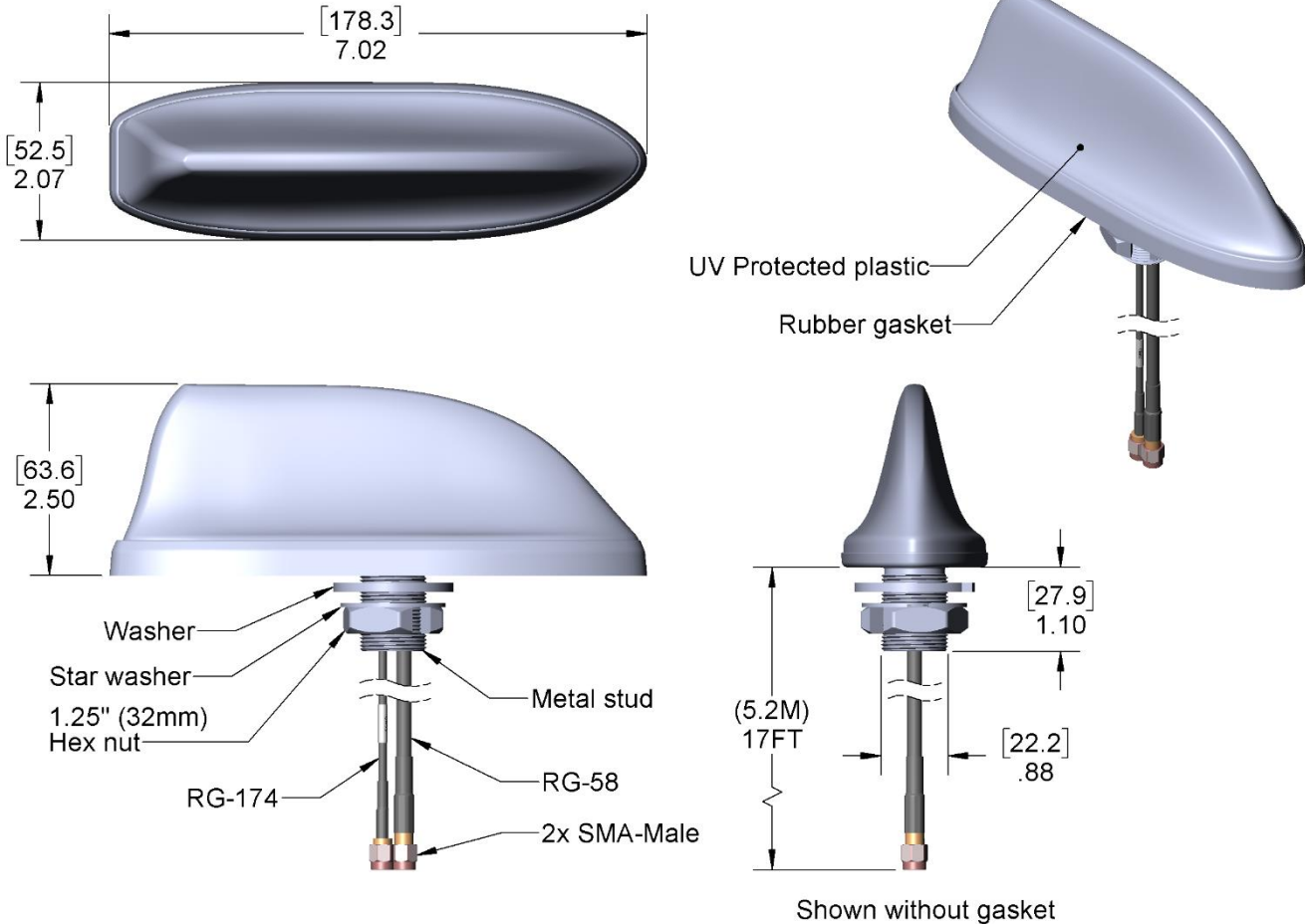

Dimensions: Inches (mm)  
Unless otherwise specified, all tolerances are  $\pm 0.020$  (0.5mm)

## Packaging

SKF490758L125DM

- 1 antenna packed in a plastic bag.
- 1 label on each plastic bag with part number, description, date code.

### Notes:

- Please contact sales for availability, lead time, and/or any special requests. Samples available upon request.
- Similar product: SKF450758L125DM (UHF band 440-470MHz).

### For More Information:

Americas - [antennas.us@pulseelectronics.com](mailto:antennas.us@pulseelectronics.com) | Europe - [antennas.eu@pulseelectronics.com](mailto:antennas.eu@pulseelectronics.com) | Asia - [antennas.as@pulseelectronics.com](mailto:antennas.as@pulseelectronics.com) | Questions? +1-800-ANTENNA  
Performance warranty of products offered on this data sheet is limited to the parameters specified. Data is subject to change without notice. Other brand and product names mentioned herein may be trademarks or registered trademarks of their respective owners. © Copyright , 2020. Pulse Electronics, Inc. All rights reserved.  
Company address: Pulse Electronics, a YAGEO Company, 15255 Innovation Drive, Suite #100, San Diego, CA 92128

**'YAGEO Corporation and its affiliates do not recommend the use of commercial, automotive, and/or COTS grade products for high reliability applications or manned space flight.'**