

Switch mode power supplies

78
SERIES



Building automation



Elevators and lifts



Automation for blinds, grilles and shutters



Hoists and cranes



Panels for electrical distribution



Pump Control



12 W Low profile Modular DC Power Supplies for electrical cabinets

Type 78.12...1200

- Output 12 V DC, 12 W, 1.25 A

Type 78.12...2400

- Output 24 V DC, 12 W, 0.63 A

- Designed for SELV system (EN 60950)
- 17.5 mm (1 module) x 61 mm deep
- Low stand-by power consumption
- Thermal protection: internal, with V_{out} shutdown - power OFF to reset
- Short circuit protection: Hiccup (auto-recovery) mode
- Overvoltage protection: Varistor
- Flyback topology
- Compliant with EN 60950-1 and EN 61204-3
- Parallel working for automatic redundancy - with OR diodes
- Dual Polarity and Series connection permissible
- 35 mm rail (EN 60715) mount

78.12
Box clamp



For outline drawing see page 37

78.12...1200



- 12 V DC, 12 W output
- SELV
- General use for 12 V DC load

78.12...2400



- 24 V DC, 12 W output
- SELV
- General use for 24 V DC load

- * (see diagrams P78)
- ** peak to peak, 100 Hz component, with 100 V AC input
- *** 88...100 V AC with output current limited to 80% I_N
- **** (see derating diagrams L78)

Output specification		78.12...1200	78.12...2400
Output current (-20...+40 °C, 230 V AC input)	A	1.25	0.63
Rated current I_N (50 °C, full input operating range)	A	1	0.50
Rated voltage	V	12	24
Rated power	W	12	12
Output power (-20...+40 °C, 230 V AC input)	W	15	15
Peak current capability for 3 ms*	A	2	2
Voltage variation (from no-load to full-load)		< 1%	< 1%
Voltage ripple @ full load**	mV	< 200	< 200
Hold-up time @ full load:	with 100 V AC input ms	> 10	> 10
	with 260 V AC input ms	> 90	> 90
Input specification		78.12...1200	78.12...2400
Nominal voltage (U_N)	V AC (50/60 Hz)	110...240	110...240
	V DC (not polarized)	220	220
Operating range	V AC (50/60 Hz)	100...265***	100...265***
	V DC	140...370	140...370
Max power consumption (@ 110 V AC, 50 Hz)	VA	32	28.2
	W	17.2	14.2
Stand-by power consumption (@ 230 V AC)	W	< 0.4	< 0.4
Power factor		0.53	0.50
Max current consumption (@ 88 V AC)	A	0.30	0.25
Max. inrush current (peak @ 265 V AC) for 3 ms	A	10	10
Technical data		78.12...1200	78.12...2400
Efficiency (@ 230 V AC)	%	87	85
MTTF	h	> 400 · 10 ³	> 400 · 10 ³
Start-up delay	s	< 1	< 1
Dielectric strength between input/output	V AC	3000	3000
Ambient temperature range****	°C	-20...+60	-20...+60
Protection category		IP 20	IP 20
Approvals (according to type)			

12 W Low profile Modular DC Power Supplies for electrical cabinets

Type 78.12...1202

- Output 12 V DC, 12 W, 1 A
- Modular LED driver for stripes and up to 12 W
- Suitable for general use (15 W - 40 °C, 12 W - 45 °C)

Type 78.12...2402

- Output 24 V DC, 12 W, 0.5 A
- Modular LED driver for stripes and up to 12 W, TUV certified following IEC61347-2-13
- Suitable for general use (15 W - 40 °C, 12 W - 50 °C)

- Designed for SELV system (EN 60950)
- 17.5 mm (1 module) x 61 mm deep
- Low stand-by power consumption
- Thermal protection: internal, with V_{out} shutdown - power OFF to reset
- Short circuit protection: (auto-recovery)
- Overvoltage protection: Varistor
- Flyback topology
- Compliant with EN 60950-1 and EN 61204-3
- Parallel working for automatic redundancy - with OR diodes
- Dual Polarity and Series connection permissible
- 35 mm rail (EN 60715) mount

NEW 78.12...1202



- 12 V DC, 12 W output
- SELV
- Modular LED driver with 12 V DC output
- General use for 12 V DC load

78.12...2402



- 24 V DC, 12 W output
- SELV
- Modular LED driver with 24 V DC output
- General use for 24 V DC load

78.12
Box clamp



For outline drawing see page 37

* (see diagrams P78)

** (see derating diagrams L78)

Output specification

Maximum continuous output current @ 40 °C, 230 V AC	LED driver	A	1	0.5
	General USE	A	1.25	0.63
Nominal current I _N	LED driver (40 °C)	A	1	0.5
-20...+40...+50 °C, 230 V AC	General USE (50 °C)	A	1	0.5
Rated voltage		V	12	24
Rated power		W	12	12
Maximum power @ 40 °C, 230 V AC	LED driver	W	12	12
	General USE	W	15	15
Peak current capability for 3 ms*		A	2	2
Voltage variation (from no-load to full-load)			< 1%	< 1%
Voltage ripple @ full load		mV	< 200	< 200
Hold-up time @ full load:	with 110 V AC input	ms	> 10	> 10
	with 240 V AC input	ms	> 90	> 90

Input specification

Nominal voltage (U _N)	V AC (50/60 Hz)	110...240	110...240
	V DC (not polarized)	220	220
Operating range	V AC (50/60 Hz)	100...265	100...265
	V DC	140...370	140...370
Max power consumption (@ 110 V AC, 50 Hz)	VA	32	28.2
	W	15	14.2
Stand-by power consumption (@ 230 V AC)	W	< 0.35	< 0.4
Power factor		0.45	0.50
Max current consumption (@ 100 V AC)	A	0.23	0.25
Max. inrush current (peak @ 265 V AC) for 3 ms	A	10	10

Technical data

Efficiency (@ 230 V AC)	%	85	85
MTTF	h	> 400 · 10 ³	> 400 · 10 ³
Start-up delay	s	< 1	< 1
Dielectric strength between input/output	V AC	3000	3000
Ambient temperature range**	°C	-20...+40	-20...+40
Protection category		IP 20	IP 20

Approvals (according to type)



Low profile Modular DC 12 W or 25 W Power Supplies designed for OPTA and expansion modules (8A series)

Type 78.12...2482

- Output 24 V DC - 0.5 A, 12 W
- Power supply switching for OPTA PLR - 8A Series

Type 78.25...2482

- Output 24 V DC - 1 A, 25 W
- Power supply switching for OPTA PLR - 8A Series
- Designed for SELV system (EN 60950)
- 17.5 mm (12 W) or 35 mm (25 W) x 61 mm deep
- Low stand-by power consumption
- Thermal protection: internal, with V_{out} shutdown - power OFF to reset
- Short circuit protection: (auto-recovery)
- Overvoltage protection: Varistor
- Compliant with EN 60950-1 and EN 61204-3
- Parallel working for automatic redundancy - with or diodes
- Dual Polarity and Series connection permissible
- 35 mm rail (EN 60715) mount

78.12/78.25
Box clamp



For outline drawing see page 37

Output specification

Maximum continuous output (-20...+50 °C, 230 V AC input)	A	0.50	1
Nominal current I _N (@ 70 °C)	A	0.40	0.8
Rated voltage	V	24	24
Rated power	W	12	25
Output power (-20...+50 °C)	W	12	25
Peak current capability for 3 ms*	A	2	3
Voltage variation (from no-load to full-load)		< 1%	< 1%
Voltage ripple @ full load	mV	< 200	< 200
Hold-up time @ full load:			
with 110V AC input ms		> 10	> 10
with 250V AC input ms		> 90	> 80

Input specification

Nominal voltage (U _N)	V AC (50/60 Hz)	110...240	110...240
	V DC (not polarized)	220	220
Operating range	V AC (50/60 Hz)	100...265	100...265
	V DC	140...370	140...370
Max power consumption (@ 110V AC, 50 Hz)	VA	28.2	55
	W	14.2	27
Stand-by power consumption (@ 230 V AC)	W	< 0.4	< 0.45
Power factor		0.50	0.48
Max current consumption (@ 110 V AC)	A	0.25	0.50
Max. inrush current (peak @ 250 V AC) for 3 ms	A	10	15

Technical data

Efficiency (@ 230 V AC)	%	85	89
MTTF	h	> 400 · 10 ³	> 400 · 10 ³
Start-up delay	s	1	1
Dielectric strength between input/output	V AC	3000	3000
Ambient temperature range**	°C	-20...+50	-20...+50
Protection category		IP 20	IP 20

Approvals (according to type)

78.12...2482



- Output 24 V DC, 12 W SELV
- Up to 1 OPTA and 5 expansion modules

NEW 78.25...2482



- Output 24 V DC, 25 W, SELV
- Up to 2 groups of 1 OPTA and 5 expansion modules

* (see diagrams P78)

** (see derating diagrams L78)

**25 W Low profile Modular DC
Power Supplies for electrical cabinets**
Type 78.25...1202

- Output 12 V DC, 25 W
- 35 mm (2-module) x 61 mm deep

- Designed for SELV system (EN 60950)
- Low stand-by power consumption
- Thermal protection: internal, with V_{out} shutdown - power OFF to reset
- Short circuit protection: (auto-recovery)
- Overvoltage protection
- Compliant with EN 60950-1 and EN 61204-3
- Parallel working for automatic redundancy - with OR diodes
- Dual Polarity and Series connection permissible
- 35 mm rail (EN 60715) mount

78.25
Box clamp



NEW 78.25...1202



- 12 V DC, 25 W output
- SELV

* (see diagrams P78)

** (see derating diagrams L78)

For outline drawing see page 37

Output specification

Output current (-20...+50 °C, 230 V AC input)	A	2.0
Output current (@ 70 °C)	A	1.6
Rated voltage	V	12
Rated power	W	25
Output power (-20...+50 °C)	W	25
Peak current capability for 3 ms*	A	4
Voltage variation (from no-load to full-load)		< 1%
Voltage ripple @ full load	mV	< 200
Hold-up time @ full load:	with 110 V AC input ms	> 10
	with 250 V AC input ms	> 100

Input specification

Nominal voltage (U_N)	V AC (50/60 Hz)	110...240
	V DC (not polarized)	220
Operating range	V AC (50/60 Hz)	100...265
	V DC	140...370
Max power consumption (@ 110 V AC, 50 Hz)	VA	58
	W	28
Stand-by power consumption (@ 230 V AC)	W	≤ 0.35
Power factor		0.48
Max current consumption (@ 110 V AC)	A	0.55
Max. inrush current (peak @ 250 V AC) for 3 ms	A	15

Technical data

Efficiency (@ 230 V AC)	%	88
MTTF	h	> 400 · 10 ³
Start-up delay	s	1
Dielectric strength between input/output	V AC	3000
Ambient temperature range**	°C	-20...+70
Protection category		IP 20

Approvals (according to type)



25 W Low profile Modular DC Power Supplies for electrical cabinets

Type 78.25...2400

- Output 24 V DC, 25 W
- 35 mm (2-module) x 61 mm deep

- Low stand-by power consumption
- Thermal protection: internal, with V_{out} shutdown - power OFF to reset
- Short circuit protection: Hiccup (auto-recovery)
- Overvoltage protection: Varistor
- Flyback topology
- Compliant with EN 60950-1 and EN 61204-3
- Parallel working for automatic redundancy - with OR diodes
- Dual Polarity and Series connection permissible
- 35 mm rail (EN 60715) mount

78.25
Box clamp



For outline drawing see page 37

Output specification

Output current (-20...+40 °C, 230 V AC input)	A	1
Rated current I_N (50 °C, full input operating range)	A	0.75
Rated voltage	V	24
Rated power	W	25
Output power (-20...+40 °C, 230 V AC input)	W	25
Peak current capability for 3 ms*	A	3
Voltage variation (from no-load to full-load)		< 1%
Voltage ripple @ full load**	mV	< 200
Hold-up time @ full load:	with 110 V AC input ms	> 40
	with 250 V AC input ms	> 100

Input specification

Nominal voltage (U_N)	V AC (50/60 Hz)	110...240
	V DC (not polarized)	220
Operating range	V AC (50/60 Hz)	100...265***
	V DC	140...370
Max power consumption (@ 110 V AC, 50 Hz)	VA	56.4
	W	27.5
Stand-by power consumption (@ 230 V AC)	W	≤ 0.5
Power factor		0.50
Max. current consumption (@ 88 V AC)	A	0.43
Max. inrush current (peak @ 265 V AC) for 3 ms	A	20

Technical data

Efficiency (@ 230 V AC)	%	89
MTTF	h	> 400 · 10 ³
Start-up delay	s	< 1
Dielectric strength between input/output	V AC	2500
Ambient temperature range****	°C	-20...+60
Protection category		IP 20

Approvals (according to type)

78.25...2400



- 24 V DC, 25 W output

* (see diagrams P78)
 ** peak to peak, 100 Hz component, with 100 V AC input
 *** 88...100 V AC with output current limited to 80% I_N
 **** (see derating diagrams L78)



**36 W High efficiency, low profile
Modular DC Power Supplies for electrical
cabinets**
Type 78.36 - 2402

- Output 24 V DC, 36 W

Type 78.36 - 1202

- Output 12 V DC, 36 W

- High efficiency (up to 90%)
- Designed for SELV system (EN 60950)
- Suitable for backup battery systems
- Low stand-by power consumption
- Thermal protection: internal, with V_{out} shutdown - power OFF to reset
- Short circuit protection: Hiccup (auto-recovery) mode
- Overvoltage protection: Varistor
- Flyback topology
- ZVS (Zero-voltage-switching), quasi-resonant mode switching
- Compliant with UL 61010 and EN 61204-3
- Parallel working for automatic redundancy - with OR diodes
- Dual Polarity and Series connection permissible
- Compact dimensions: 70 mm (4-modules) wide, 61 mm deep
- 35 mm rail (EN 60715) mount

78.36
Box clamp



For outline drawing see page 37

Output specification

Output current (-20...+40 °C, 230 V AC input)	A	1.7	3.3
Rated current I_N 50 °C, input (100...265)V AC - (140...370)V DC	A	1.5	3
Max. output current (battery charge limitation)	A	1.9	3.3
Rated voltage	V	24	12
Rated power	W	36	36
Output power (-20...+40 °C, 230 V AC input)	W	40	40
Peak current capability for 3 ms*	A	6	12
Output voltage adjust	V	24 - 28	12 - 16
Voltage variation (from no-load to full-load)		< 1%	< 1%
Voltage ripple @ full load	mV	< 200	< 200
Hold-up time @ full load:	with 110 V AC input ms	> 20	> 30
	with 250 V AC input ms	> 100	> 150

Input specification

Nominal voltage (U_N)	V AC (50/60 Hz)	110...240	110...240
	V DC (not polarized)	220	220
Operating range	V AC (50/60 Hz)	100...260	100...260
	V DC	140...370	140...370
Max power consumption	VA	67	67.5
	W (@ 110 V AC, 50 Hz)	41	42
Stand-by power consumption (@ 230 V AC)	W	≤ 0.4	≤ 0.3
Power factor		0.62	0.61
Max current consumption (@ 100 V AC)	A	0.6	0.65
Max. inrush current (peak @ 250 V AC) for 3 ms	A	10	10

Technical data

Efficiency (@ 230 V AC)	%	90	90
MTTF	h	> 600 · 10 ³	> 600 · 10 ³
Start-up delay	s	< 3	< 3
Dielectric strength between input/output	V AC	3000	3000
Ambient temperature range**	°C	-20...+70	-20...+70
Protection category		IP 20	IP 20

Approvals (according to type)

78.36 - 2402



- 24 V DC, 36 W output
- Output adjustable between 24-28 V
- SELV
- Suitable for battery charging

78.36 - 1202

- 12 V DC, 36 W output
- Output adjustable between 12-16 V
- SELV
- Suitable for battery charging

* (see diagrams P78)

** (see derating diagrams L78)

 suitable for battery charging (see details page 28)

50 W or 60 W High efficiency, low profile Modular DC Power Supplies for electrical cabinets

Type 78.50

- Output 12 V DC, 50 W
- Designed for SELV system (EN 60950)
- Suitable for backup battery systems

Type 78.60

- Output 24 V DC, 60 W
- Designed for SELV system (EN 60950)
- Suitable for backup battery systems

- High efficiency (up to 91%)
- Low stand-by power consumption
- Thermal protection: internal, with V_{out} shutdown - power OFF to reset
- Short circuit protection: Hiccup (auto-recovery) mode
- Overvoltage protection: Varistor
- Flyback topology
- ZVS (Zero-voltage-switching), quasi-resonant mode switching
- Compliant with EN 60950-1 and EN 61204-3
- Parallel working for automatic redundancy - with OR diodes
- Dual Polarity and Series connection permissible
- Compact dimensions: 70 mm (4-modules) wide, 61 mm deep
- 35 mm rail (EN 60715) mount

78.50/78.60
Box clamp



For outline drawing see page 37

78.50

- 12 V DC, 50 W output
- Output adjustable between 12-16 V
- ZVS technology
- SELV

78.60

- 24 V DC, 60 W output
- Output adjustable between 24-28 V
- SELV
- Suitable for battery charging
- ZVS technology

* (see diagrams P78)
 ** peak to peak, 100 Hz component, with 100 V AC input
 *** 88...100 V AC with output current limited to 80% I_N
 **** (see derating diagrams L78)
 suitable for battery charging (see details page 28)

Output specification

Output current (-20...+40 °C, 230 V AC input)	A	4.6	2.8
Rated current I_N			
50 °C, input (100...265)V AC - (140...370)V DC	A	4.2	2.5
Rated voltage	V	12	24
Rated power	W	50	60
Output power (-20...+40 °C, 230 V AC input)	W	55	68
Peak current capability for 3 ms*	A	12	10
Output voltage adjust	V	12...16	24...28
Voltage variation (from no-load to full-load)		< 1%	< 1%
Voltage ripple @ full load**	mV	< 200	< 200
Hold-up time @ full load: with 100 V AC input ms		> 30	> 20
with 260 V AC input ms		> 150	> 130

Input specification

Nominal voltage (U_N)	V AC (50/60 Hz)	110...240	110...240
	V DC (not polarized)	220	220
Operating range	V AC (50/60 Hz)	88...265***	88...265***
	V DC	140...370	140...370
Max power consumption (@ 110 V AC, 50 Hz)	VA	86	105
	W	57	68
Stand-by power consumption (@ 230 V AC)	W	< 0.3	< 0.45
Power factor		0.65	0.65
Max current consumption (@ 88 V AC)	A	0.7	0.9
Max. inrush current (peak @ 265 V AC) for 3 ms	A	30	30
Input fuse		1.6 A - T	1.6 A - T

Technical data

Efficiency (@ 230 V AC)	%	90	91
MTTF	h	> 400 · 10 ³	> 500 · 10 ³
Start-up delay	s	< 1	< 1
Dielectric strength between input/output	V AC	3000	3000
Ambient temperature range****	°C	-20...+70	-20...+70
Protection category		IP 20	IP 20

Approvals (according to type)



Industrial Single phase Switch Mode DC Power Supplies: 75 W and 120 W
Type 78.J1

- Output 24 V DC, 75 W

Type 78.W1

- Output 24 V DC, 120 W

- High efficiency (up to 92%)
- Low stand-by power consumption (down to 1 W)
- DC output voltage adjustable
- Short circuit protection with hiccup auto-recovery
- Thermal protection with auto shutdown
- High peak current up to 30%
- Boost current up to 30% for 3 s (depending on version)
- Overvoltage protection: Varistor
- Compliant with IEC/EN 62368-1, UL 61010
- Parallel working for increased load current (with external diode) or redundancy
- 35 mm rail (EN 60715) mount

78.J1/78.W1

Box clamp



F

For outline drawing see page 40

NEW 78.J1.1.230.2402

- 24 V DC, 75 W output
- Output adjustable between 24-28 V
- Compact size, low standby consumption

NEW 78.W1.1.230.2402

- 24 V DC, 120 W output
- Output adjustable between 24-28 V
- Compact size, low standby consumption

* (see derating diagrams L78)

* (see derating diagrams L78)

Output specification

Output current (-20...+50 °C, 230 V AC input)	A	3.2	5
Rated voltage	V	24	24
Rated power	W	77	120
Peak current capability for 5 ms	A	4.16	6.5
Output voltage adjust	V DC	24...28	24...28
Voltage variation (from no-load to full-load)		< 2%	< 2%
Voltage ripple @ full load	mV	120	120
Hold-up time @ full load:	with 115 V AC input ms	12	10
	with 230 V AC input ms	60	16

Input specification

Nominal voltage (U _N)	V AC (50/60 Hz)	100...240	100...240
	V DC	140...338	140...338
Operating range	V AC (50/60 Hz)	90...264	90...264
	V DC	127...370	127...370
Drop out DC Voltage	V DC	127	127
Max power consumption	VA	142	195
	W (@ minimum V AC operating range)	114.2	177
Stand-by power consumption	W	0.7	0.7
Power factor		≥ 0.62	≥ 0.70
Max current consumption (@ 230 V AC)	A	0.9	1.3
Max. inrush current (peak @ 230 V AC)	A	35	35

Technical data

Efficiency (@ 230 V AC)	%	87.5	88
MTTF	h	> 450 · 10 ³	> 450 · 10 ³
Start-up delay (@ 230 V AC-full load)	ms	1200	1200
Dielectric strength between input/output	V AC	3000	3000
Dielectric strength between input/PE	V AC	2000	2000
Ambient temperature range*	°C	-20...+70	-20...+70
Protection category		II	III

Approvals (according to type)

Industrial Single phase Switch Mode DC Power Supplies: 240 W and 480 W

Type 78.X1

- Output 24 V DC, 240 W

Type 78.Y1

- Output 24 V DC, 480 W

- High efficiency (up to 92%)
- Low stand-by power consumption
- Active PFC
- DC output voltage adjustable
- Short circuit protection with hiccup auto-recovery
- Thermal protection with auto shutdown
- High peak current up to 30%
- Boost current up to 30% for 3 s (depending on version)
- Overvoltage protection: Varistor
- Compliant with IEC/EN 62368-1, UL 61010
- Parallel working for increased load current (with external diode) or redundancy
- 35 mm rail (EN 60715) mount

78.X1/78.Y1
Box clamp



For outline drawing see page 40, 41

Output specification

Output current (-20...+50 °C, 230 V AC input)	A	10	20
Rated voltage	V	24	24
Rated power	W	240	480
Current boost for 3 s	A	—	26
Peak current capability for 5 ms	A	13	26
Output voltage adjust	V DC	24...28	24...28
Voltage variation (from no-load to full-load)		< 2%	< 2%
Voltage ripple @ full load	mV	150	150
Hold-up time @ full load:	with 115 V AC input	12	16
	with 230 V AC input	16	16

Input specification

Nominal voltage (U _N)	V AC (50/60 Hz)	100...240	100...240
	V DC	140...338	140...338
Operating range	V AC (50/60 Hz)	90...264	90...264
	V DC	127...370	127...370
Drop out DC Voltage	V DC	127	127
Max power consumption	VA	336	579.7
	W (@ minimum V AC operating range)	358.6	678
Stand-by power consumption	W	5.0	6.0
Power factor		≥ 0.82	≥ 0.90
Max current consumption (@ 230 V AC)	A	1.3	2.4
Max. inrush current (peak @ 230 V AC)	A	35	35

Technical data

Efficiency (@ 230 V AC)	%	87	92
MTTF	h	> 200 · 10 ³	> 150 · 10 ³
Start-up delay (@ 230 V AC-full load)	ms	1500	1500
Dielectric strength between input/output	V AC	3000	3000
Dielectric strength between input/PE	V AC	2000	2000
Ambient temperature range*	°C	-20...+70	-20...+70
Protection category		III	III

Approvals (according to type)



NEW 78.X1.1.230.2412



- 24 V DC, 240 W output
- Output adjustable between 24-28 V
- Double stage with active PFC (Power Factor Correction)

NEW 78.Y1.1.230.2412



- 24 V DC, 480 W output
- Output adjustable between 24-28 V
- Double stage with active PFC (Power Factor Correction)

* (see derating diagrams L78)

* (see derating diagrams L78)

**Industrial Switch Mode DC Power Supplies:
120 W to 240 W**
Type 78.1A

- Output 24 V DC, 120 W
- High efficiency (up to 92%)

Type 78.2A
High efficiency PSU with high peak output current and low stand by power consumption

- Output 24 V DC, 240 W
- High efficiency (up to 94%)
- LLC topology
- Thermal protection internal, power OFF to reset
- Boost current: Without time limit
- Low stand-by power consumption (< 1 W)
- Short circuit protection: Hiccup (auto-recovery) mode
- Overvoltage protection: Varistor
- Compliant with EN 60950-1 and EN 61204-3
- Parallel working for increased load current (with OR diodes)
- Dual Polarity and Series connection permissible
- 35 mm rail (EN 60715) mount

 78.1A/78.2A
Box clamp

F

For outline drawing see page 39

Output specification

Output current (-20...+40 °C, 230 V AC input)	A	6.0 (@ 40 °C)	11 (@ 30°C) / 10 (@ 40°C)
Output current (-20...+40 °C, 120 V AC input)	A	4.5 (@ 40 °C)	9
Rated voltage	V	24	24
Rated power	W	120 (@ 40°C)	240 (@ 40°C)
Max. output power (-20...+40 °C, 230 V AC input)	W	140 (@ 40°C)	260 (@ 30°C)
Peak current capability for 5 ms*	A	10	25
Output voltage adjust	V DC	24...28	24...28
Voltage variation (from no-load to full-load)		< 2%	< 3%
Voltage ripple @ full load**	mV	< 500	< 300
Hold-up time @ full load:	with 120 V AC input	> 25	> 30
	with 250 V AC input	> 110	> 50

Input specification

Nominal voltage (U _N)	V AC (50/60 Hz)	120...240	120 or 230
Operating range	V AC (50/60 Hz)	120...260	95...130 or 185...260
Max power consumption	VA	195 (@ 50 Hz)	361 (@ 50 Hz)
	W	134 (@ 50 Hz)	265 (@ 50 Hz)
Stand-by power consumption (@ 230 V AC)	W	< 1.9	≤ 3 @ 120 V ; ≤ 2.6 W @ 230 V
Power factor		0.69	0.73
Max current consumption	A	1.75 (@ 120 V AC)	3.5 (@ 100 V AC)
Max. inrush current (peak @ 265 V AC) for 3 ms	A	14	14

Technical data

Efficiency (@ 230 V AC)	%	92	94
MTTF	h	> 500 · 10 ³	> 400 · 10 ³
Start-up delay	s	< 3	< 1
Dielectric strength between input/output	V AC	2000	2000
Ambient temperature range***	°C	-20...+60	-20...+60
Protection category		IP 20	IP 20

Approvals (according to type)

78.1A

- 24 V DC, 120 W output
- Output adjustable between 24-28 V

78.2A

- 24 V DC, 240 W output
- Output adjustable between 24-28 V
- Suggested for PLC power supply

* (see diagrams P78)

** peak to peak, 100 Hz component, with 120 V AC input (78.1A) and 100 V AC input (78.2A)

*** (see derating diagrams L78)

 suitable for battery charging (see details page 28) (78.2A)

**Industrial Switch Mode DC Power Supplies:
120 W to 130 W**

Type 78.1B

- Output 24 V DC, 120 W, compact size
- Secure electrical separation (SELV according to EN 60950)

Type 78.1D

- Output 24 V DC, 130 W
- Double stage active Power Factor Correction
- Fold-Back overload characteristics for Battery charging applications and parallel working for increased load current (78.1D)
- High efficiency (up to 93%)
- Low stand-by power consumption (down to 1 W)
- LLC (78.1B) or forward topology (78.1D)
- Thermal protection: internal with pre-alert alarm via LED and auxiliary contact, and with V_{out} safety shutdown - power OFF to reset (78.1D)
- Overload indication: Pre-alert alarm via LED and auxiliary contact indication (78.1D)
- Boost current: Without time limit, with LED and auxiliary contact indication (78.1D)
- Overload protection: Fold-back mode (78.1D)
- Short circuit protection: Hiccup (auto-recovery) mode
- Input fuse: Easily replaceable plus spare
- Overvoltage protection: Varistor
- Compliant with EN 60950-1 and EN 61204-3
- Parallel working for increased load current (with OR diodes)
- Dual Polarity and Series connection permissible
- 35 mm rail (EN 60715) mount

For outline drawing see page 37, 38

Output specification

Output current (-20...+50 °C, 230 V AC input)	A	5.0 (@ 40 °C)	5.4 (@ 50 °C)
Output current (-20...+50 °C, 120 V AC input)	A	4.5 (@ 40 °C)	5.4 (@ 50 °C)
Rated voltage	V	24	24
Rated power	W	120 (@ 40°C)	130 (@ 50°C)
Max. output power (-20...+40 °C, 230 V AC input)	W	120	130
Peak current capability for 5 ms*	A	10	10
Output voltage adjust	V DC	24...28	24...28
Voltage variation (from no-load to full-load)		< 3%	< 1%
Voltage ripple @ full load**	mV	< 300	< 100
Hold-up time @ full load: with 120 V AC input	ms	> 20	> 20
with 250 V AC input	ms	> 90	> 20

Input specification

Nominal voltage (U_N)	V AC (50/60 Hz)	120...240	110...240
	V DC	220	110...240
Operating range	V AC (50/60 Hz)	100...265	88...265
	V DC	140...275 (polarized)	95...275 (non-polarized)
Drop out DC Voltage	V	110	80
Max power consumption	VA	268 (@ 50 Hz)	145 (@ 50 Hz)
	W	133 (@ 50 Hz)	145 (@ 50 Hz)
Stand-by power consumption (@ 230 V AC)	W	< 1.0	< 3.3
Power factor		0.5	0.998
Max current consumption	A	1.75 (@ 115 V AC)	1.6 (@ 88 V AC)
Max. inrush current (peak @ 250 V AC) for 3 ms	A	12	12
Replaceable input fuse		3.15 A - T	2.5 A - T

Technical data

Efficiency (@ 230 V AC)	%	93	89
MTTF	h	> 500 · 10 ³	> 400 · 10 ³
Start-up delay	s	< 1	< 1
Dielectric strength between input/output	V AC	2500 (SELV)	2500
Dielectric strength between input/PE	V AC	1500	1500
Ambient temperature range***	°C	-20...+70	-20...+70
Protection category		IP 20	IP 20

Approvals (according to type)



78.1B



- 24 V DC, 120 W output
- Output adjustable between 24-28 V
- Compact size, low stand-by consumption

78.1D



- 24 V DC, 130 W output
- Output adjustable between 24-28 V
- Double stage with active PFC (Power Factor Correction)

Replaceable fuse + spare



Thermal protection with LED indication



Auxiliary contact signalling



(depending on type)

* (see diagrams P78)

** peak to peak, 100 Hz component, with 120 V AC input

*** (see derating diagrams L78)

suitable for battery charging (see details page 28) (78.1D)

**Industrial Switch Mode DC Power Supply:
240 W****Overload characteristics support parallel
working for increased load current****Type 78.2E**

- Output 24 V DC, 240 W
- Double stage active Power Factor Correction

- High efficiency (up to 93%)
- Low stand-by power consumption
- Forward topology
- Thermal protection: internal with pre-alert alarm via LED and auxiliary contact, and with V_{out} safety shutdown - power OFF to reset
- Overload indication: Pre-alert alarm via LED and auxiliary contact indication
- Boost current: Without time limit, with LED and auxiliary contact indication
- Overload up to 20 A
- Short circuit protection: Hiccup (auto-recovery) mode
- Input fuse: Easily replaceable plus spare
- Overvoltage protection: Varistor
- Compliant with EN 60950-1 and 61204-3
- Parallel working for increased load current (with OR diodes)
- Dual Polarity and Series connection permissible
- 35 mm rail (EN 60715) mount

78.2E
Box clamp

For outline drawing see page 38

Output specification

Output current (-20...+40 °C, 230 V AC input)	A	10.8
Rated current I_N (50 °C, full input operating range)	A	10
Rated voltage	V	24
Rated power	W	240
Output power (-20...+40 °C, 230 V AC input)	W	250
Peak current capability for 5 ms*	A	25
Output voltage adjust	V DC	24...28
Voltage variation (from no-load to full-load)		< 1%
Voltage ripple @ full load**	mV	< 100
Hold-up time @ full load: with 110 V AC input	ms	> 20
with 260 V AC input	ms	> 20

Input specification

Nominal voltage (U_N)	V AC (50/60 Hz)	110...240
	V DC	110...240
Operating range	V AC (50/60 Hz)	88...265
	V DC	90...275 (non-polarised)
Drop out DC Voltage	V	80
Max power consumption (@ minimum V AC operating range)	VA	275 (@ 50 Hz)
	W	274 (@ 50 Hz)
Stand-by power consumption (@ 88 V)	W	≤ 2.8
Power factor		0.995
Max current consumption	A	3.0 (@ 88 V AC)
Max. inrush current (peak @ 265 V AC) for 3 ms	A	12
Replaceable input fuse		3.15 A - T

Technical data

Efficiency (@ 230 V AC)	%	93
MTTF	h	> 400 · 10 ³
Start-up delay	s	< 1
Dielectric strength between input/output	V AC	2500
Dielectric strength between input/PE	V AC	1500
Ambient temperature range***	°C	-20...+70
Protection category		IP 20

Approvals (according to type)**78.2E**

- 24 V DC, 240 W output
- Output adjustable between 24-28 V
- Double stage with active PFC (Power Factor Correction)

Replaceable fuse
+ spareThermal protection
with LED indicationAuxiliary contact
signalling

* (see diagrams P78)

** peak to peak, 100 Hz component, with 110 V AC input

*** (see derating diagrams L78)

Industrial Dual phase wide input range Switch Mode DC Power Supplies: 60 W and 120 W

Type 78.H2

- Output 24 V DC, 60 W

Type 78.W2

- Output 24 V DC, 120 W

- Single and 2 phases wide input range
- High efficiency (up to 91%)
- Auxiliary contact: DC OK
- Low stand-by power consumption
- DC output voltage adjustable
- Short circuit protection with hiccup auto-recovery
- Thermal protection with auto shutdown
- High peak current up to 30%
- Boost current up to 30% for 3 s (depending on version)
- Overvoltage protection: Varistor
- Compliant with EN 61010-1, UL 61010
- Parallel working for increased load current (with external diode) or redundancy
- 35 mm rail (EN 60715) mount

78.H2/78.W2
Box clamp



For outline drawing see page 41

Output specification

Output current (-20...+50 °C, 230 V AC input)	A	2.5	5
Rated voltage	V	24	24
Rated power	W	60	120
Peak current capability for 5 ms	A	3.3	6.5
Output voltage adjust	V DC	24...28	24...28
Voltage variation (from no-load to full-load)		< 2%	< 2%
Voltage ripple @ full load	mV	150	120
Hold-up time @ full load:	with 400 V AC input ms	20	50
	with 230 V AC input ms	10	10

Input specification

Nominal voltage (U _N)	V AC (50/60 Hz)	200...480	200...500
	V DC	282...677	282...705
Operating range	V AC (50/60 Hz)	180...550	180...550
	V DC	254...780	254...780
Drop out DC Voltage	V DC	254	254
Max power consumption	VA	108.7	203
	W (@ minimum V AC operating range)	87.6	171
Stand-by power consumption	W	1.0	3.0
Power factor		≥ 0.62	≥ 0.65
Max current consumption (@ 230 V AC)	A	0.7	1.2
Max. inrush current (peak @ 400 V AC)	A	50	50

Technical data

Efficiency (@ 400 V AC)	%	89	91
MTTF	h	> 1600 · 10 ³ or > 160 · 10 ⁴	> 1300 · 10 ³ or > 130 · 10 ⁴
Start-up delay (@ 230 V AC-full load)	ms	2000	2000
Dielectric strength between input/output	V AC	3000	3000
Dielectric strength between input/PE	V AC	2000	2000
Ambient temperature range*	°C	-30...+85	-25...+70
Protection category		III	III

Approvals (according to type)

NEW 78.H2.1.440.2404



- 24 V DC, 60 W output
- Wide input range
- Auxiliary feedback contact: DC OK
- Output adjustable between 24-28 V

* (see derating diagrams L78)

NEW 78.W2.1.440.2404



- 24 V DC, 120 W output
- Wide input range
- Auxiliary feedback contact: DC OK
- Output adjustable between 24-28 V

* (see derating diagrams L78)



Industrial Dual phase wide input range Switch Mode DC Power Supplies: 240 W and 480 W
Type 78.X2

- Output 24 V DC, 240 W

Type 78.Y2

- Output 24 V DC, 480 W

- Single and 2 phases wide input range
- High efficiency (up to 91%)
- Auxiliary contact: DC OK
- Constant current output limiting circuit
- Active PFC
- Low stand-by power consumption
- DC output voltage adjustable
- Short circuit protection with hiccup auto-recovery
- Thermal protection with auto shutdown
- High peak current up to 30%
- Boost current up to 30% for 3 s (depending on version)
- Overvoltage protection: Varistor
- Compliant with EN 61010-1, UL 61010
- Parallel working for increased load current (with external diode) or redundancy
- 35 mm rail (EN 60715) mount

 78.X2/78.Y2
Box clamp

For outline drawing see page 42

NEW 78.X2.1.440.2414

- 24 V DC, 240 W output
- Wide input range
- Output adjustable between 24-28 V
- Auxiliary feedback contact: DC OK
- Double stage with active PFC (Power Factor Correction)

* (see derating diagrams L78)

NEW 78.Y2.1.440.2414

- 24 V DC, 480 W output
- Wide input range
- Output adjustable between 24-28 V
- Auxiliary feedback contact: DC OK
- Double stage with active PFC (Power Factor Correction)

* (see derating diagrams L78)

Output specification

Output current (-20...+50 °C, 230 V AC input)	A	10	20
Rated voltage	V	24	24
Rated power	W	240	480
Current boost for 3 s	A	13	26
Peak current capability for 5 ms	A	13	26
Output voltage adjust	V DC	24...28	24...28
Voltage variation (from no-load to full-load)		< 2%	< 2%
Voltage ripple @ full load	mV	150	100
Hold-up time @ full load:	with 400 V AC input ms	18	18
	with 230 V AC input ms	18	16

Input specification

Nominal voltage (U _N)	V AC (50/60 Hz)	220...500	200...500
	V DC	311...705	282...705
Operating range	V AC (50/60 Hz)	180...550	180...550
	V DC	254...780	254...780
Drop out DC Voltage	V DC	254	254
Max power consumption	VA	314	627.9
	W (@ minimum V AC operating range)	342.8	685
Stand-by power consumption	W	5	5
Power factor		≥ 0.84	≥ 0.84
Max current consumption (@ 230 V AC)	A	2	4
Max. inrush current (peak @ 400 V AC)	A	50	50

Technical data

Efficiency (@ 230 V AC)	%	91	91
MTTF	h	> 900 · 10 ³	> 700 · 10 ³
Start-up delay (@ 230 V AC-full load)	ms	1500	2000
Dielectric strength between input/output	V AC	3000	3000
Dielectric strength between input/PE	V AC	2000	2000
Ambient temperature range*	°C	-30...+70	-30...+70
Protection category		III	III

Approvals (according to type)

**Industrial Three phase wide input range
Switch Mode DC Power Supplies: 240 W to 960 W**

Type 78.X3

- Output 24 V DC, 240 W

Type 78.Y3

- Output 24 V DC, 480 W

Type 78.Z3

- Output 24 V DC, 960 W
- Current sharing possibility up to 3840 W:
4 power supply

- Three phases wide input range
- High efficiency (up to 92%)
- Dual phase functioning possible
- Auxiliary contact: DC OK
- Constant current output limiting circuit
- Active PFC
- Low stand-by power consumption
- DC output voltage adjustable
- Short circuit protection with hiccup auto-recovery
- Thermal protection with auto shutdown
- High peak current up to 30%
- Boost current up to 30% for 3 s
- Overvoltage protection: Varistor
- Compliant with EN 61010-1, UL 61010
- Parallel working for increased load current
(with external diode) or redundancy
- 35 mm rail (EN 60715) mount

For outline drawing see page 42, 43

Output specification

Output current (-20...+50 °C, 400 V AC input)	A	10 (@ 60°)
Rated voltage	V	24
Rated power	W	240
Current boost for 3 s	A	13
Peak current capability for 5 ms	A	13
Output voltage adjust	V DC	24...28
Voltage variation (from no-load to full-load)		< 1%
Voltage ripple @ full load	mV	100
Hold-up time @ full load:	with 400 V AC input ms	20
	with 500 V AC input ms	40

Input specification

Nominal voltage (U _N)	V AC (50/60 Hz)	380...480
	V DC	500...780
Operating range	V AC (50/60 Hz)	340...550
	V DC	480...780
Drop out DC Voltage	V DC	480
Max power consumption	VA	501.6
	W (@ minimum V AC operating range)	339
Stand-by power consumption	W	8.0
Power factor		≥ 0.52
Max current consumption (@ 400 V AC)	A	0.69
Max. inrush current (peak @ 400 V AC)	A	50

Technical data

Efficiency (@ 400 V AC)	%	92
MTTF	h	> 1500 · 10 ³ or > 150 · 10 ⁴
Start-up delay (@ 400 V AC-full load)	ms	2000
Dielectric strength between input/output	V AC	3000
Dielectric strength between input/PE	V AC	2000
Ambient temperature range*	°C	-30...+70
Protection category		III

Approvals (according to type)



NEW 78.X3.1.440.2414



- 24 V DC, 240 W output
- Wide input range
- Output adjustable between 24-28 V
- Auxiliary feedback contact: DC OK
- Double stage with active PFC (Power Factor Correction)

* (see derating diagrams L78)

NEW 78.Y3.1.440.2414



- 24 V DC, 480 W output
- Wide input range
- Output adjustable between 24-28 V
- Auxiliary feedback contact: DC OK
- Double stage with active PFC (Power Factor Correction)

* (see derating diagrams L78)

NEW 78.Z3.1.440.2414



- 24 V DC, 960 W output
- Wide input range
- Output adjustable between 24-28 V
- Auxiliary feedback contact: DC OK
- Double stage with active PFC (Power Factor Correction)
- Directly parallelable thanks to the internal clock

* (see derating diagrams L78)

Ordering information

Example: 78 series switch mode power supply, 36 W - 24 V DC output, supply voltage 110...240 V AC, embedded fuse and output voltage regulator.

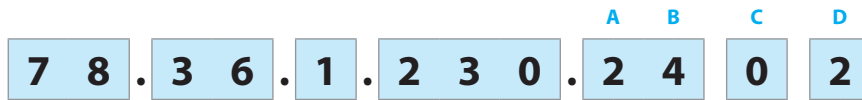

Series

Power

- 12 = 12 W output
- 25 = 25 W output
- 36 = 36 W output
- 50 = 50 W output
- 60 = 60 W output
- 1A = 120 W output
- 2A = 240 W output
- 1B = 120 W output
- 1D = 130 W output
- 2E = 240 W output

Voltage conversion

- 1 = AC/DC input, DC output
- 1 = AC input, DC output (78.1A, 78.2A)

Input voltage

- 230 = 110...240 V AC / 220 V DC
- 230 = 110...240 V AC/DC
- 230 = 120...240 V AC / 220 V DC
- 230 = 120 or 230 V AC adjustable (78.2A)

D:

- 0 = Standard
- 2 = Embedded fuse + output voltage regulator (without voltage regulator for 78.12)
- 3 = Replaceable fuse + output voltage regulator
- 4 = Fuse + regulator + positive logic contact
- 5 = Fuse + regulator + pre-alarm contact

C:

- 0 = Standard
- 1 = Double stage, with PFC (Power Factor Correction)
- 8 = Power supply for OPTA PLR, 8A series

AB:

- 12 = 12 V DC output
- 24 = 24 V DC output

Codes

- 78.12.1.230.1200
- 78.12.1.230.2400
- 78.12.1.230.1202
- 78.12.1.230.2402
- 78.12.1.230.2482 (OPTA)
- 78.25.1.230.1202
- 78.25.1.230.2400
- 78.25.1.230.2482 (OPTA)
- 78.36.1.230.1202
- 78.36.1.230.2402
- 78.50.1.230.1202
- 78.60.1.230.2402
- 78.1A.1.230.2402
- 78.2A.1.230.2402
- 78.1B.1.230.2403
- 78.1D.1.230.2414
- 78.1D.1.230.2415
- 78.2E.1.230.2414
- 78.2E.1.230.2415

Ordering information

Example: 78 series switch mode power supply, 120 W - 24 V DC output, supply voltage 100...240 V AC, embedded fuse and output voltage regulator.

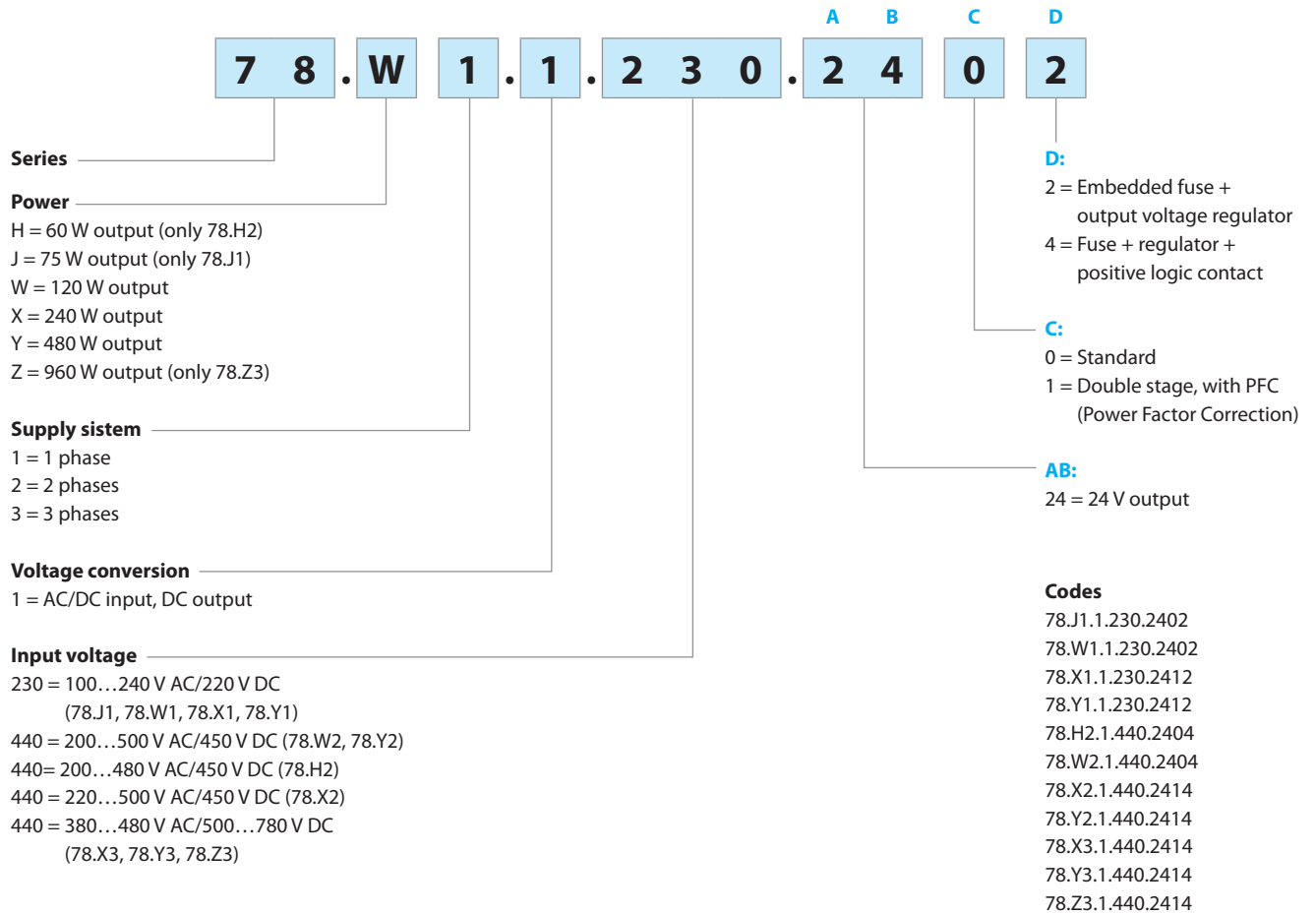

Technical data

EMC specifications (according to EN 61204-3)		Reference standard	78.12 78.36 78.25... 2400	78.50, 78.60	78.1A	78.1B	78.1D	78.2A	78.2E	78.25... 1202/ 2482
Electrostatic discharge	contact discharge	EN 61000-4-2	4 kV	4 kV	4 kV	4 kV	4 kV	4 kV	4 kV	4 kV
	air discharge	EN 61000-4-2	8 kV	8 kV	8 kV	8 kV	8 kV	8 kV	8 kV	8 kV
Radiated electromagnetic field	80...1000 MHz	EN 61000-4-3	6 V/m	10 V/m	10 V/m	10 V/m	10 V/m	10 V/m	10 V/m	10 V/m
	1...2.8 GHz	EN 61000-4-3	3 V/m	3 V/m	3 V/m	3 V/m	3 V/m	10 V/m	10 V/m	5 V/m
Fast transients (burst 5/50 ns, 5 and 100 kHz)	on supply terminals	EN 61000-4-4	2 kV	3 kV	2 kV	2 kV	3 kV	3 kV	3 kV	2 kV
Voltage pulses on supply terminals (surge 1.2/50 µs)	common mode	EN 61000-4-5	—	—	2 kV	2 kV	3 kV	2.5 kV	2.5 kV	—
	differential mode	EN 61000-4-5	1 kV	1 kV	4 kV *	4 kV *	4 kV*	4 kV	4 kV*	1 kV
Radio-frequency common mode voltage (0.15...230 MHz)	on supply terminals	EN 61000-4-6	6 V	10 V	10 V	10 V	10 V	10 V	10 V	10 V
Short interruptions		EN 61000-4-11	5 cycles	6 cycles	5 cycles	5 cycles	6 cycles	5 cycles	5 cycles	5 cycles
Radio-frequency conducted emissions	0.15...30 MHz	EN 55022	class B	class B	class A	class B	class B	class A	class B	class B
Radiated emissions	30...1000 MHz	EN 55022	class B	class B	class A	class A	class A	class A	class A	class B
Terminals			Max			Min...Max				
Wire size (Solid cable, stranded cable)	mm ²		1 x 4 / 2 x 2.5			1 x 0.5...1 x 4				
	AWG		1 x 12 / 2 x 14			1 x 20...1 x 12				
Wire size (Solid cable, stranded cable for 78.50, 78.60, 78.1A and 78.2A)	mm ²		1 x 2.5			1 x 0.5...2.5				
	AWG		1 x 14			1 x 20...14				
Screw torque	Nm		0.8			0.5				
	Lb-in		7.1			7.1				
Wire strip length	mm		8			8				
Other data										
Power lost to the environment with rated output current	W		2 (78.12), 2.3 (78.25), 3.6 (78.36, 78.50), 5.4 (78.60)							
	W		10 (78.1A), 9 (78.1B), 13.2 (78.1D), 15.3 (78.2A), 16.8 (78.2E)							

* Input fuse may blow for surges higher than 2 kV

Output specification

L78-1 Output current v ambient temperature (78.12-1200/2400)

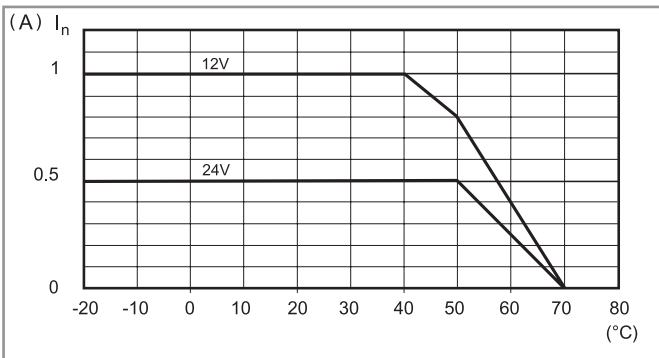

P78-1 Output peak current v time (78.12-xxxx)

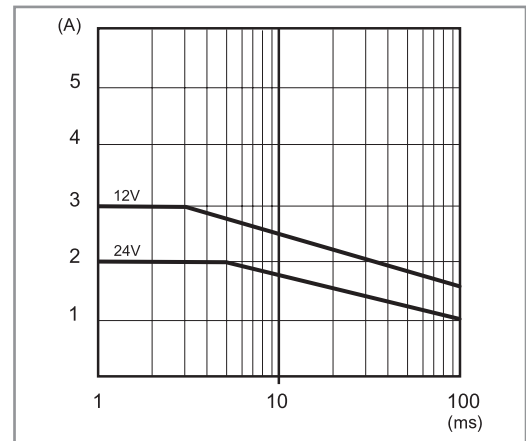

L78-2 Output current v ambient temperature (78.12-1202/2402)

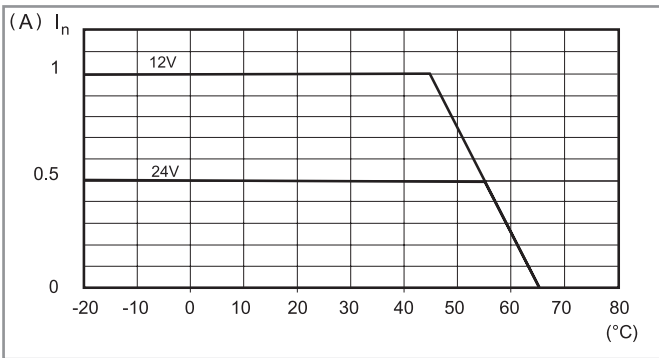

P78-2 Output peak current v time (78.12-xxxx)

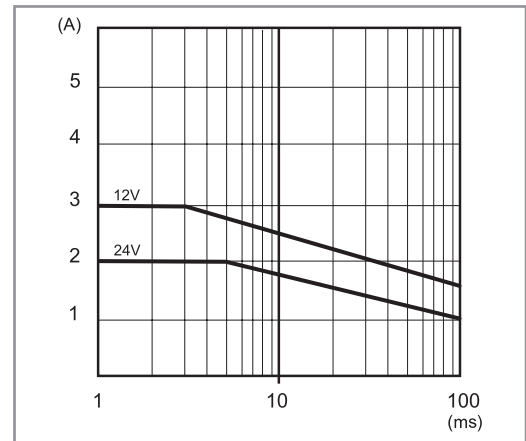

L78-3 Output current v ambient temperature (78.25)

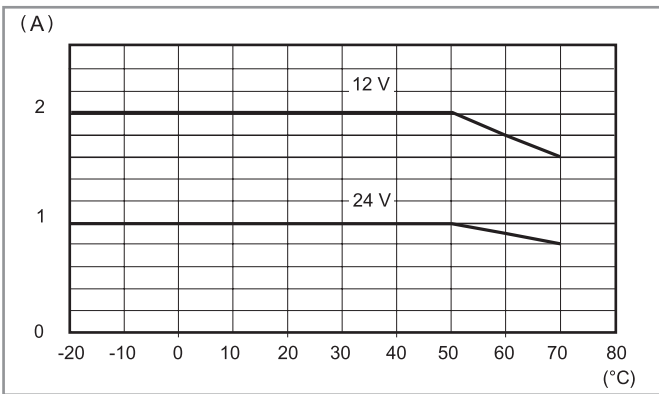

P78-3 Output peak current v time (78.25)

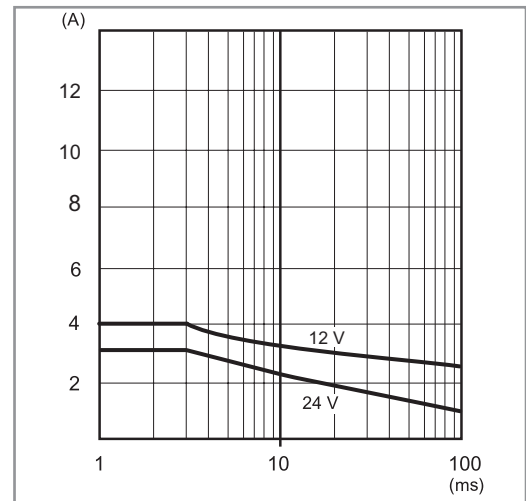

F

Output specification

L78-4 Output current v ambient temperature (78.36) - 12 - 24 V

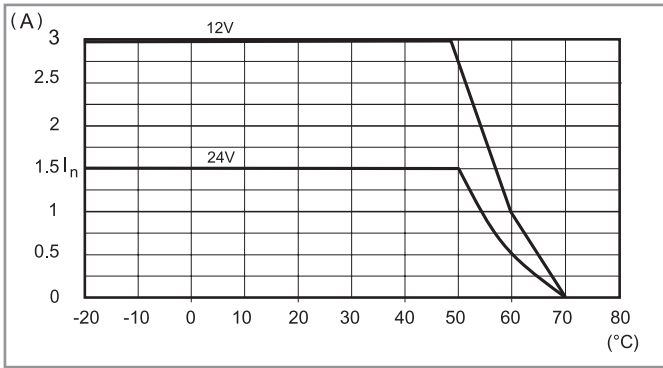

P78-4 Output peak current v time (78.36) - 12 - 24 V

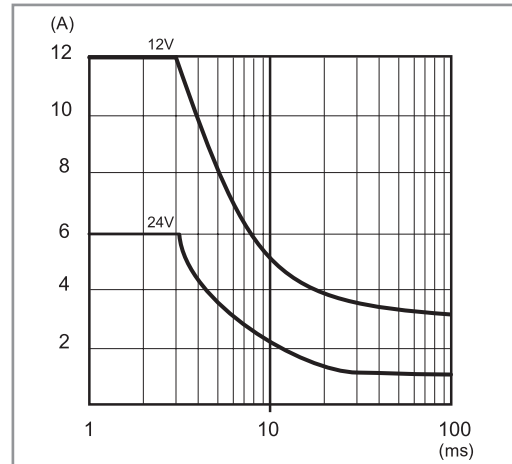

L78-5 Output current v ambient temperature (78.60)

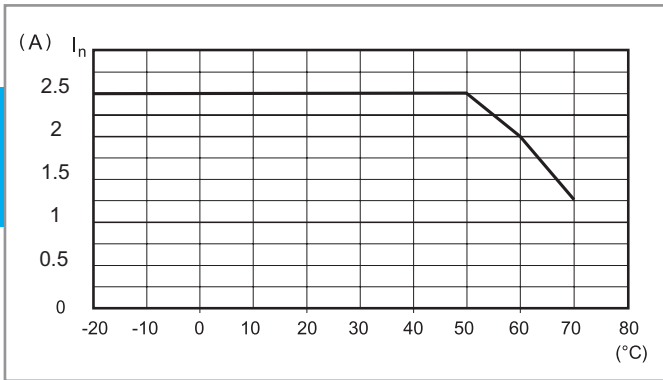

P78-5 Output peak current v time (78.60)

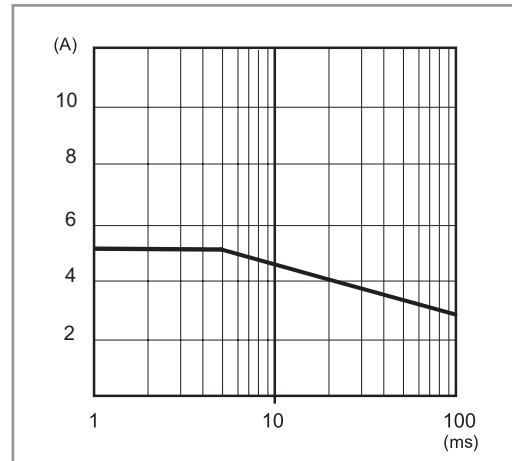

L78-6 Output current v ambient temperature (78.50)

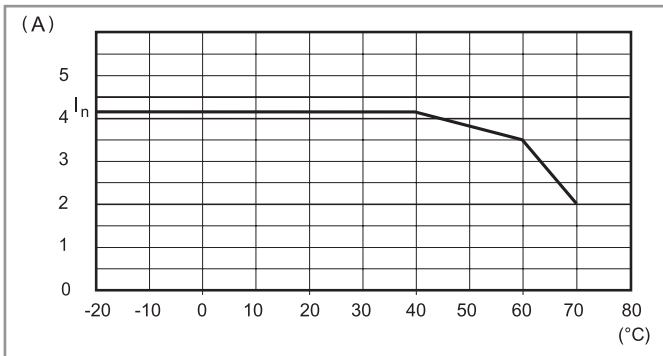

P78-6 Output peak current v time (78.50)

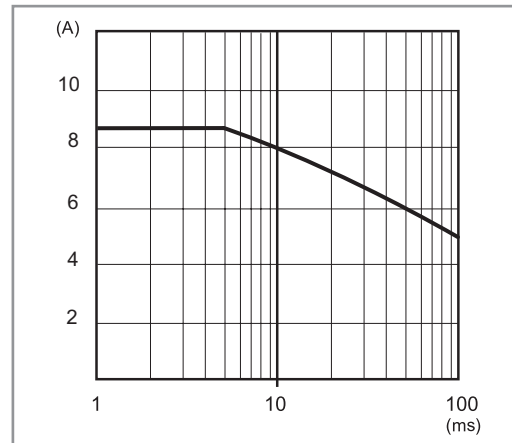

F

Output specification

L78-7 Output current v ambient temperature (78.1A)

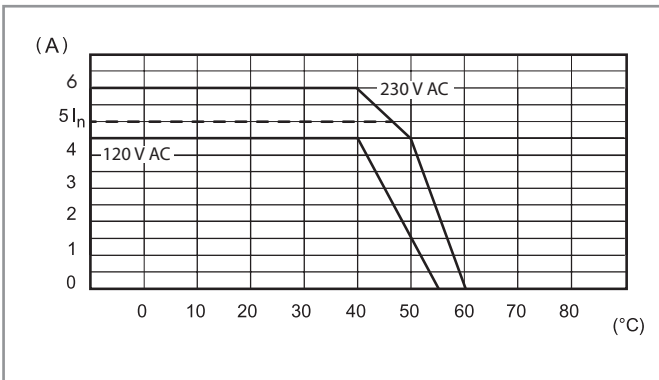

P78-7 Output peak current v time (78.1A)

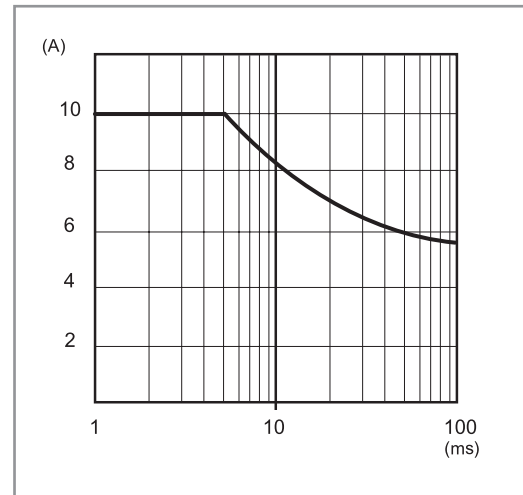

L78-8 Output current v ambient temperature (78.1B)

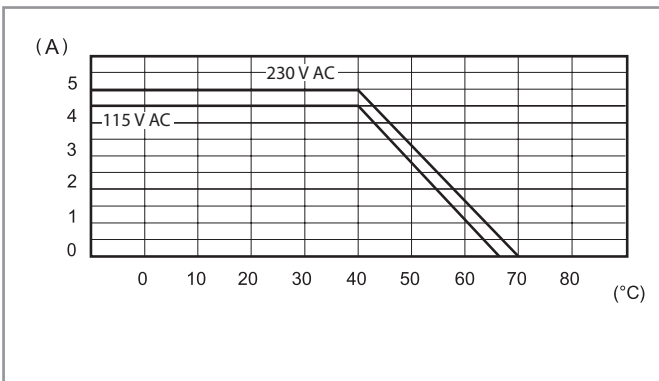

P78-8 Output peak current v time (78.1B)

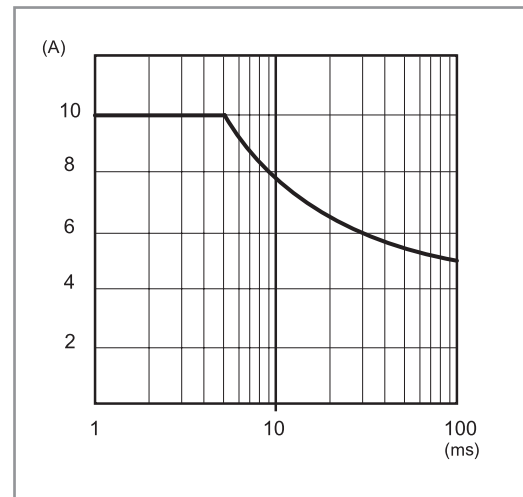

L78-9 Output current v ambient temperature (78.1D)

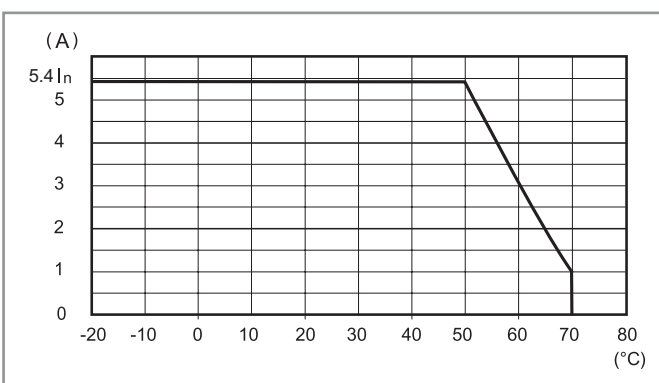

P78-9 Output peak current v time (78.1D)

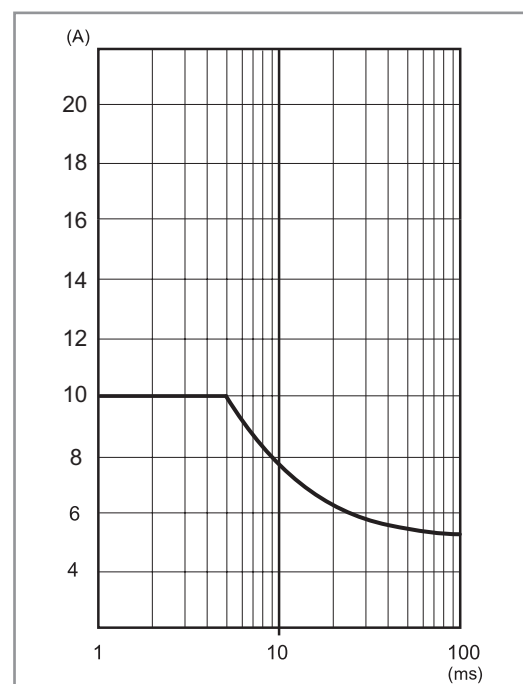

Output specification

L78-10 Output current v ambient temperature (78.2A)

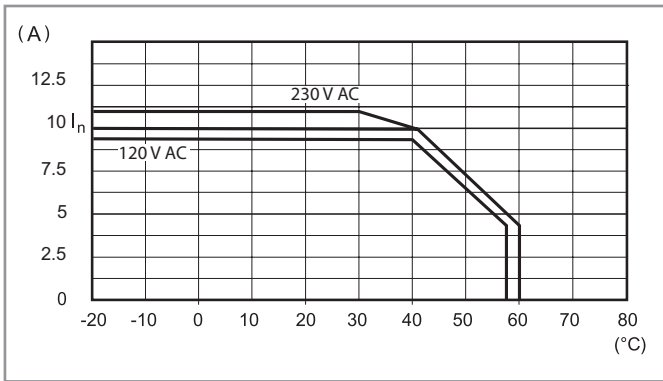

P78-10 Output peak current v time (78.2A)

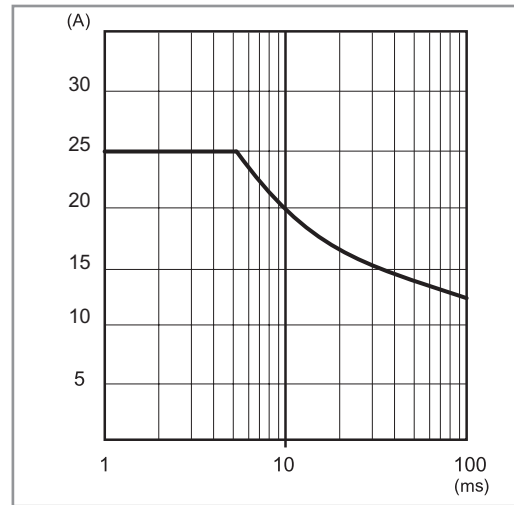

L78-11 Output current v ambient temperature (78.2E)

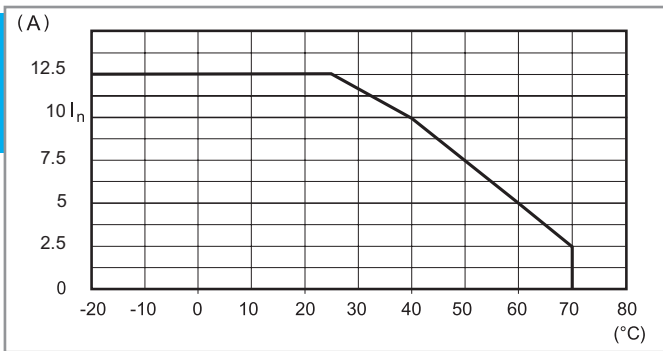

P78-11 Output peak current v time (78.2E)

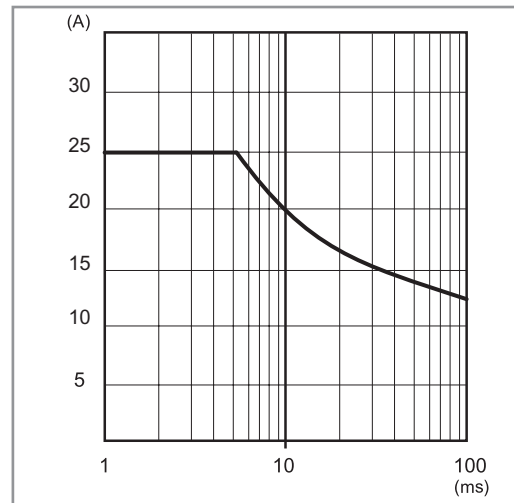

F

Output specification

L78-12 Output current v ambient temperature (78.J1)

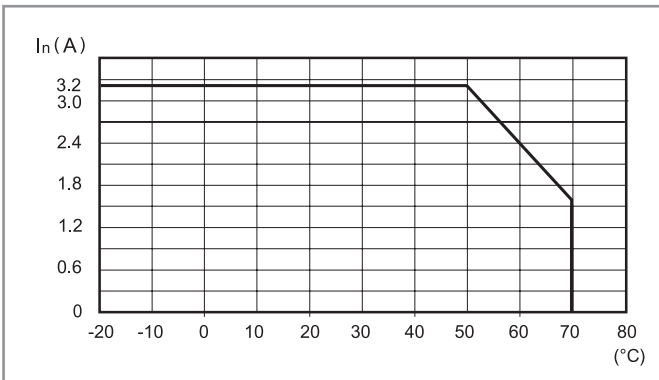

L78-13 Output current v ambient temperature (78.W1)

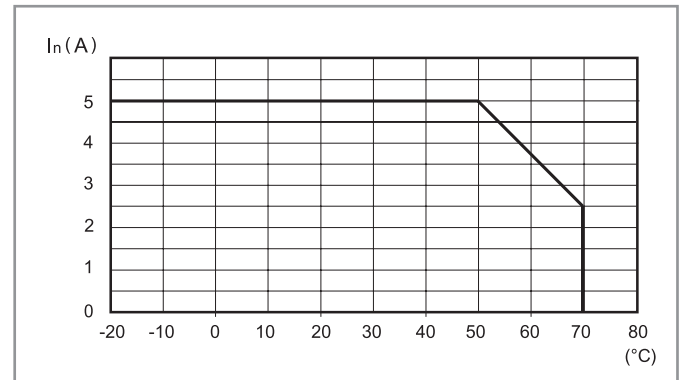

L78-14 Output current v ambient temperature (78.X1)

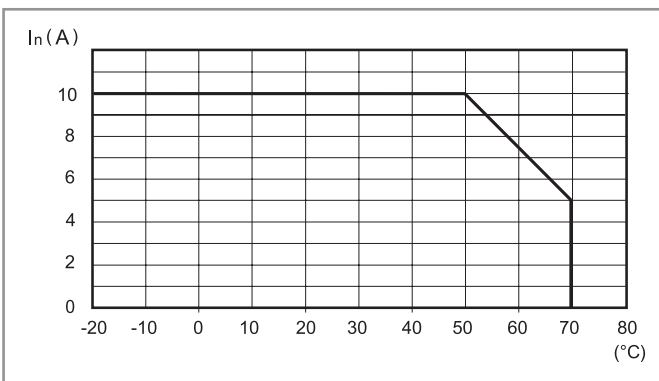

L78-15 Output current v ambient temperature (78.Y1)

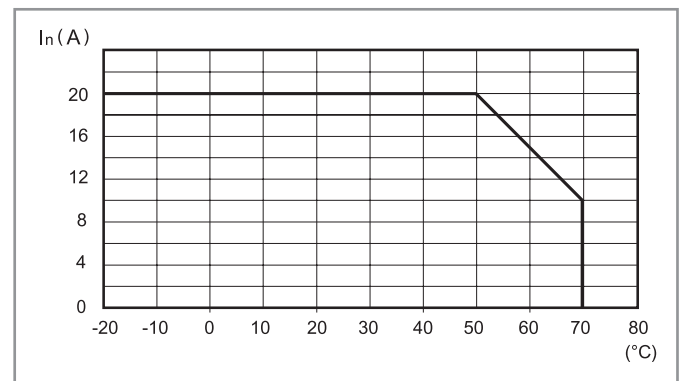

L78-16 Output current v ambient temperature (78.H2)

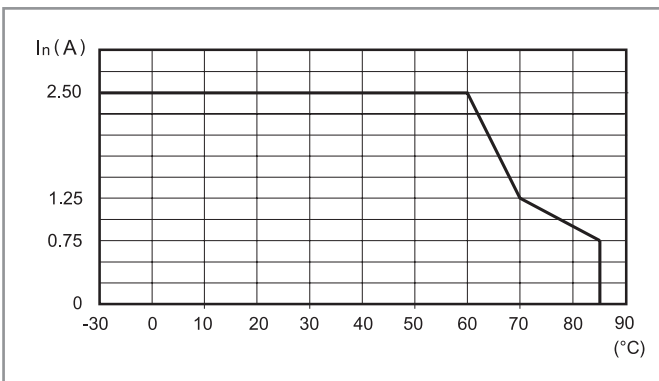

L78-17 Output current v ambient temperature (78.W2)

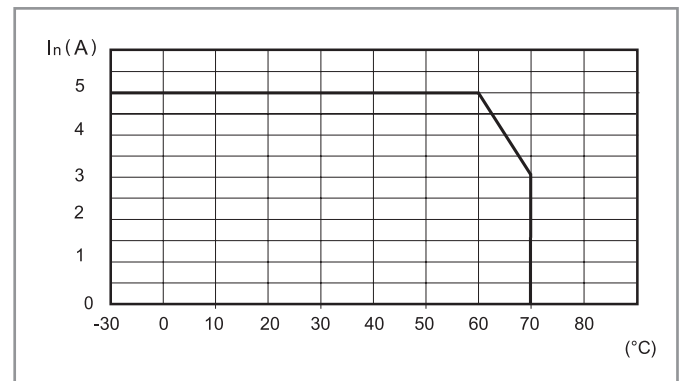

L78-18 Output current v ambient temperature (78.X2)

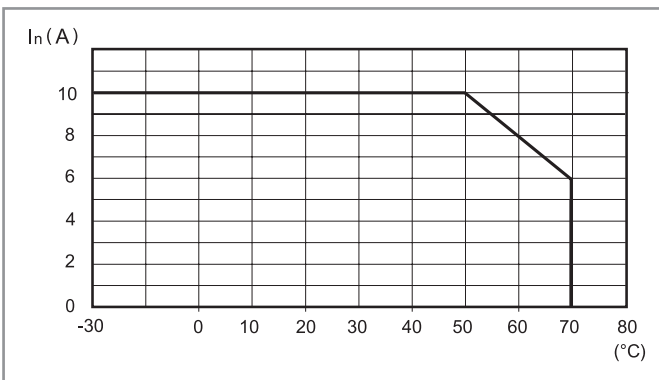

L78-19 Output current v ambient temperature (78.Y2)

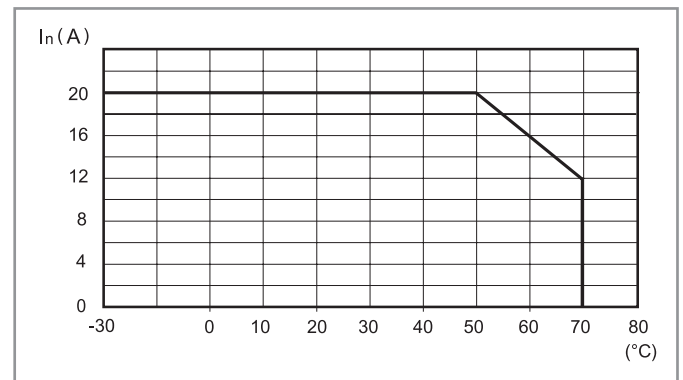

Output specification

L78-20 Output current v ambient temperature (78.X3)

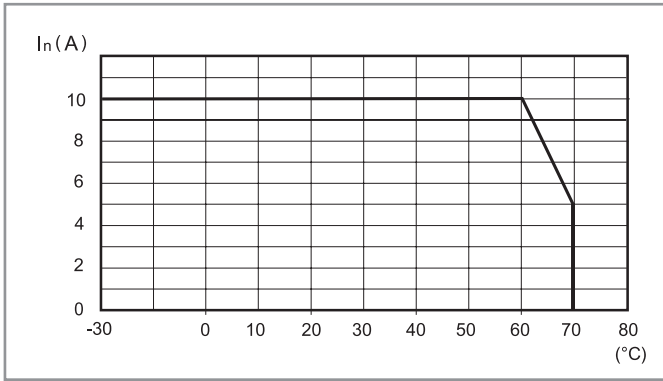

L78-21 Output current v ambient temperature (78.Y3)

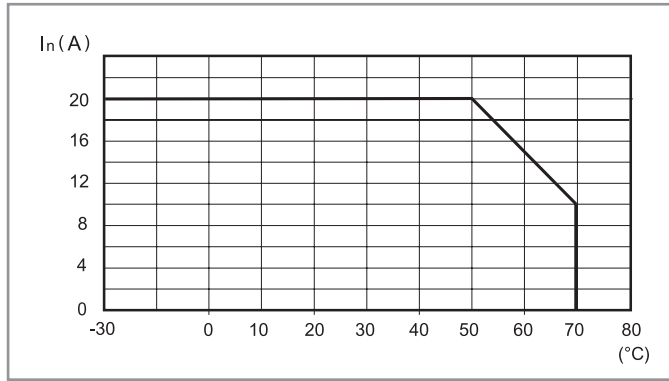

L78-22 Output current v ambient temperature (78.Z3)

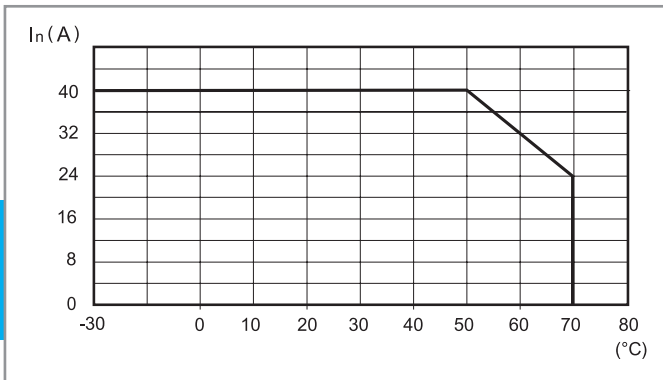

F

Output specification

FB78-5 Output voltage v output current (78.2E)

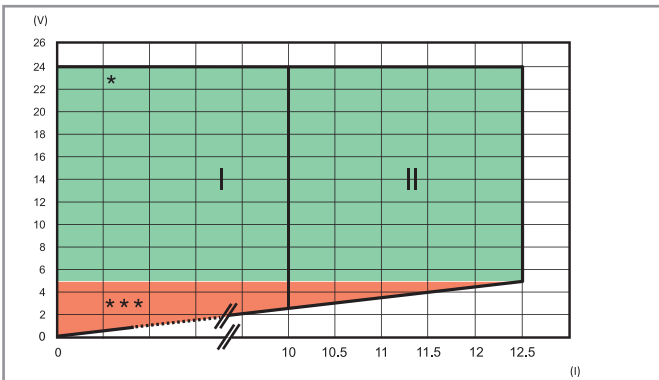

I: Output characteristic for temperature up to 50 °C

II: Output characteristic for temperature up to 25 °C

* / ** / ***: See LED table below

Hiccup mode

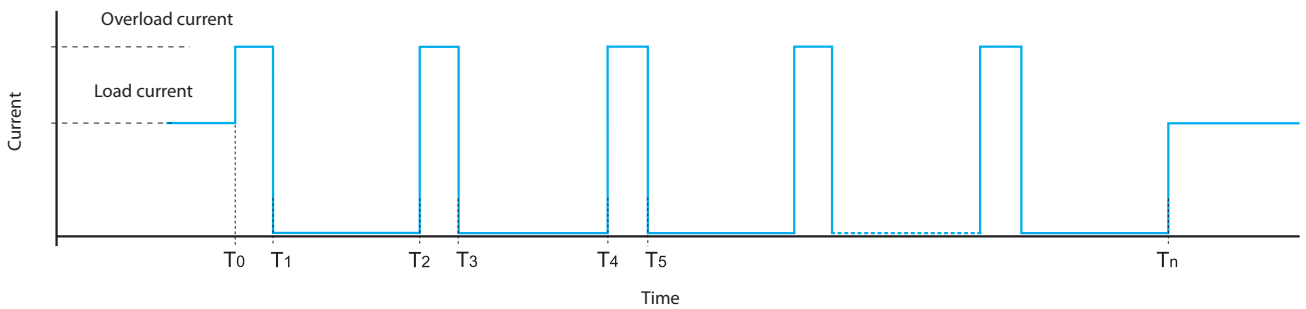

Under normal conditions, the 78 Series Power Supply supplies the current required by the load.

However, under abnormal conditions such as a short circuit or heavy overload (T_0) the output voltage will be rapidly reduced to zero - followed by the current (T_1). After approximately 2 seconds (T_1 to T_2), the power supply checks for the persistence of the anomaly over the time period T_2 to T_3 (30 to 100ms - dependent on the type of anomaly). If the anomaly persists, as shown above, the current is again reset to 0 A for a further 2 s (T_3 to T_4). This "hiccup" process is repeated until the anomaly is removed (T_n), whereon the power supply then returns to normal working.

78.1B is able to handle this anomaly for 15 s. After this time it enters in protection mode, and a manual reset is necessary by removing and re-applying the supply voltage

Fold-back technology and battery charging

Fold-back technology allows load current to be maintained under conditions of heavy overload. In case of heavy overload, the fold-back circuit will provide the output current and the output voltage, in accordance with the relevant "FB" diagram. In practice, when overcurrent is drawn by the load, the fold-back circuit reduces the output voltage supplying the current up to the maximal value, then it starts to work in hiccup mode. Also in case of short circuit, the power supply will work in hiccup mode. Both these conditions end when the anomaly is removed, and the power supply returns to normal working.

The fold-back mode allows the use of the power supply as a **battery charger**, in particular 78.36/50/60 for charging lead acid batteries (both standard and gel types) rated 7...24 Ah and 78.1D for charging lead batteries rated 17...38 Ah. In any case, it is necessary to verify that the charging characteristics of the batteries are compliant with the output characteristics of the power supply.

It is suggested to insert a diode in series between the + output and the + input of the battery (if not already installed in the battery unit).

Back-up connection for mains interruption

When the mains is ON, the power supply is able to charge the battery and supply the load at the same time (the power supply must be rated minimum 110 % of the load). When the mains is OFF, the battery starts to supply the load.

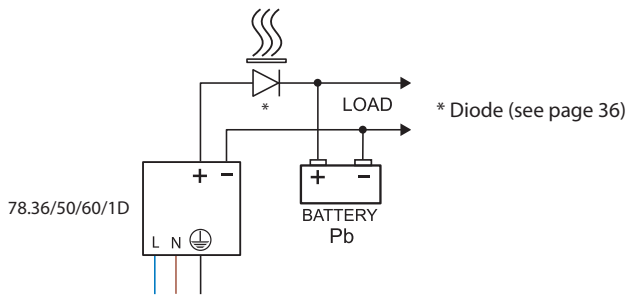

FB78-1 Output voltage v output current (78.50)

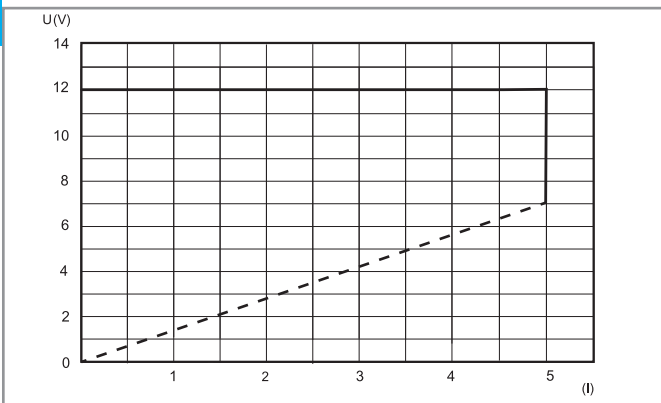

FB78-2 Output voltage v output current (78.60)

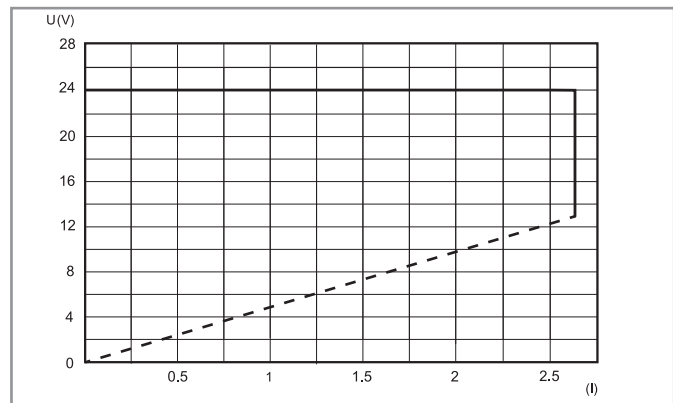

FB78-3 Output voltage v output current (78.1D)

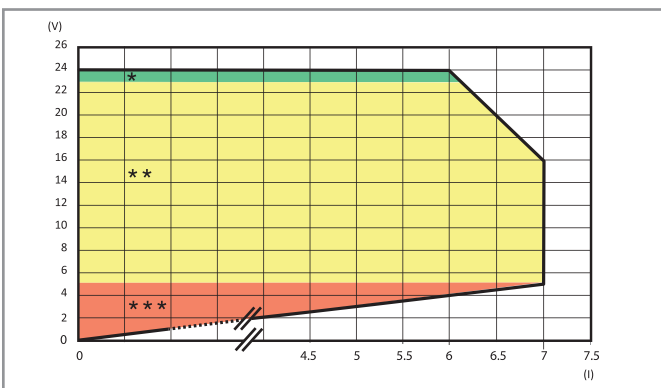

Fold-back characteristic for ambient temperature up to 50 °C

* / ** / ***: See LED table below

78.1D, 78.2E LED table

Feedback contact switching mode: Type 78.xx.x.xxx.24x4 ("positive logic")

The NO contact closes when power is applied to the unit and remains closed unless there is a serious fault preventing the power supply unit from delivering output current. (Such as a broken fuse, power supply failure, short-circuit or thermal protection.)

This version is suitable, for example, for signalling to a remote PLC all those alarms representing a service interruption of the power supply output.

Type	Area	State	LED	Contact 13-14	
78.1D.1.230.2414 78.2E.1.230.2414	*	OK	DC OK ALARM	 OFF	
	**	Overload (78.1D only)	DC OK ALARM	 OFF	
	***	Short circuit	DC OK ALARM	 OFF	
		Thermal limit	DC OK ALARM	 	
		Thermal protection [#]	DC OK ALARM	OFF 	

[#]Remove the supply voltage, following the intervention of the thermal protection, in order to reset the power supply.

78.1D, 78.2E LED table

Feedback contact switching mode: Type 78.xx.x.xxx.24x5 ("pre-alarm")

The NO contact closes when an anomaly happens (Overload, short circuit, thermal limit, thermal protection).

This version is suitable, for example, for activating visual or audible alarms, or to activate a cooling fan.

Type	Area	State	LED	Contact 13-14	
78.1D.1.230.2415 78.2E.1.230.2415	*	OK	DC OK ALARM	 OFF	
	**	Overload (78.1D only)	DC OK ALARM	 OFF	
	***	Short circuit	DC OK ALARM	 OFF	
		Thermal limit	DC OK ALARM	 	
		Thermal protection [#]	DC OK ALARM	OFF 	

[#]Remove the supply voltage, following the intervention of the thermal protection, in order to reset the power supply.

78.12, 78.25, 78.36, 78.50, 78.60, 78.1A, 78.2A, 78.1B LED table

Type	State	LED
78.12.1.230.xx00 78.12.1.230.xx02	OK	
78.12.1.230.2482 78.25.1.230.1202 78.25.1.230.2400	Short circuit	
78.25.1.230.2482 78.36.1.230.xx02 78.50.1.230.1202 78.60.1.230.2402 78.1A.1.230.2402	Thermal limit	OFF
78.2A.1.230.2402 78.1B.1.230.2403	OK	
	Short circuit	 15s OFF
	Thermal limit	OFF

Wiring diagrams for 78.12, 78.25, 78.36, 78.50, 78.60

Basic connections

Basic connections

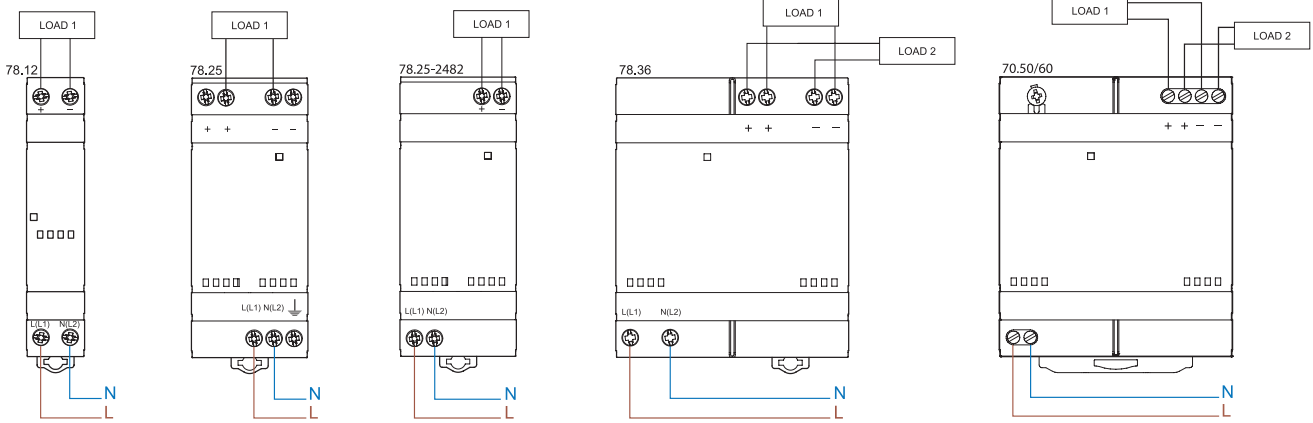

Dual polarity connection

Dual polarity connection

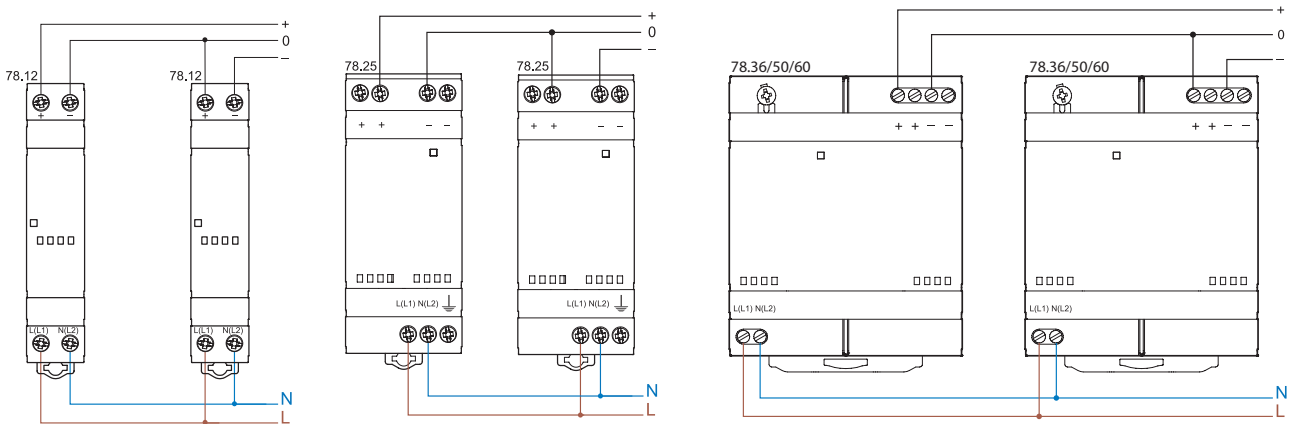

Series connection

Series connection

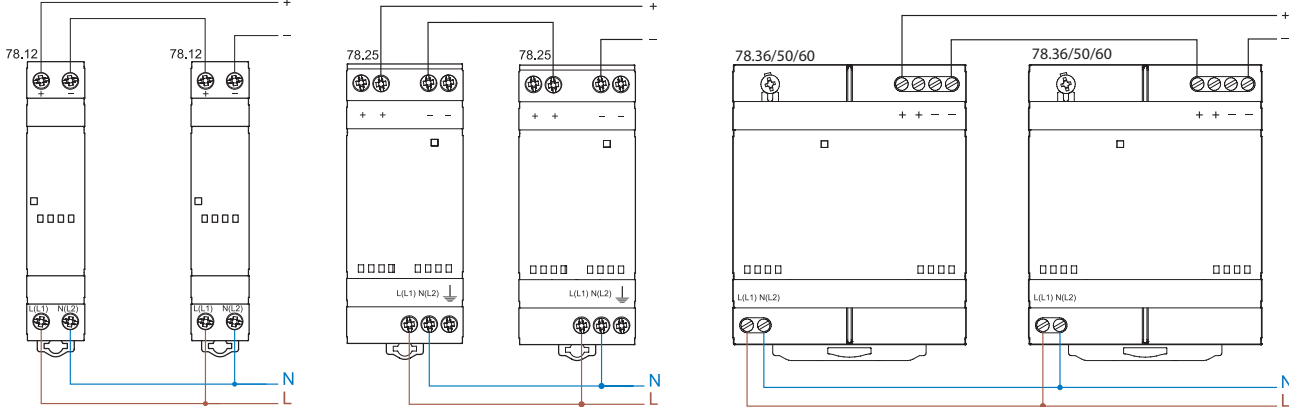

Parallel connection (78.50/60 only)

Manual redundancy

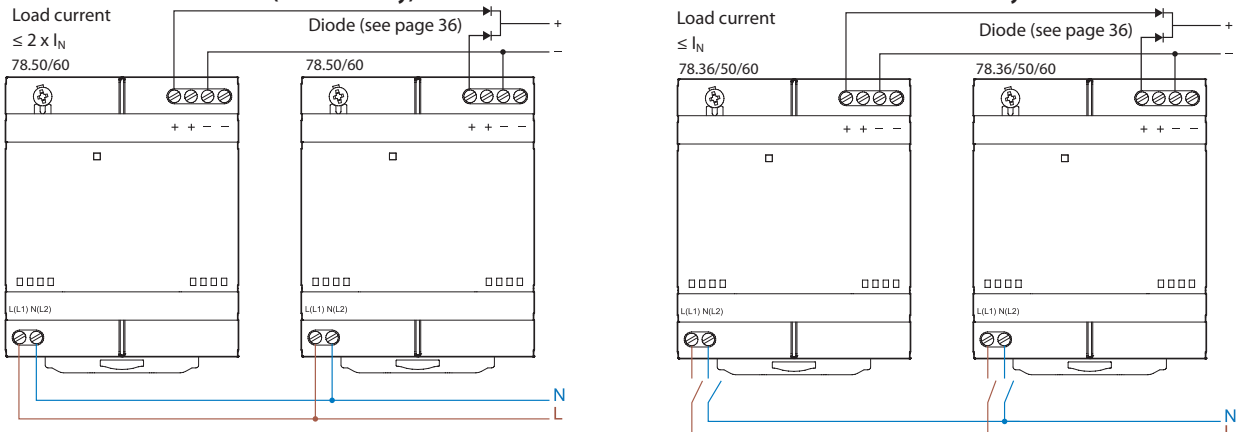

F

Wiring diagrams for 78.12 OPTA

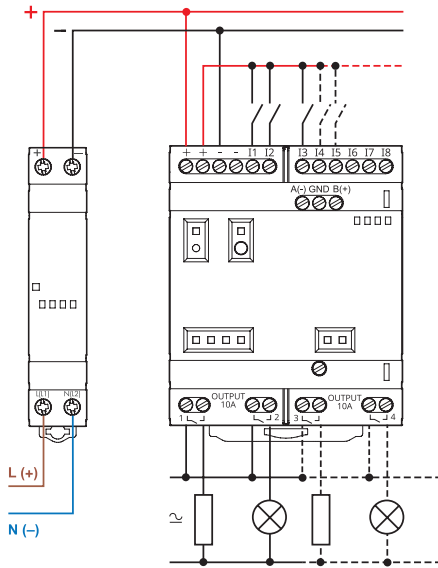

Wiring diagrams for 78.12...2482 OPTA + expansion modules

Up to 1 OPTA and 5 expansion modules

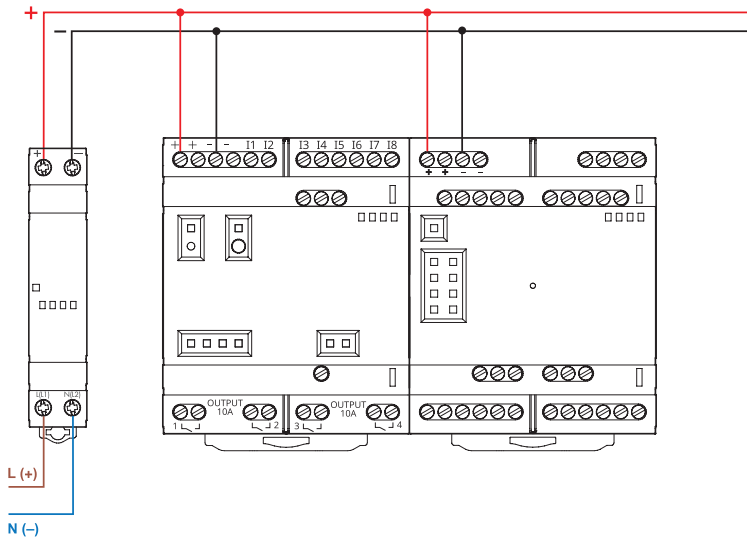

Wiring diagrams for 78.25...2482 OPTA + expansion modules

Up to 2 groups of 1 OPTA and 5 expansion modules

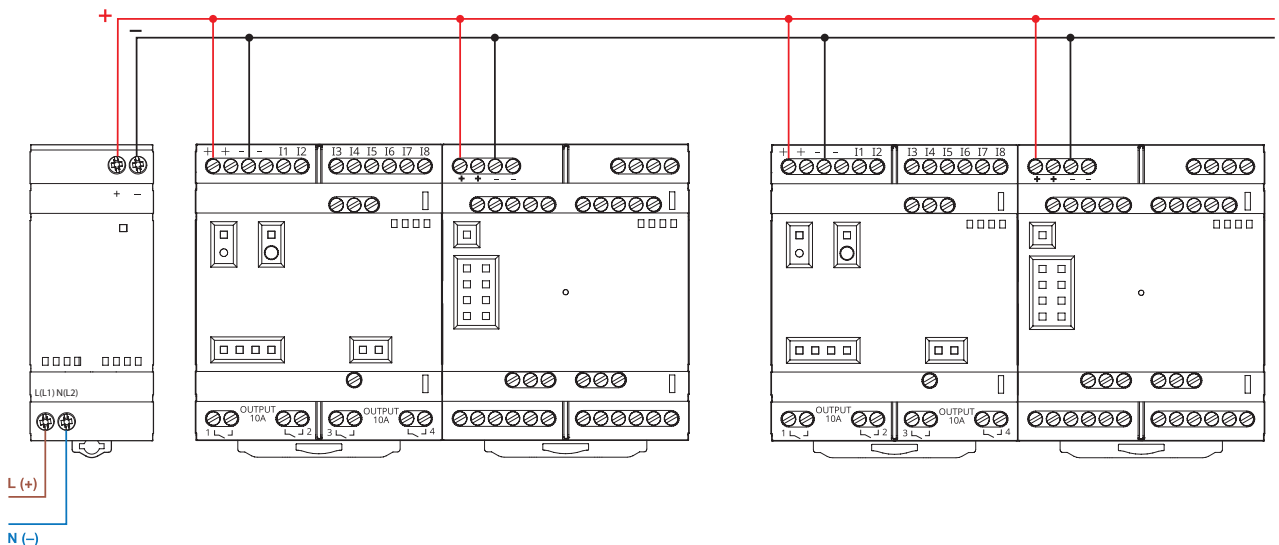

Wiring diagrams for 78.1B & 78.1D

Basic connections

78.1B - Power supply connection

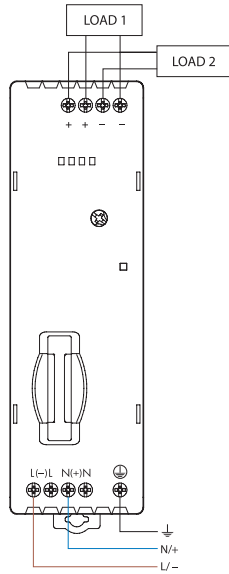

78.1D - Power supply connection

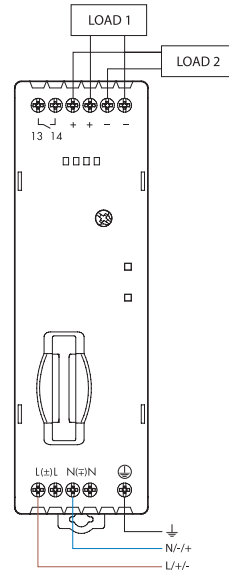

Dual polarity connection

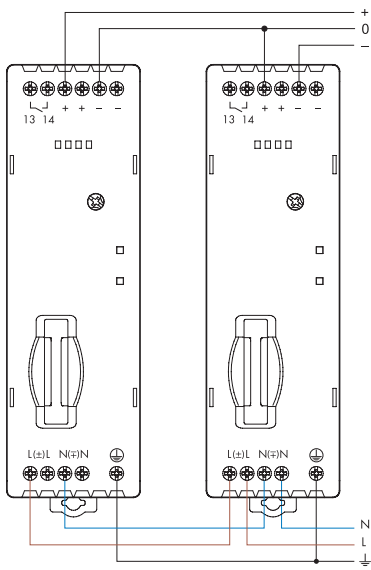

Parallel connection

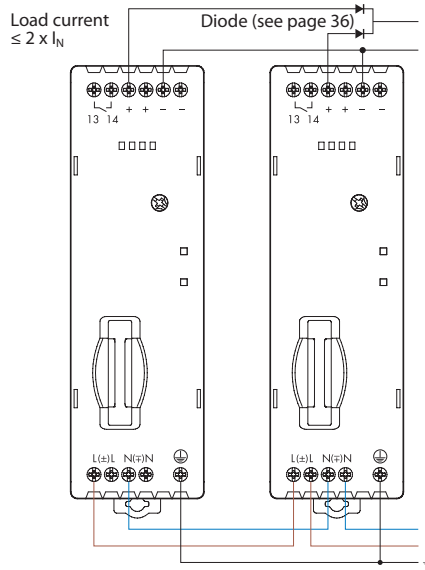

Series connection

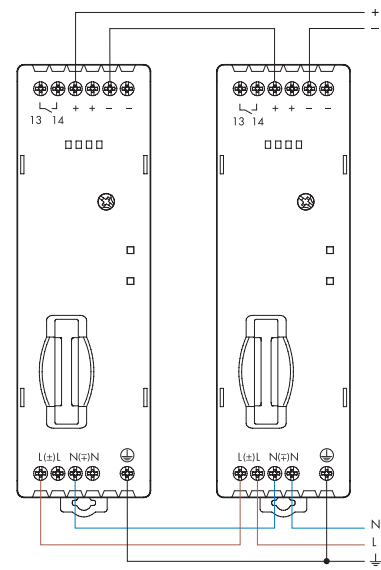

F

Wiring diagrams for 78.2E

Basic connections

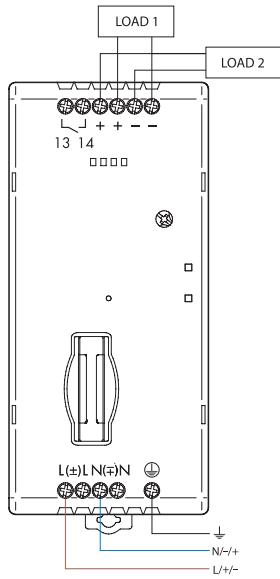

Dual polarity connection

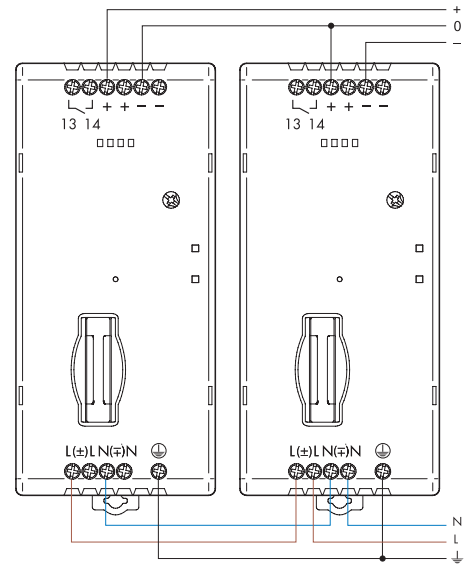

Parallel connection

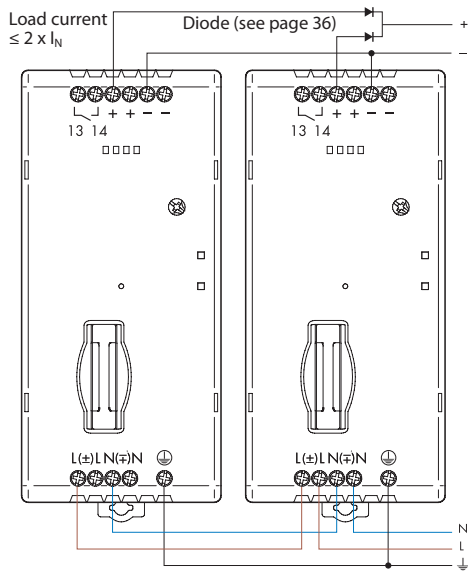

Series connection

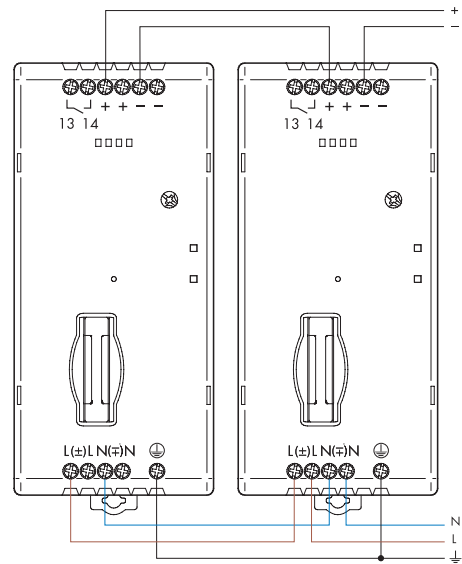

Wiring diagram for 78.1A

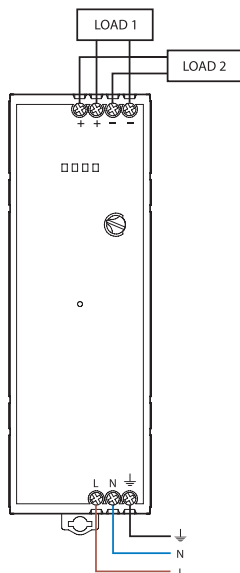

Wiring diagram for 78.2A

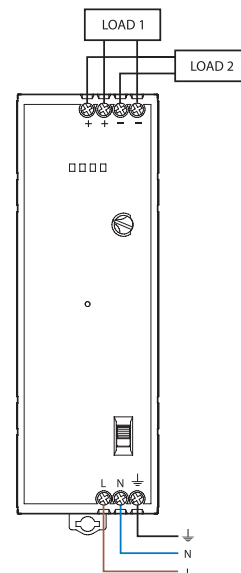

Wiring diagrams for 78.J1, 78.W1, 78.X1, 78.Y1, 78.H2, 78.W2

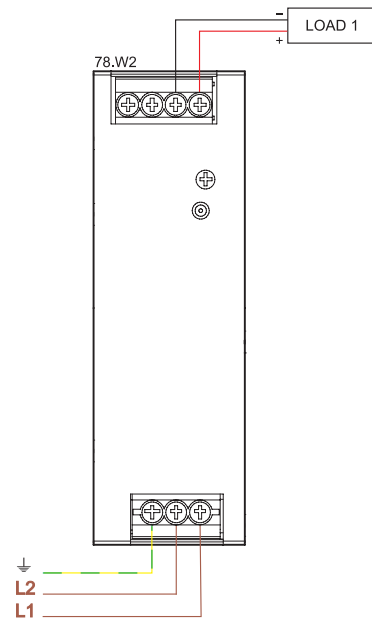
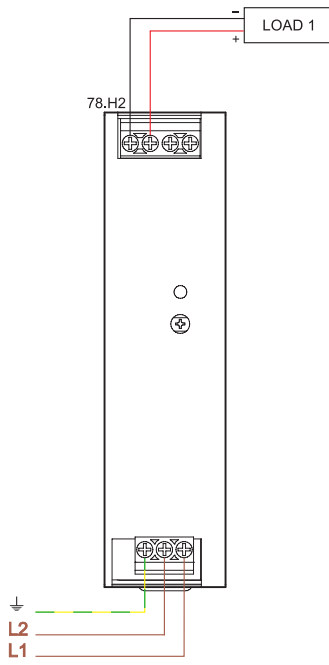
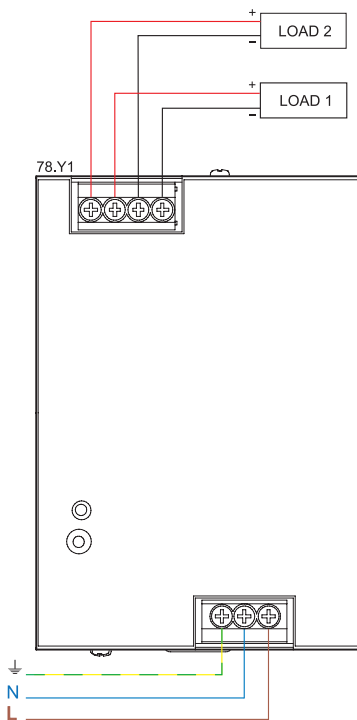
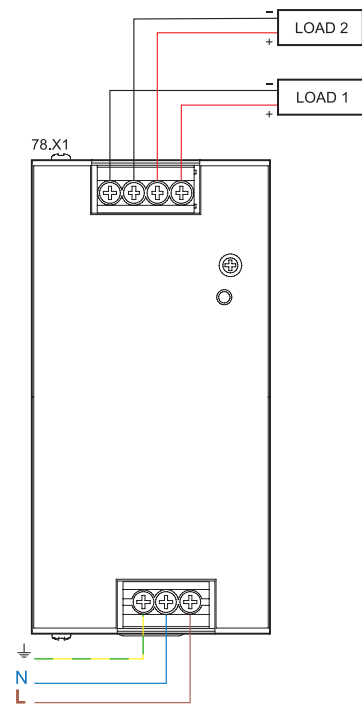
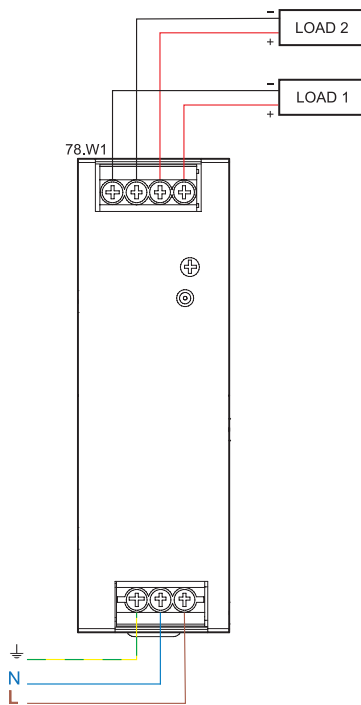
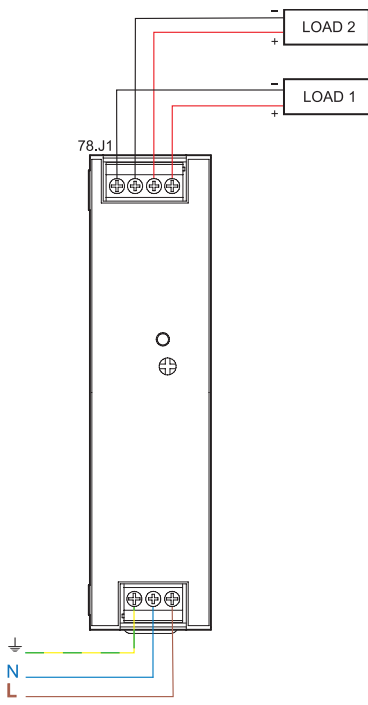

F

Wiring diagrams for 78.X2, 78.Y2, 78.X3, 78.Y3, 78.Z3

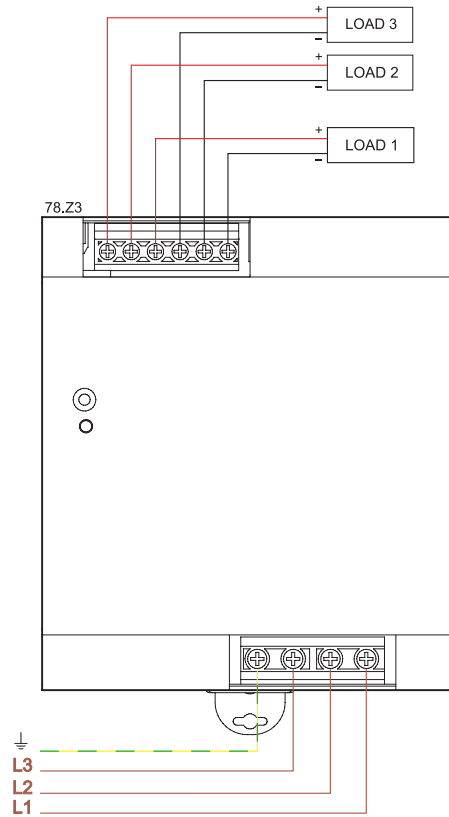
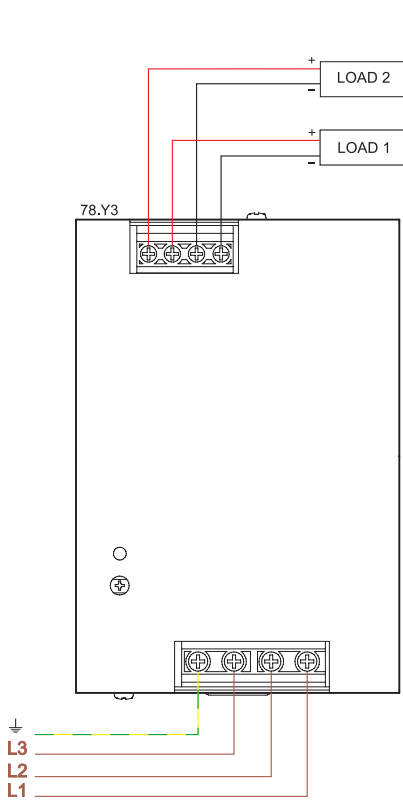
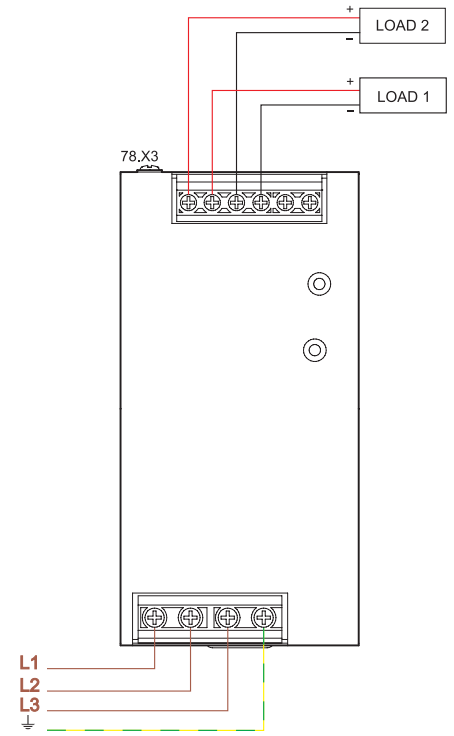
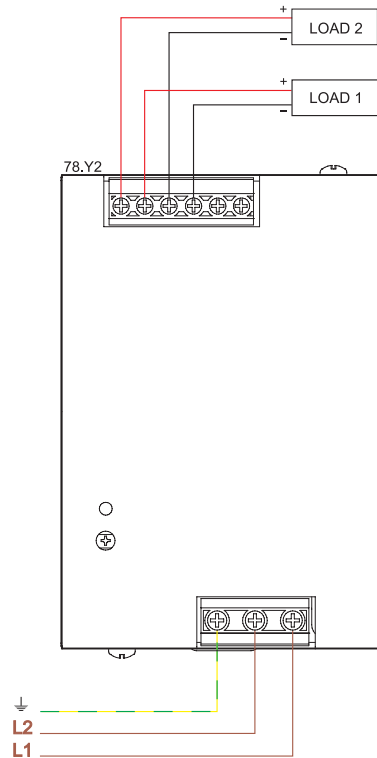
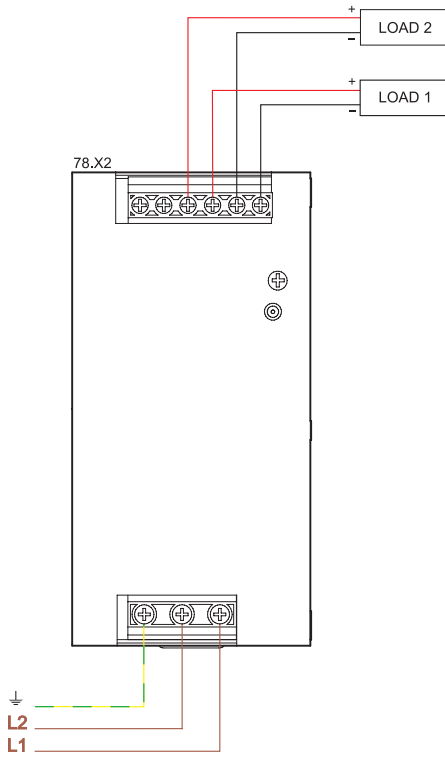

Diode(s)

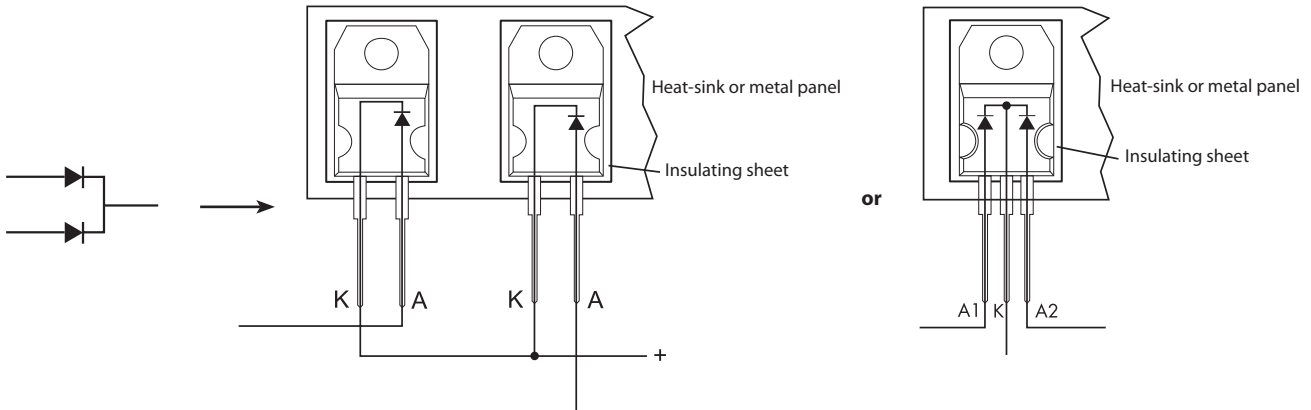

Diode for type 78.25, 78.36, 78.50, 78.60

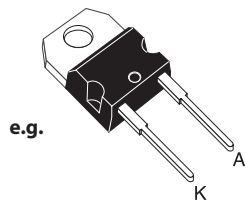

e.g.

TO-220AC
STPS1545D

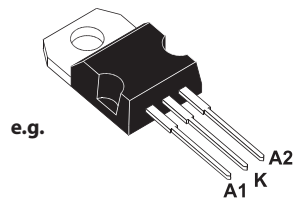

e.g.

TO-220AB
STPS30L40CT

Diode for type 78.1B, 78.1D, 78.2E

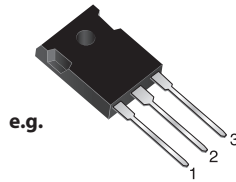

e.g.

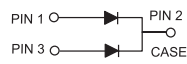

TO-247AD
MBR 4060PT

Outline drawings

Type 78.12
Box clamp

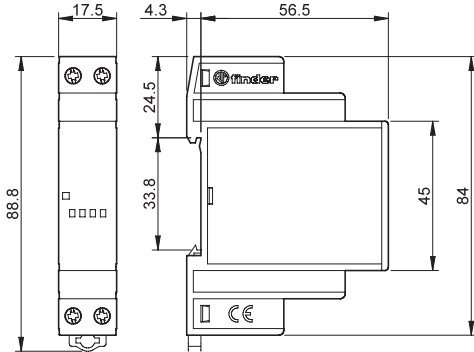

Type 78.25
Box clamp

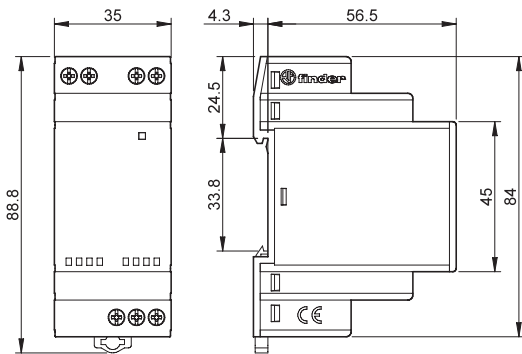

Type 78.25-2482
Box clamp

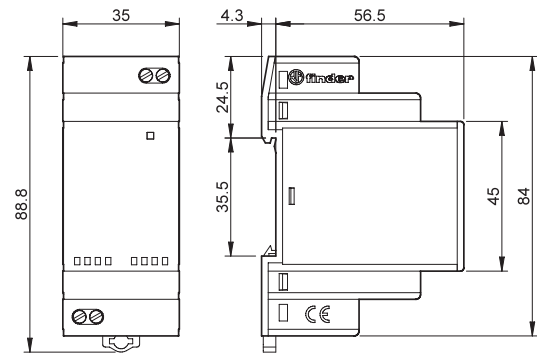

Type 78.36/78.50/78.60
Box clamp

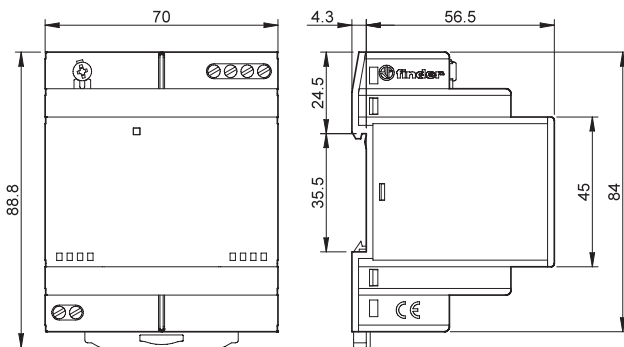

Type 78.1B
Box clamp

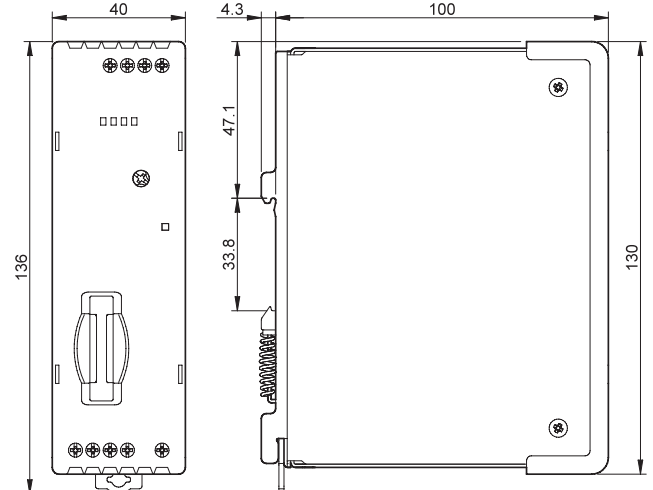

Outline drawings

Type 78.1D
Box clamp

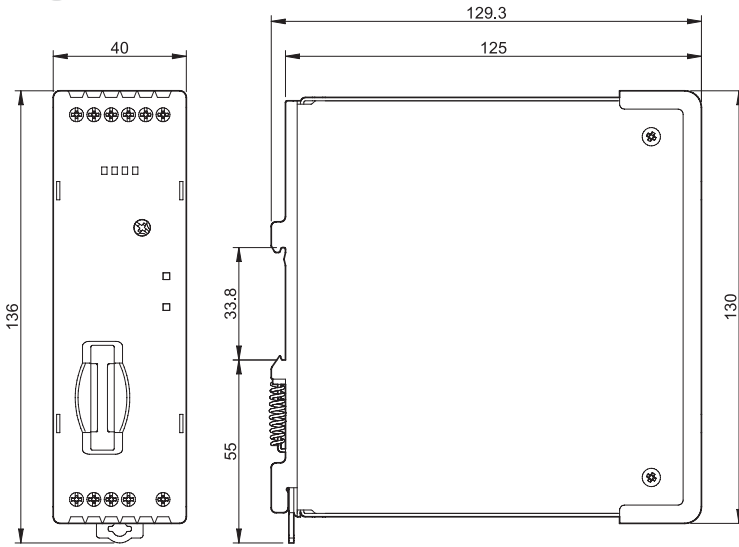

F

Type 78.2E
Box clamp

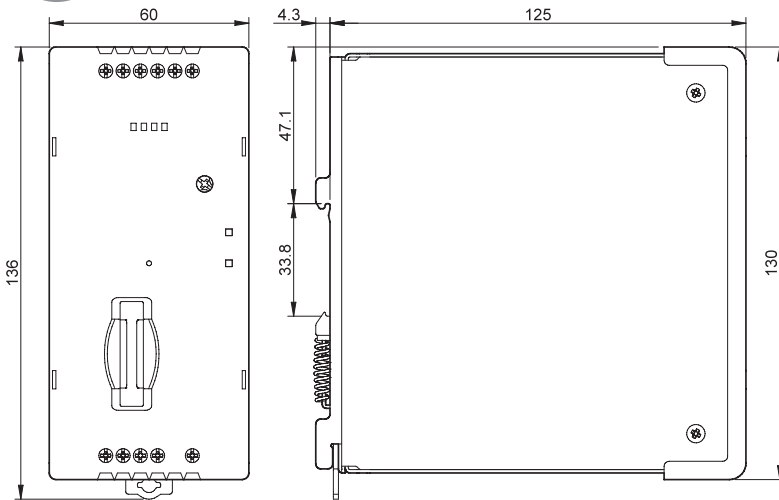

Outline drawings

Type 78.1A

Box clamp

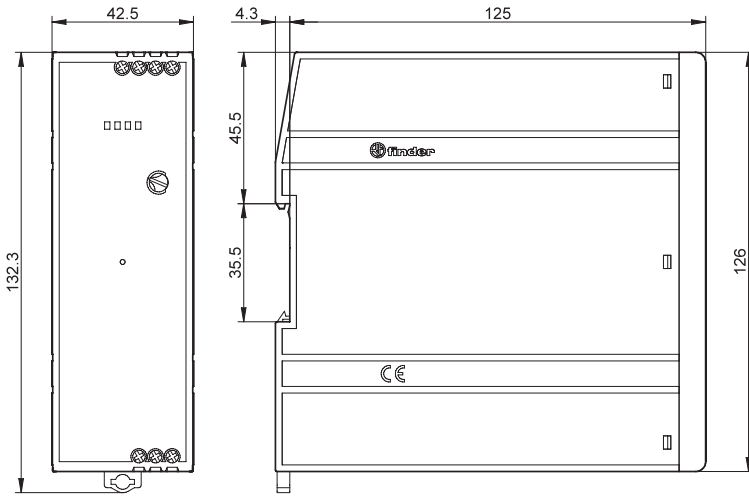

Type 78.2A

Box clamp

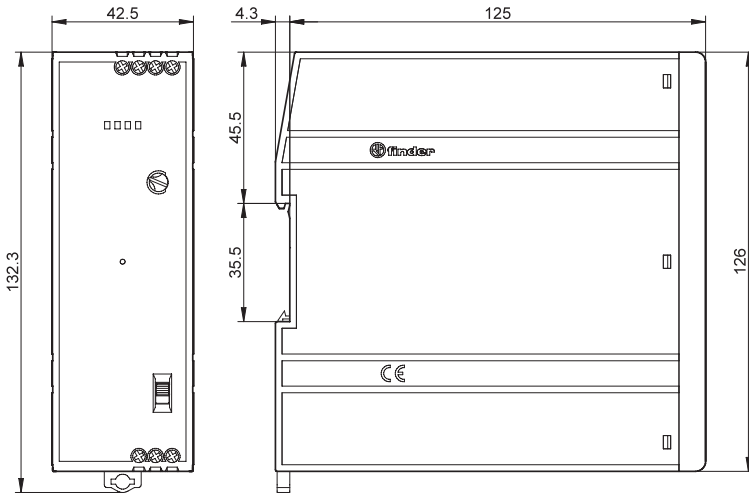

Outline drawings

Type 78.J1
Box clamp

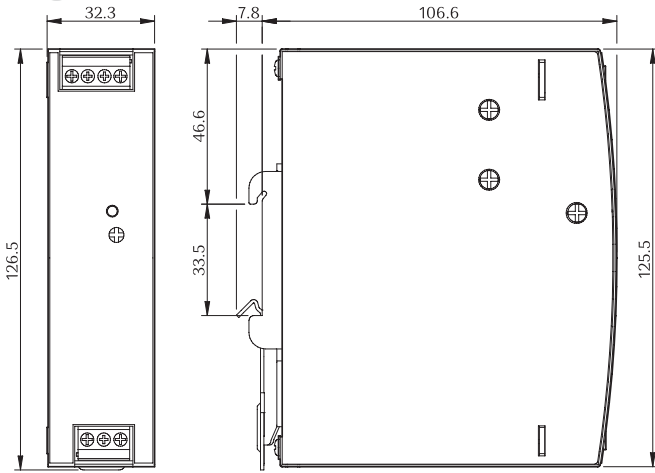

Type 78.W1
Box clamp

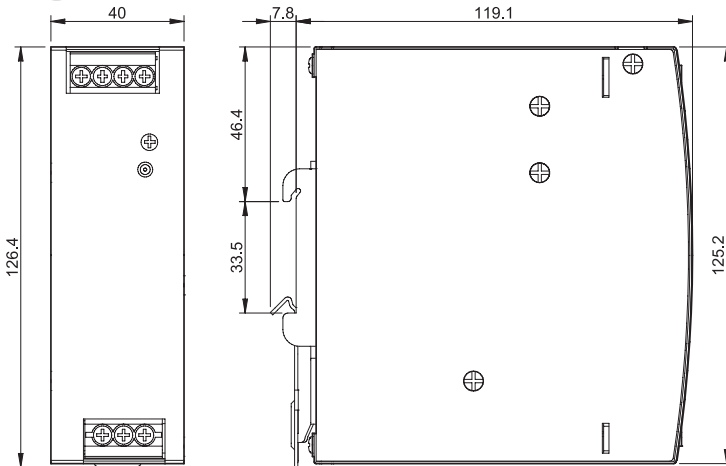

Type 78.X1
Box clamp

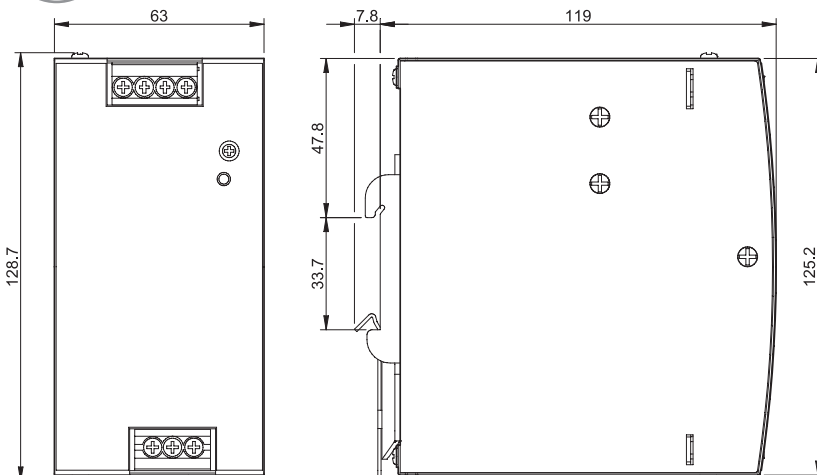

Outline drawings

Type 78.Y1
Box clamp

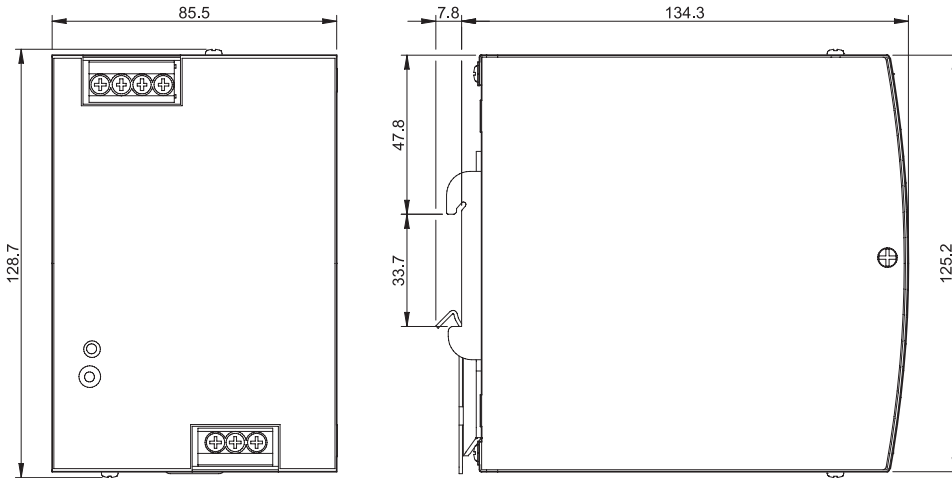

Type 78.H2
Box clamp

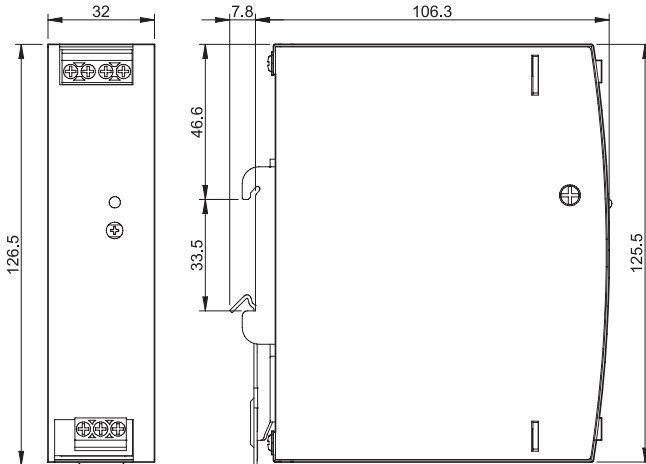

Type 78.W2
Box clamp

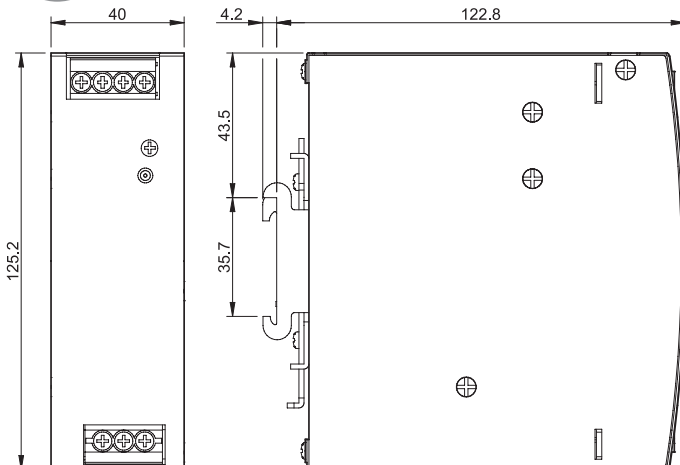

Outline drawings

Type 78.X2
Box clamp

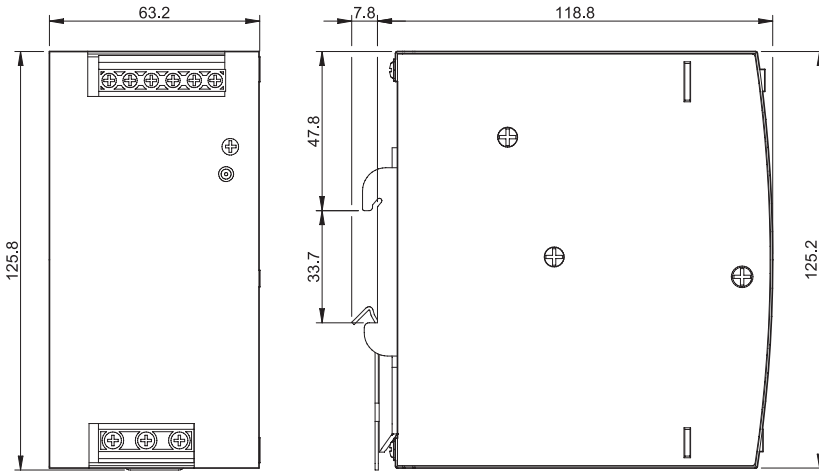

Type 78.Y2
Box clamp

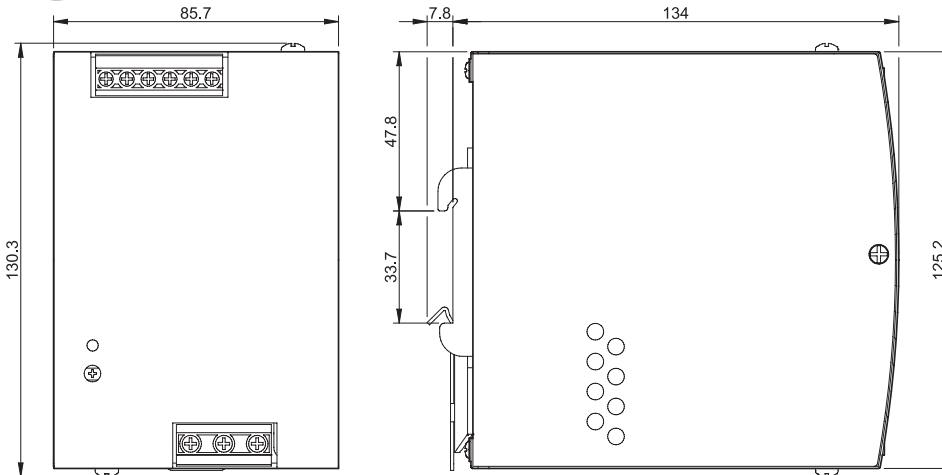

Type 78.X3
Box clamp

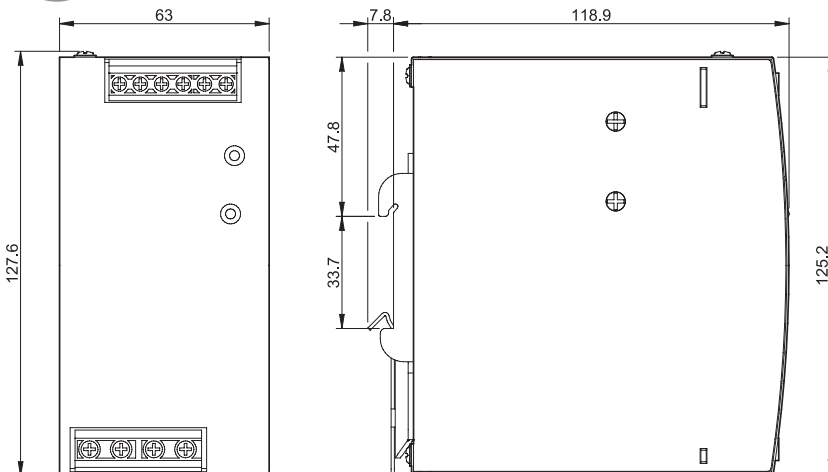

Outline drawings

Type 78.Y3
Box clamp

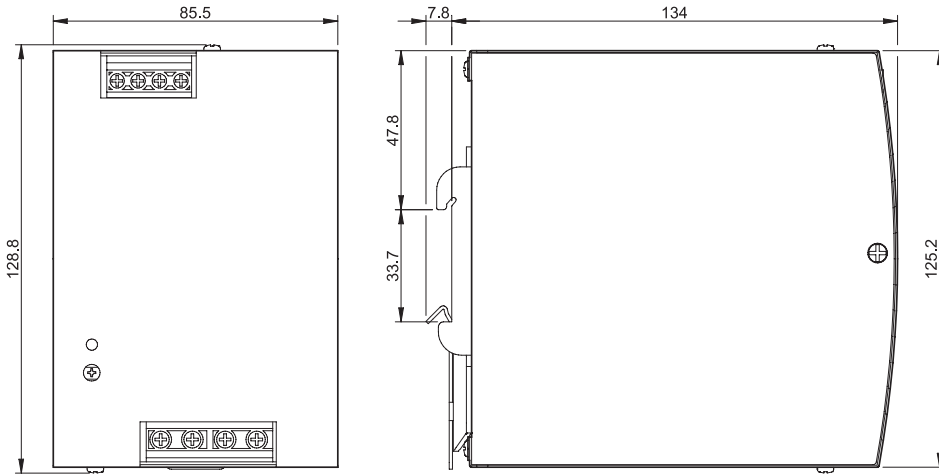

Type 78.Z3
Box clamp

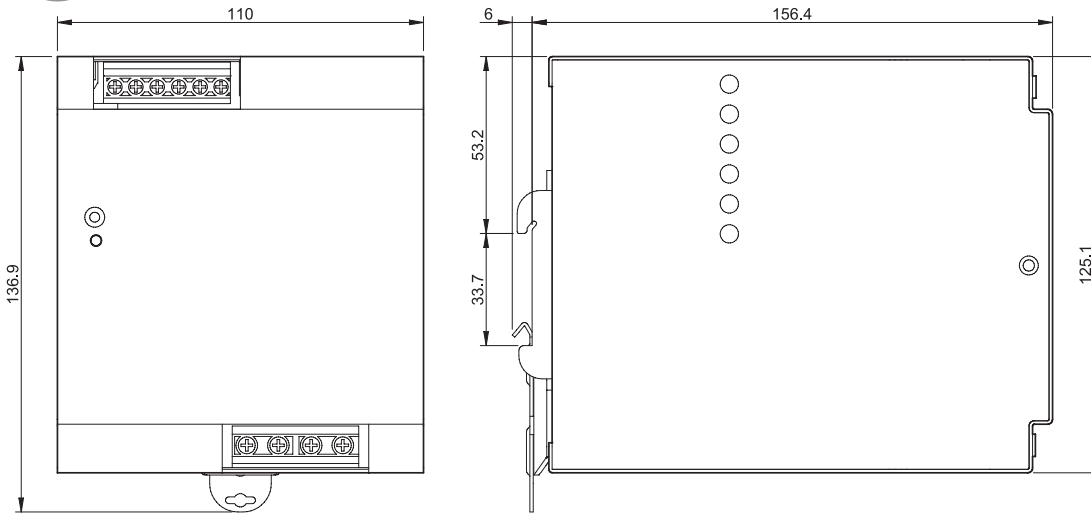

Accessories

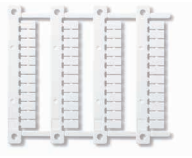

060.48

Sheet of marker tags (CEMBRE Thermal transfer printers), (48 tags), 6 x 12 mm

060.48

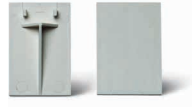

019.01

Identification tag, plastic, 1 tag, 17 x 25.5 mm (for 78.12/25/36/50/60)

019.01