

Automotive 650 V, 20 A high surge silicon carbide power Schottky diode

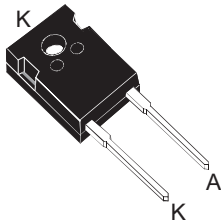

DO-247 LL



Product label



Product status link

[STPSC20G065-Y](#)

Product summary

$I_{F(AV)}$	20 A
V_{RRM}	650 V
T_j (max.)	175 °C
V_F (typ.)	1.30 V

Features

- AEC-Q101 qualified and PPAP capable 
- No reverse recovery charge in application current range
- Switching behavior independent of temperature
- High forward surge capability
- Operating T_j from -55 °C to 175 °C
- ECOPACK2 compliant component

Applications

- OBC (On board battery chargers)
- EV Charging station

Description

The SiC diode STPSC20G065-Y, moulded in DO-247 LL with long leads, is an ultrahigh performance power Schottky rectifier. It is manufactured using a silicon carbide substrate. The wide band-gap material allows the design of a low V_F Schottky diode structure with a 650 V rating. Due to the Schottky construction, no recovery is shown at turn-off and ringing patterns are negligible. The minimal capacitive turn-off behavior is independent of temperature.

Based on latest technology optimization, this diode has an improved forward surge current capability, making it ideal for use in PFC, where this **ST SiC diode** boosts the performance in hard switching conditions. Using the latest design improvement of the “G” series of ST SiC diodes, as well as implemented tests in production, this diode is becoming the reference point in the combination of efficiency and application robustness to the application design.

1 Characteristics

Table 1. Absolute ratings (limiting values at 25 °C, unless otherwise specified)

Symbol	Parameter		Value	Unit	
V_{RRM}	Repetitive peak reverse voltage ($T_j = -55\text{ °C}$ to $+175\text{ °C}$)		650	V	
$I_{F(RMS)}$	Forward rms current		46	A	
$I_{F(AV)}$	Average forward current	$T_c = 135\text{ °C}$, $\delta = 1$	20	A	
I_{FRM}	Repetitive peak forward current		$T_c = 135\text{ °C}$, $T_j = 175\text{ °C}$, $\delta = 0.1$, $f_{sw} > 10\text{ kHz}$	82	A
I_{FSM}	Surge non repetitive forward current	$t_p = 10\text{ ms}$ sinusoidal	$T_c = 25\text{ °C}$	135	A
			$T_c = 150\text{ °C}$	110	
		$t_p = 10\text{ }\mu\text{s}$ square	$T_c = 25\text{ °C}$	850	
T_{stg}	Storage temperature range		-65 to +175	°C	
T_j	Operating junction temperature range		-55 to +175	°C	

Table 2. Thermal resistance parameters

Symbol	Parameter	Value		Unit
		Typ.	Max.	
$R_{th(j-c)}$	Junction to case	0.80	1.14	°C/W

For more information, please refer to the following application note:

- [AN5088](#) : Rectifiers thermal management, handling and mounting recommendations

Table 3. Static electrical characteristics

Symbol	Parameter	Test conditions		Min.	Typ.	Max.	Unit
$I_R^{(1)}$	Reverse leakage current	$T_j = 25\text{ °C}$	$V_R = V_{RRM}$	-	17	200	μA
		$T_j = 175\text{ °C}$		-	100	800	
$V_F^{(2)}$	Forward voltage drop	$T_j = 25\text{ °C}$	$I_F = 20\text{ A}$	-	1.30	1.45	V
		$T_j = 175\text{ °C}$		-	1.49	1.70	

1. Pulse test: $t_p = 10\text{ ms}$, $\delta < 2\%$

2. Pulse test: $t_p = 380\text{ }\mu\text{s}$, $\delta < 2\%$

To evaluate the conduction losses, use the following equation:

$$P = 0.879 \times I_{F(AV)} + 0.0405 \times I_{F(RMS)}^2$$

For more information, please refer to the following application notes related to the power losses:

- [AN604](#): Calculation of conduction losses in a power rectifier
- [AN4021](#): Calculation of reverse losses on a power diode

Table 4. Dynamic electrical characteristics

Symbol	Parameter	Test conditions	Min.	Typ.	Max.	Unit
$Q_{Cj}^{(1)}$	Total capacitive charge	$V_R = 400\text{ V}$	-	60	-	nC
C_j	Total capacitance	$V_R = 0\text{ V}, T_c = 25\text{ }^\circ\text{C}, F = 1\text{ MHz}$	-	1260	-	pF
		$V_R = 400\text{ V}, T_c = 25\text{ }^\circ\text{C}, F = 1\text{ MHz}$	-	83	-	

1. Most accurate value for the capacitive charge: $Q_{Cj}(V_R) = \int_0^{V_{out}} C_j(V_R) dV_R$

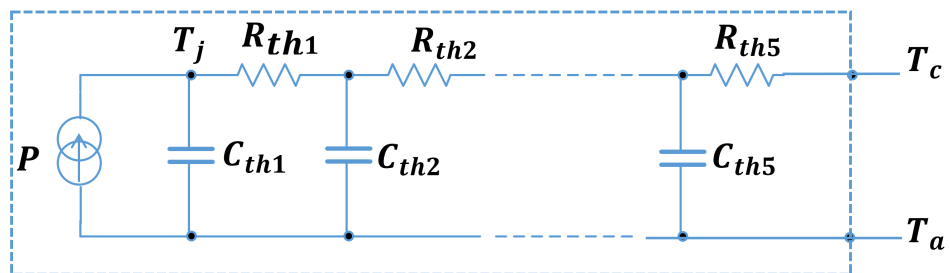
Figure 1. Thermal transient impedance model circuit of the diode – $Z_{th(j-c)}$

Table 5. Components typical values of the diode thermal transient impedance model $Z_{th(j-c)}$

Ref.	Value (K/W)	Ref.	Value (J/K)
R_{th1}	29.34 m	C_{th1}	1.18 m
R_{th2}	254.21 m	C_{th2}	1.09 m
R_{th3}	243.62 m	C_{th3}	6.59 m
R_{th4}	208.06 m	C_{th4}	40.71 m
R_{th5}	64.92 m	C_{th5}	484.42 m

1.1 Characteristics (curves)

Figure 2. Forward voltage drop versus forward current (typical values)

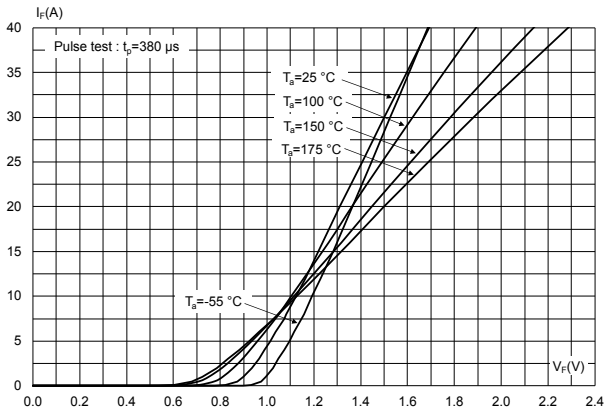

Figure 3. Reverse leakage current versus reverse voltage applied (typical values)

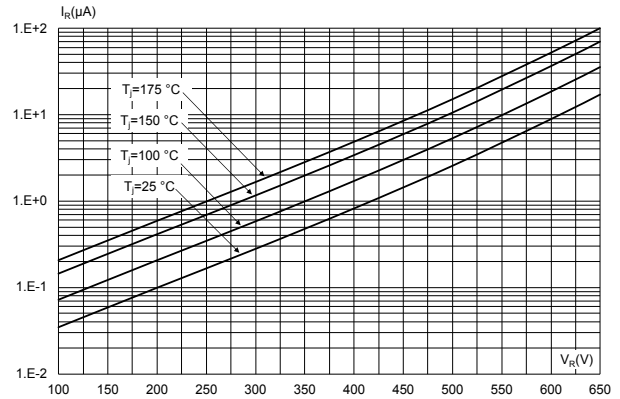

Figure 4. Peak forward current versus case temperature (fsw > 10 kHz)

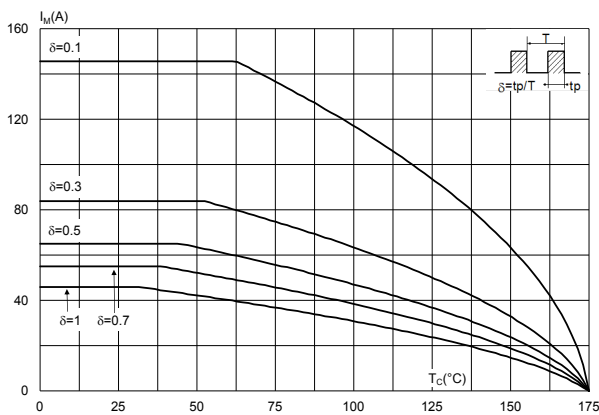

Figure 5. Junction capacitance versus reverse voltage applied (typical values)

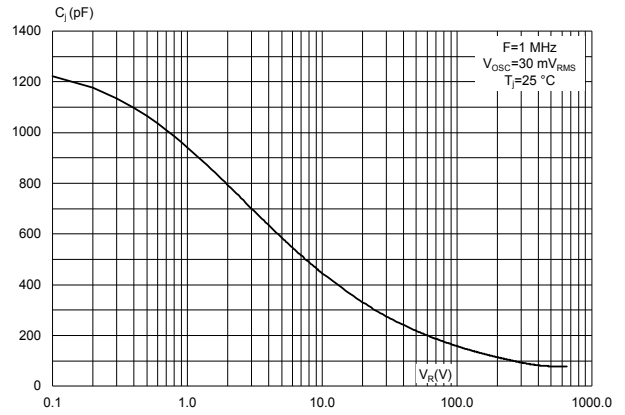

Figure 6. Relative variation of thermal impedance junction to case versus pulse duration

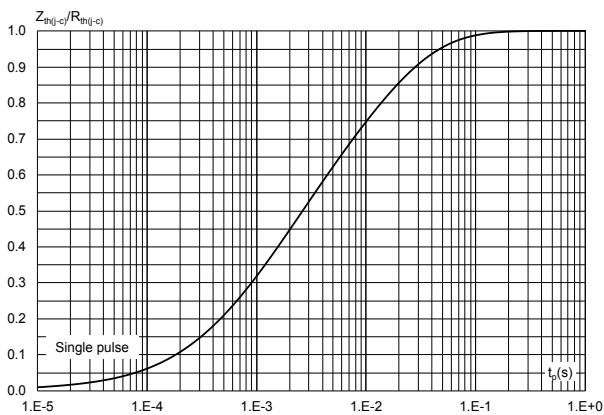

Figure 7. Non-repetitive peak surge forward current versus pulse duration (sinusoidal waveform)

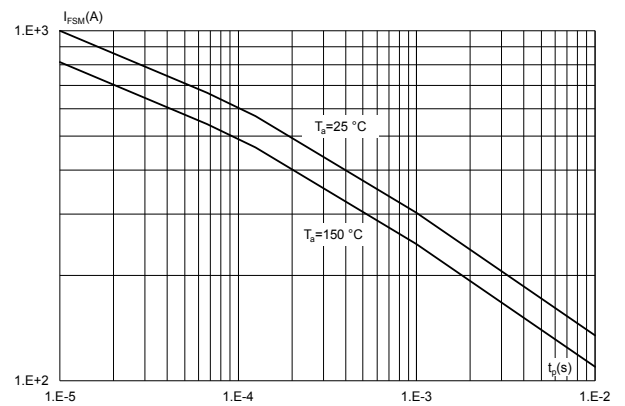
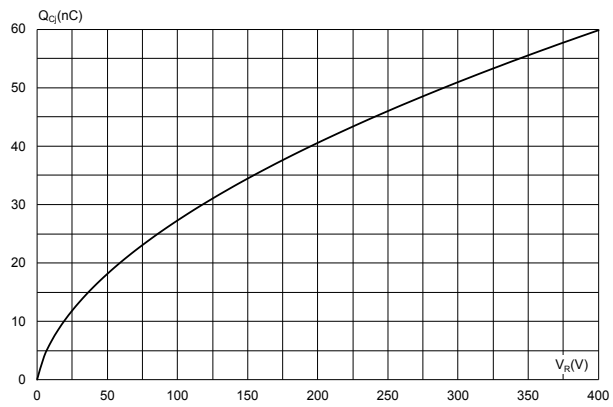

Figure 8. Total capacitive charges versus reverse voltage applied (typical values)



2 Package information

To meet environmental requirements, ST offers these devices in different grades of **ECOPACK** packages, depending on their level of environmental compliance. ECOPACK specifications, grade definitions, and product status are available at: www.st.com. ECOPACK is an ST trademark.

2.1 DO-247 LL package information

- Epoxy meets UL94, V0
- Cooling method: by conduction (C)
- Recommended torque value: 0.8 N·m
- Maximum torque value: 1.0 N·m

Figure 9. DO-247 LL package outline

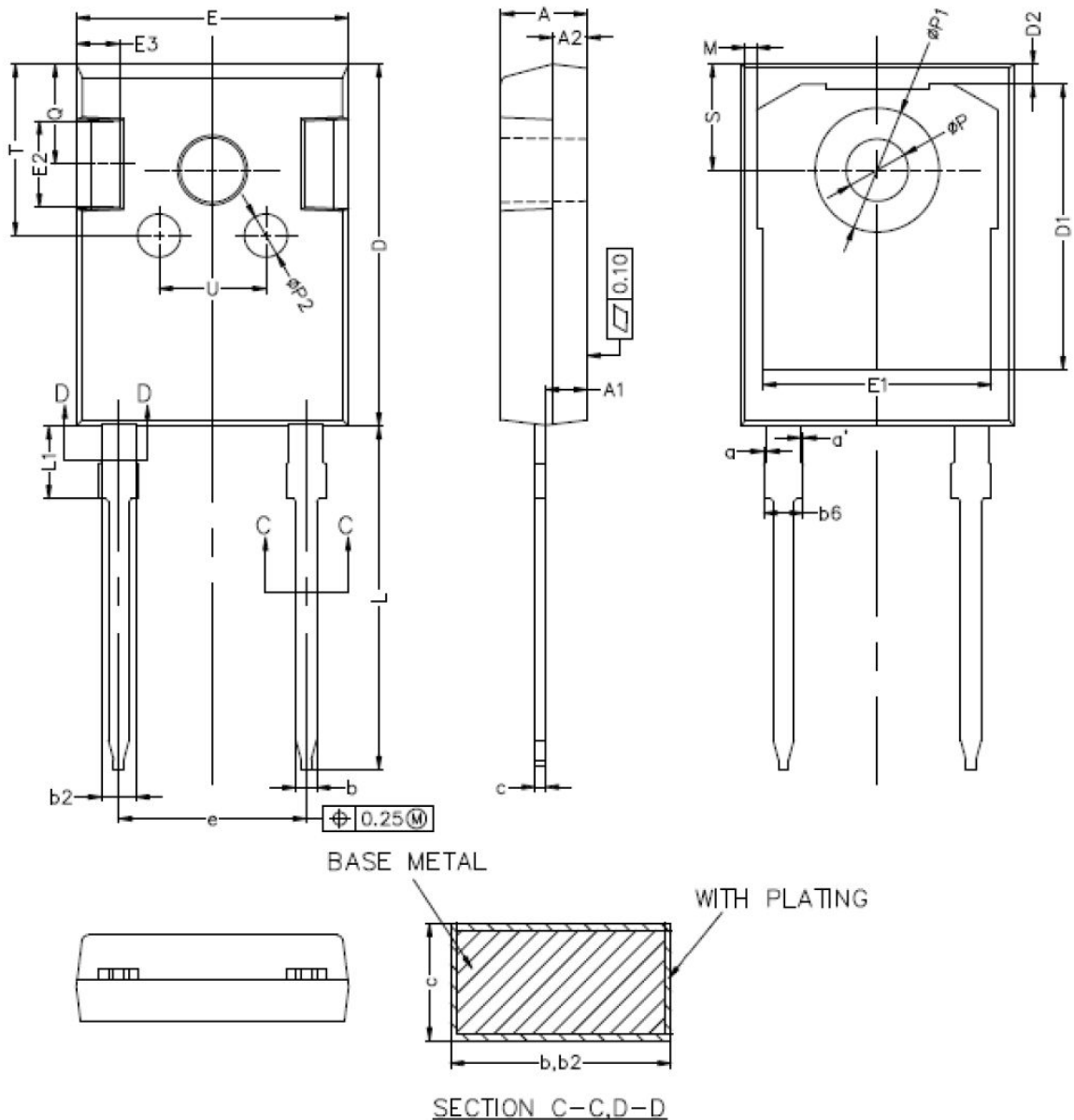

Note: This package drawing may slightly differ from the physical package. However, all the specified dimensions are guaranteed.

Table 6. DO-247 LL package mechanical data

Ref.	Dimensions					
	Millimeters			Inches (for reference only)		
	Min.	Typ.	Max.	Min.	Typ.	Max.
A	4.90	5.00	5.10	0.192	0.197	0.201
A1	2.31	2.41	2.51	0.090	0.095	0.099
A2	1.90	2.00	2.10	0.074	0.079	0.083
a	0.00		0.15	0.000		0.006
a'	0.00		0.15	0.000		0.006
b	1.16		1.29	0.045		0.051
b2	1.96		2.06	0.077		0.082
b6			2.25			0.089
c	0.59		0.66	0.023		0.026
D	20.90	21.00	21.10	0.822	0.827	0.831
D1	16.25	16.55	16.85	0.639	0.652	0.664
D2	1.05	1.20	1.35	0.041	0.047	0.054
E	15.70	15.80	15.90	0.618	0.622	0.626
E1	13.06	13.26	13.46	0.514	0.522	0.530
E2	4.90	5.00	5.10	0.192	0.197	0.201
E3	2.40	2.50	2.60	0.094	0.098	0.103
e	10.78	10.88	10.98	0.424	0.428	0.433
L	19.80	19.92	20.10	0.779	0.784	0.792
L1	3.93		4.46	0.154		0.176
M	0.35		0.95	0.013		0.038
P	3.50	3.60	3.70	0.137	0.142	0.146
P1	7.00		7.40	0.275		0.292
P2	2.40	2.50	2.60	0.094	0.098	0.103
Q	5.60		6.00	0.220		0.237
S	6.05	6.15	6.25	0.238	0.242	0.247
T	9.80		10.20	0.385		0.402
U	6.00		6.40	0.236		0.252

3 Ordering information

Table 7. Ordering information

Order code	Marking	Package	Weight	Base qty.	Delivery mode
STPSC20G065WLY	YSTPSC20G065WL	DO-247 LL	5.9 g	30	Tube

Revision history

Table 8. Document revision history

Date	Revision	Changes
06-Dec-2024	1	Initial release.

IMPORTANT NOTICE – READ CAREFULLY

STMicroelectronics NV and its subsidiaries (“ST”) reserve the right to make changes, corrections, enhancements, modifications, and improvements to ST products and/or to this document at any time without notice. Purchasers should obtain the latest relevant information on ST products before placing orders. ST products are sold pursuant to ST’s terms and conditions of sale in place at the time of order acknowledgment.

Purchasers are solely responsible for the choice, selection, and use of ST products and ST assumes no liability for application assistance or the design of purchasers’ products.

No license, express or implied, to any intellectual property right is granted by ST herein.

Resale of ST products with provisions different from the information set forth herein shall void any warranty granted by ST for such product.

ST and the ST logo are trademarks of ST. For additional information about ST trademarks, refer to www.st.com/trademarks. All other product or service names are the property of their respective owners.

Information in this document supersedes and replaces information previously supplied in any prior versions of this document.

© 2024 STMicroelectronics – All rights reserved