

## Long-life grade capacitors

### Applications

- Switch-mode power supplies in industrial and entertainment electronics
- Frequency converters

### Features

- Long useful life
- High reliability and high ripple current capability
- Low equivalent series resistance *ESR*
- High *CU* product, i.e. compact
- Different case sizes available for each capacitance value

### Construction

- Charge-discharge proof, polar
- Aluminum case, fully insulated
- Snap-in solder pins to hold component in place on PC-board
- Minus pole marking on case surface
- Minus pole not insulated from case
- Overload protection (safety vent)

### Terminals

- Standard version with 2 terminals  
2 lengths available: 6,3 and 4,5 mm
- 3 terminals: length 4,5 mm  
(terminal arrangement ensures correct insertion)

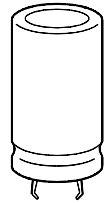

KAL0274-A

**Specifications and characteristics in brief**

|   |   |  |
|---|---|--|
| Rated voltage $U_R$   | 160 ... 450 VDC   |  |
| Surge voltage $U_S$   | $1,15 \cdot U_R$ (for $U_R \leq 250$ VDC)<br>$1,10 \cdot U_R$ (for $U_R \geq 385$ VDC)  |  |
| Rated capacitance $C_R$   | 47 ... 2 200 $\mu$ F  |  |
| Capacitance tolerance   | $\pm 20 \% \triangleq M$  |  |
| Leakage current $I_L$<br>(5 min, 20 °C)   | $I_L \leq 0,3 \mu A \cdot \left( \frac{C_R}{\mu F} \cdot \frac{U_R}{V} \right)^{0,7} + 4 \mu A$   |  |
| Self-inductance $L_{ESL}$   | Approx. 20 nH   |  |
| Useful life<br>85 °C; $U_R$ ; $I_{\sim R}$<br>40 °C; $U_R$ ; $1,4 \cdot I_{\sim R}$ | > 10 000 h<br>> 200 000 h   | <b>Requirements:</b><br>$\Delta C/C \leq \pm 30 \%$ of initial value<br>$ESR \leq 3$ times initial specified limit<br>$I_L \leq$ initial specified limit<br>Failure percentage: $\leq 1 \%$<br>Failure rate: $\leq 50$ fit ( $\leq 50 \cdot 10^{-9}/h$ )<br>(for definiton "fit", refer to chapter "Quality", page 62) |
| Voltage endurance test<br>85 °C; $U_R$  | 5 000 h   | <b>Post test requirements:</b><br>$\Delta C/C \leq \pm 10 \%$ of initial value<br>$ESR \leq 1,3$ times initial specified limit<br>$I_L \leq$ initial specified limit   |
| Vibration resistance  | To IEC 60068-2-6, test Fc:<br>displacement amplitude 0,35 mm, frequency range 10 ... 55 Hz,<br>acceleration max. 5 g, duration $3 \times 2$ h                       |  |
| IEC climatic category   | To IEC 60068-1:<br>$U_R \leq 400$ VDC: 40/085/56 (– 40 °C/+ 85 °C/56 days damp heat test)<br>$U_R \geq 420$ VDC: 25/085/56 (– 25 °C/+ 85 °C/56 days damp heat test) |  |
| Detail specification  | Similar to CECC 30301-811   |  |
| Sectional specification   | IEC 60384-4   |  |

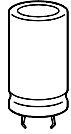
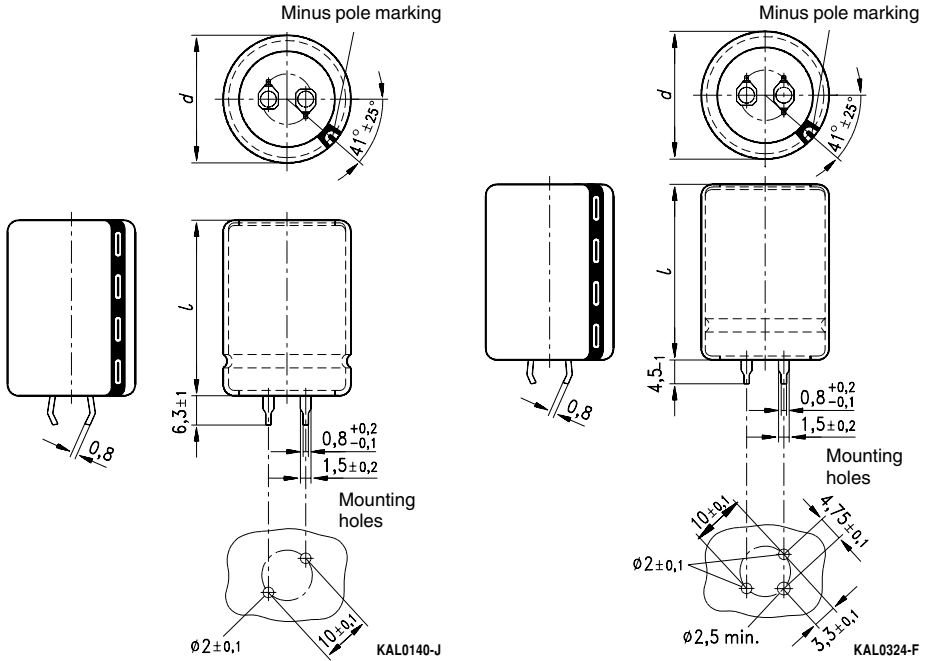
**Dimensional drawings**

Snap-in terminals, standard (length  $6,3 \pm 1$  mm). Also available in a shorter version with a length of  $4,5 - 1$  mm. For packing mode and ordering example see next page.

Snap-in capacitors are also available with 3 terminals (length  $4,5 - 1$  mm).

For packing mode and ordering example see next page.

| Dimensions (mm) |           | Approx. weight (g) | Packing units (pieces) |
|-----------------|-----------|--------------------|------------------------|
| $d + 1$         | $l \pm 2$ |                    |                        |
| 22              | 25        | 9                  | 160                    |
| 22              | 30        | 12                 | 160                    |
| 22              | 35        | 15                 | 160                    |
| 22              | 40        | 18                 | 160                    |
| 25              | 25        | 13                 | 130                    |
| 25              | 30        | 17                 | 130                    |
| 25              | 35        | 19                 | 130                    |
| 25              | 40        | 22                 | 130                    |

| Dimensions (mm) |           | Approx. weight (g) | Packing units (pieces) |
|-----------------|-----------|--------------------|------------------------|
| $d + 1$         | $l \pm 2$ |                    |                        |
| 30              | 25        | 17                 | 80                     |
| 30              | 30        | 23                 | 80                     |
| 30              | 35        | 29                 | 80                     |
| 30              | 40        | 36                 | 80                     |
| 30              | 45        | 41                 | 80                     |
| 30              | 50        | 47                 | 80                     |
| 35              | 35        | 36                 | 60                     |
| 35              | 40        | 41                 | 60                     |
| 35              | 45        | 57                 | 60                     |
| 35              | 50        | 72                 | 60                     |



B43501

Long Life – 85 °C

### Packing of snap-in capacitors



For ecological reasons the packing is pure cardboard. Components can be withdrawn (in full or in part) in the correct position for insertion.

### Ordering codes

| Snap-in terminals<br>Version    | Identification in 3rd block of ordering code |
|---------------------------------|--|
| Standard terminals (6,3 ± 1) mm | M000   |
| Short terminals (4,5 – 1) mm    | M007   |
| 3 terminals (4,5 – 1) mm        | M002   |

Ordering example:

B43501A3107M007 } snap-in capacitor with short terminals  
B43501A3107M002 } snap-in capacitor with 3 terminals

**Overview of available types**

| $U_R$ (VDC)      | 160                               | 200                | 250                | 385                | 400                | 420                | 450                           |
|------------------|-----------------------------------|--------------------|--------------------|--------------------|--------------------|--------------------|-------------------------------|
| $C_R$ ( $\mu$ F) | Case dimensions $d \times l$ (mm) |                    |                    |                    |                    |                    |                               |
| 47               |                                   |                    |                    |                    |                    |                    | 22 × 25                       |
| 68               |                                   |                    |                    | 22 × 25            | 22 × 25            |                    | 22 × 30<br>25 × 25            |
| 100              |                                   |                    |                    | 22 × 30<br>25 × 25 | 22 × 30<br>25 × 25 | 22 × 30<br>25 × 25 | 22 × 40<br>25 × 30<br>30 × 25 |
| 120              |                                   |                    |                    |                    | 22 × 35            | 25 × 30            |                               |
| 150              |                                   |                    | 22 × 25            | 22 × 40<br>25 × 30 | 22 × 40<br>30 × 25 | 22 × 40<br>25 × 35 | 25 × 40<br>30 × 30            |
| 180              |                                   |                    |                    |                    | 30 × 30            | 25 × 30<br>30 × 33 | 30 × 35                       |
| 220              | 22 × 25                           | 22 × 25            | 22 × 30<br>25 × 25 | 25 × 40<br>30 × 30 | 25 × 40<br>30 × 35 | 25 × 40<br>30 × 35 | 30 × 40                       |
| 270              |                                   |                    |                    |                    | 30 × 35            | 30 × 35<br>35 × 30 | 30 × 45                       |
| 330              | 22 × 30                           | 22 × 30<br>25 × 25 | 22 × 40<br>25 × 30 | 30 × 40            | 30 × 45            | 30 × 45<br>35 × 35 | 35 × 40                       |
| 390              |                                   |                    |                    |                    | 30 × 50            | 30 × 50            |                               |
| 470              | 22 × 35                           | 22 × 40<br>30 × 25 | 25 × 40<br>30 × 30 | 35 × 40            | 35 × 45            | 35 × 45            | 35 × 50                       |
| 560              |                                   |                    |                    | 35 × 45            | 35 × 50            | 35 × 50            |                               |
| 680              | 25 × 35                           | 25 × 40<br>30 × 30 | 30 × 40            |                    |                    |                    |                               |
| 1 000            | 30 × 35                           | 30 × 40<br>35 × 35 | 35 × 40            |                    |                    |                    |                               |
| 1 500            | 30 × 45                           | 35 × 45            |                    |                    |                    |                    |                               |
| 2 200            | 35 × 50                           |                    |                    |                    |                    |                    |                               |

The capacitance and voltage ratings listed above are available in different cases upon request. Other voltage and capacitance ratings are also available upon request.

**Technical data and ordering codes**

| $U_R$ | $C_R$<br>100 Hz<br>20 °C<br>μF | Case<br>dimensions<br>$d \times l$<br>mm | $ESR_{typ}$<br>100 Hz<br>20 °C<br>mΩ | $ESR_{max}$<br>100 Hz<br>20 °C<br>mΩ | $Z_{max}$<br>10 kHz<br>20 °C<br>mΩ | $I_{~max}$<br>100 Hz<br>40 °C<br>A | $I_{~R}^{(1)}$<br>100 Hz<br>85 °C<br>A | Ordering code <sup>2)</sup> |
|-------|--------------------------------|--|--------------------------------------|--------------------------------------|------------------------------------|------------------------------------|--|-----------------------------|
| 160   | 220                            | 22 × 25                                  | 530                                  | 910                                  | 730                                | 2,4                                | 1,1                                    | B43501A1227M000             |
|       | 330                            | 22 × 30                                  | 360                                  | 610                                  | 490                                | 3,2                                | 1,4                                    | B43501A1337M000             |
|       | 470                            | 22 × 35                                  | 250                                  | 430                                  | 350                                | 4,0                                | 1,8                                    | B43501A1477M000             |
|       | 680                            | 25 × 35                                  | 180                                  | 300                                  | 240                                | 5,2                                | 2,4                                    | B43501A1687M000             |
|       | 1 000                          | 30 × 35                                  | 120                                  | 200                                  | 160                                | 6,9                                | 3,1                                    | B43501A1108M000             |
|       | 1 500                          | 30 × 45                                  | 80                                   | 140                                  | 120                                | 9,2                                | 4,2                                    | B43501A1158M000             |
|       | 2 200                          | 35 × 50                                  | 60                                   | 91                                   | 80                                 | 13                                 | 5,8                                    | B43501A1228M000             |
| 200   | 220                            | 22 × 25                                  | 380                                  | 610                                  | 490                                | 2,4                                | 1,1                                    | B43501A2227M000             |
|       | 330                            | 22 × 30                                  | 260                                  | 410                                  | 330                                | 3,2                                | 1,4                                    | B43501A2337M000             |
|       | 330                            | 25 × 25                                  | 260                                  | 410                                  | 330                                | 3,2                                | 1,5                                    | B43501J2337M000             |
|       | 470                            | 22 × 40                                  | 180                                  | 290                                  | 240                                | 4,2                                | 1,9                                    | B43501A2477M000             |
|       | 470                            | 30 × 25                                  | 180                                  | 290                                  | 350                                | 4,2                                | 1,9                                    | B43501J2477M000             |
|       | 680                            | 25 × 40                                  | 130                                  | 200                                  | 160                                | 5,5                                | 2,5                                    | B43501A2687M000             |
|       | 680                            | 30 × 30                                  | 130                                  | 200                                  | 160                                | 5,4                                | 2,4                                    | B43501J2687M000             |
|       | 1 000                          | 30 × 40                                  | 83                                   | 140                                  | 120                                | 7,2                                | 3,3                                    | B43501A2108M000             |
|       | 1 000                          | 35 × 35                                  | 83                                   | 140                                  | 120                                | 7,6                                | 3,5                                    | B43501J2108M000             |
|       | 1 500                          | 35 × 45                                  | 56                                   | 90                                   | 80                                 | 10                                 | 4,6                                    | B43501A2158M000             |
|       | 250                            | 150                                      | 22 × 25                              | 560                                  | 890                                | 800                                | 2,0                                    | 0,91                        |
| 220   |                                | 22 × 30                                  | 380                                  | 610                                  | 500                                | 2,6                                | 1,2                                    | B43501B2227M000             |
| 220   |                                | 25 × 25                                  | 380                                  | 610                                  | 490                                | 2,6                                | 1,2                                    | B43501K2227M000             |
| 330   |                                | 22 × 40                                  | 260                                  | 410                                  | 330                                | 3,5                                | 1,6                                    | B43501B2337M000             |
| 330   |                                | 25 × 30                                  | 260                                  | 410                                  | 330                                | 3,4                                | 1,6                                    | B43501K2337M000             |
| 470   |                                | 25 × 40                                  | 180                                  | 290                                  | 240                                | 4,5                                | 2,1                                    | B43501B2477M000             |
| 470   |                                | 30 × 30                                  | 180                                  | 290                                  | 240                                | 4,5                                | 2,0                                    | B43501K2477M000             |
| 680   |                                | 30 × 40                                  | 130                                  | 200                                  | 160                                | 5,9                                | 2,7                                    | B43501B2687M000             |
| 1 000 |                                | 35 × 40                                  | 83                                   | 140                                  | 120                                | 8,0                                | 3,6                                    | B43501B2108M000             |

Preferred types

1) 120 Hz conversion factor of ripple current:  $I_{~}(120 \text{ Hz}) = 1,03 \cdot I_{~}(100 \text{ Hz})$

2) Ordering code for standard terminals (6,3 mm).

To determine the ordering code for short terminals (4,5 mm) and 3 terminals (4,5 mm) see page 238.

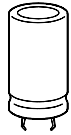

| $U_R$ | $C_R$<br>100 Hz<br>20 °C | Case<br>dimensions<br>$d \times l$<br>mm | $ESR_{typ}$<br>100 Hz<br>20 °C<br>mΩ | $ESR_{max}$<br>100 Hz<br>20 °C<br>mΩ | $Z_{max}$<br>10 kHz<br>20 °C<br>mΩ | $I_{~max}$<br>100 Hz<br>40 °C<br>A | $I_{~R}^{(1)}$<br>100 Hz<br>85 °C<br>A | Ordering code <sup>2)</sup> |
|-------|--------------------------|--|--------------------------------------|--------------------------------------|------------------------------------|------------------------------------|--|-----------------------------|
| VDC   | μF                       |  |                                      |                                      |                                    |                                    |  |                             |
| 385   | 68                       | 22 × 25                                  | 980                                  | 1960                                 | 1570                               | 1,3                                | 0,61                                   | B43501A3686M000             |
|       | 100                      | 22 × 30                                  | 670                                  | 1330                                 | 1070                               | 1,7                                | 0,79                                   | B43501A3107M000             |
|       | 100                      | 25 × 25                                  | 670                                  | 1330                                 | 1070                               | 1,8                                | 0,80                                   | B43501B3107M000             |
|       | 150                      | 22 × 40                                  | 450                                  | 890                                  | 720                                | 2,4                                | 1,1                                    | B43501A3157M000             |
|       | 150                      | 25 × 30                                  | 450                                  | 890                                  | 720                                | 2,3                                | 1,0                                    | B43501B3157M000             |
|       | 220                      | 25 × 40                                  | 310                                  | 610                                  | 490                                | 3,1                                | 1,4                                    | B43501A3227M000             |
|       | 220                      | 30 × 30                                  | 310                                  | 610                                  | 490                                | 3,1                                | 1,4                                    | B43501B3227M000             |
|       | 330                      | 30 × 40                                  | 210                                  | 410                                  | 330                                | 4,1                                | 1,9                                    | B43501A3337M000             |
|       | 470                      | 35 × 40                                  | 150                                  | 290                                  | 240                                | 5,5                                | 2,5                                    | B43501A3477M000             |
|       | 560                      | 35 × 45                                  | 120                                  | 240                                  | 200                                | 6,2                                | 2,8                                    | B43501A3567M000             |
| 400   | 68                       | 22 × 25                                  | 980                                  | 1960                                 | 1570                               | 1,3                                | 0,61                                   | B43501A9686M000             |
|       | 100                      | 22 × 30                                  | 670                                  | 1330                                 | 1070                               | 1,7                                | 0,79                                   | B43501A9107M000             |
|       | 100                      | 25 × 25                                  | 670                                  | 1330                                 | 1070                               | 1,8                                | 0,80                                   | B43501B9107M000             |
|       | 120                      | 22 × 35                                  | 560                                  | 1100                                 | 890                                | 2,0                                | 0,92                                   | B43501A9127M000             |
|       | 150                      | 22 × 40                                  | 450                                  | 890                                  | 720                                | 2,4                                | 1,1                                    | B43501A9157M000             |
|       | 150                      | 30 × 25                                  | 450                                  | 890                                  | 720                                | 2,4                                | 1,1                                    | B43501B9157M000             |
|       | 180                      | 30 × 30                                  | 370                                  | 740                                  | 600                                | 2,7                                | 1,2                                    | B43501A9187M000             |
|       | 220                      | 25 × 40                                  | 310                                  | 610                                  | 490                                | 3,1                                | 1,4                                    | B43501A9227M000             |
|       | 220                      | 30 × 35                                  | 310                                  | 610                                  | 490                                | 3,2                                | 1,5                                    | B43501B9227M000             |
|       | 270                      | 30 × 35                                  | 250                                  | 490                                  | 400                                | 3,5                                | 1,6                                    | B43501A9277M000             |
|       | 330                      | 30 × 45                                  | 210                                  | 410                                  | 330                                | 4,3                                | 2,0                                    | B43501A9337M000             |
|       | 390                      | 30 × 50                                  | 180                                  | 340                                  | 280                                | 4,8                                | 2,2                                    | B43501A9397M000             |
|       | 470                      | 35 × 45                                  | 150                                  | 290                                  | 240                                | 5,7                                | 2,6                                    | B43501A9477M000             |
|       | 560                      | 35 × 50                                  | 120                                  | 240                                  | 200                                | 6,4                                | 2,9                                    | B43501A9567M000             |

Preferred types

1) 120 Hz conversion factor of ripple current:  $I_{~}(120 \text{ Hz}) = 1,03 \cdot I_{~}(100 \text{ Hz})$

2) Ordering code for standard terminals (6,3 mm).

To determine the ordering code for short terminals (4,5 mm) and 3 terminals (4,5 mm) see page 238.

**B43501**
**Long Life – 85 °C**

| $U_R$ | $C_R$<br>100 Hz<br>20 °C | Case<br>dimensions<br>$d \times l$<br>mm | $ESR_{typ}$<br>100 Hz<br>20 °C<br>mΩ | $ESR_{max}$<br>100 Hz<br>20 °C<br>mΩ | $Z_{max}$<br>10 kHz<br>20 °C<br>mΩ | $I_{~max}$<br>100 Hz<br>40 °C<br>A | $I_{~R^{(1)}}$<br>100 Hz<br>85 °C<br>A | Ordering code <sup>2)</sup> |                 |
|-------|--------------------------|--|--------------------------------------|--------------------------------------|------------------------------------|------------------------------------|--|-----------------------------|-----------------|
| VDC   | 420                      | 100                                      | 22 × 30                              | 1330                                 | 1990                               | 1600                               | 1,74                                   | 0,79                        | B43501A0107M000 |
|       |                          | 100                                      | 25 × 25                              | 1330                                 | 1990                               | 1600                               | 1,77                                   | 0,80                        | B43501E0107M000 |
|       |                          | 120                                      | 22 × 30                              | 1110                                 | 1660                               | 1330                               | 2,06                                   | 0,94                        | B43501A0127M000 |
|       |                          | 150                                      | 22 × 40                              | 890                                  | 1330                               | 1070                               | 2,37                                   | 1,08                        | B43501A0157M000 |
|       |                          | 150                                      | 25 × 35                              | 890                                  | 1330                               | 1070                               | 2,44                                   | 1,11                        | B43501E0157M000 |
|       |                          | 180                                      | 25 × 35                              | 740                                  | 1110                               | 890                                | 2,67                                   | 1,21                        | B43501A0187M000 |
|       |                          | 180                                      | 30 × 30                              | 740                                  | 1110                               | 890                                | 2,76                                   | 1,26                        | B43501E0187M000 |
|       |                          | 220                                      | 25 × 40                              | 610                                  | 910                                | 730                                | 3,11                                   | 1,41                        | B43501A0227M000 |
|       |                          | 220                                      | 30 × 35                              | 610                                  | 910                                | 730                                | 3,22                                   | 1,46                        | B43501E0227M000 |
|       |                          | 270                                      | 30 × 35                              | 500                                  | 740                                | 590                                | 3,57                                   | 1,62                        | B43501A0277M000 |
|       |                          | 270                                      | 35 × 30                              | 500                                  | 740                                | 590                                | 3,76                                   | 1,71                        | B43501E0277M000 |
|       |                          | 330                                      | 30 × 45                              | 410                                  | 610                                | 490                                | 4,32                                   | 1,96                        | B43501A0337M000 |
|       |                          | 330                                      | 35 × 35                              | 410                                  | 610                                | 490                                | 4,37                                   | 1,98                        | B43501E0337M000 |
|       |                          | 390                                      | 30 × 50                              | 350                                  | 520                                | 410                                | 4,89                                   | 2,22                        | B43501A0397M000 |
|       |                          | 470                                      | 35 × 45                              | 290                                  | 430                                | 340                                | 5,69                                   | 2,58                        | B43501A0477M000 |
|       |                          | 560                                      | 35 × 50                              | 240                                  | 360                                | 290                                | 6,45                                   | 2,93                        | B43501A0567M000 |
| VDC   | 450                      | 47                                       | 22 × 25                              | 2830                                 | 4240                               | 3400                               | 1,1                                    | 0,51                        | B43501A5476M000 |
|       |                          | 68                                       | 22 × 30                              | 1960                                 | 2930                               | 2350                               | 1,4                                    | 0,65                        | B43501A5686M000 |
|       |                          | 68                                       | 25 × 25                              | 1960                                 | 2930                               | 2350                               | 1,5                                    | 0,66                        | B43501B5686M000 |
|       |                          | 100                                      | 22 × 40                              | 1330                                 | 1990                               | 1600                               | 1,9                                    | 0,88                        | B43501A5107M000 |
|       |                          | 100                                      | 25 × 30                              | 1330                                 | 1990                               | 1600                               | 1,9                                    | 0,86                        | B43501B5107M000 |
|       |                          | 100                                      | 30 × 25                              | 1330                                 | 1990                               | 1600                               | 1,9                                    | 0,90                        | B43501C5107M000 |
|       |                          | 150                                      | 25 × 40                              | 890                                  | 1330                               | 1070                               | 2,6                                    | 1,2                         | B43501A5157M000 |
|       |                          | 150                                      | 30 × 30                              | 890                                  | 1330                               | 1070                               | 2,5                                    | 1,1                         | B43501B5157M000 |
|       |                          | 180                                      | 30 × 35                              | 750                                  | 1100                               | 890                                | 2,9                                    | 1,3                         | B43501A5187M000 |
|       |                          | 220                                      | 30 × 40                              | 610                                  | 910                                | 730                                | 3,4                                    | 1,5                         | B43501A5227M000 |
|       |                          | 270                                      | 30 × 45                              | 500                                  | 740                                | 600                                | 3,9                                    | 1,8                         | B43501A5277M000 |
|       |                          | 330                                      | 35 × 40                              | 410                                  | 610                                | 490                                | 4,6                                    | 2,1                         | B43501A5337M000 |
|       |                          | 470                                      | 35 × 50                              | 290                                  | 430                                | 350                                | 5,9                                    | 2,7                         | B43501A5477M000 |

Preferred types

1) 120 Hz conversion factor of ripple current:  $I_{~(120\text{ Hz})} = 1,03 \cdot I_{~(100\text{ Hz})}$

2) Ordering code for standard terminals (6,3 mm).

To determine the ordering code for short terminals (4,5 mm) and 3 terminals (4,5 mm) see page 238.

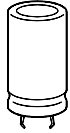

**Useful life**

depending on ambient temperature  $T_A$  under ripple current operating conditions<sup>1)</sup>

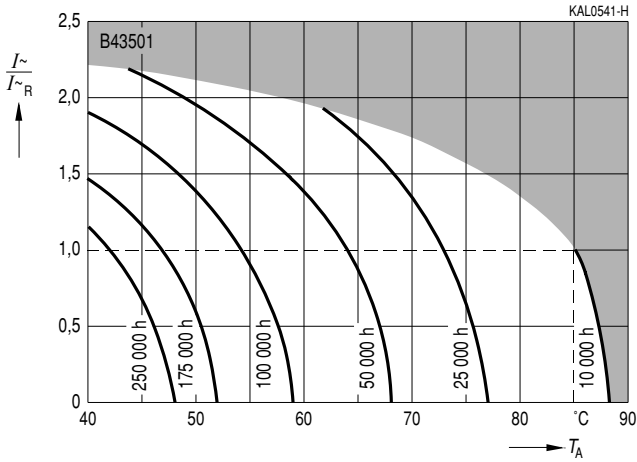

**Frequency factor of permissible ripple current  $I_{\sim}$  versus frequency  $f$**

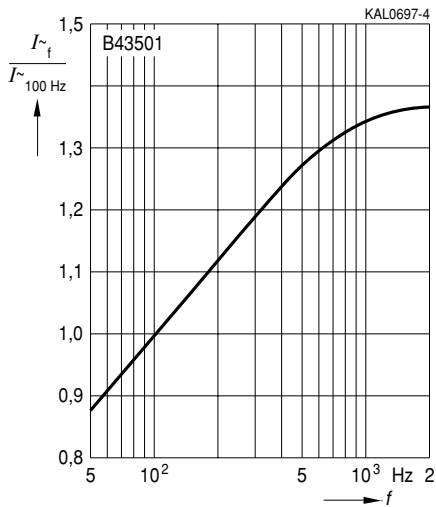

1) Refer to page 40 for an explanation on how to interpret the useful life graphs.

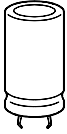

**B43501**

**Long Life – 85 °C**

**Frequency characteristics of ESR**

Typical behavior

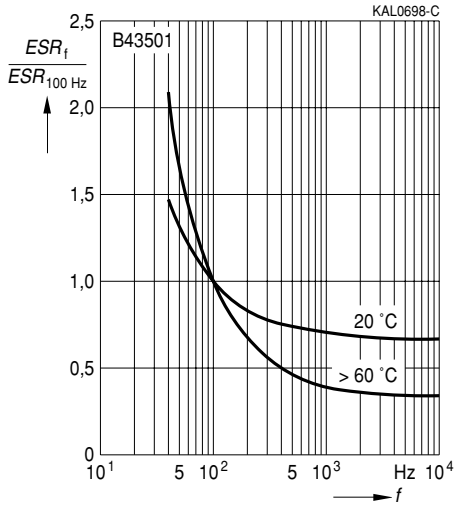

**Impedance Z**

versus frequency  $f$

Typical behavior at 20 °C

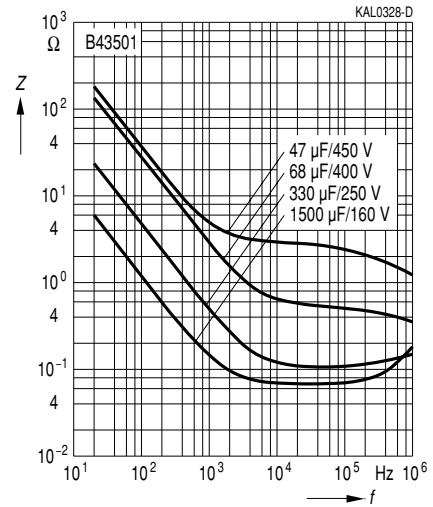

**Herausgegeben von EPCOS AG**

**Unternehmenskommunikation, Postfach 80 17 09, 81617 München, DEUTSCHLAND**

**☎ ++49 89 636 09, FAX (0 89) 636-2 26 89**

© EPCOS AG 2002. Vervielfältigung, Veröffentlichung, Verbreitung und Verwertung dieser Broschüre und ihres Inhalts ohne ausdrückliche Genehmigung der EPCOS AG nicht gestattet.

Bestellungen unterliegen den vom ZVEI empfohlenen Allgemeinen Lieferbedingungen für Erzeugnisse und Leistungen der Elektroindustrie, soweit nichts anderes vereinbart wird.

Diese Broschüre ersetzt die vorige Ausgabe.

Fragen über Technik, Preise und Liefermöglichkeiten richten Sie bitte an den Ihnen nächstgelegenen Vertrieb der EPCOS AG oder an unsere Vertriebsgesellschaften im Ausland. Bauelemente können aufgrund technischer Erfordernisse Gefahrstoffe enthalten. Auskünfte darüber bitten wir unter Angabe des betreffenden Typs ebenfalls über die zuständige Vertriebsgesellschaft einzuholen.

**Published by EPCOS AG**

**Corporate Communications, P.O. Box 80 17 09, 81617 Munich, GERMANY**

**☎ ++49 89 636 09, FAX (0 89) 636-2 26 89**

© EPCOS AG 2002. Reproduction, publication and dissemination of this brochure and the information contained therein without EPCOS' prior express consent is prohibited.

Purchase orders are subject to the General Conditions for the Supply of Products and Services of the Electrical and Electronics Industry recommended by the ZVEI (German Electrical and Electronic Manufacturers' Association), unless otherwise agreed.

This brochure replaces the previous edition.

For questions on technology, prices and delivery please contact the Sales Offices of EPCOS AG or the international Representatives.

Due to technical requirements components may contain dangerous substances. For information on the type in question please also contact one of our Sales Offices.