

# High Capacitance Supercapacitors



**ADCS-E02R7S**

Request Samples



Check Inventory



Various Sizes

RoHS/RoHS II Compliant

MSL Level = N/A

## Features

- High Energy density up to 6Wh/Kg
- Low Leakage Current as small as 1.7mA
- Low Self-discharge rate, 72 hours @ discharge <5%
- Excellent cycle life of >500K cycles @ 25C
- Green, meet RoHS requirements.

## Applications

- Power Assist Circuits
- Power Backup
- Micro Energy Storage
- IoT Energy Harvesting
- SSD applications
- DDR power back up
- RTC System power transfer to battery backup

## Electrical Specifications

Part Numbers*	Rated Voltage (U <sub>R</sub> )	Surge Voltage (Max)	Capacitance	Tolerance	ESR (Max)		Continuous Current (Max)	Peak Current (Max)	Leakage Current	Stored Energy (Max)	Gravimetric Energy Density
	DC (V)	DC (V)	Farads	See part number identifier	AC ESR (mΩ)	DC ESR (mΩ)	A	A	mA	Wh	Wh/kg
ADCS-E02R7SA657	2.7	2.85	650	Q, M	0.60	0.72	54	598	1.70	0.6581	4.11
ADCS-E02R7SA128	2.7	2.85	1200	Q, M	0.40	0.55	70	976	2.80	1.2150	4.67
ADCS-E02R7SA158	2.7	2.85	1500	Q, M	0.33	0.45	84	1209	3.00	1.5188	5.42
ADCS-E02R7SA208	2.7	2.85	2000	Q, M	0.25	0.35	110	1588	4.20	2.0250	5.63
ADCS-E02R7SA308	2.7	2.85	3000	Q, M	0.22	0.26	130	2275	5.20	3.0375	6.08

\*For full part numbers, refer to the part number identification section

**Operating Temperature:** -40°C to +65°C.

**Storage Temperature:** 10°C to +40°C, Max. Humidity <85% RH.

**Test Conditions:** +25°C.

All parameters are measured according to the IEC 62813 standard.

Capacitance and ESR are measured with  $I(\text{mA}) = 4(C \cdot U_R)$

**Continuous Current (Max):** DC current at which the body temperature rises by  $\Delta T = 15^\circ\text{C}$ .

**Leakage Current:** Measured after 72h at Rated Voltage (U<sub>R</sub>)



5101 Hidden Creek Ln, Spicewood TX 78669  
 Phone: 512-371-6159 Fax: 512-351-8858  
 For terms and conditions of sales, please visit:  
[www.abracon.com](http://www.abracon.com)

**REVISION Initial Release :**  
 3/7/2025

ABRACON IS  
 ISO9001-2015  
 CERTIFIED

# High Capacitance Supercapacitors

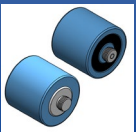

**ADCS-E02R7S**

Request Samples



Check Inventory



Various Sizes

RoHS/RoHS II Compliant

MSL Level = N/A

## Mechanical Specifications

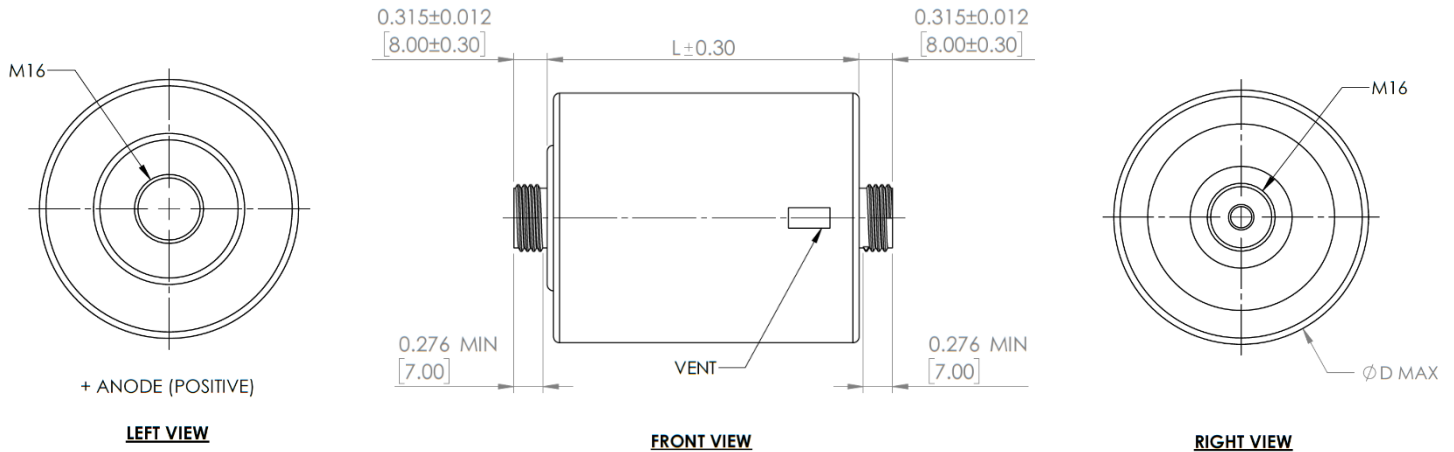

Dimensions	$\varnothing D$	L
ADCS-E02R7SA657	2.362[60]	2.165[55]
ADCS-E02R7SA128	2.362[60]	2.952[75]
ADCS-E02R7SA158	2.362[60]	3.346[85]
ADCS-E02R7SA208	2.362[60]	4.133[105]
ADCS-E02R7SA308	2.362[60]	5.511[140]

**Dimensions: Inches [mm]**

# High Capacitance Supercapacitors

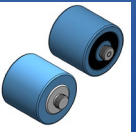

**ADCS-E02R7S**

Request Samples



Check Inventory



Various Sizes

RoHS/RoHS II Compliant

MSL Level = N/A

## Part Number Identification

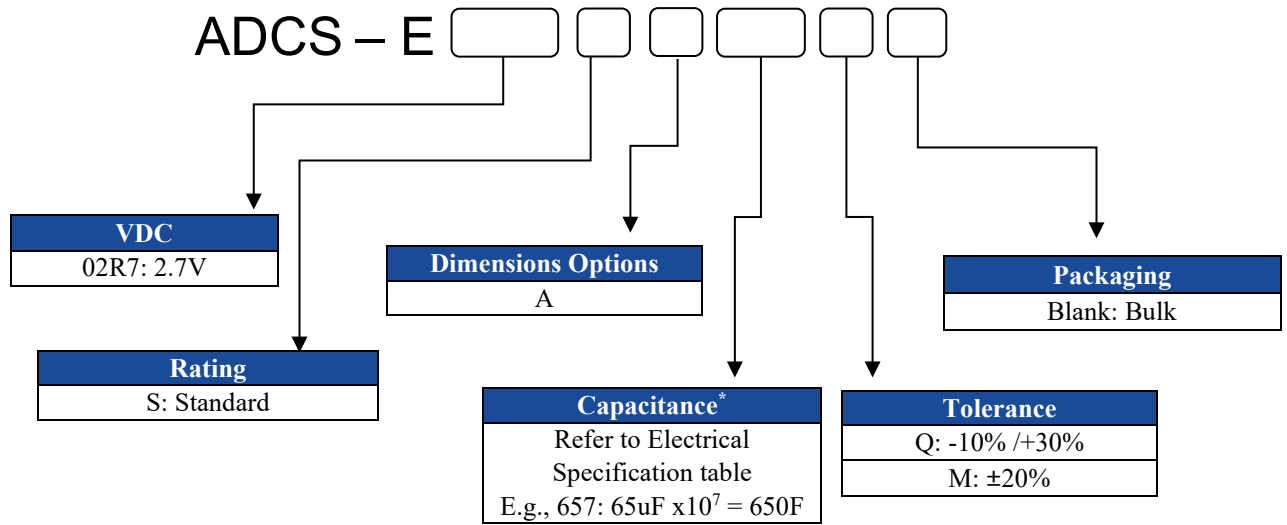

\*Only part numbers listed in the Electrical Specs table are available. For custom builds, please contact us.



5101 Hidden Creek Ln, Spicewood TX 78669  
 Phone: 512-371-6159 Fax: 512-351-8858  
 For terms and conditions of sales, please visit:  
[www.abracon.com](http://www.abracon.com)

**REVISION Initial Release :**  
 3/7/2025

ABRACON IS  
 ISO9001-2015  
 CERTIFIED

# High Capacitance Supercapacitors

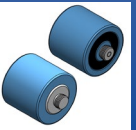

ADCS-E02R7S

Request Samples



Check Inventory



Various Sizes

RoHS/RoHS II Compliant

MSL Level = N/A

## Wave Profile

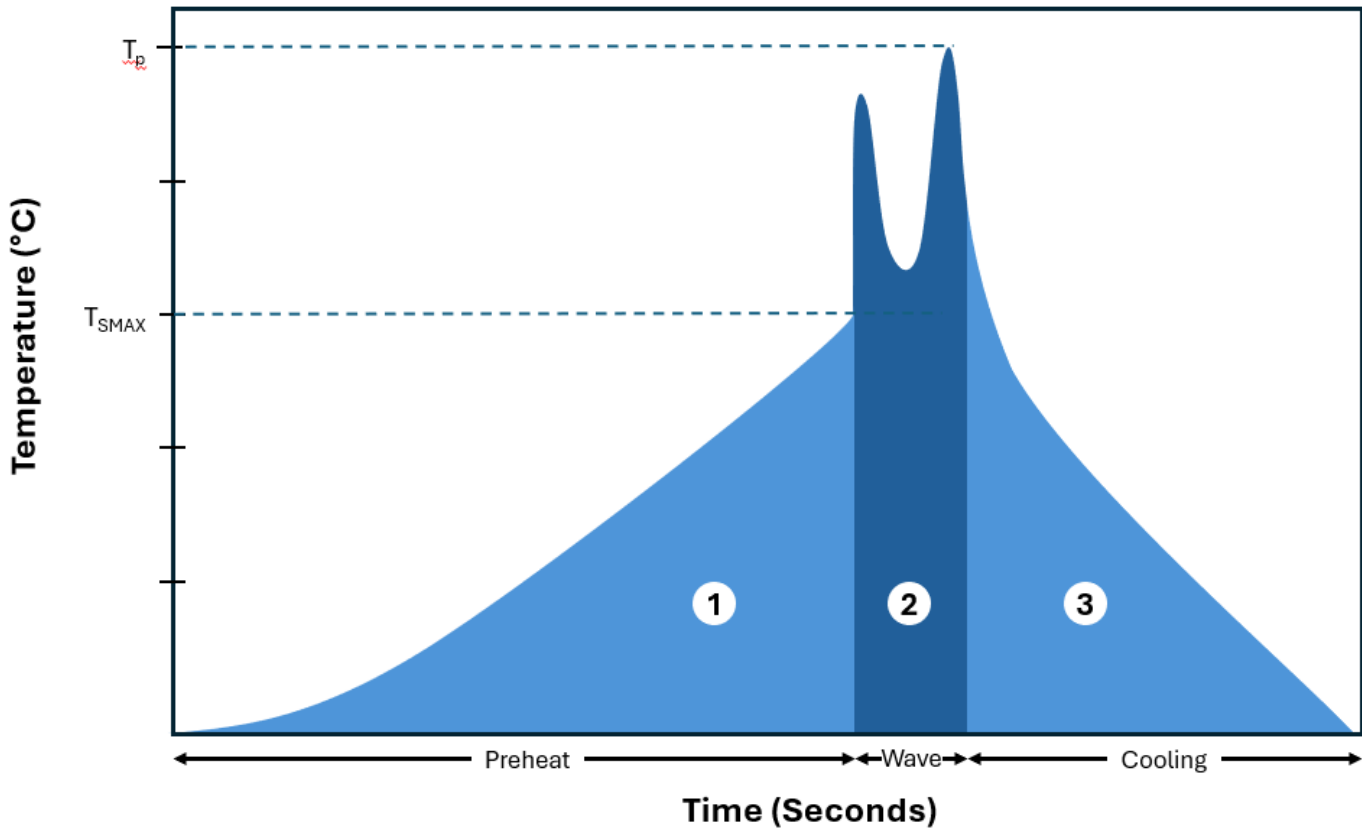

Zone	Description	Temperature	Times
1	Preheat	$T_{SMIN} \sim T_{SMAX}$ 25°C ~ 130°C	80 sec. MAX
	Preheat Rate	$T_{PREHEAT}$ +4°C/Sec MAX	
2	Wave Temperature	$T_w$ 245°C ~ 260°C	10 sec. MAX Dual wave
	Wave Peak Temperature	$T_p$ 260°C	5 sec. MAX/wave
3	Cooling Rate	$T_{COOLING}$	-5°C/Sec MAX

# High Capacitance Supercapacitors

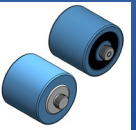

**ADCS-E02R7S**

Request Samples



Check Inventory



Various Sizes

RoHS/RoHS II Compliant

MSL Level = N/A

## Packaging

The product is packaged in a carton containing multiple inner boxes as follows:

Part Number	Pcs/Box
ADCS-E02R7SA657	50
ADCS-E02R7SA128	50
ADCS-E02R7SA158	50
ADCS-E02R7SA208	25
ADCS-E02R7SA308	25

## Transport of Product

This product is not subject to US DOT or IATA regulations UN3499 since maximum stored energy is below 10Wh and can be considered Non-Hazardous Goods.

**ATTENTION:** Abracon LLC's products are Commercial-Off-The-Shelf (COTS, which are designed, intended and validated for use in commercial, industrial and automotive applications. The customer is responsible for testing and verifying the performance of an Abracon solution to meet their system-level requirements.



5101 Hidden Creek Ln, Spicewood TX 78669  
Phone: 512-371-6159 Fax: 512-351-8858  
For terms and conditions of sales, please visit:  
[www.abracon.com](http://www.abracon.com)

**REVISION Initial Release :**  
3/7/2025

ABRACON IS  
ISO9001-2015  
CERTIFIED