

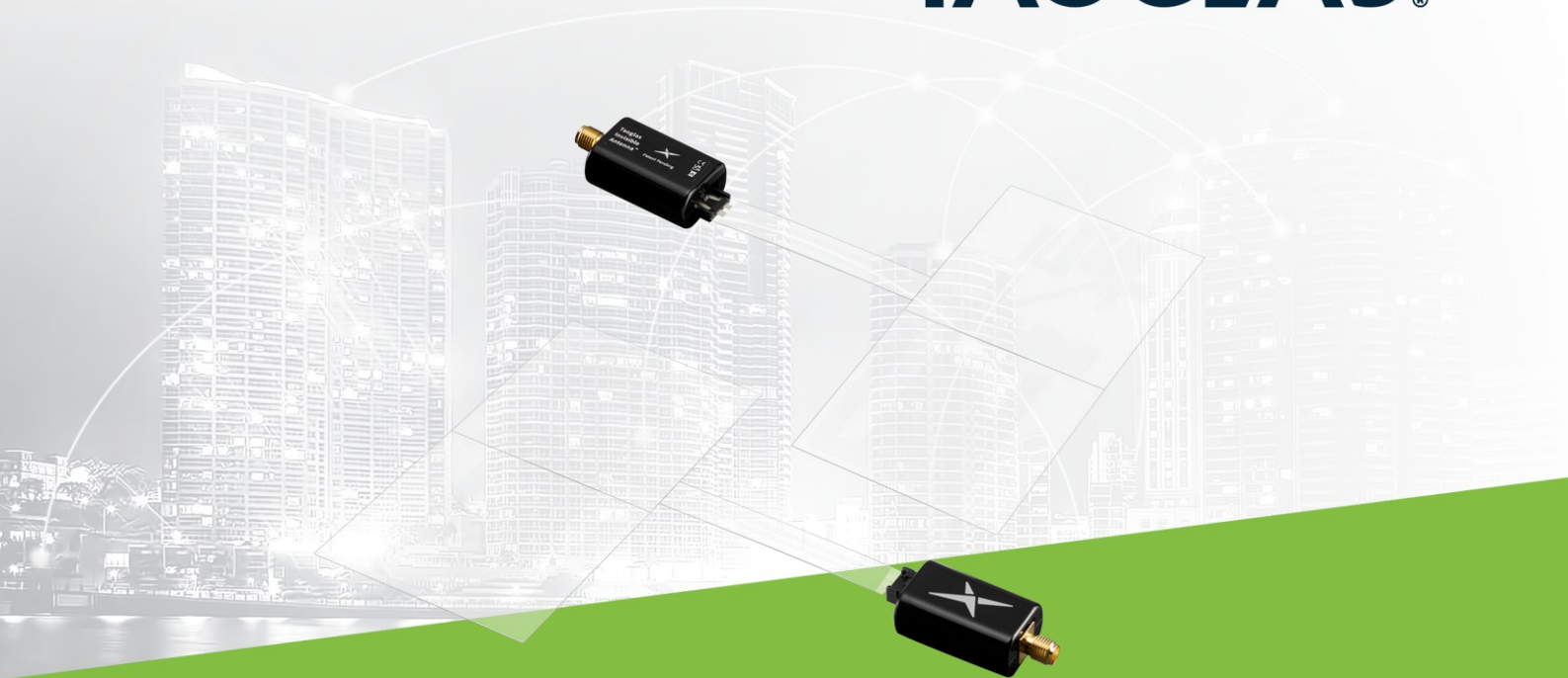

TAOGLAS®



Datasheet

Taoglas Invisible Antenna™

Part No:
TFX62.C

Description

TFX62.C - Cellular Invisible Antenna

Features:

- 600-6000MHz
- Worldwide 5G/4G Bands
- Efficiencies up to 60%
- Transparent Ultra Low Profile
- Dims: 110mm * 160mm
- Connector: SMA (F)
- RoHS & Reach Compliant

| | | |
|-----------|--------------------------------|-----------|
| 1. | Introduction | 3 |
| 2. | Specification | 4 |
| 3. | Mechanical Drawing | 6 |
| 4. | Packaging | 7 |
| 5. | Antenna Characteristics | 8 |
| 6. | Radiation Patterns | 12 |
| <hr/> | | |
| | Changelog | 21 |

Taoglas makes no warranties based on the accuracy or completeness of the contents of this document and reserves the right to make changes to specifications and product descriptions at any time without notice. Taoglas reserves all rights to this document and the information contained herein. Reproduction, use or disclosure to third parties without express permission is strictly prohibited.

Ireland & USA
ISO 9001:2015
Certified



Taiwan
ISO 9001:2015
Certified



1. Introduction



The TFX62 is a first of its kind, invisible antenna designed to cover worldwide 4G bands from 600-6000MHz. The TFX62 has been expertly engineered by Taoglas with innovation in mind, the design is based on our excellent design history in pioneering flexible PCB antenna technology. TFX62 is supplied with pre adhered adhesive for ease of installation and has an enclosed carrier terminated with a SMA connector.

The transparent flexible antennas are an alternative to standard Flexible PCB antennas where the user may want to install an antenna in a covert area or on a surface, they may want to keep visible. The performance of the antenna is based on the environment where it is placed, care should be taken to mount at least 20mm from metal components where possible.

Typical Applications Include:

- Automotive and Commercial Transportation
- EV Charging and Parking Bays
- Digital Signage and Display screens
- Point Of Sale Kiosks

The installation of the TFX series follows a similar installation method to flexible PCB antennas. Installing a transparent material may show obvious flaws/debris, take care to wipe the area clean before adhering the antenna. The flexible antenna can be disconnected from the body to make installation easier. Where support may be an issue, we would advise using a double-sided adhesive on the housing to ensure the housing body installation does not add any additional pull force to the antenna as this will affect the antennas performance and the adhesive's performance. The feed is not designed to be load bearing and loads of over 0.5Kg can break or damage the feed resulting in the antenna disconnecting.

The TFX62 is connected via a SMA female connector for ease of installation. If a custom connector is required, please contact your regional Taoglas customer support team.

2. Specification

| LTE Electrical | | | | | | | | |
|--|-----------------|----------------|-------------------|-----------------|-----------|--------------|-------------------|------------------|
| Band | Frequency (MHz) | Efficiency (%) | Average Gain (dB) | Peak Gain (dBi) | Impedance | Polarization | Radiation Pattern | Max. input power |
| 5GNR/4G Band 71 | 617-698 | 13.3 | -8.76 | -5.35 | 50 Ω | Linear | Omni | 2W |
| 4G/3G Band 12,13,14,17,28,29 | 698-806 | 22.4 | -6.50 | -1.16 | | | | |
| 4G/3G/NB-IoT/Cat M Band 5,8,18,19,20,26,27 | 824-960 | 35.7 | -4.48 | 0.35 | | | | |
| 5GNR/4G Band 21,32,74,75,76 | 1427-1518 | 39.1 | -4.07 | 1.40 | | | | |
| 4G/3G Band 1,2,3,4,9,23,25,35,39,66 | 1710-2200 | 50.6 | -2.95 | 2.19 | | | | |
| 4G/3G Band 7,30,38,40,41 | 2300-2690 | 52.6 | -2.79 | 2.63 | | | | |
| 5GNR/4G Band 22,42,48,77,78,79 | 3300-5000 | 54.9 | -2.61 | 6.29 | | | | |
| LTE5200/Wi-Fi5800 | 5150-5925 | 39.1 | -4.08 | 3.70 | | | | |

| Mechanical | |
|----------------------------------|---|
| Dimensions | 110 x 160mm |
| Weight | 5g |
| Material (Housing) | ABS/PC |
| Material (Antenna) | PET |
| VLT (Visible Light Transmission) | 78.1% TCF (Transparent Conductive Film) |
| Connector | SMA (F) |

| Environmental | |
|-----------------------|----------------------------|
| Operation Temperature | -40°C to 85°C |
| Storage Temperature | -40°C to 85°C |
| Relative Humidity | Non-condensing 65°C 95% RH |

| 5G/4G Bands | | | |
|-------------|---|------------------|---------|
| Band Number | 5GNR / FR1 / LTE / LTE-Advanced / WCDMA / HSPA / HSPA+ / TD-SCDMA | | |
| | Uplink | Downlink | Covered |
| B1 | 1920 to 1980 | 2110 to 2170 | ✓ |
| B2 | 1850 to 1910 | 1930 to 1990 | ✓ |
| B3 | 1710 to 1785 | 1805 to 1880 | ✓ |
| B4 | 1710 to 1755 | 2110 to 2155 | ✓ |
| B5 | 824 to 849 | 869 to 894 | ✓ |
| B7 | 2500 to 2570 | 2620 to 2690 | ✓ |
| B8 | 880 to 915 | 925 to 960 | ✓ |
| B9* | 1749.9 to 1784.9 | 1844.9 to 1879.9 | ✓ |
| B11 | 1427.9 to 1447.9 | 1475.9 to 1495.9 | ✓ |
| B12 | 699 to 716 | 729 to 746 | * |
| B13 | 777 to 787 | 746 to 756 | ✓ |
| B14 | 788 to 798 | 758 to 768 | ✓ |
| B17 | 704 to 716 | 734 to 746 | * |
| B18 | 815 to 830 | 860 to 875 | ✓ |
| B19 | 830 to 845 | 875 to 890 | ✓ |
| B20 | 832 to 862 | 791 to 821 | ✓ |
| B21 | 1447.9 to 1462.9 | 1495.9 to 1510.9 | ✓ |
| B22* | 3410 to 3490 | 3510 to 3590 | ✓ |
| B23* | 2000 to 2020 | 2180 to 2200 | ✓ |
| B24 | 1626.5 to 1660.5 | 1525 to 1559 | ✓ |
| B25 | 1850 to 1915 | 1930 to 1995 | ✓ |
| B26 | 814 to 849 | 859 to 894 | ✓ |
| B27* | 807 to 824 | 852 to 869 | ✓ |
| B28 | 703 to 748 | 758 to 803 | ✓ |
| B29 | | 717 to 728 | ✓ |
| B30 | 2305 to 2315 | 2350 to 2360 | ✓ |
| B31 | 452.5 to 457.5 | 462.5 to 467.5 | * |
| B32 | | 1452 to 1496 | ✓ |
| B34 | | 2010 to 2025 | ✓ |
| B35 | | 1850 to 1910 | ✓ |
| B36 | | 1930 to 1990 | ✓ |
| B37 | | 1910 to 1930 | ✓ |
| B38 | | 2570 to 2620 | ✓ |
| B39 | | 1880 to 1920 | ✓ |
| B40 | | 2300 to 2400 | ✓ |
| B41 | | 2496 to 2690 | ✓ |
| B42 | | 3400 to 3600 | ✓ |
| B43 | | 3600 to 3800 | ✓ |
| B45 | | 1447 to 1467 | ✓ |
| B46 | | 5150 to 5925 | ✓ |
| B47 | | 5855 to 5925 | ✓ |
| B48 | | 3550 to 3700 | ✓ |
| B49 | | 3550 to 3700 | ✓ |
| B50 | | 1432 to 1517 | ✓ |
| B51 | | 1427 to 1432 | ✓ |
| B52 | | 3300 to 3400 | ✓ |
| B53 | | 2483.5 to 2495 | ✓ |
| B65 | 1920 to 2010 | 2110 to 2200 | ✓ |
| B66 | 1710 to 1780 | 2110 to 2200 | ✓ |
| B68 | 698 to 728 | 753 to 783 | ✓ |
| B69 | | 2570 to 2620 | ✓ |
| B70 | 1695 to 1710 | 1995 to 2020 | ✓ |
| B71 | 663 to 698 | 617 to 652 | ✓ |
| B72 | 451 to 456 | 461 to 466 | * |
| B73 | 450 to 455 | 460 to 465 | * |
| B74 | 1427 to 1470 | 1475 to 1518 | ✓ |
| B75 | | 1432 to 1517 | ✓ |
| B76 | | 1427 to 1432 | ✓ |
| B77 | | 3300 to 4200 | ✓ |
| B78 | | 3300 to 3800 | ✓ |
| B79 | | 4400 to 5000 | ✓ |
| B85 | 698 to 716 | 728 to 746 | ✓ |
| B87 | 410 to 415 | 420 to 425 | * |
| B88 | 412 to 417 | 422 to 427 | * |

3. Mechanical Drawing

ISO NO.: EDW.002456

STATE: RELEASE

NOTES: 1.ALL MATERIAL MUST BE ROHS COMPLIANT.

| REVISIONS | | | | |
|-----------|-------------|-----------|----------|----------|
| REV. | DESCRIPTION | DATE | ENGINEER | APPROVED |
| D01 | FIRST ISSUE | 02MAY2024 | SC | WL |

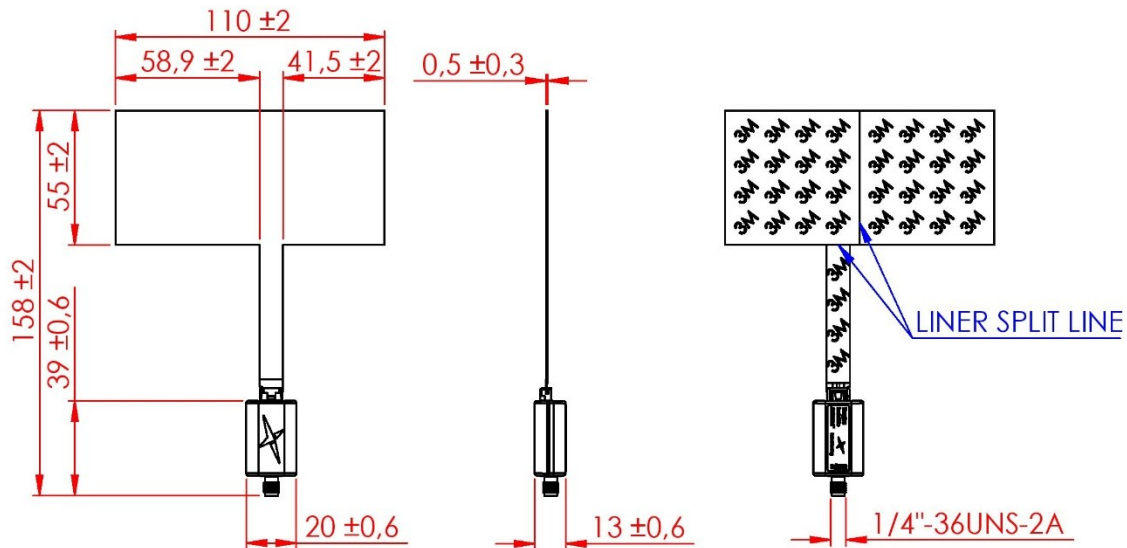

| ITEM NO. | DESCRIPTION | MATERIAL | FINISH | QTY |
|----------|---|----------|-------------|-----|
| 1 | TRANSPARENT FLEX ANTENNA COVERING 600-6000MHz | PET | CLEAR | 1 |
| 2 | FPC-to-BOARD CONNECTOR ADAPTOR 2 CONTACT | LCP | BLACK | 1 |
| 3 | ANTENNA PCB HOUSING | ABS/PC | BLACK | 1 |
| 4 | SMA (F) CONNECTOR | BRASS | GOLD | 1 |
| 5 | ADHESIVE + LINER | ADHESIVE | BROWN LINER | 1 |
| 6 | PATENT PENDING LABEL | PET | GLOSS | 1 |

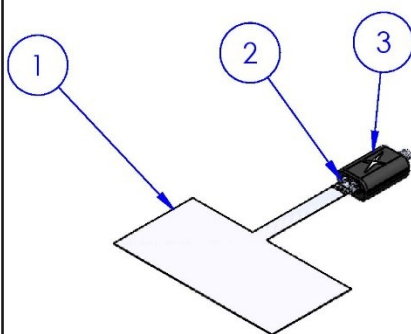

MODEL VIEW
SCALE 1:3

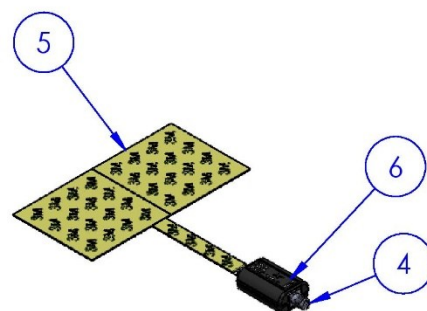

MODEL VIEW
SCALE 1:3

| | | |
|---|---|--|
| APPROVED BY: | NW | <small>EMEA Design Centre</small> This drawing and its inherent design concepts are property of Taoglas. Not to be copied or given to third parties without the written consent of Taoglas. |
| CHECK BY: | WL | |
| DRAWN BY: | SC | |
| DATE: | 02MAY2024 | |
| UNLESS OTHERWISE SPECIFIED TOLERANCES ON: | XX ± 0.3 X ± 0.3 X ± 0.2 X ± 0.1 X ± 0.05 | TITLE : |
| THIRD ANGLE PROJECTION | | Transparent Flex Antenna Covering 600-6000MHz w/connector and SMA(F) Connector |
| | | PART NO. : |
| | | TFX62.C |
| | | UNIT: mm |
| | | SCALE: 2:5 |
| | | PAGES: 1/1 |
| | | REV: D01 |

4. Packaging

1 PCS / Blister Box
 Box: 207.3 x 154.5 x 19.3mm

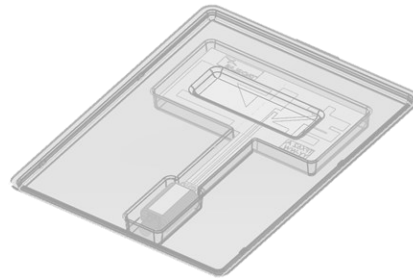

18 PCS / Column



108 PCS / Carton
 1 SET / Partition board
 Carton: 740 x 370 x 300mm
 Carton Label

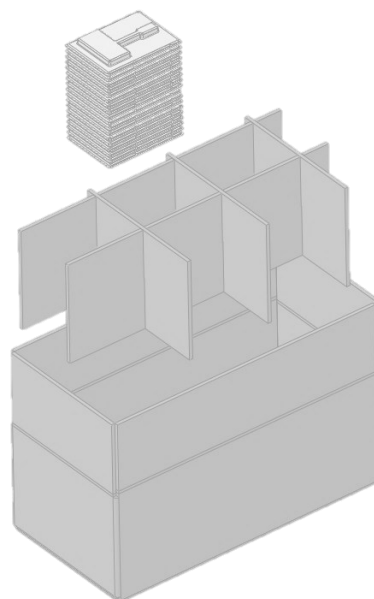

5. Antenna Characteristics

5.1 Test Setup

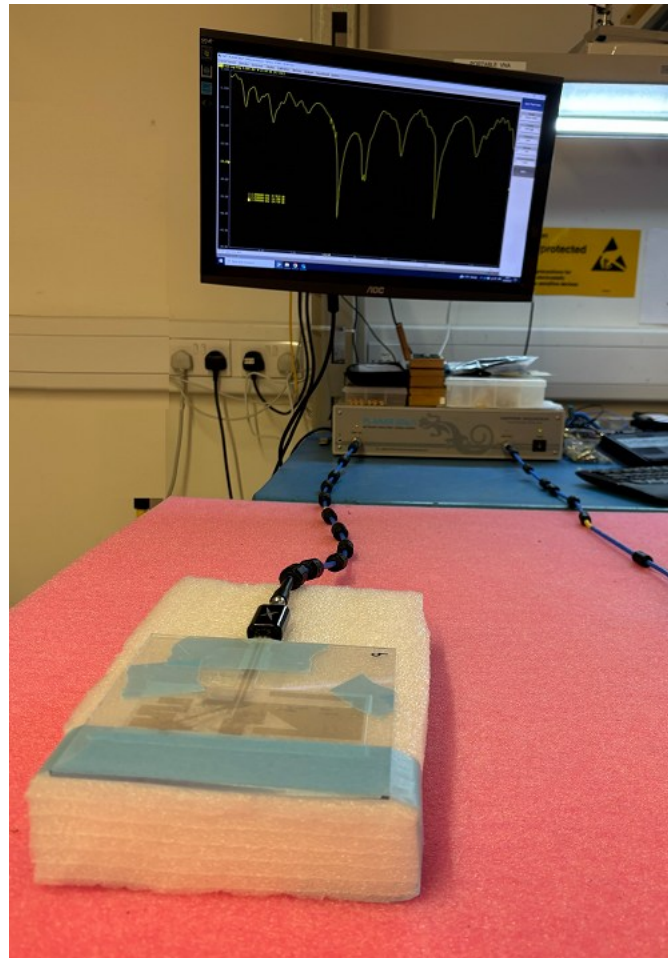
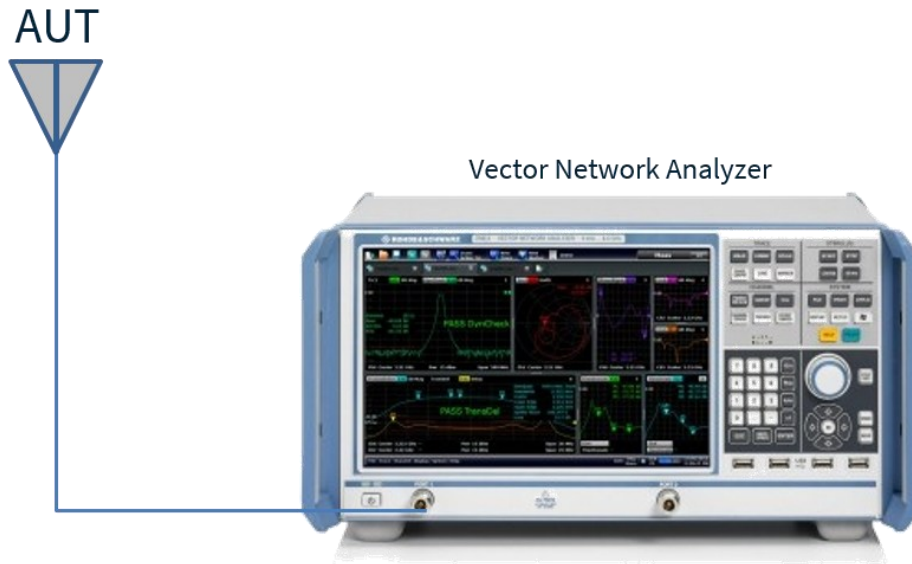

VNA Test Set-up

5.2 Return Loss

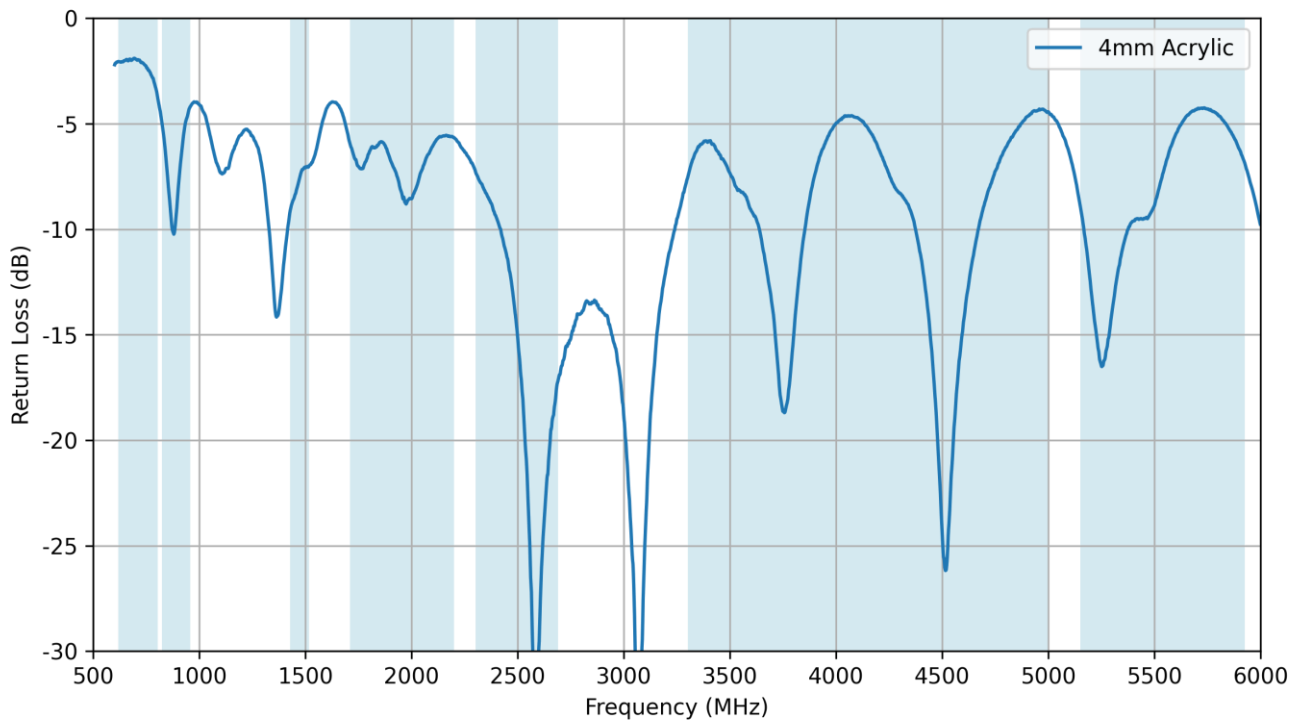

5.3 VSWR

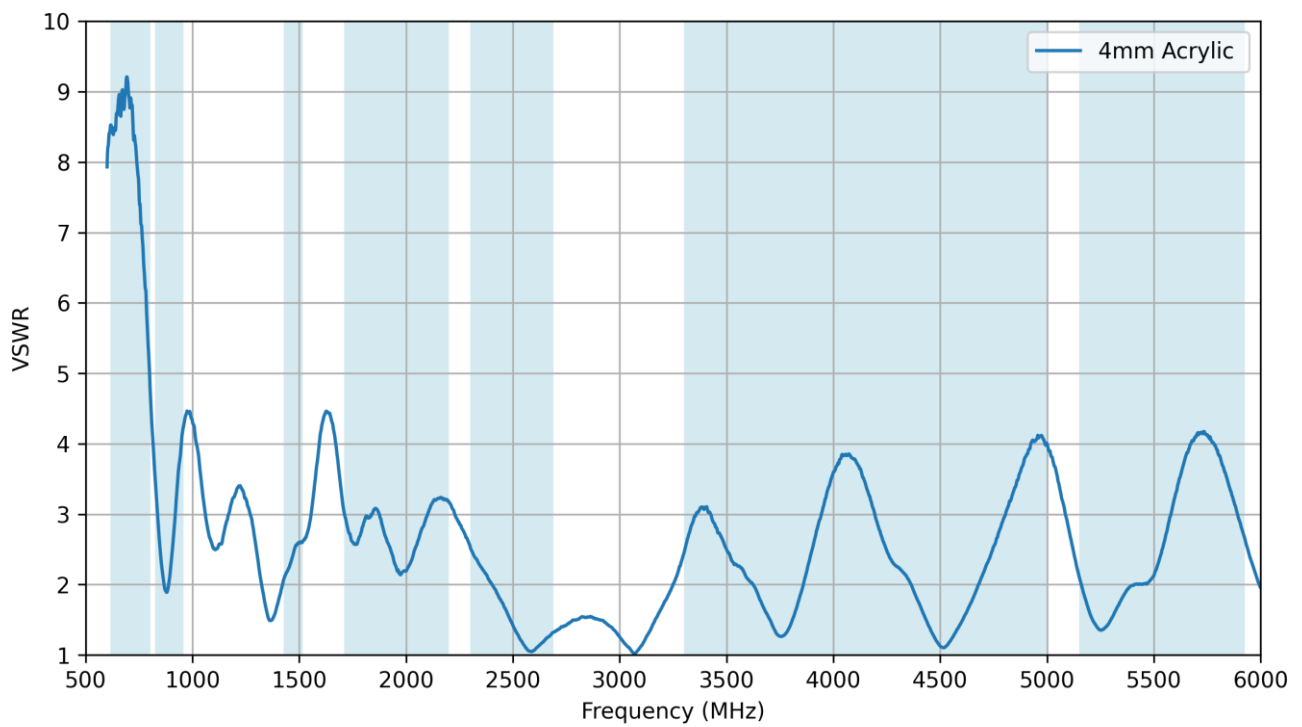

5.4 Efficiency

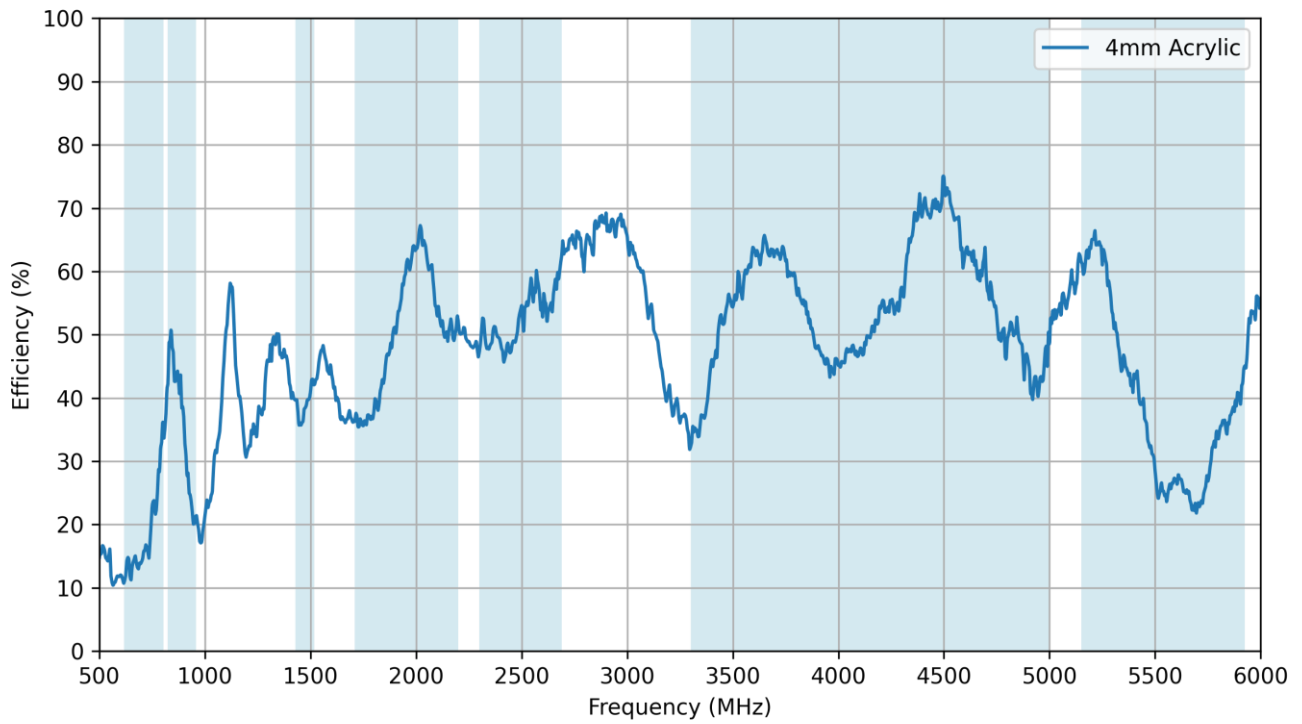

5.5 Average Gain

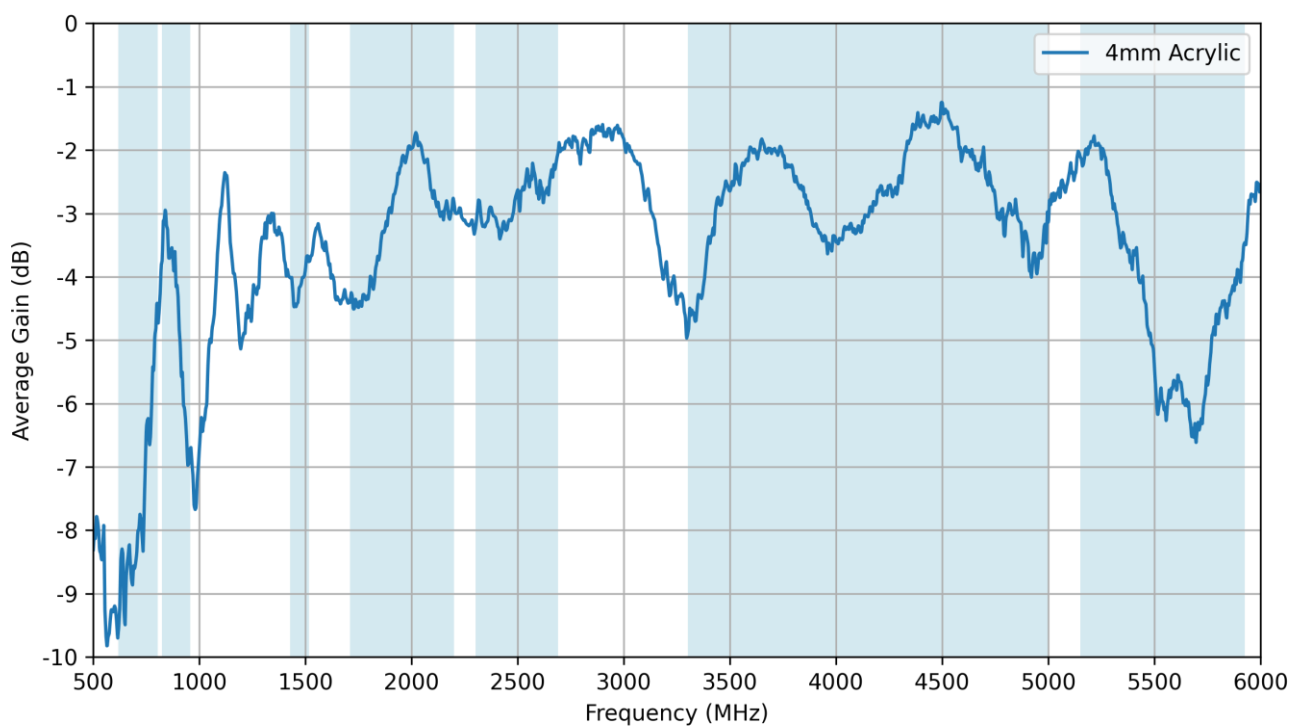

5.6 Peak Gain

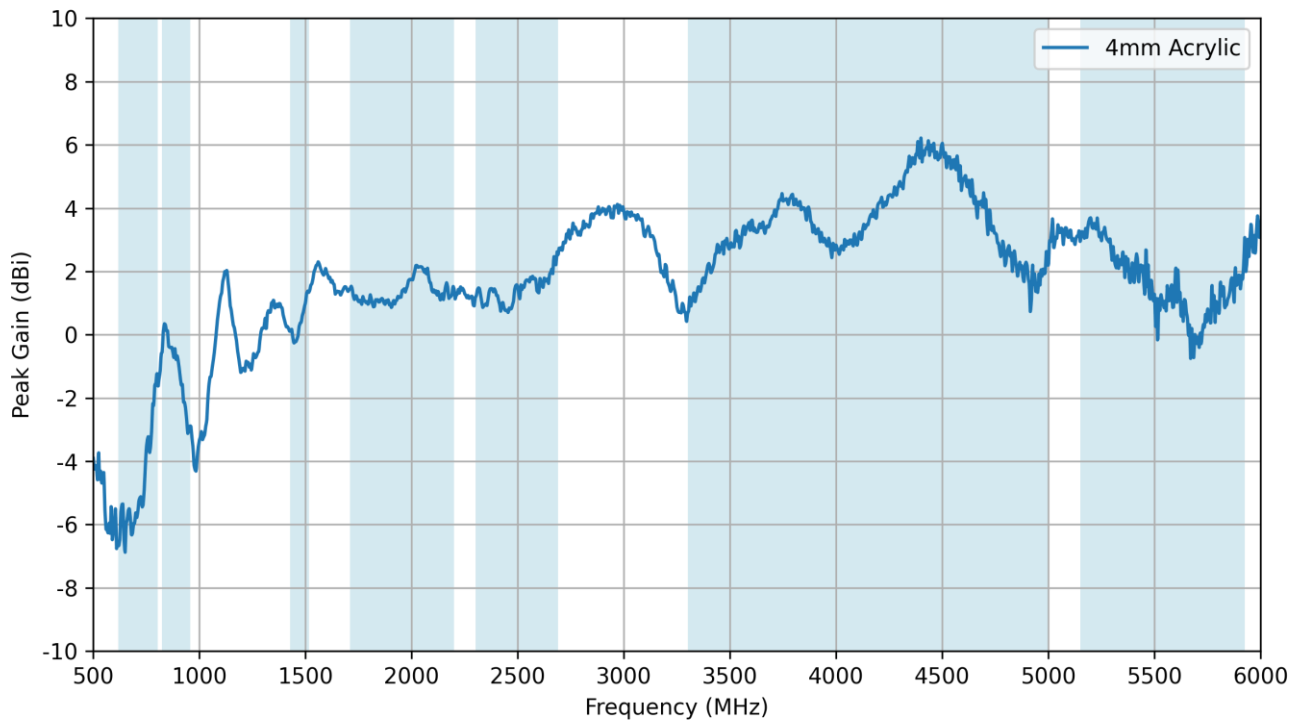

6. Radiation Patterns

6.1 Test Setup

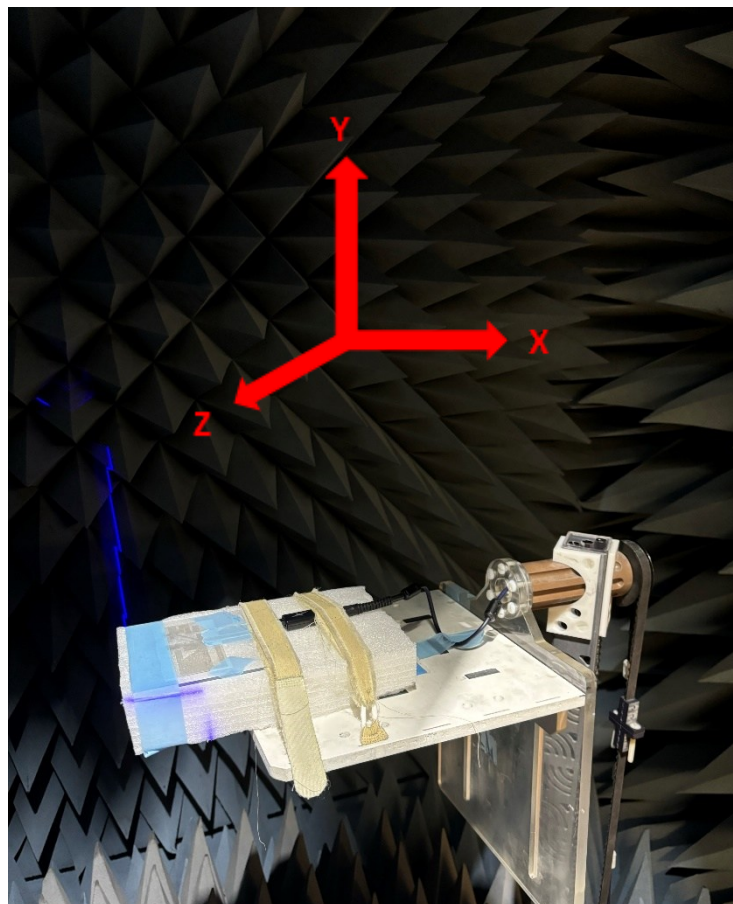
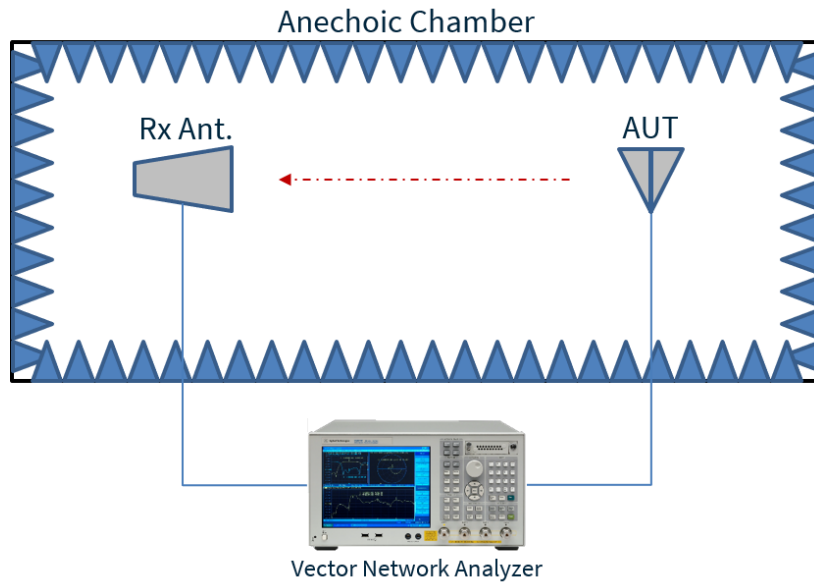

Chamber Test Set-up

6.2 4mm Acrylic Patterns at 655 MHz

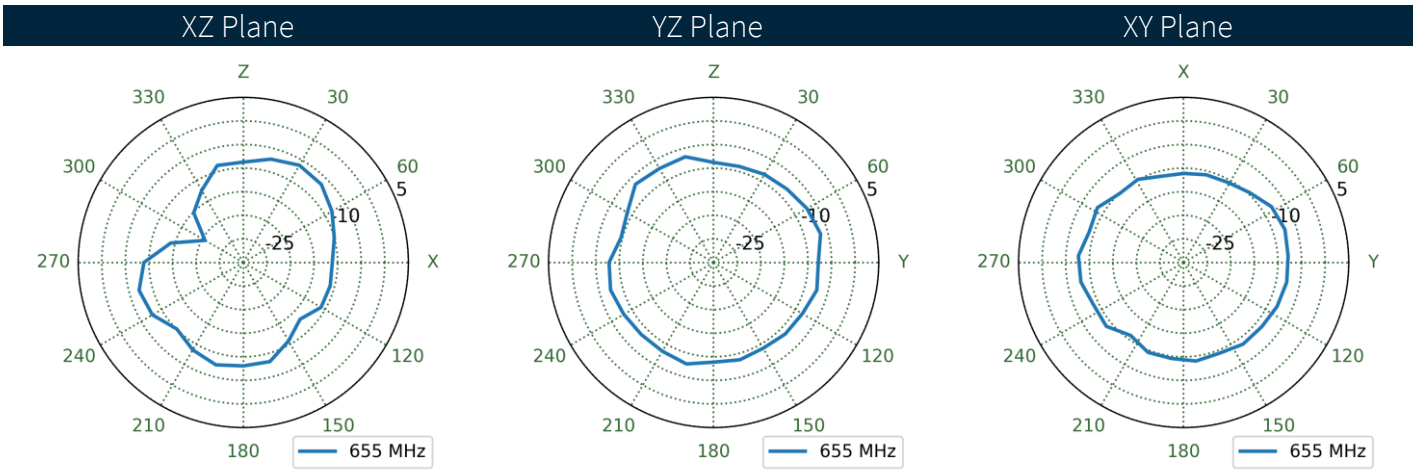
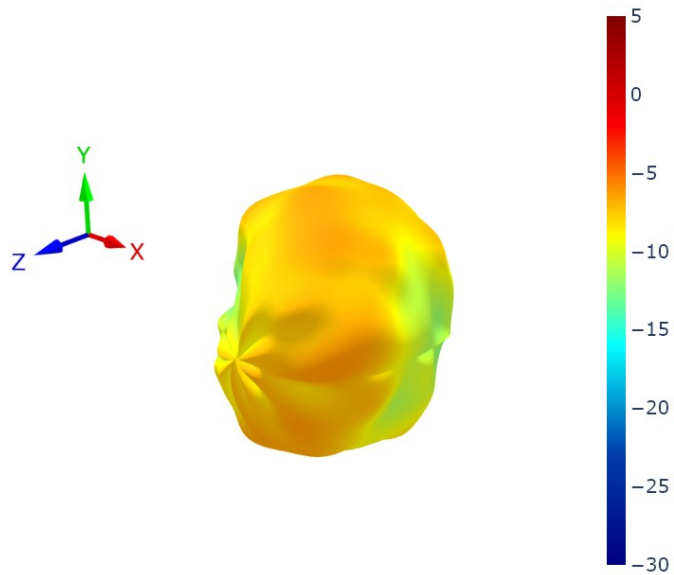

6.3 4mm Acrylic Patterns at 750 MHz

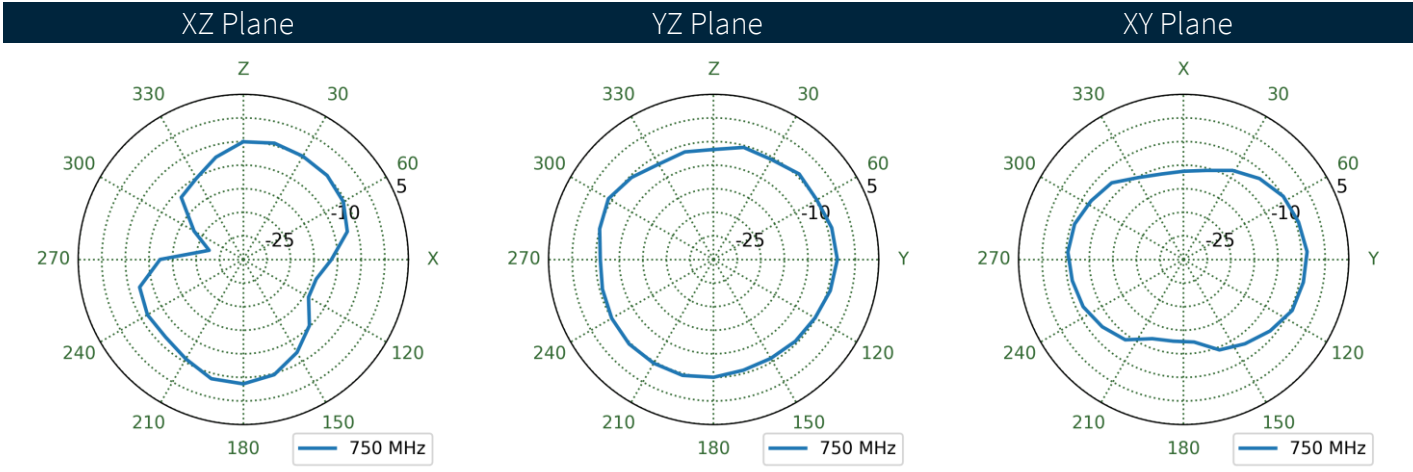
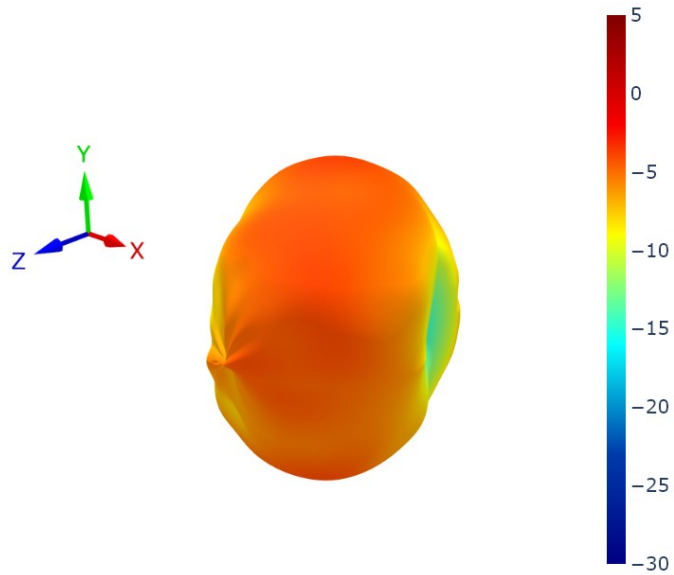

6.4 4mm Acrylic Patterns at 890 MHz

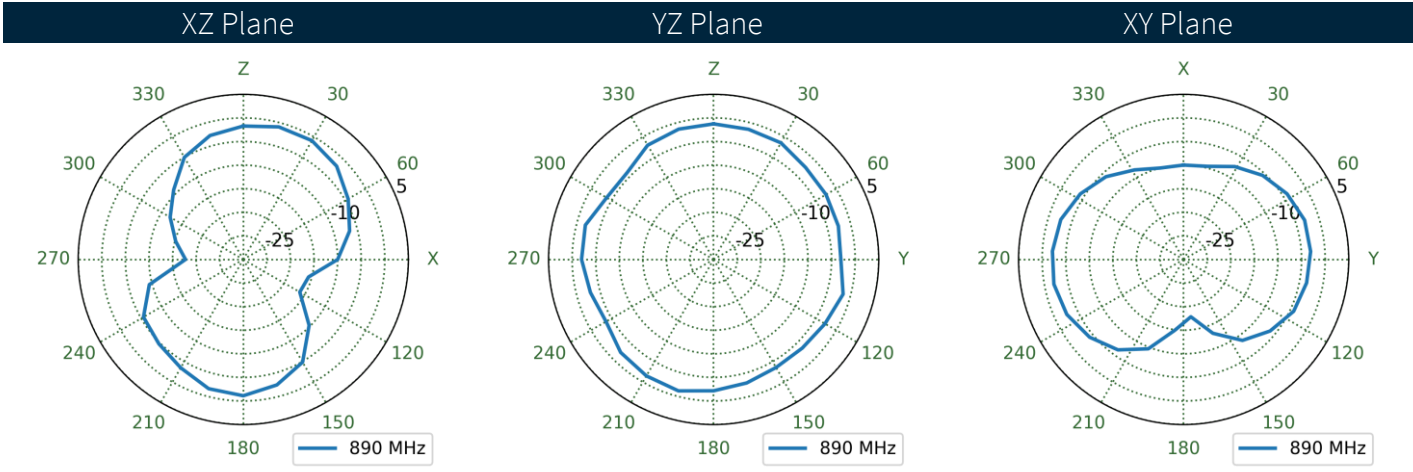
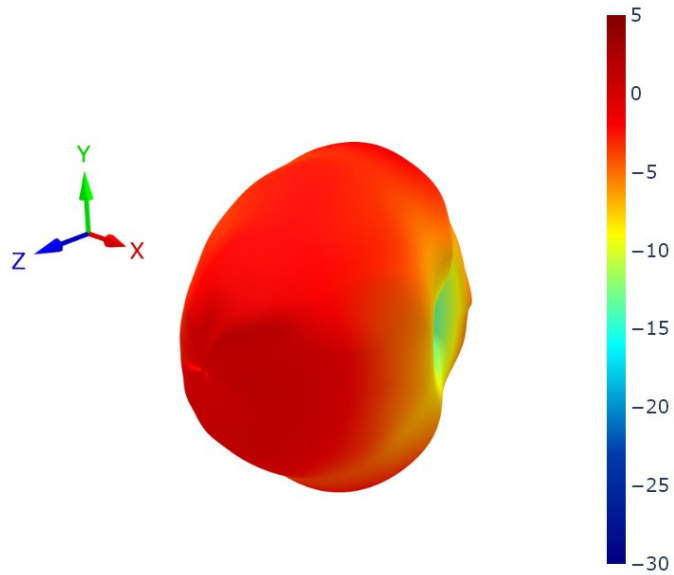

6.5 4mm Acrylic Patterns at 1470 MHz

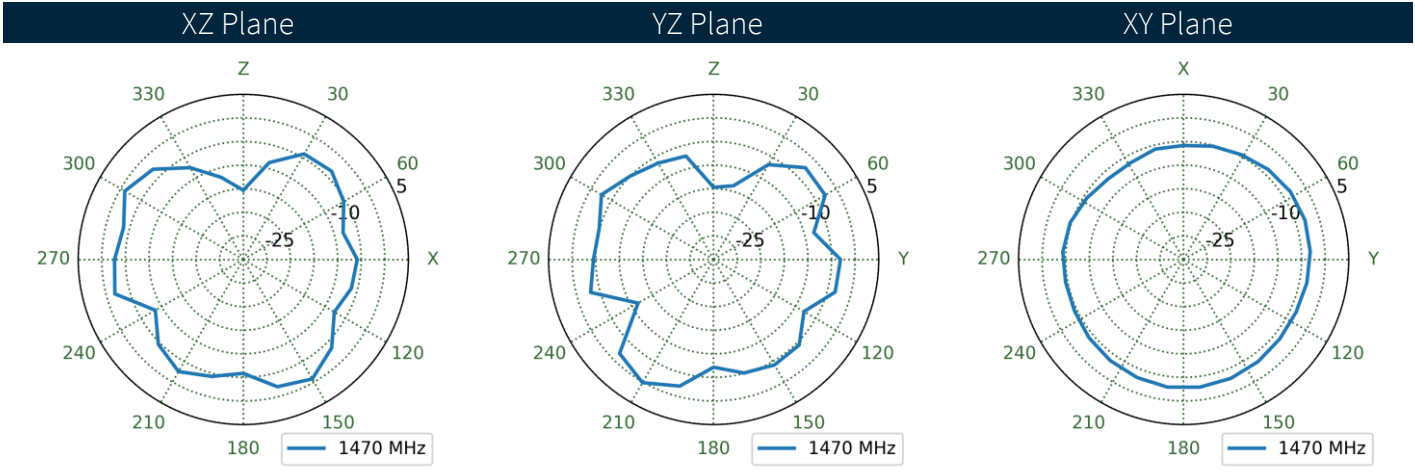
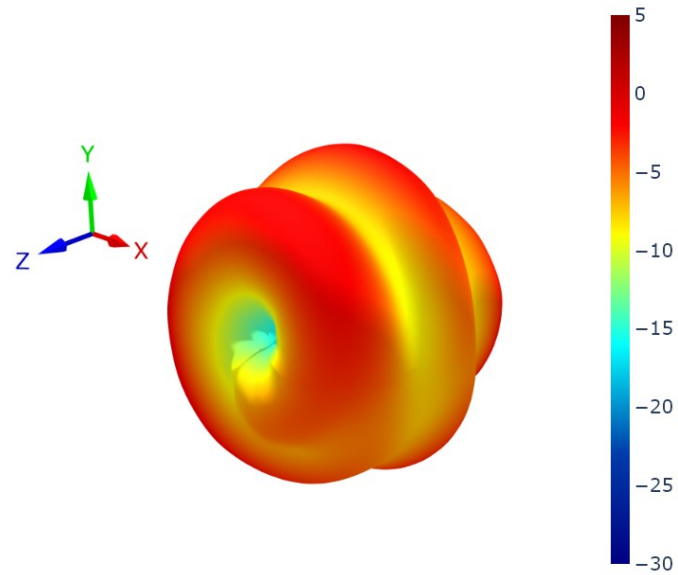

6.6 4mm Acrylic Patterns at 1955 MHz

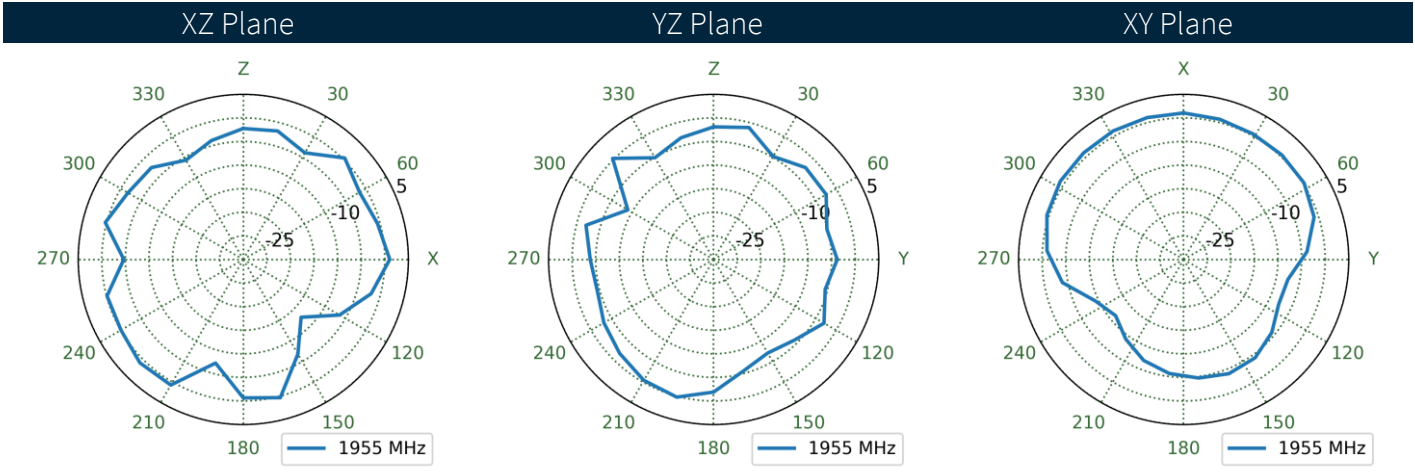
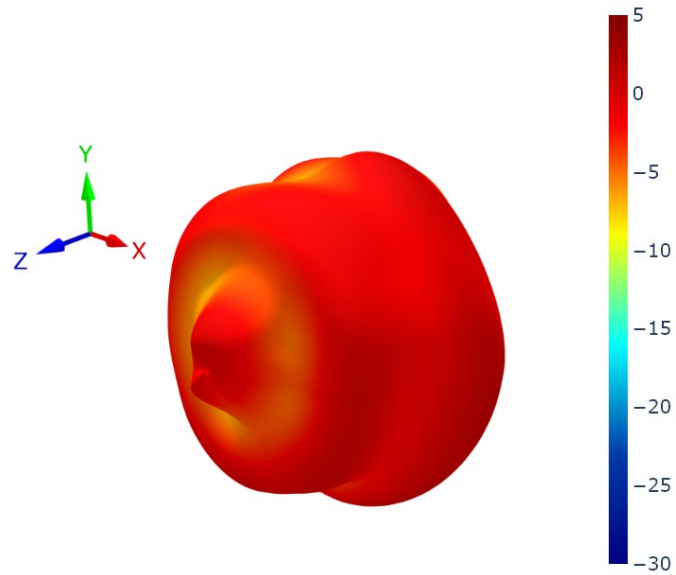

6.7 4mm Acrylic Patterns at 2495 MHz

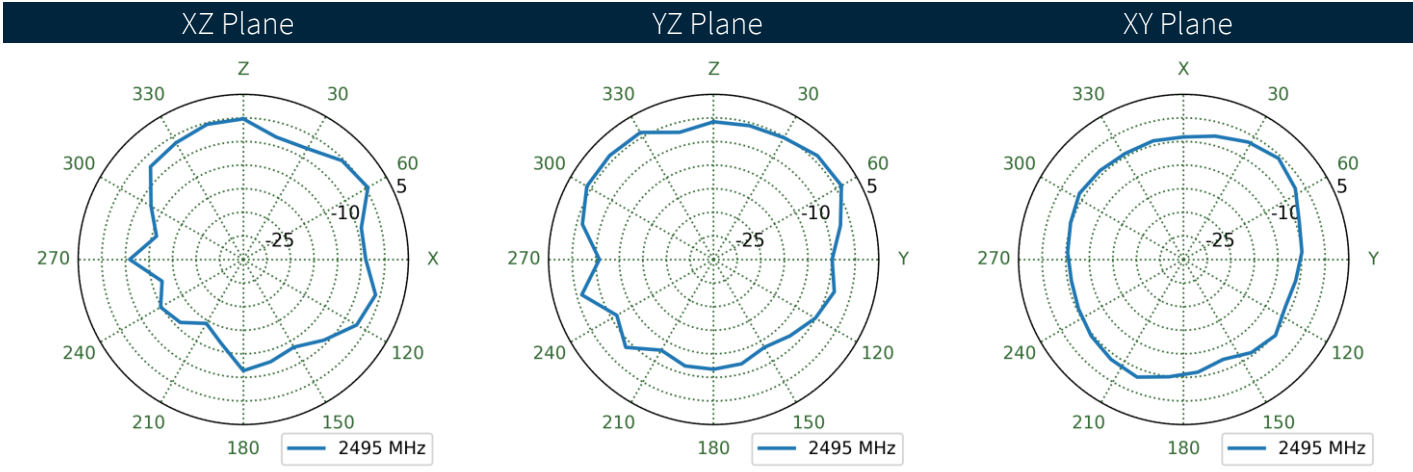
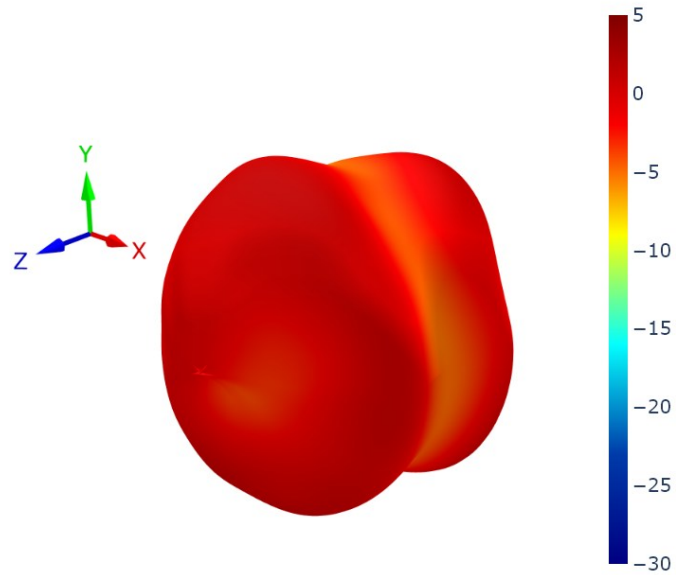

6.8 4mm Acrylic Patterns at 4150 MHz

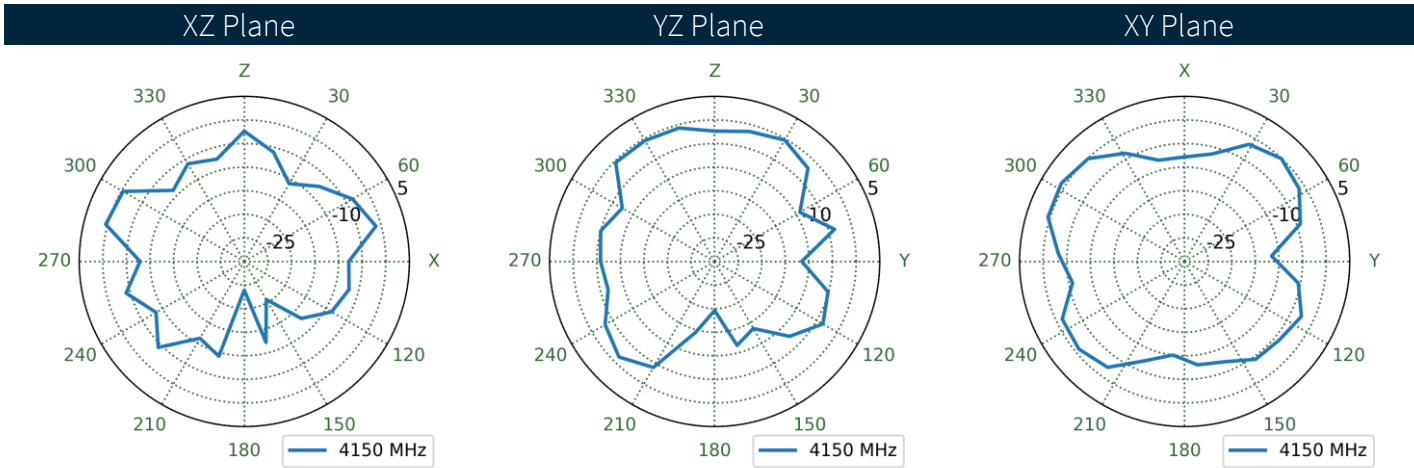
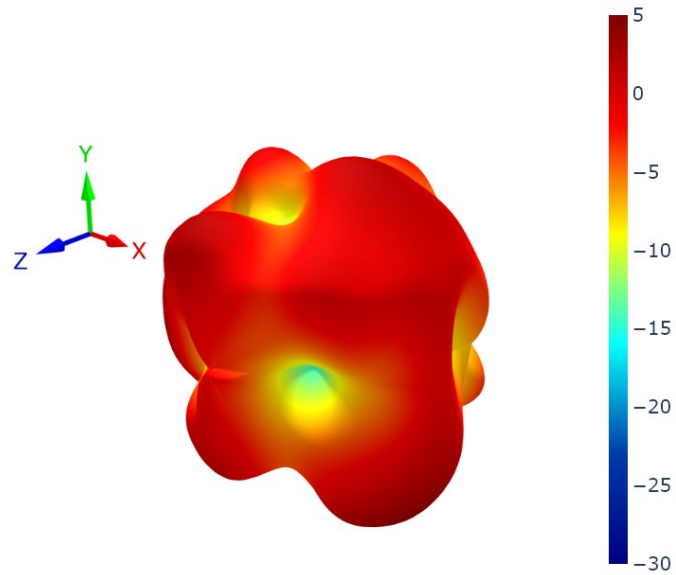

6.9 4mm Acrylic Patterns at 5535 MHz

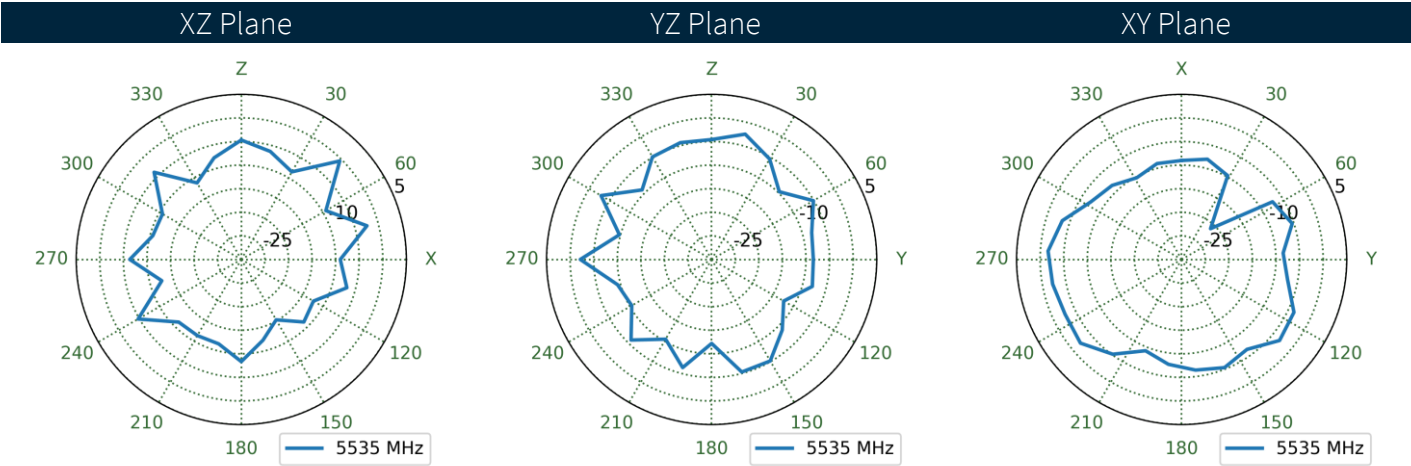
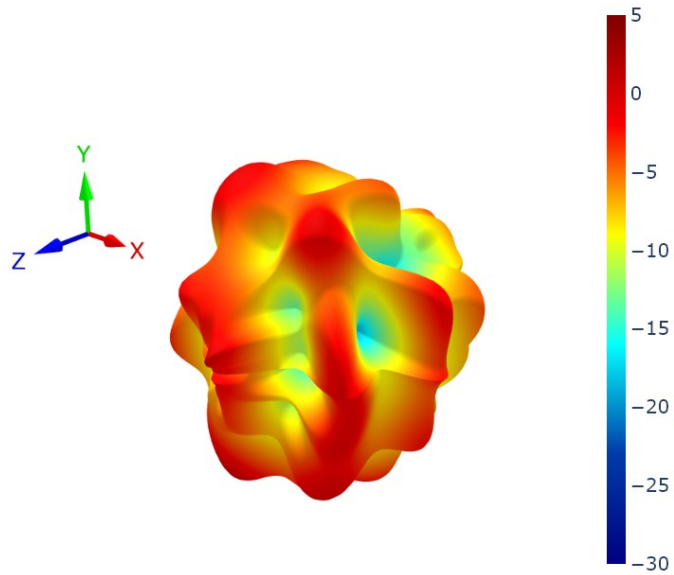

Changelog for the datasheet

SPE-24-8-215 – TFX62.C

| Revision: A (Original First Release) | |
|--------------------------------------|-----------------------|
| Date: | 2024-09-06 |
| Notes: | First initial Release |
| Author: | Gary West |

Previous Revisions

| | |
|--|--|
| | |
| | |
| | |
| | |
| | |



www.taoglas.com

