

Final datasheet

EasyPACK™ module with TRENCHSTOP™ IGBT7 and emitter controlled 7 diode and PressFIT / NTC

Features

- Electrical features
 - $V_{CES} = 1200\text{ V}$
 - $I_{C\text{ nom}} = 340\text{ A} / I_{CRM} = 680\text{ A}$
 - Ultra fast IGBT chips
 - Low inductive design
 - Low switching losses
 - Low $V_{CE,sat}$
 - Suitable Infineon gate drivers can be found under <https://www.infineon.com/gdfinder>
- Mechanical features
 - 3.2 kV AC 1 minute insulation
 - Al_2O_3 substrate with low thermal resistance
 - High current pin
 - PressFIT contact technology
 - Rugged mounting due to integrated mounting clamps

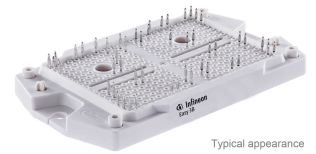

Typical appearance

Potential applications

- Three-level applications
- Solar applications

Product validation

- Qualified for industrial applications according to the relevant tests of IEC 60747, 60749 and 60068

Description

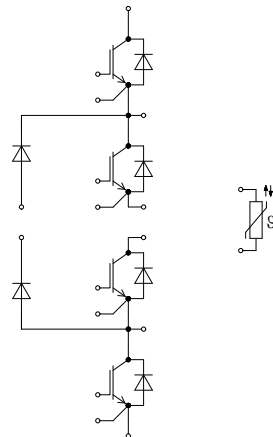

Table of contents

	Description	1
	Features	1
	Potential applications	1
	Product validation	1
	Table of contents	2
1	Package	3
2	IGBT, T1 / T4	3
3	IGBT, T2 / T3	5
4	Diode, D1 / D4	6
5	Diode, D2 / D3	7
6	Diode, D5 / D6	8
7	NTC-Thermistor	9
8	Characteristics diagrams	11
9	Circuit diagram	20
10	Package outlines	21
11	Module label code	22
	Revision history	23
	Disclaimer	24

1 Package

Table 1 Insulation coordination

Parameter	Symbol	Note or test condition	Values	Unit
Isolation test voltage	V_{ISOL}	RMS, $f = 50$ Hz, $t = 1$ min	3.2	kV
Isolation test voltage NTC	$V_{ISOL(NTC)}$	RMS, $f = 50$ Hz, $t = 1$ min	3.2	kV
Internal isolation		basic insulation (class 1, IEC 61140)	Al_2O_3	
Comparative tracking index	CTI		> 400	
Relative thermal index (electrical)	RTI		140	°C

Table 2 Characteristic values

Parameter	Symbol	Note or test condition	Values			Unit
			Min.	Typ.	Max.	
Stray inductance module	L_{SCE}			18		nH
Module lead resistance, terminals - chip	$R_{AA'+CC'}$	$T_H = 25$ °C, per switch		1.4		mΩ
Module lead resistance, terminals - chip	$R_{CC'+EE'}$	$T_H = 25$ °C, per switch		1.2		mΩ
Storage temperature	T_{stg}		-40		125	°C
Mounting torque for module mounting	M	- Mounting according to valid application note	M5, Screw	1.3	1.5	Nm
Weight	G			78		g

Note: The current under continuous operation is limited to 50 A rms per connector pin.

2 IGBT, T1 / T4

Table 3 Maximum rated values

Parameter	Symbol	Note or test condition		Values	Unit
Collector-emitter voltage	V_{CES}		$T_{vj} = 25$ °C	1200	V
Implemented collector current	I_{CN}			340	A
Continuous DC collector current	I_{CDC}	$T_{vj\ max} = 175$ °C	$T_H = 65$ °C	225	A
Repetitive peak collector current	I_{CRM}	t_p limited by $T_{vj\ op}$		680	A
Gate-emitter peak voltage	V_{GES}			±20	V

Table 4 **Characteristic values**

Parameter	Symbol	Note or test condition	Values			Unit	
			Min.	Typ.	Max.		
Collector-emitter saturation voltage	$V_{CE\ sat}$	$I_C = 340\ A, V_{GE} = 15\ V$	$T_{vj} = 25\ ^\circ C$		1.71	2.25	V
			$T_{vj} = 125\ ^\circ C$		1.91		
			$T_{vj} = 175\ ^\circ C$		2.00		
Gate threshold voltage	V_{GETh}	$I_C = 5.44\ mA, V_{CE} = V_{GE}, T_{vj} = 25\ ^\circ C$		4.85	5.5	6.15	V
Gate charge	Q_G	$V_{GE} = \pm 15\ V, V_{CC} = 600\ V, T_{vj} = 25\ ^\circ C$			5.01		μC
Internal gate resistor	R_{Gint}	$T_{vj} = 25\ ^\circ C$			2.5		Ω
Input capacitance	C_{ies}	$f = 100\ kHz, T_{vj} = 25\ ^\circ C, V_{CE} = 25\ V, V_{GE} = 0\ V$			38.6		nF
Reverse transfer capacitance	C_{res}	$f = 100\ kHz, T_{vj} = 25\ ^\circ C, V_{CE} = 25\ V, V_{GE} = 0\ V$			0.608		nF
Collector-emitter cut-off current	I_{CES}	$V_{CE} = 1200\ V, V_{GE} = 0\ V$	$T_{vj} = 25\ ^\circ C$			22	μA
Gate-emitter leakage current	I_{GES}	$V_{CE} = 0\ V, V_{GE} = 20\ V, T_{vj} = 25\ ^\circ C$				100	nA
Turn-on delay time (inductive load)	t_{don}	$I_C = 340\ A, V_{CC} = 500\ V, V_{GE} = \pm 15\ V, R_{Gon} = 0.11\ \Omega$	$T_{vj} = 25\ ^\circ C$		0.327		μs
			$T_{vj} = 125\ ^\circ C$		0.366		
			$T_{vj} = 175\ ^\circ C$		0.388		
Rise time (inductive load)	t_r	$I_C = 340\ A, V_{CC} = 500\ V, V_{GE} = \pm 15\ V, R_{Gon} = 0.11\ \Omega$	$T_{vj} = 25\ ^\circ C$		0.026		μs
			$T_{vj} = 125\ ^\circ C$		0.032		
			$T_{vj} = 175\ ^\circ C$		0.035		
Turn-off delay time (inductive load)	t_{doff}	$I_C = 340\ A, V_{CC} = 500\ V, V_{GE} = \pm 15\ V, R_{Goff} = 2.4\ \Omega$	$T_{vj} = 25\ ^\circ C$		0.510		μs
			$T_{vj} = 125\ ^\circ C$		0.570		
			$T_{vj} = 175\ ^\circ C$		0.600		
Fall time (inductive load)	t_f	$I_C = 340\ A, V_{CC} = 500\ V, V_{GE} = \pm 15\ V, R_{Goff} = 2.4\ \Omega$	$T_{vj} = 25\ ^\circ C$		0.046		μs
			$T_{vj} = 125\ ^\circ C$		0.096		
			$T_{vj} = 175\ ^\circ C$		0.121		
Turn-on energy loss per pulse	E_{on}	$I_C = 340\ A, V_{CC} = 500\ V, L_\sigma = 9\ nH, V_{GE} = \pm 15\ V, R_{Gon} = 0.11\ \Omega, di/dt = 9450\ A/\mu s (T_{vj} = 175\ ^\circ C)$	$T_{vj} = 25\ ^\circ C$		11.1		mJ
			$T_{vj} = 125\ ^\circ C$		13.5		
			$T_{vj} = 175\ ^\circ C$		15.4		
Turn-off energy loss per pulse	E_{off}	$I_C = 340\ A, V_{CC} = 500\ V, L_\sigma = 9\ nH, V_{GE} = \pm 15\ V, R_{Goff} = 2.4\ \Omega, dv/dt = 8080\ V/\mu s (T_{vj} = 175\ ^\circ C)$	$T_{vj} = 25\ ^\circ C$		7.9		mJ
			$T_{vj} = 125\ ^\circ C$		12.7		
			$T_{vj} = 175\ ^\circ C$		15.3		
Thermal resistance, junction to heat sink	R_{thJH}	per IGBT, $\lambda_{grease} = 3.3\ W/(m\cdot K)$			0.242		K/W

(table continues...)

Table 4 (continued) Characteristic values

Parameter	Symbol	Note or test condition	Values			Unit
			Min.	Typ.	Max.	
Temperature under switching conditions	$T_{vj\ op}$		-40		175	°C

Note: $T_{vj\ op} > 150\text{ °C}$ is only allowed for operation at overload conditions. For detailed specifications please refer to AN 2018-14.

3 IGBT, T2 / T3

Table 5 Maximum rated values

Parameter	Symbol	Note or test condition	Values	Unit
Collector-emitter voltage	V_{CES}	$T_{vj} = 25\text{ °C}$	1200	V
Implemented collector current	I_{CN}		340	A
Continuous DC collector current	I_{CDC}	$T_{vj\ max} = 175\text{ °C}$ $T_H = 65\text{ °C}$	235	A
Repetitive peak collector current	I_{CRM}	t_p limited by $T_{vj\ op}$	680	A
Gate-emitter peak voltage	V_{GES}		±20	V

Table 6 Characteristic values

Parameter	Symbol	Note or test condition	Values			Unit
			Min.	Typ.	Max.	
Collector-emitter saturation voltage	$V_{CE\ sat}$	$I_C = 340\text{ A}, V_{GE} = 15\text{ V}$	$T_{vj} = 25\text{ °C}$	1.71	2.25	V
			$T_{vj} = 125\text{ °C}$	1.91		
			$T_{vj} = 175\text{ °C}$	2.00		
Gate threshold voltage	V_{GETh}	$I_C = 5.44\text{ mA}, V_{CE} = V_{GE}, T_{vj} = 25\text{ °C}$	4.85	5.5	6.15	V
Gate charge	Q_G	$V_{GE} = \pm 15\text{ V}, V_{CC} = 600\text{ V}, T_{vj} = 25\text{ °C}$		5.01		μC
Internal gate resistor	R_{Gint}	$T_{vj} = 25\text{ °C}$		2.5		Ω
Input capacitance	C_{ies}	$f = 100\text{ kHz}, T_{vj} = 25\text{ °C}, V_{CE} = 25\text{ V}, V_{GE} = 0\text{ V}$		38.6		nF
Reverse transfer capacitance	C_{res}	$f = 100\text{ kHz}, T_{vj} = 25\text{ °C}, V_{CE} = 25\text{ V}, V_{GE} = 0\text{ V}$		0.608		nF
Collector-emitter cut-off current	I_{CES}	$V_{CE} = 1200\text{ V}, V_{GE} = 0\text{ V}$ $T_{vj} = 25\text{ °C}$			23	μA
Gate-emitter leakage current	I_{GES}	$V_{CE} = 0\text{ V}, V_{GE} = 20\text{ V}, T_{vj} = 25\text{ °C}$			100	nA

(table continues...)

Table 6 (continued) Characteristic values

Parameter	Symbol	Note or test condition	Values			Unit	
			Min.	Typ.	Max.		
Turn-on delay time (inductive load)	t_{don}	$I_C = 340\text{ A}, V_{CC} = 500\text{ V},$ $R_{Gon} = 0.47\ \Omega$	$T_{vj} = 25\text{ °C}$	0.370		μs	
			$T_{vj} = 125\text{ °C}$	0.410			
			$T_{vj} = 175\text{ °C}$	0.430			
Rise time (inductive load)	t_r	$I_C = 340\text{ A}, V_{CC} = 500\text{ V},$ $R_{Gon} = 0.47\ \Omega$	$T_{vj} = 25\text{ °C}$	0.036		μs	
			$T_{vj} = 125\text{ °C}$	0.041			
			$T_{vj} = 175\text{ °C}$	0.045			
Turn-off delay time (inductive load)	t_{doff}	$I_C = 340\text{ A}, V_{CC} = 500\text{ V},$ $R_{Goff} = 9.1\ \Omega$	$T_{vj} = 25\text{ °C}$	1.080		μs	
			$T_{vj} = 125\text{ °C}$	1.150			
			$T_{vj} = 175\text{ °C}$	1.200			
Fall time (inductive load)	t_f	$I_C = 340\text{ A}, V_{CC} = 500\text{ V},$ $R_{Goff} = 9.1\ \Omega$	$T_{vj} = 25\text{ °C}$	0.025		μs	
			$T_{vj} = 125\text{ °C}$	0.062			
			$T_{vj} = 175\text{ °C}$	0.096			
Turn-on energy loss per pulse	E_{on}	$I_C = 340\text{ A}, V_{CC} = 500\text{ V},$ $L_\sigma = 9\text{ nH}, R_{Gon} = 0.47\ \Omega,$ $di/dt = 7100\text{ A}/\mu\text{s}$ ($T_{vj} = 175\text{ °C}$)	$T_{vj} = 25\text{ °C}$	11.7		mJ	
			$T_{vj} = 125\text{ °C}$	12.5			
			$T_{vj} = 175\text{ °C}$	13.8			
Turn-off energy loss per pulse	E_{off}	$I_C = 340\text{ A}, V_{CC} = 500\text{ V},$ $L_\sigma = 9\text{ nH}, R_{Goff} = 9.1\ \Omega,$ $dv/dt = 5700\text{ V}/\mu\text{s}$ ($T_{vj} = 175\text{ °C}$)	$T_{vj} = 25\text{ °C}$	10.5		mJ	
			$T_{vj} = 125\text{ °C}$	14.3			
			$T_{vj} = 175\text{ °C}$	17			
Thermal resistance, junction to heat sink	R_{thJH}	per IGBT, $\lambda_{grease} = 3.3\text{ W}/(\text{m}\cdot\text{K})$			0.225		K/W
Temperature under switching conditions	T_{vjop}				-40	175	$^{\circ}\text{C}$

Note: $T_{vjop} > 150\text{ °C}$ is only allowed for operation at overload conditions. For detailed specifications please refer to AN 2018-14.

4 Diode, D1 / D4

Table 7 Maximum rated values

Parameter	Symbol	Note or test condition	Values	Unit
Repetitive peak reverse voltage	V_{RRM}	$T_{vj} = 25\text{ °C}$	1200	V
Implemented forward current	I_{FN}		400	A

(table continues...)

Table 7 (continued) Maximum rated values

Parameter	Symbol	Note or test condition	Values	Unit	
Repetitive peak forward current	I_{FRM}	$t_p = 1 \text{ ms}$	800	A	
I^2t - value	I^2t	$t_p = 10 \text{ ms}, V_R = 0 \text{ V}$	$T_{vj} = 125 \text{ °C}$	5700	A^2s
			$T_{vj} = 175 \text{ °C}$	5050	

Table 8 Characteristic values

Parameter	Symbol	Note or test condition	Values			Unit
			Min.	Typ.	Max.	
Forward voltage	V_F	$I_F = 400 \text{ A}, V_{GE} = 0 \text{ V}$	$T_{vj} = 25 \text{ °C}$	2.50	3.05	V
			$T_{vj} = 125 \text{ °C}$	2.18		
			$T_{vj} = 175 \text{ °C}$	1.98		
Peak reverse recovery current	I_{RM}	$V_{CC} = 500 \text{ V}, I_F = 400 \text{ A}, V_{GE} = -15 \text{ V}, -di_F/dt = 7100 \text{ A}/\mu\text{s} (T_{vj} = 175 \text{ °C})$	$T_{vj} = 25 \text{ °C}$	185		A
			$T_{vj} = 125 \text{ °C}$	290		
			$T_{vj} = 175 \text{ °C}$	340		
Recovered charge	Q_r	$V_{CC} = 500 \text{ V}, I_F = 400 \text{ A}, V_{GE} = -15 \text{ V}, -di_F/dt = 7100 \text{ A}/\mu\text{s} (T_{vj} = 175 \text{ °C})$	$T_{vj} = 25 \text{ °C}$	11.5		μC
			$T_{vj} = 125 \text{ °C}$	25.8		
			$T_{vj} = 175 \text{ °C}$	35.5		
Reverse recovery energy	E_{rec}	$V_{CC} = 500 \text{ V}, I_F = 400 \text{ A}, V_{GE} = -15 \text{ V}, -di_F/dt = 7100 \text{ A}/\mu\text{s} (T_{vj} = 175 \text{ °C})$	$T_{vj} = 25 \text{ °C}$	3.3		mJ
			$T_{vj} = 125 \text{ °C}$	7.89		
			$T_{vj} = 175 \text{ °C}$	11.4		
Thermal resistance, junction to heat sink	R_{thJH}	per diode, $\lambda_{grease} = 3.3 \text{ W}/(\text{m}\cdot\text{K})$	0.293			K/W
Temperature under switching conditions	T_{vjop}		-40		175	$^{\circ}\text{C}$

Note: $T_{vjop} > 150 \text{ °C}$ is allowed for operation at overload conditions. For detailed specifications, please refer to AN 2018-14.

5 Diode, D2 / D3

Table 9 Maximum rated values

Parameter	Symbol	Note or test condition	Values	Unit
Repetitive peak reverse voltage	V_{RRM}	$T_{vj} = 25 \text{ °C}$	1200	V
Implemented forward current	I_{FN}		300	A

(table continues...)

Table 9 (continued) Maximum rated values

Parameter	Symbol	Note or test condition	Values	Unit	
Continuous DC forward current	I_F		250	A	
Repetitive peak forward current	I_{FRM}	$t_P = 1 \text{ ms}$	500	A	
I^2t - value	I^2t	$t_P = 10 \text{ ms}, V_R = 0 \text{ V}$	$T_{vj} = 125 \text{ °C}$	9240	A^2s
			$T_{vj} = 175 \text{ °C}$	8070	

Table 10 Characteristic values

Parameter	Symbol	Note or test condition	Values			Unit	
			Min.	Typ.	Max.		
Forward voltage	V_F	$I_F = 250 \text{ A}, V_{GE} = 0 \text{ V}$	$T_{vj} = 25 \text{ °C}$		1.62	1.93	V
			$T_{vj} = 125 \text{ °C}$		1.50		
			$T_{vj} = 175 \text{ °C}$		1.42		
Peak reverse recovery current	I_{RM}	$V_{CC} = 500 \text{ V}, I_F = 250 \text{ A}, V_{GE} = -15 \text{ V}, -di_F/dt = 7100 \text{ A}/\mu\text{s} (T_{vj} = 175 \text{ °C})$	$T_{vj} = 25 \text{ °C}$		195		A
			$T_{vj} = 125 \text{ °C}$		265		
			$T_{vj} = 175 \text{ °C}$		307		
Recovered charge	Q_r	$V_{CC} = 500 \text{ V}, I_F = 250 \text{ A}, V_{GE} = -15 \text{ V}, -di_F/dt = 7100 \text{ A}/\mu\text{s} (T_{vj} = 175 \text{ °C})$	$T_{vj} = 25 \text{ °C}$		17.5		μC
			$T_{vj} = 125 \text{ °C}$		34.7		
			$T_{vj} = 175 \text{ °C}$		46.1		
Reverse recovery energy	E_{rec}	$V_{CC} = 500 \text{ V}, I_F = 250 \text{ A}, V_{GE} = -15 \text{ V}, -di_F/dt = 7100 \text{ A}/\mu\text{s} (T_{vj} = 175 \text{ °C})$	$T_{vj} = 25 \text{ °C}$		5.2		mJ
			$T_{vj} = 125 \text{ °C}$		11.6		
			$T_{vj} = 175 \text{ °C}$		15.7		
Thermal resistance, junction to heat sink	R_{thJH}	per diode, $\lambda_{grease} = 3.3 \text{ W}/(\text{m}\cdot\text{K})$		0.298		K/W	
Temperature under switching conditions	$T_{vj op}$		-40		175	$^{\circ}\text{C}$	

Note: $T_{vj op} > 150 \text{ °C}$ is only allowed for operation at overload conditions. For detailed specifications please refer to AN 2018-14.

6 Diode, D5 / D6

Table 11 Maximum rated values

Parameter	Symbol	Note or test condition	Values	Unit
Repetitive peak reverse voltage	V_{RRM}	$T_{vj} = 25 \text{ °C}$	1200	V

(table continues...)

Table 11 (continued) Maximum rated values

Parameter	Symbol	Note or test condition	Values	Unit	
Implemented forward current	I_{FN}		300	A	
Repetitive peak forward current	I_{FRM}	$t_P = 1 \text{ ms}$	600	A	
I^2t - value	I^2t	$t_P = 10 \text{ ms}, V_R = 0 \text{ V}$	$T_{vj} = 125 \text{ °C}$	3850	A^2s
			$T_{vj} = 175 \text{ °C}$	3300	

Table 12 Characteristic values

Parameter	Symbol	Note or test condition	Values			Unit	
			Min.	Typ.	Max.		
Forward voltage	V_F	$I_F = 300 \text{ A}, V_{GE} = 0 \text{ V}$	$T_{vj} = 25 \text{ °C}$		2.50	3.05	V
			$T_{vj} = 125 \text{ °C}$		2.18		
			$T_{vj} = 175 \text{ °C}$		1.98		
Peak reverse recovery current	I_{RM}	$V_{CC} = 500 \text{ V}, I_F = 300 \text{ A}, V_{GE} = -15 \text{ V}, -di_F/dt = 9450 \text{ A}/\mu\text{s} (T_{vj} = 175 \text{ °C})$	$T_{vj} = 25 \text{ °C}$		182		A
			$T_{vj} = 125 \text{ °C}$		276		
			$T_{vj} = 175 \text{ °C}$		329		
Recovered charge	Q_r	$V_{CC} = 500 \text{ V}, I_F = 300 \text{ A}, V_{GE} = -15 \text{ V}, -di_F/dt = 9450 \text{ A}/\mu\text{s} (T_{vj} = 175 \text{ °C})$	$T_{vj} = 25 \text{ °C}$		9		μC
			$T_{vj} = 125 \text{ °C}$		20		
			$T_{vj} = 175 \text{ °C}$		28		
Reverse recovery energy	E_{rec}	$V_{CC} = 500 \text{ V}, I_F = 300 \text{ A}, V_{GE} = -15 \text{ V}, -di_F/dt = 9450 \text{ A}/\mu\text{s} (T_{vj} = 175 \text{ °C})$	$T_{vj} = 25 \text{ °C}$		2.62		mJ
			$T_{vj} = 125 \text{ °C}$		6.41		
			$T_{vj} = 175 \text{ °C}$		9.33		
Thermal resistance, junction to heat sink	R_{thJH}	per diode, $\lambda_{grease} = 3.3 \text{ W}/(\text{m}\cdot\text{K})$		0.606		K/W	
Temperature under switching conditions	$T_{vj op}$		-40		175	$^{\circ}\text{C}$	

Note: $T_{vj op} > 150^{\circ}\text{C}$ is allowed for operation at overload conditions. For detailed specifications, please refer to AN 2018-14.

7 NTC-Thermistor

Table 13 Characteristic values

Parameter	Symbol	Note or test condition	Values			Unit
			Min.	Typ.	Max.	
Rated resistance	R_{25}	$T_{NTC} = 25 \text{ °C}$		5		$k\Omega$

(table continues...)

Table 13 (continued) **Characteristic values**

Parameter	Symbol	Note or test condition	Values			Unit
			Min.	Typ.	Max.	
Deviation of R_{100}	$\Delta R/R$	$T_{NTC} = 100\text{ °C}, R_{100} = 493\ \Omega$	-5		5	%
Power dissipation	P_{25}	$T_{NTC} = 25\text{ °C}$			20	mW
B-value	$B_{25/50}$	$R_2 = R_{25} \exp[B_{25/50}(1/T_2 - 1/(298,15\text{ K}))]$		3375		K
B-value	$B_{25/80}$	$R_2 = R_{25} \exp[B_{25/80}(1/T_2 - 1/(298,15\text{ K}))]$		3411		K
B-value	$B_{25/100}$	$R_2 = R_{25} \exp[B_{25/100}(1/T_2 - 1/(298,15\text{ K}))]$		3433		K

Note: For an analytical description of the NTC characteristics please refer to AN2009-10, chapter 4

8 Characteristics diagrams

Output characteristic (typical), IGBT, T1 / T4

$$I_C = f(V_{CE})$$

$$V_{GE} = 15 \text{ V}$$

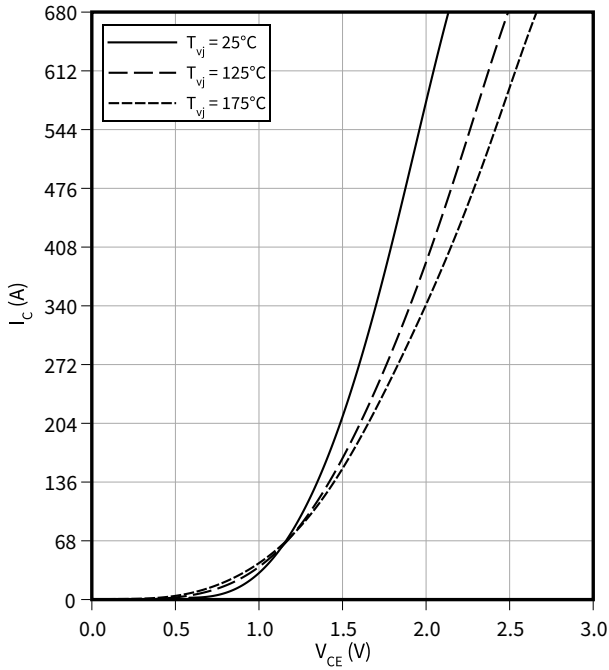

Output characteristic field (typical), IGBT, T1 / T4

$$I_C = f(V_{CE})$$

$$T_{vj} = 175 \text{ °C}$$

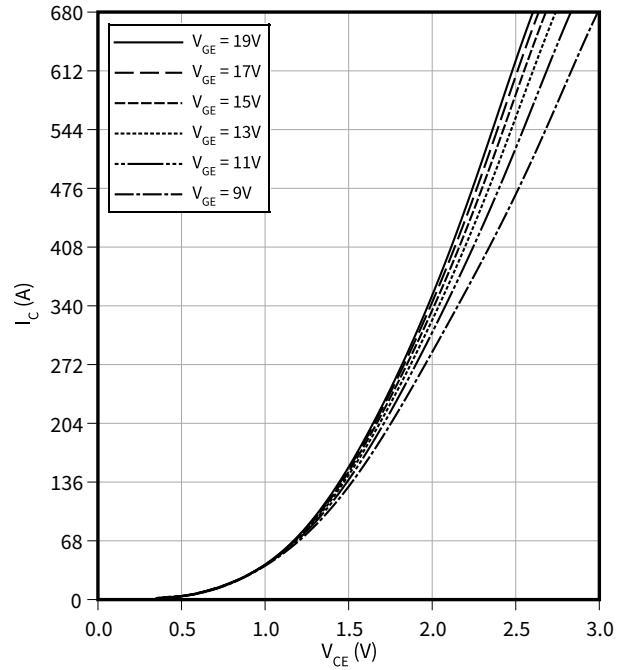

Transfer characteristic (typical), IGBT, T1 / T4

$$I_C = f(V_{GE})$$

$$V_{CE} = 20 \text{ V}$$

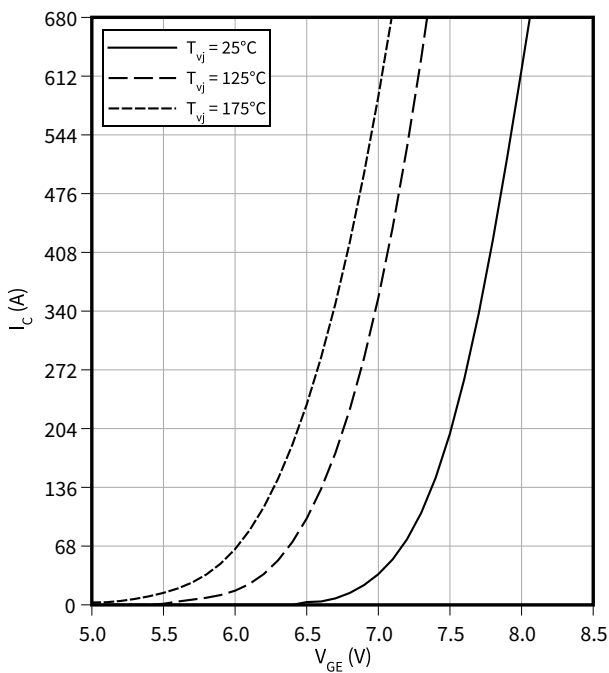

Gate charge characteristic (typical), IGBT, T1 / T4

$$V_{GE} = f(Q_G)$$

$$I_C = 340 \text{ A}, T_{vj} = 25 \text{ °C}$$

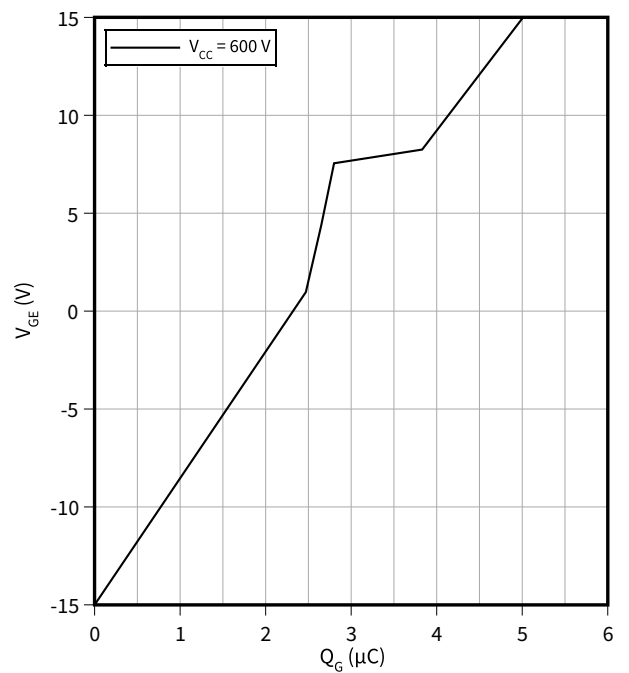

Capacity characteristic (typical), IGBT, T1 / T4

$C = f(V_{CE})$
 $f = 100 \text{ kHz}, V_{GE} = 0 \text{ V}, T_{vj} = 25 \text{ }^\circ\text{C}$

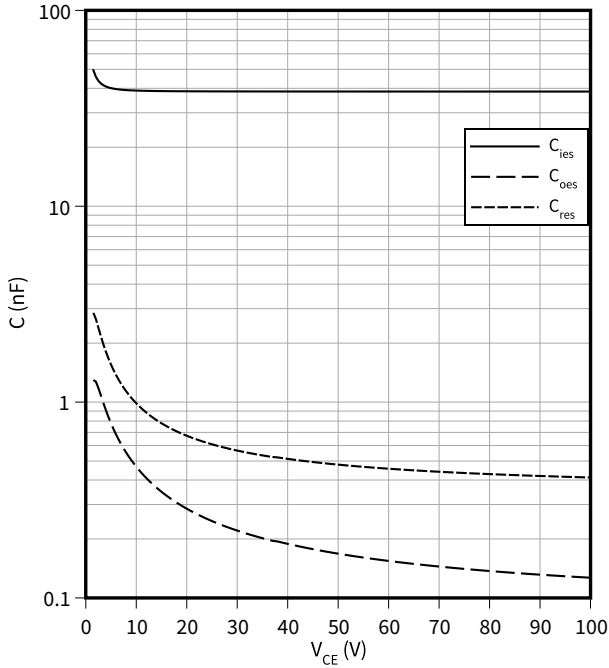

Switching times (typical), IGBT, T1 / T4

$t = f(I_C)$
 $R_{Goff} = 2.4 \text{ } \Omega, R_{Gon} = 0.11 \text{ } \Omega, V_{GE} = \pm 15 \text{ V}, V_{CC} = 500 \text{ V}, T_{vj} = 175 \text{ }^\circ\text{C}$

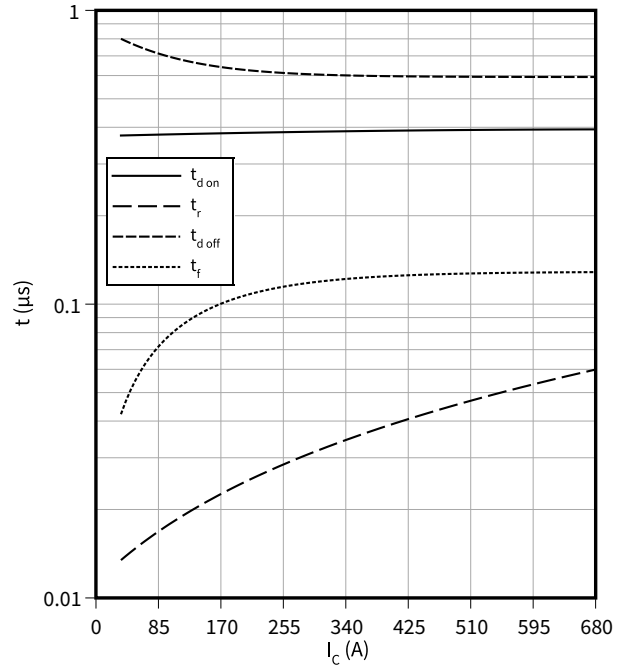

Switching times (typical), IGBT, T1 / T4

$t = f(R_G)$
 $V_{GE} = \pm 15 \text{ V}, I_C = 340 \text{ A}, V_{CC} = 500 \text{ V}, T_{vj} = 175 \text{ }^\circ\text{C}$

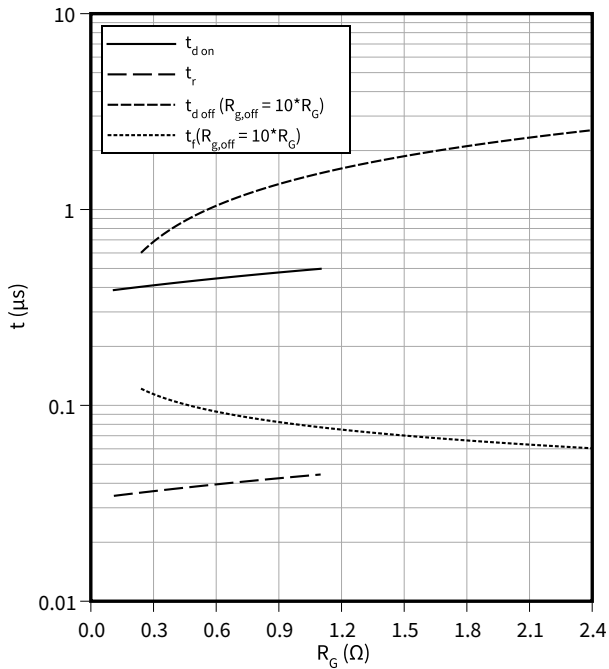

Switching losses (typical), IGBT, T1 / T4

$E = f(I_C)$
 $R_{Goff} = 2.4 \text{ } \Omega, R_{Gon} = 0.11 \text{ } \Omega, V_{CC} = 500 \text{ V}, \pm 15 \text{ V}$

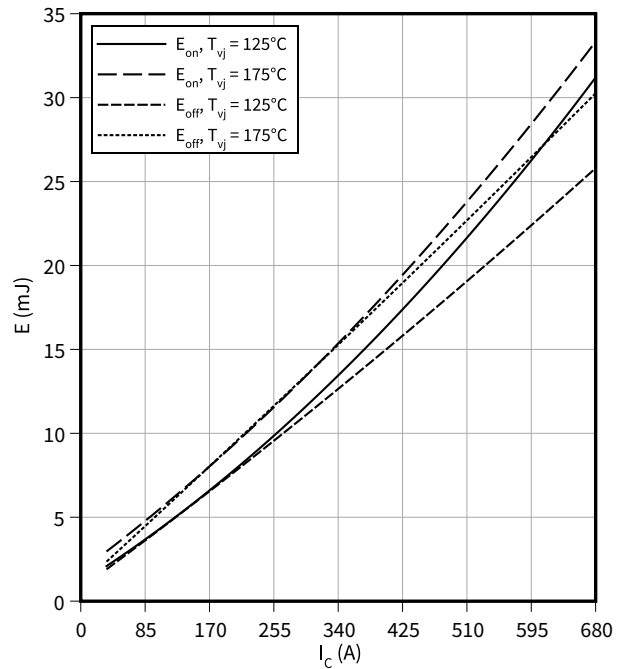

Switching losses (typical), IGBT, T1 / T4

$E = f(R_G)$

$I_C = 340 \text{ A}, V_{CC} = 500 \text{ V}, \pm 15 \text{ V}$

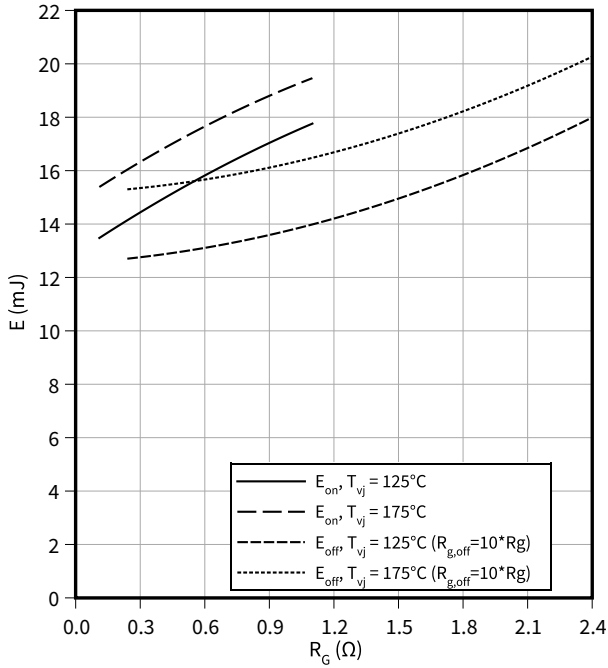

Reverse bias safe operating area (RBSOA), IGBT, T1 / T4

$I_C = f(V_{CE})$

$R_{Goff} = 2.4 \Omega, V_{GE} = \pm 15 \text{ V}, T_{vj} = 175 \text{ °C}$

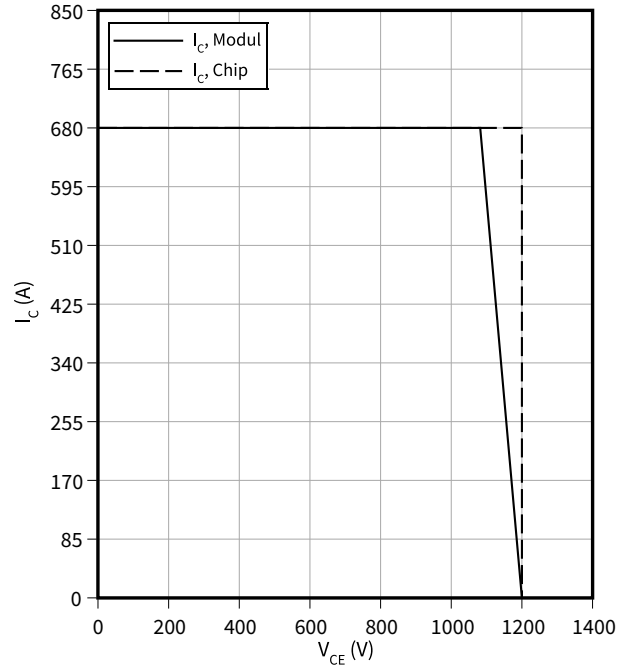

Transient thermal impedance, IGBT, T1 / T4

$Z_{th} = f(t)$

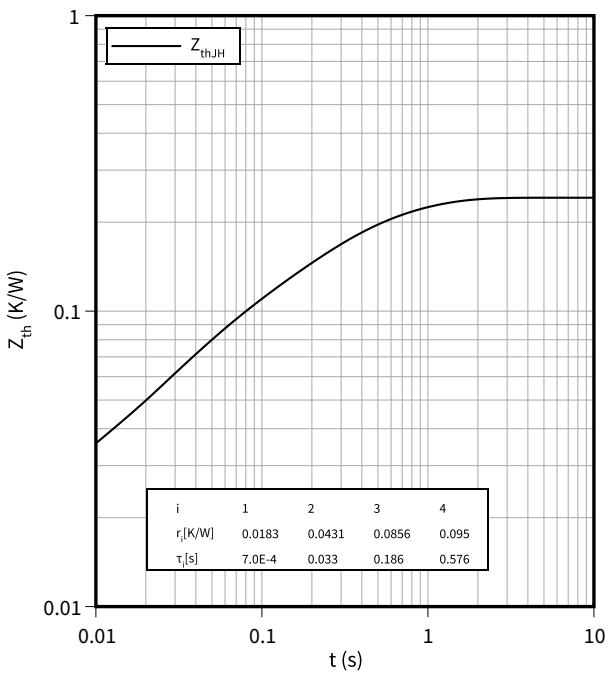

Output characteristic (typical), IGBT, T2 / T3

$I_C = f(V_{CE})$

$V_{GE} = 15 \text{ V}$

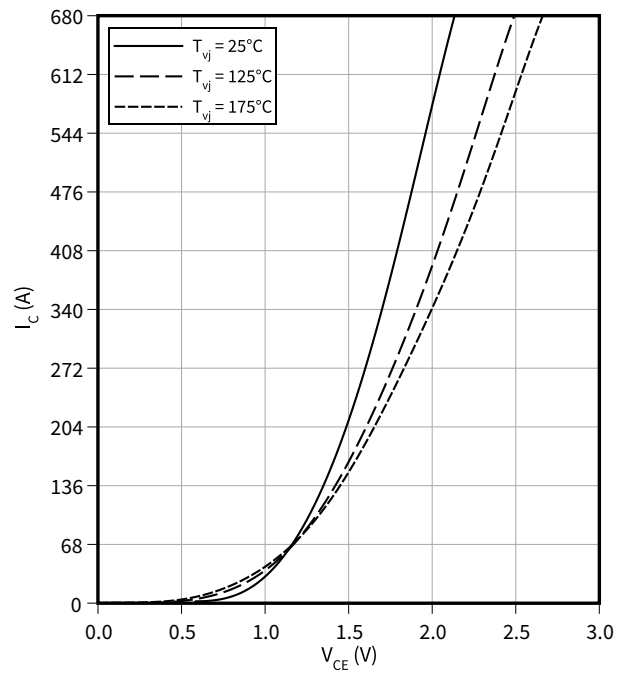

Output characteristic field (typical), IGBT, T2 / T3

$I_C = f(V_{CE})$
 $T_{vj} = 175\text{ °C}$

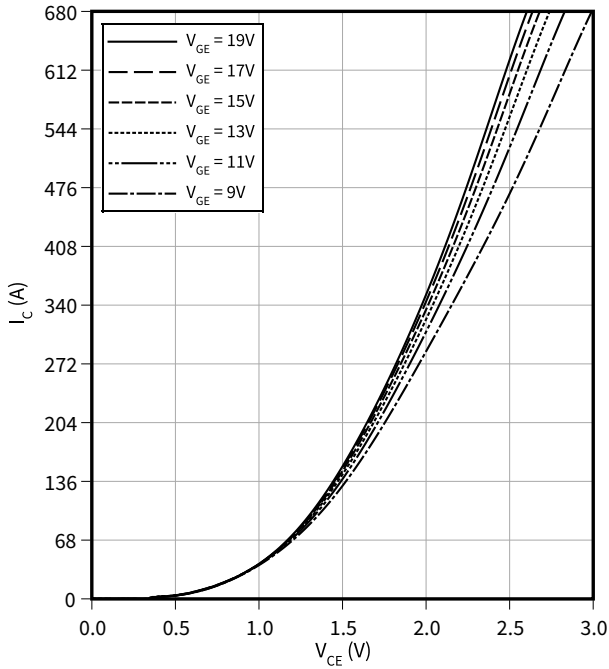

Transfer characteristic (typical), IGBT, T2 / T3

$I_C = f(V_{GE})$
 $V_{CE} = 20\text{ V}$

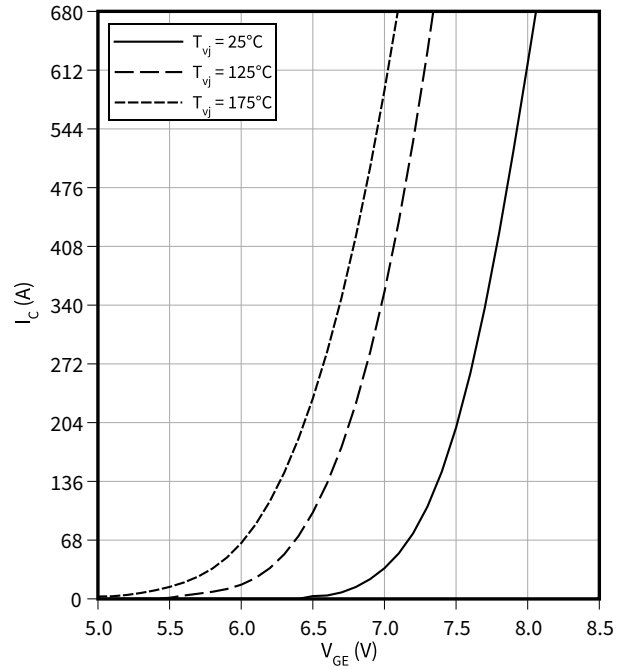

Gate charge characteristic (typical), IGBT, T2 / T3

$V_{GE} = f(Q_G)$
 $I_C = 340\text{ A}, T_{vj} = 25\text{ °C}$

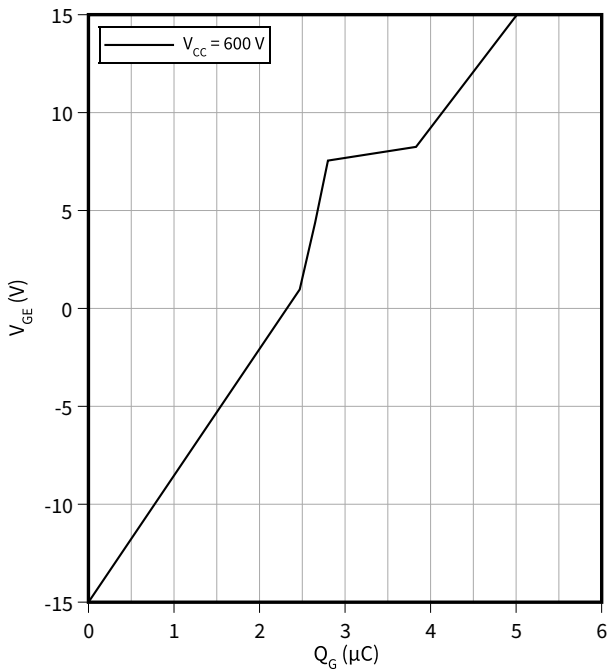

Capacity characteristic (typical), IGBT, T2 / T3

$C = f(V_{CE})$
 $f = 100\text{ kHz}, V_{GE} = 0\text{ V}, T_{vj} = 25\text{ °C}$

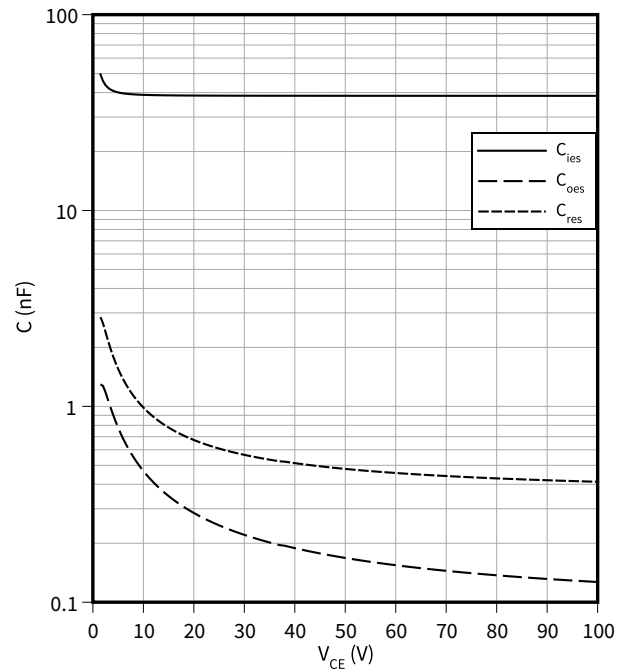

Switching times (typical), IGBT, T2 / T3

$t = f(I_C)$

$R_{Goff} = 9.1 \Omega$, $R_{Gon} = 0.47 \Omega$, $V_{GE} = \pm 15 V$, $V_{CC} = 500 V$, $T_{vj} = 175^\circ C$

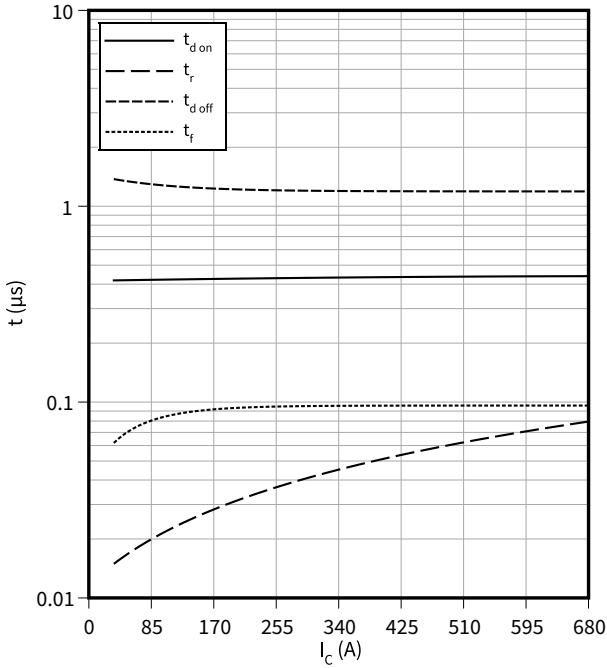

Switching times (typical), IGBT, T2 / T3

$t = f(R_G)$

$V_{GE} = \pm 15 V$, $I_C = 340 A$, $V_{CC} = 500 V$, $T_{vj} = 175^\circ C$

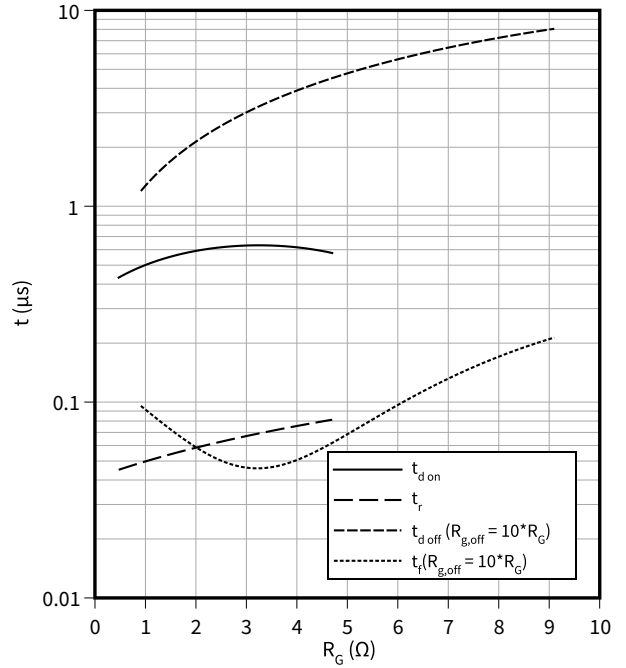

Switching losses (typical), IGBT, T2 / T3

$E = f(I_C)$

$R_{Goff} = 9.1 \Omega$, $R_{Gon} = 0.47 \Omega$, $V_{CC} = 500 V$, $\pm 15 V$

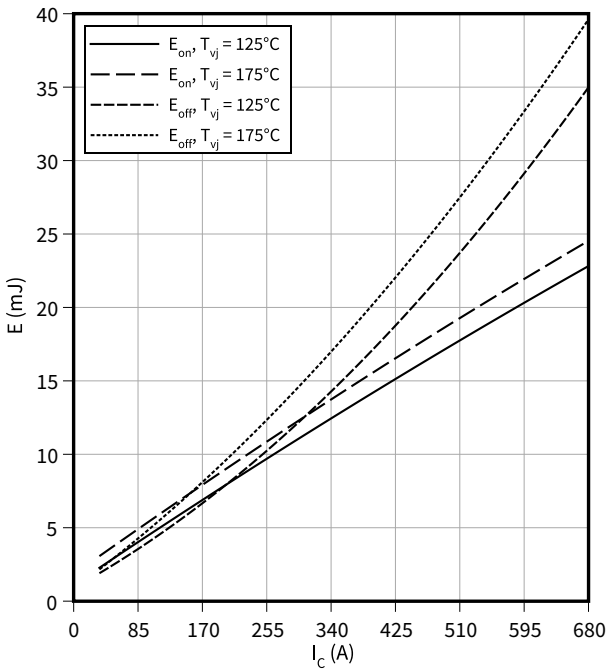

Switching losses (typical), IGBT, T2 / T3

$E = f(R_G)$

$I_C = 340 A$, $V_{CC} = 500 V$, $\pm 15 V$

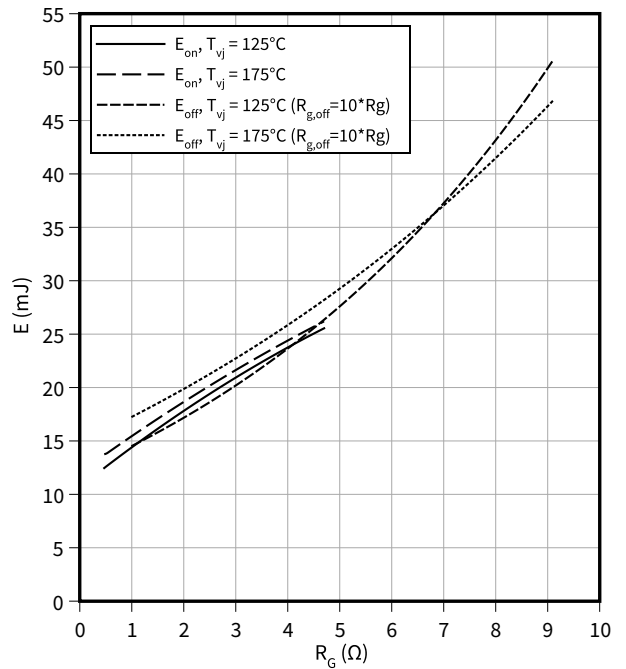

Reverse bias safe operating area (RBSOA), IGBT, T2 / T3

$I_C = f(V_{CE})$

$R_{Goff} = 9.1 \Omega$, $V_{GE} = \pm 15 V$, $T_{vj} = 175 \text{ }^\circ\text{C}$

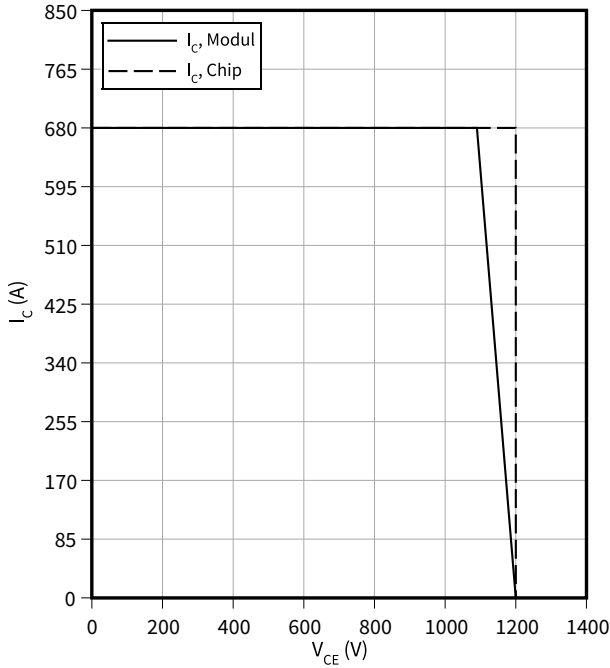

Transient thermal impedance, IGBT, T2 / T3

$Z_{th} = f(t)$

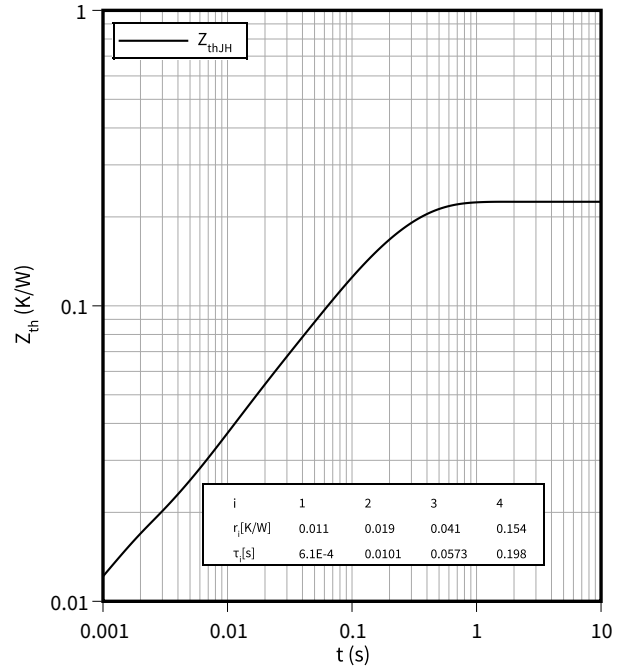

Forward characteristic (typical), Diode, D1 / D4

$I_F = f(V_F)$

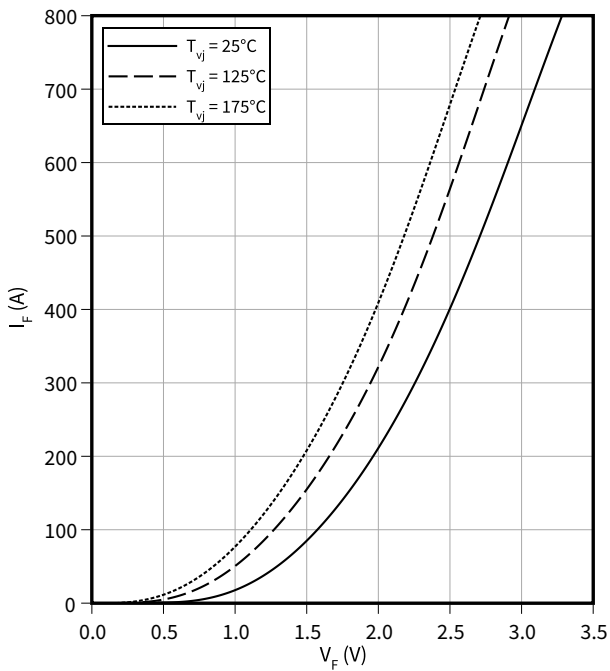

Switching losses (typical), Diode, D1 / D4

$E_{rec} = f(I_F)$

$R_{Gon} = 0.47 \Omega$, $V_{CC} = 500 V$

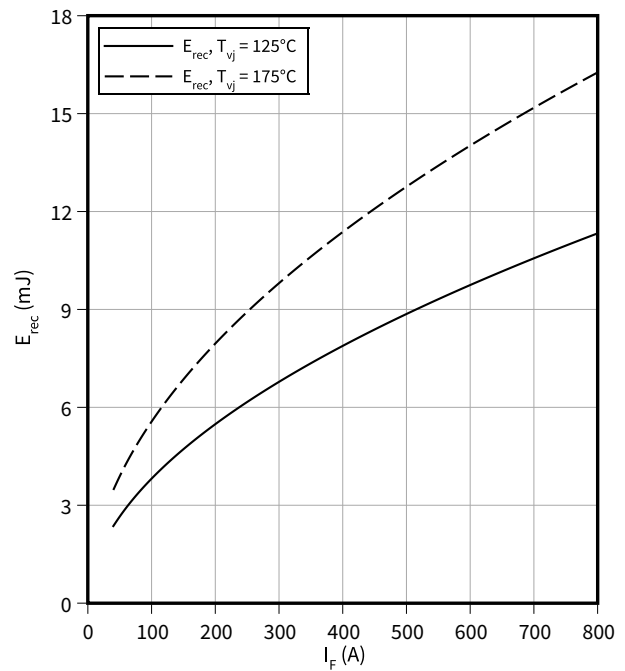

Switching losses (typical), Diode, D1 / D4

$E_{rec} = f(R_G)$

$I_F = 400 \text{ A}, V_{CC} = 500 \text{ V}$

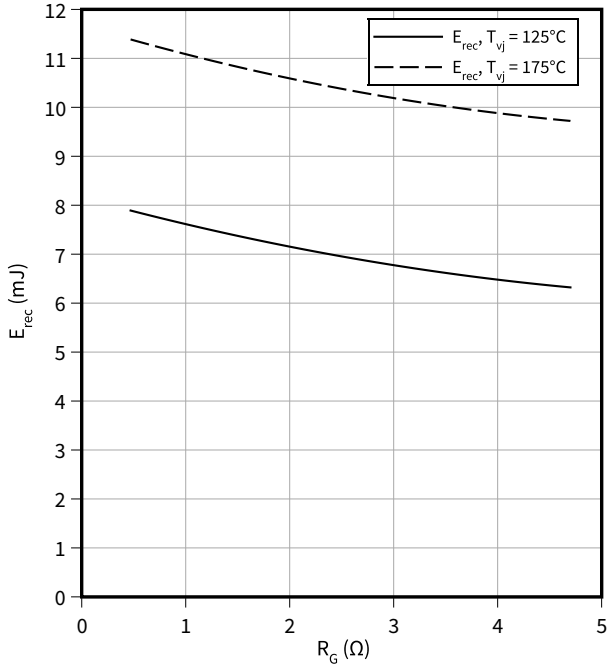

Transient thermal impedance, Diode, D1 / D4

$Z_{th} = f(t)$

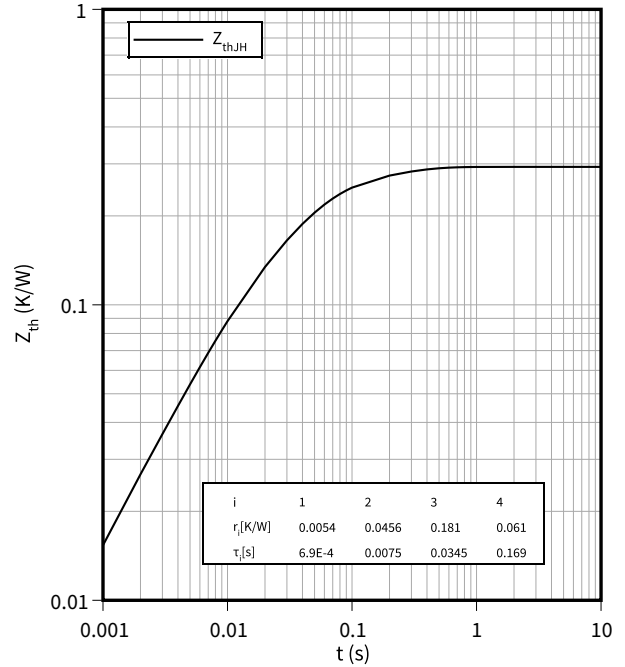

Forward characteristic (typical), Diode, D2 / D3

$I_F = f(V_F)$

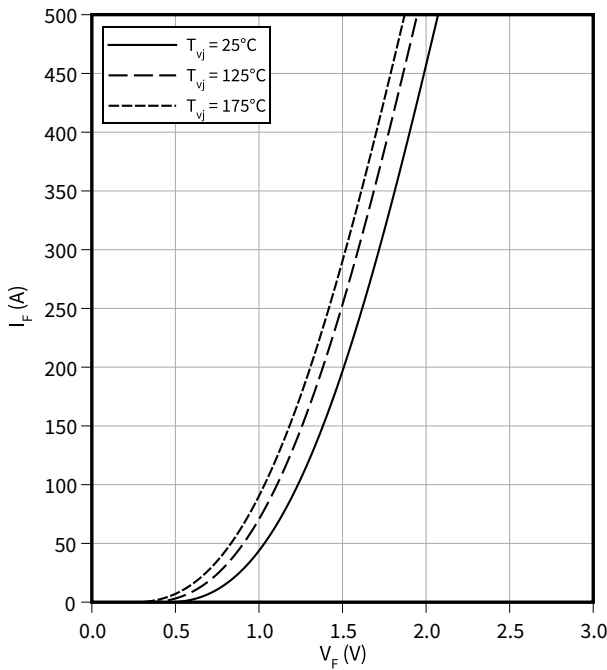

Switching losses (typical), Diode, D2 / D3

$E_{rec} = f(I_F)$

$R_{Gon} = 0.47 \Omega, V_{CC} = 500 \text{ V}$

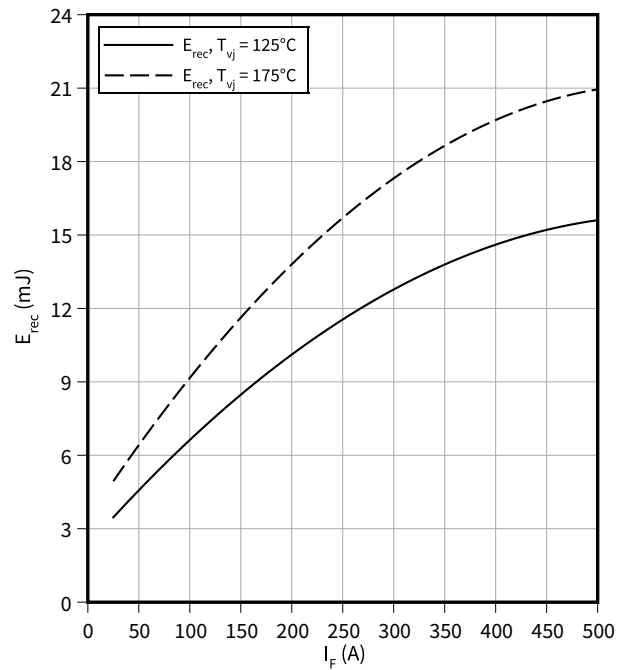

Switching losses (typical), Diode, D2 / D3

$E_{rec} = f(R_G)$

$I_F = 250 \text{ A}, V_{CC} = 500 \text{ V}$

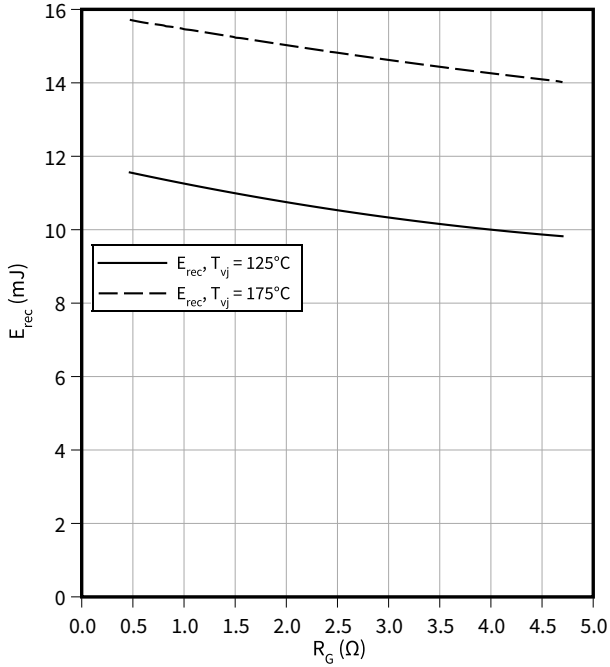

Transient thermal impedance, Diode, D2 / D3

$Z_{th} = f(t)$

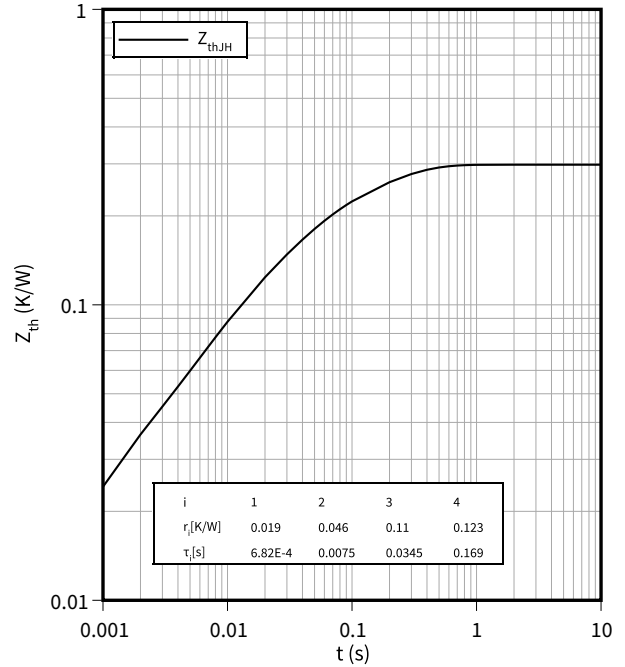

Forward characteristic (typical), Diode, D5 / D6

$I_F = f(V_F)$

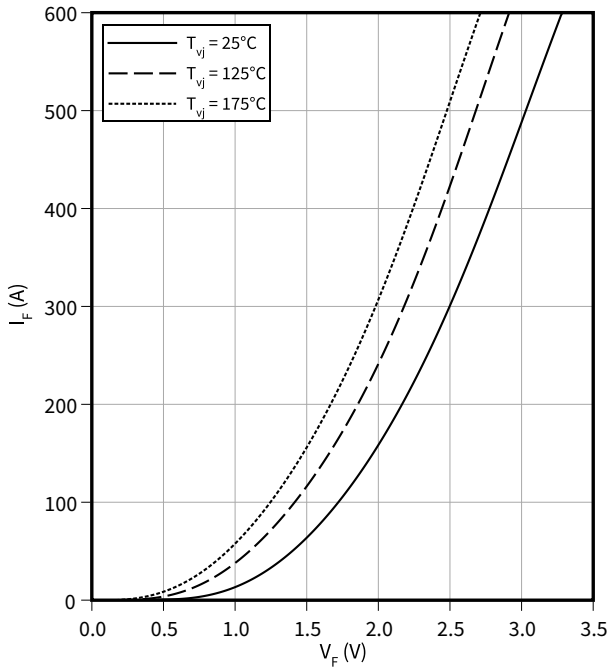

Switching losses (typical), Diode, D5 / D6

$E_{rec} = f(I_F)$

$R_{Gon} = 0.11 \Omega, V_{CC} = 500 \text{ V}$

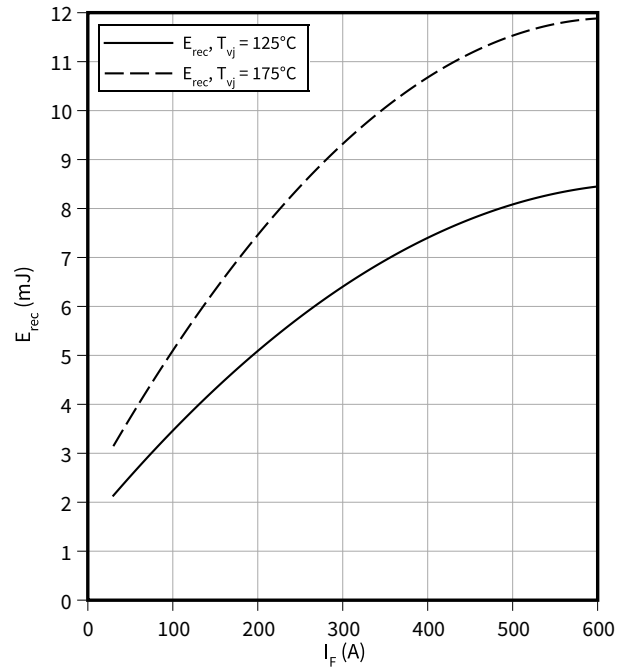

Switching losses (typical), Diode, D5 / D6

$E_{rec} = f(R_G)$

$I_F = 300\text{ A}, V_{CC} = 500\text{ V}$

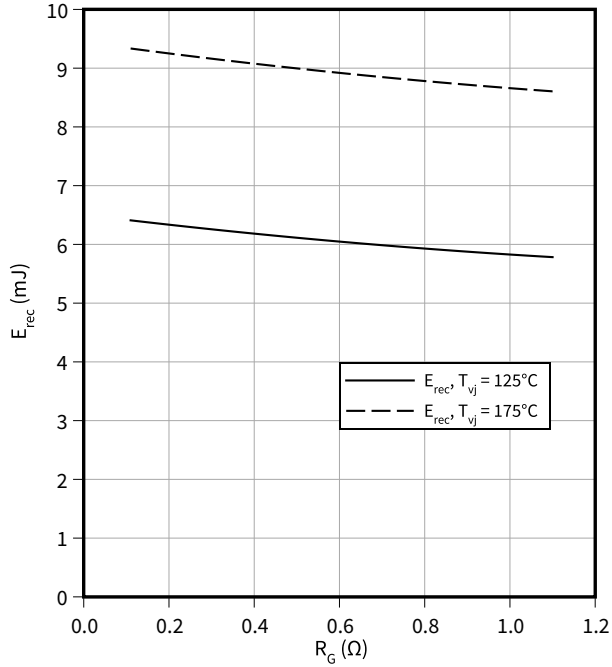

Transient thermal impedance, Diode, D5 / D6

$Z_{th} = f(t)$

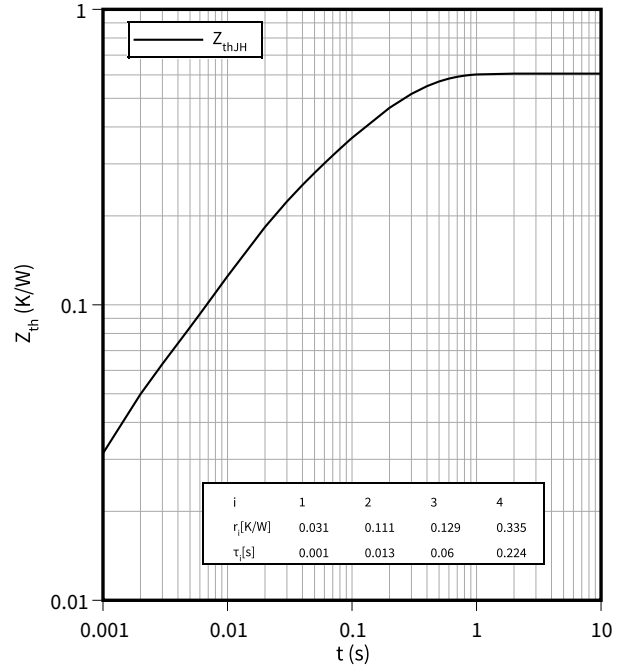

Temperature characteristic (typical), NTC-Thermistor

$R = f(T_{NTC})$

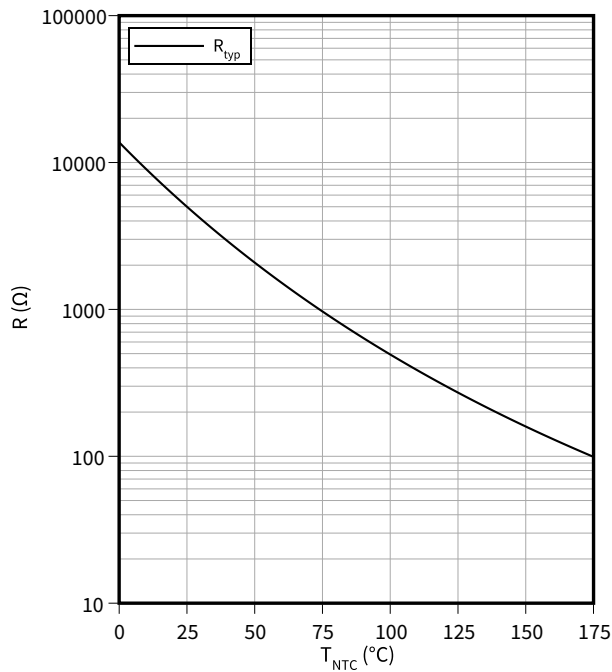

9 Circuit diagram

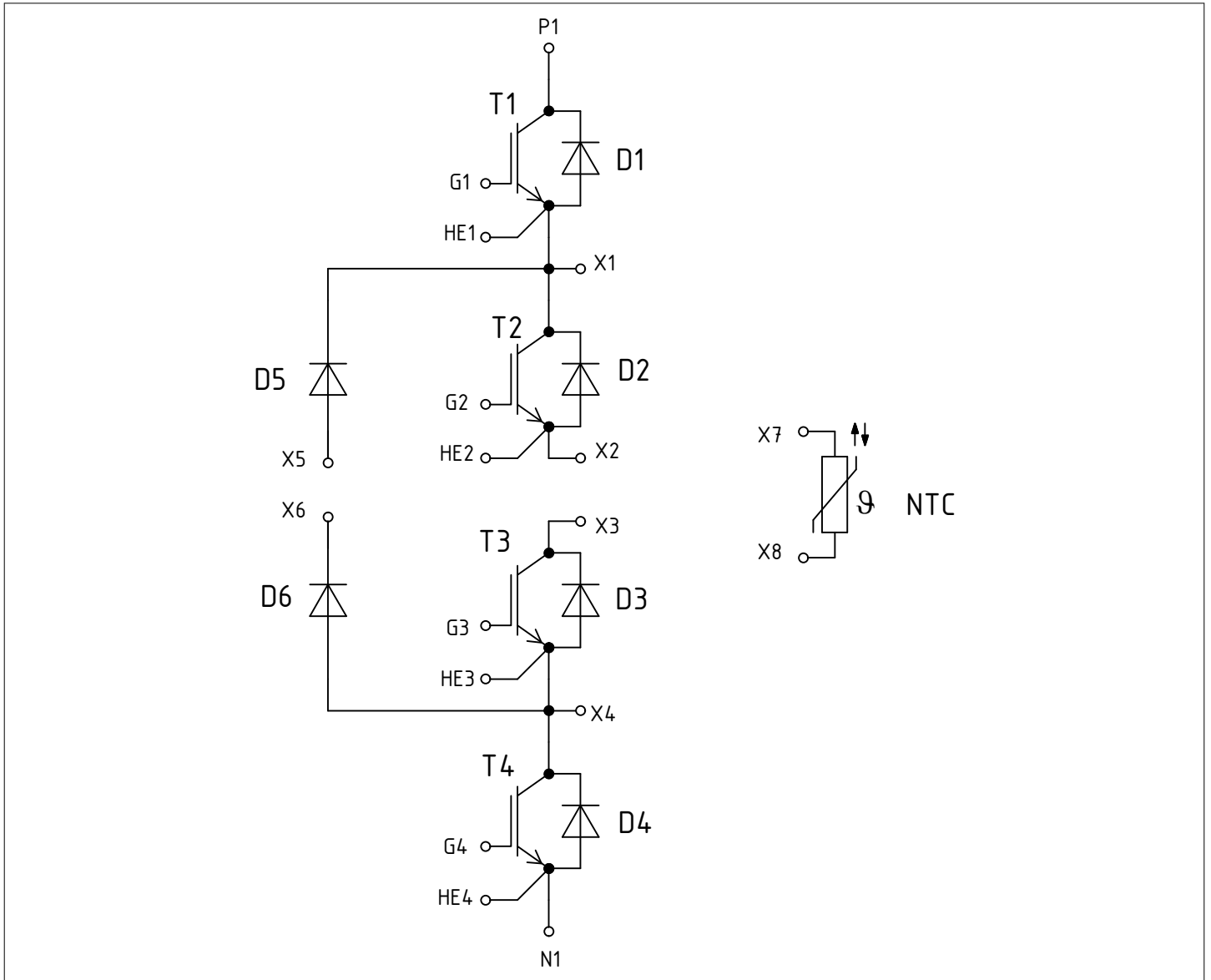

Figure 1

10 Package outlines

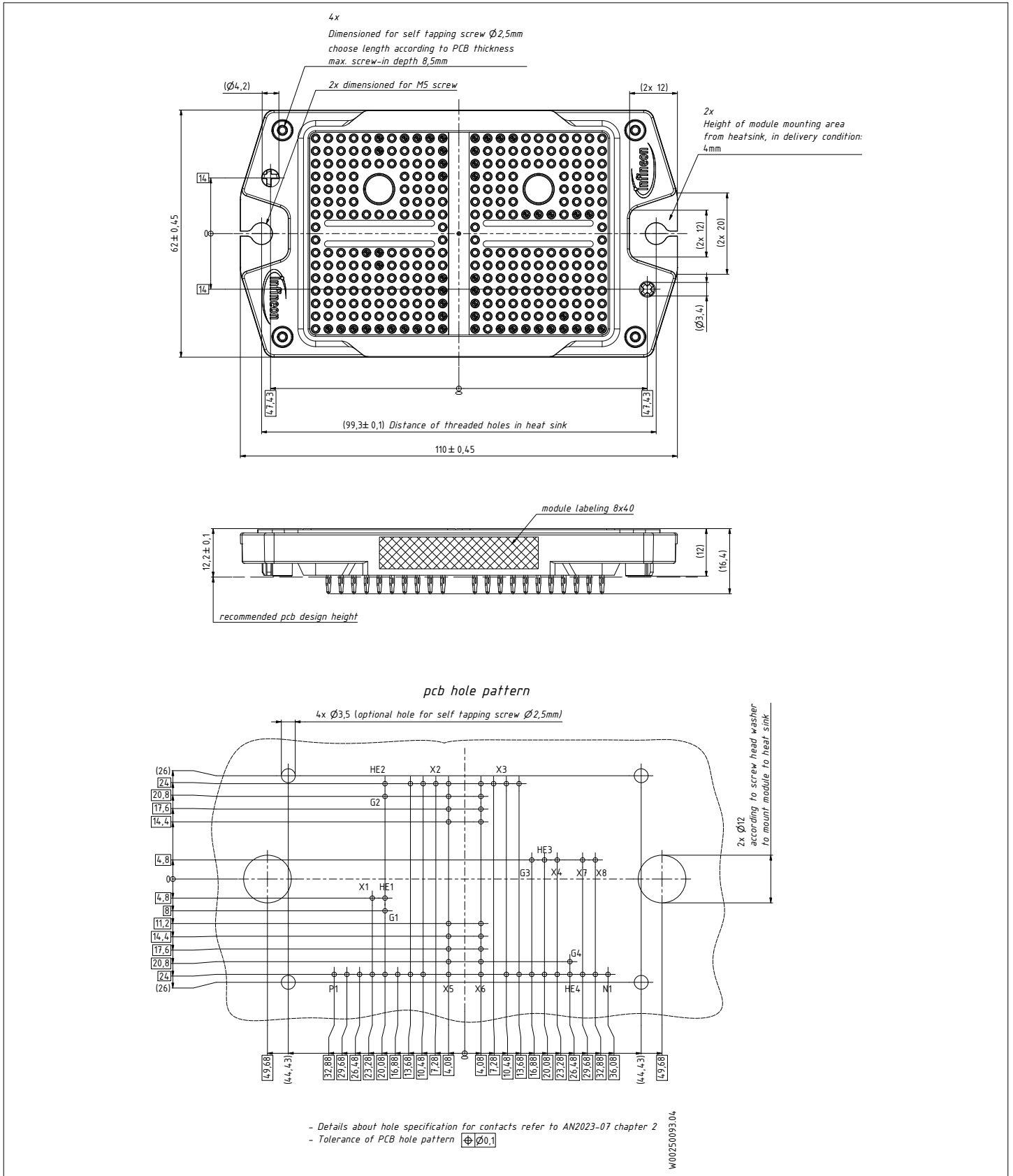

Figure 2

11 Module label code

Module label code			
Code format	Data Matrix	Barcode Code128	
Encoding	ASCII text	Code Set A	
Symbol size	16x16	23 digits	
Standard	IEC24720 and IEC16022	IEC8859-1	
Code content	<i>Content</i>	<i>Digit</i>	<i>Example</i>
	Module serial number	1 - 5	71549
	Module material number	6 - 11	142846
	Production order number	12 - 19	55054991
	Date code (production year)	20 - 21	15
	Date code (production week)	22 - 23	30
Example	 		
	71549142846550549911530		71549142846550549911530

Figure 3

Revision history

Document version	Date of release	Description of changes
0.10	2024-08-09	Initial version
1.00	2024-12-04	Final datasheet

Trademarks

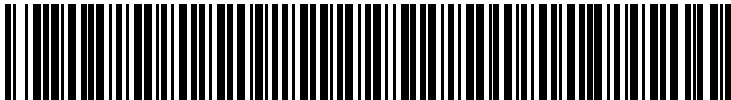
All referenced product or service names and trademarks are the property of their respective owners.

Edition 2024-12-04

Published by

Infineon Technologies AG

81726 Munich, Germany

© 2024 Infineon Technologies AG

All Rights Reserved.

Do you have a question about any aspect of this document?

Email: erratum@infineon.com

Document reference

IFX-ABK797-002

Important notice

The information given in this document shall in no event be regarded as a guarantee of conditions or characteristics ("Beschaffheitsgarantie").

With respect to any examples, hints or any typical values stated herein and/or any information regarding the application of the product, Infineon Technologies hereby disclaims any and all warranties and liabilities of any kind, including without limitation warranties of non-infringement of intellectual property rights of any third party.

In addition, any information given in this document is subject to customer's compliance with its obligations stated in this document and any applicable legal requirements, norms and standards concerning customer's products and any use of the product of Infineon Technologies in customer's applications.

The data contained in this document is exclusively intended for technically trained staff. It is the responsibility of customer's technical departments to evaluate the suitability of the product for the intended application and the completeness of the product information given in this document with respect to such application.

Warnings

Due to technical requirements products may contain dangerous substances. For information on the types in question please contact your nearest Infineon Technologies office.

Except as otherwise explicitly approved by Infineon Technologies in a written document signed by authorized representatives of Infineon Technologies, Infineon Technologies' products may not be used in any applications where a failure of the product or any consequences of the use thereof can reasonably be expected to result in personal injury.