

KEV-BS SERIES

THREE PHASE VERY HIGH PERFORMANCE EMI FILTER

BOOKSHELF TYPE DUAL STAGE WYE CONFIGURATION

INTRODUCTION

High performance filters with bookshelf design are designed for motor drive applications requiring minimum space and convenient installation with very high performance at significant interference levels.

APPLICATION

- AC/DC Drives
- HVAC
- Robotics
- UPS

FEATURES

- Very High-Performance Dual Stage
- Bookshelf Design With Neutral
- Compact / Light Weight / Cost Effective

APPROVALS AND COMPLIANCE

- UL Recognised
- CSA Certified



STANDARD



NEW-DIN RAIL

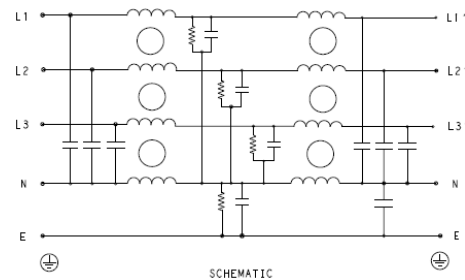

Specifications

Electrical Characteristics	
Maximum Continuous Operating Voltage	440/520VAC
Current Ratings	7A to 150A @40°C, Din Mount 7A to 100A @40°C
Operating Frequency	50/60Hz
High Potential Test Voltage -440VAC	Line to Ground 2632VDC for 1 Minute
	Line to Line 1892VDC for 1 Minute
High Potential Test Voltage -520VAC	Line to Ground 2856VDC for 1 Minute
	Line to Line 2236VDC for 1 Minute
Overload Capability	135% of Rated current for 15 minutes

KEV-BS Series

Three Phase Very High Performance EMI Filter

Functional Characteristics	
Operating Temperature Range	-25°C to +85°C
Climatic Category	25/85/21
Termination (Depends on Current Rating)	Shock Proof
Flammability Corresponding to	UL 94 V-0

Reference Standards	
Design Corresponding to	UL 60939-3 and CSA 22.2 No.8-13

Selection Table - Standard Version



TE Ordering Number	Catalog Number	Rated Current @40°C	Rated Voltage @40°C	Leakage Current (mA)	Weight (Kgs)	Termination
2-1609998-0	7KEVD10ABSW	7A	440 VAC	5	1.5	4
2-1609998-1	16KEVD10ABSW	16A	440 VAC	5	2	4
2-1609998-2	30KEVD10ABSW	30A	440 VAC	5	2.2	4
2-1609998-3	42KEVD10ABSW	42A	440 VAC	11	3	10
2-1609998-4	55KEVD10ABSW	55A	440 VAC	11	3	10
2-1609998-5	75KEVD10ABSW	75A	440 VAC	11	4	16
2-1609998-6	100KEVD10ABSW	100A	440 VAC	11	4	25
2-1609998-7	125KEVD10ABSW	125A	440 VAC	11	8	50
2-1609998-8	150KEVD10ABSW	150A	440 VAC	11	10	50
5-1609998-0	7KEVD10BBSW	7A	520 VAC	5	1.5	4
5-1609998-1	16KEVD10BBSW	16A	520 VAC	5	2	4
5-1609998-2	30KEVD10BBSW	30A	520 VAC	5	2.2	4
5-1609998-3	42KEVD10BBSW	42A	520 VAC	11	3	10
5-1609998-4	55KEVD10BBSW	55A	520 VAC	11	3	10
5-1609998-5	75KEVD10BBSW	75A	520 VAC	11	4	16
5-1609998-6	100KEVD10BBSW	100A	520 VAC	11	4	25
5-1609998-7	125KEVD10BBSW	125A	520 VAC	11	8	50
5-1609998-8	150KEVD10BBSW	150A	520 VAC	11	10	50

KEV-BS Series

Three Phase Very High Performance EMI Filter

Selection Table - Din Rail Mount



NEW

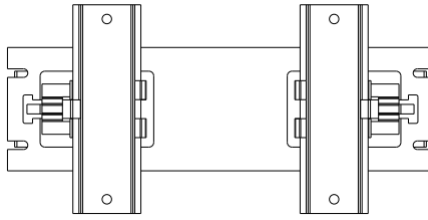

VERTICAL MOUNT

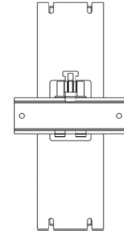

HORIZONTAL MOUNT

Note: Din Rail not supplied

TE Ordering Number	Part Number	Din Type	Rated Current @40°C	Rated Voltage @40°C	Leakage Current (mA)	Weight (Kgs)	Termination 
3-1609998-0	7KEVD10ABSWHM	HORIZONTAL	7A	440 VAC	5	1.6	4
3-1609998-1	16KEVD10ABSWHM	HORIZONTAL	16A	440 VAC	5	2.1	4
3-1609998-2	30KEVD10ABSWHM	HORIZONTAL	30A	440 VAC	5	2.3	4
3-1609998-3	7KEVD10ABSWVM	VERTICAL	7A	440 VAC	5	1.7	4
3-1609998-4	16KEVD10ABSWVM	VERTICAL	16A	440 VAC	5	2.2	4
3-1609998-5	30KEVD10ABSWVM	VERTICAL	30A	440 VAC	5	2.4	4
3-1609998-6	42KEVD10ABSWHM	HORIZONTAL	42A	440 VAC	11	3.2	10
3-1609998-7	55KEVD10ABSWHM	HORIZONTAL	55A	440 VAC	11	3.2	10
3-1609998-8	75KEVD10ABSWHM	HORIZONTAL	75A	440 VAC	11	4.2	16
3-1609998-9	100KEVD10ABSWHM	HORIZONTAL	100A	440 VAC	11	4.2	25
6-1609998-0	7KEVD10BBSWHM	HORIZONTAL	7A	520 VAC	5	1.6	4
6-1609998-1	16KEVD10BBSWHM	HORIZONTAL	16A	520 VAC	5	2.1	4
6-1609998-2	30KEVD10BBSWHM	HORIZONTAL	30A	520 VAC	5	2.3	4
6-1609998-3	7KEVD10BBSWVM	VERTICAL	7A	520 VAC	5	1.7	4
6-1609998-4	16KEVD10BBSWVM	VERTICAL	16A	520 VAC	5	2.2	4
6-1609998-5	30KEVD10BBSWVM	VERTICAL	30A	520 VAC	5	2.4	4
6-1609998-6	42KEVD10BBSWHM	HORIZONTAL	42A	520 VAC	11	3.2	10
6-1609998-7	55KEVD10BBSWHM	HORIZONTAL	55A	520 VAC	11	3.2	10
6-1609998-8	75KEVD10BBSWHM	HORIZONTAL	75A	520 VAC	11	4.2	16
6-1609998-9	100KEVD10BBSWHM	HORIZONTAL	100A	520 VAC	11	4.2	25

KEV-BS Series

Three Phase Very High Performance EMI Filter

Connectors Cross Section

	4	10	16	25	50
Wire Section (mm ²)	4mm ²	10 mm ²	16 mm ²	25 mm ²	50 mm ²
Wire Section (AWG)	12AWG	8 AWG	6 AWG	4 AWG	1/0 AWG
Wire Stripping	max 10mm	max 13.5 mm	max 17 mm	max 17 mm	max 20 mm
Max Recommended Torque	0.5 Nm/4.5 in.lbs	1.2 Nm/10.8 in.lbs	2-2.2 Nm/18-19.8 in.lbs	2 Nm/18 in.lbs	6 Nm/54 in.lbs

Insertion Loss (Typical) – Measured in Closed 50Ω System

		Common Mode 50Ω/50Ω								
		Frequency in MHz								
		0.01	0.05	0.15	0.5	1	3	5	10	30
Current Rating	7A	70	70	72	78	72	62	54	45	25
	16A	72	70	68	70	74	65	58	46	24
	30A	49	50	60	79	77	64	56	48	34
	42A	50	50	61	75	78	65	57	46	32
	55A	41	40	26	30	32	50	52	49	22
	75A	42	40	28	32	35	51	50	46	21
	100A	40	37	42	32	36	48	50	46	20
	125A	39	41	50	66	60	50	45	37	17
	150A	31	33	44	61	56	47	43	36	21

		Differential Mode 50Ω/50Ω								
		Frequency in MHz								
		0.01	0.05	0.15	0.5	1	3	5	10	30
Current Rating	7A	50	52	36	50	50	46	40	26	30
	16A	56	50	38	51	52	48	42	28	32
	30A	31	34	48	83	80	57	45	23	25
	42A	32	32	50	80	75	72	46	26	22
	55A	30	35	20	22	34	45	48	26	27
	75A	40	38	25	21	34	46	48	30	24
	100A	45	40	50	25	32	50	47	32	22
	125A	49	50	54	53	45	33	26	19	19
	150A	44	45	43	56	47	33	27	22	22

KEV-BS Series

Three Phase Very High Performance EMI Filter

Common Mode Insertion Loss (Typical in dB - Refer to table above)

7A

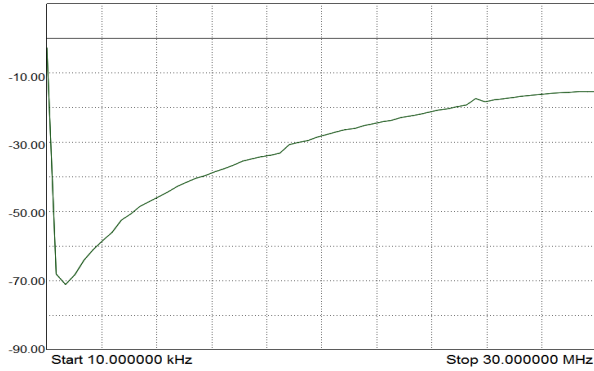

16A

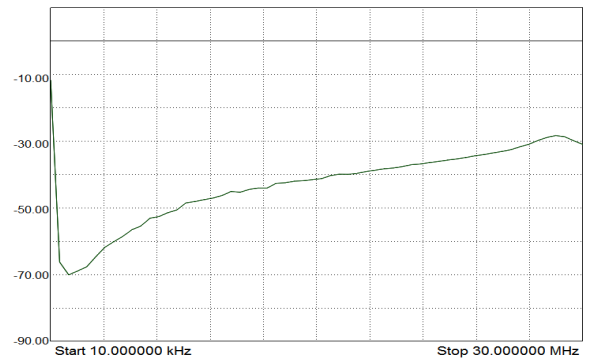

30A

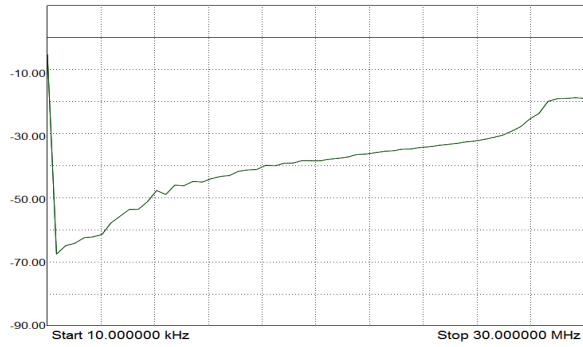

42A

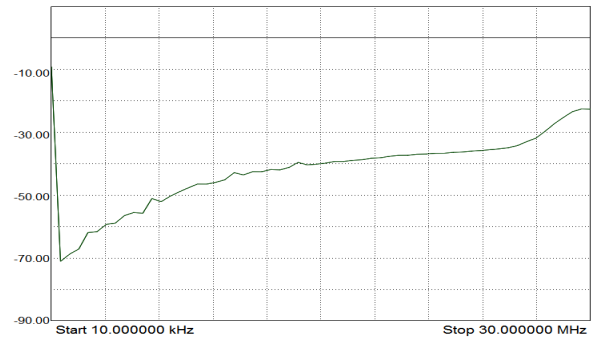

55A

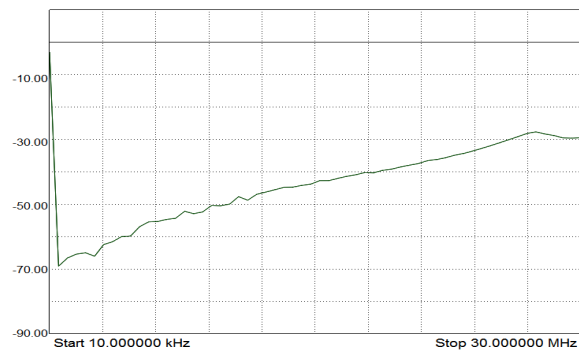

75A

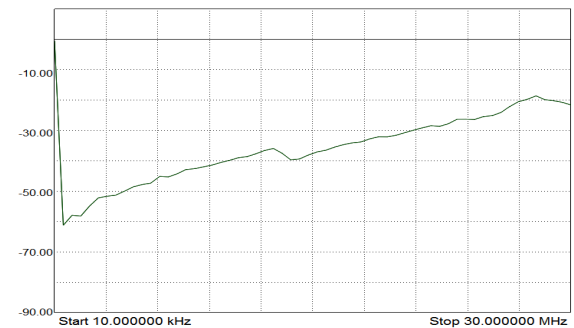

KEV-BS Series

Three Phase Very High Performance EMI Filter

Common Mode Insertion Loss (Typical in dB - Refer to table above)

100A

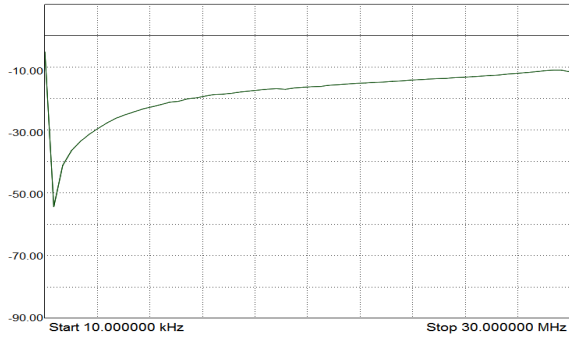

120A

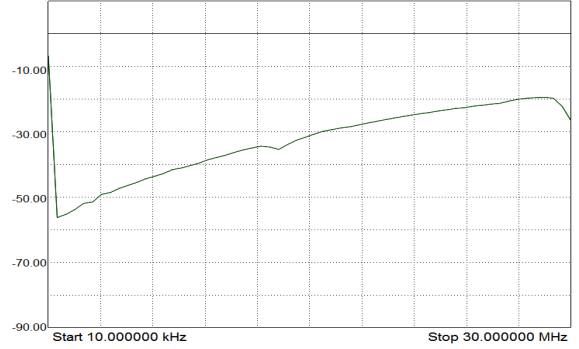

150A

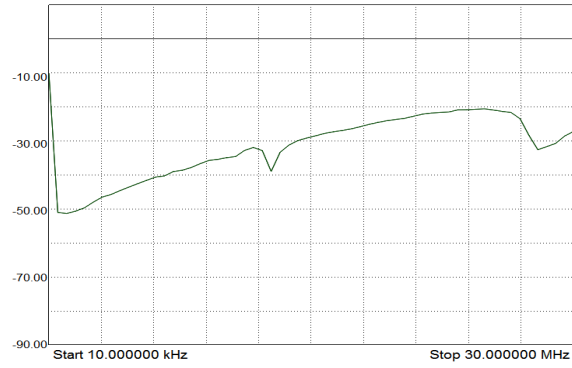

KEV-BS Series

Three Phase Very High Performance EMI Filter

Case Dimensions - Standard Version

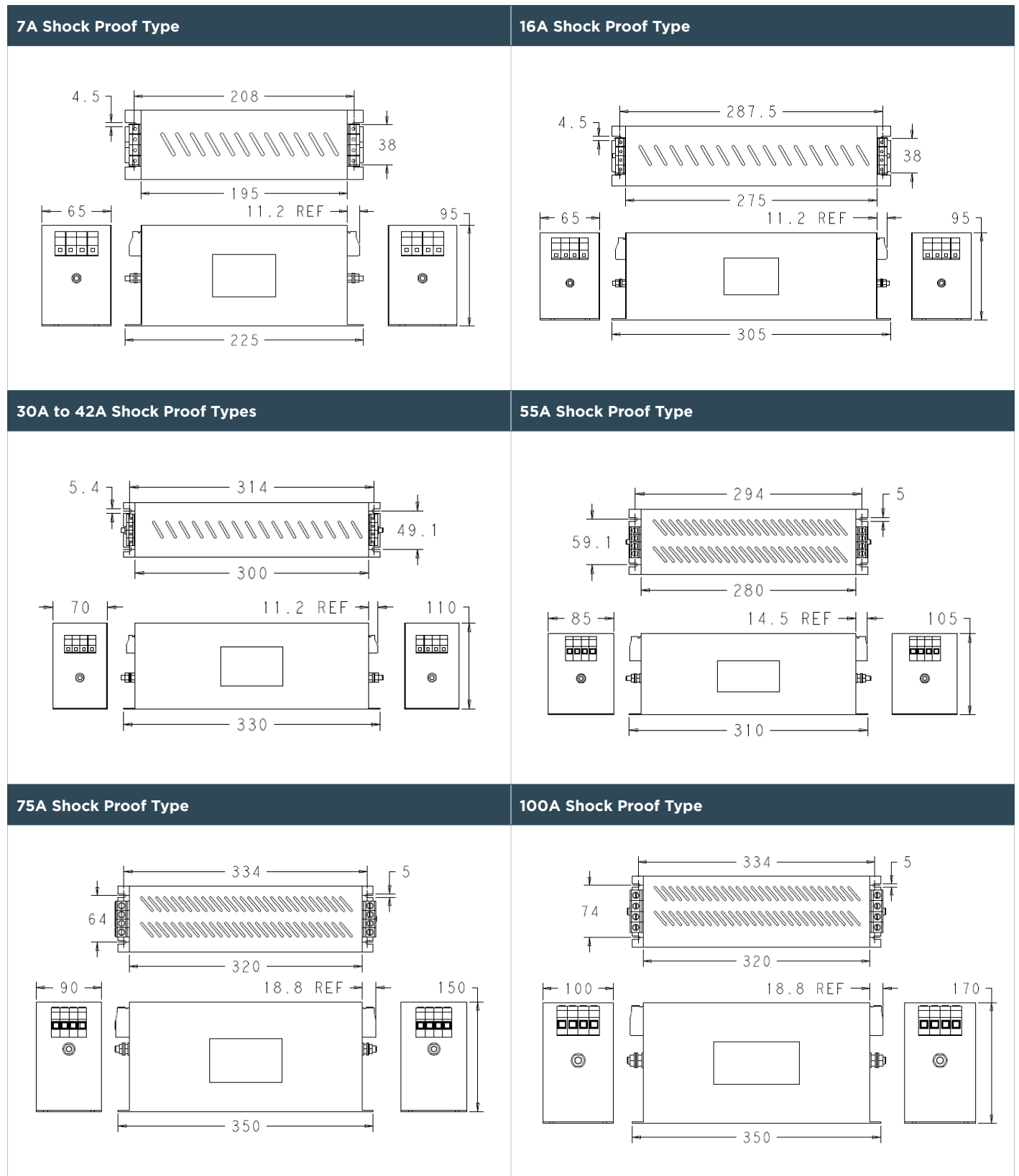

KEV-BS Series

Three Phase Very High Performance EMI Filter

Case Dimensions - Standard Version

125A to 150A Types

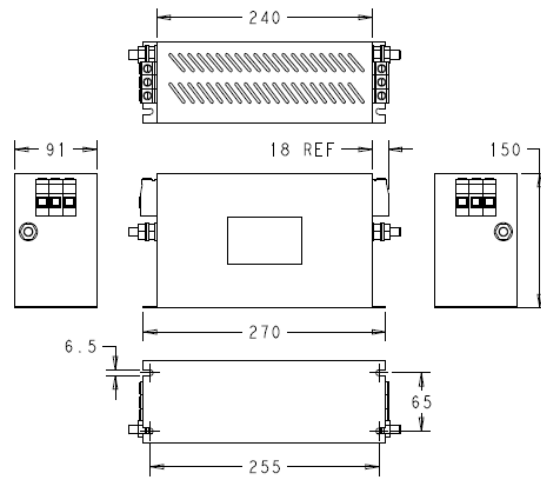

KEV-BS Series

Three Phase Very High Performance EMI Filter

Case Dimensions - Din Rail Mount

7A Shock Proof Type - Horizontal Mount

Note: Din Rail not supplied

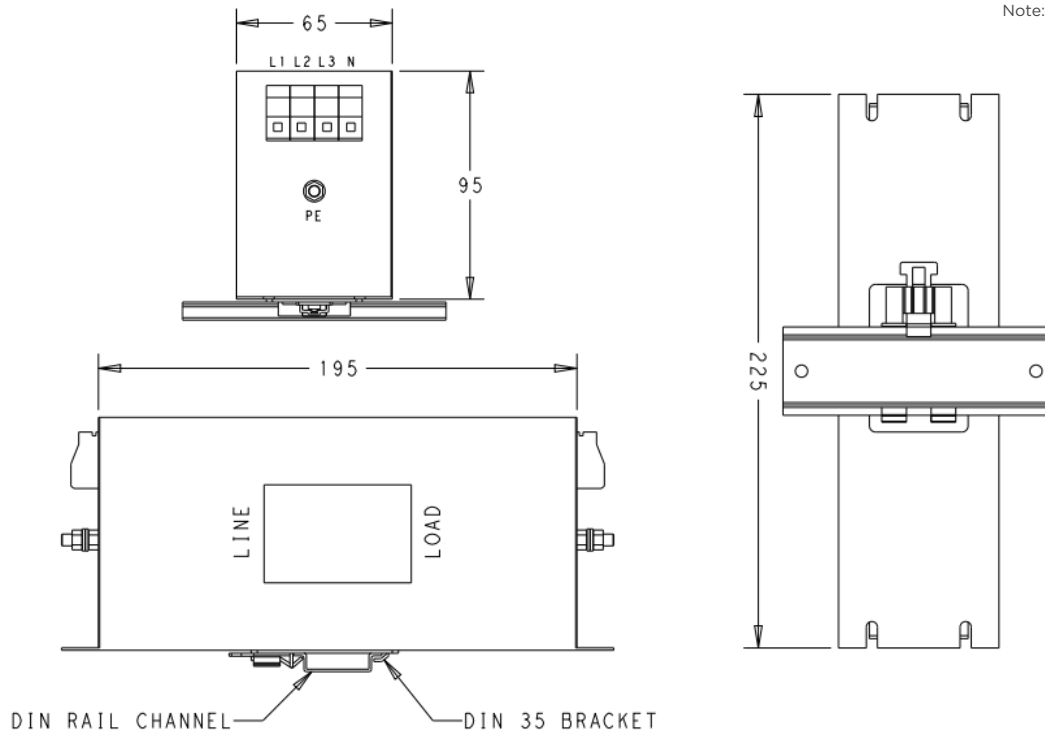

7A Shock Proof Type - Vertical Mount

Note: Din Rail not supplied

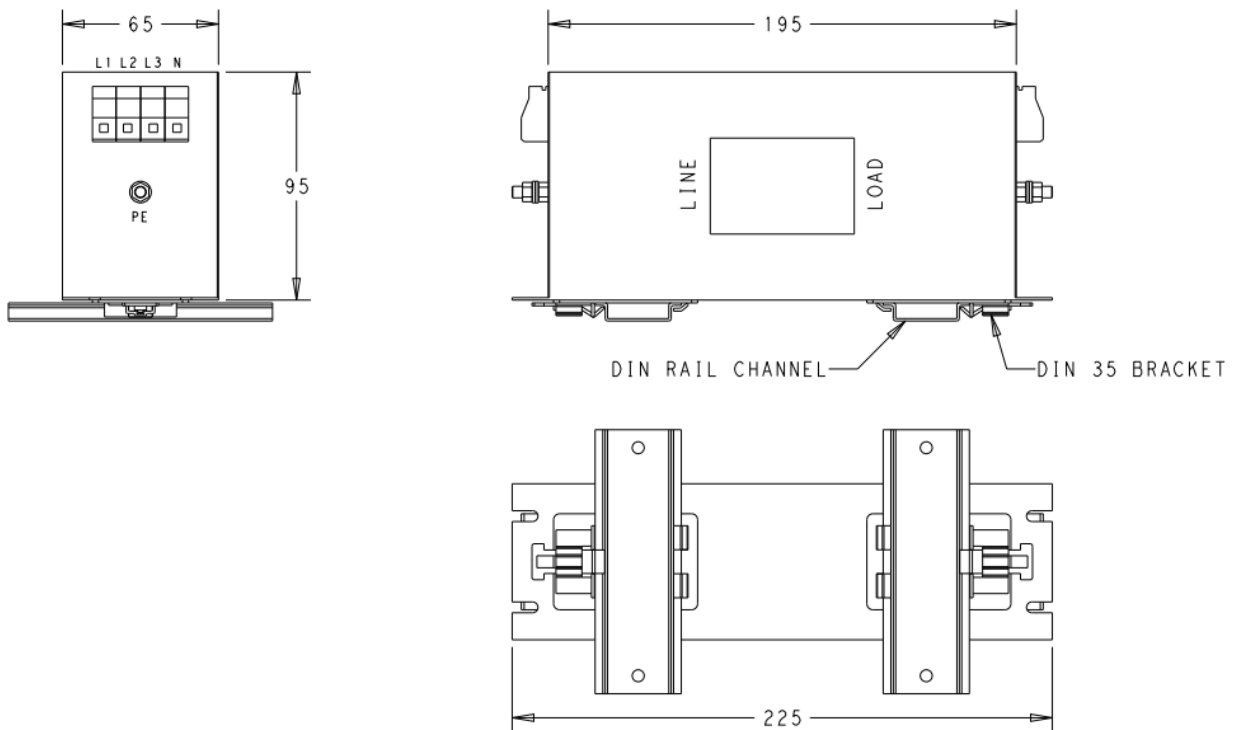

KEV-BS Series

Three Phase Very High Performance EMI Filter

Case Dimensions - Din Rail Mount

16A Shock Proof Type - Horizontal Mount

Note: Din Rail not supplied

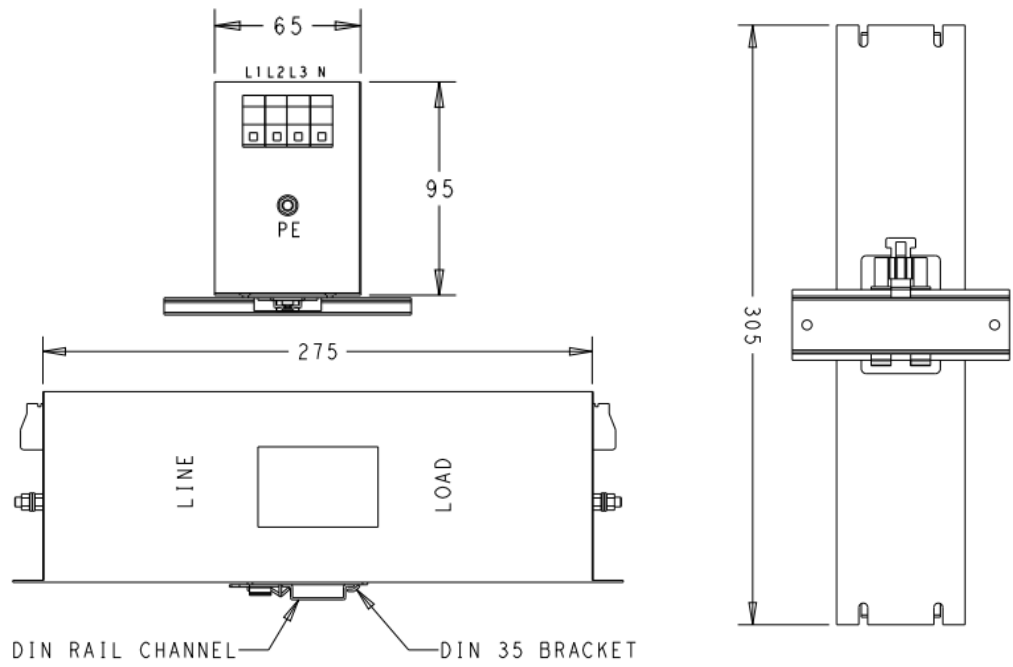

16A Shock Proof Type - Vertical Mount

Note: Din Rail not supplied

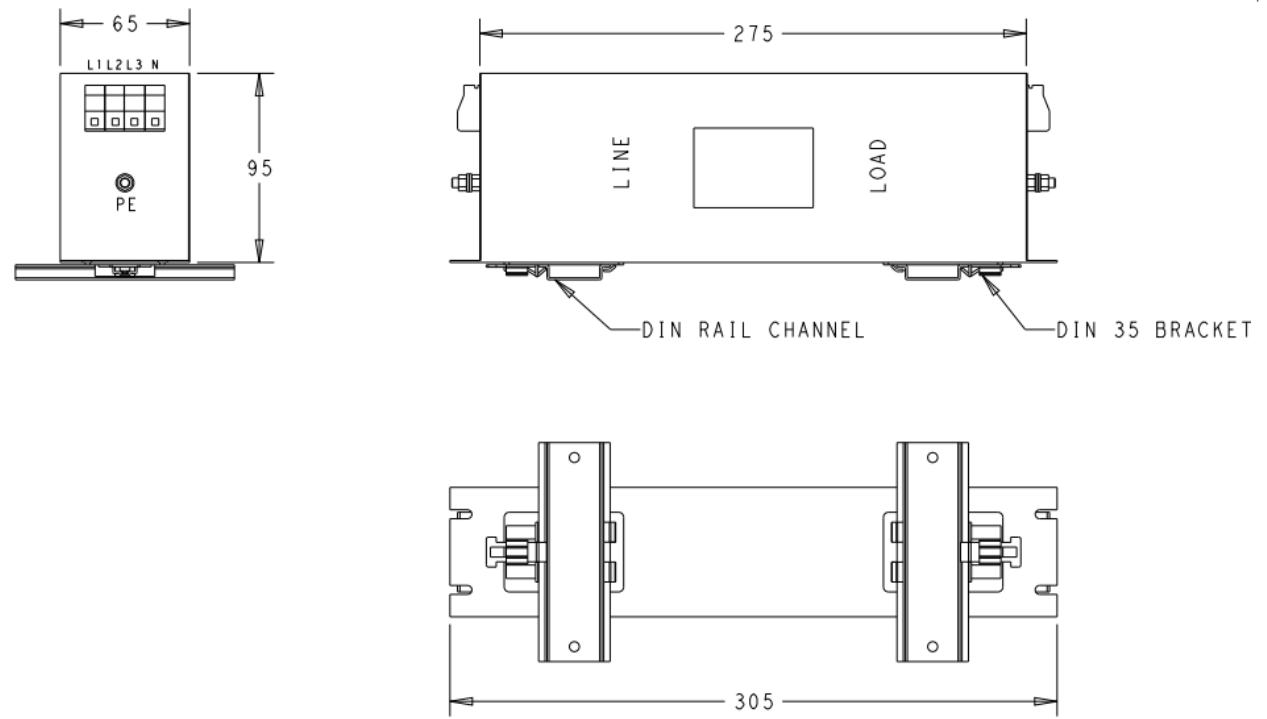

KEV-BS Series

Three Phase Very High Performance EMI Filter

Case Dimensions - Din Rail Mount

30A Shock Proof Type - Horizontal Mount

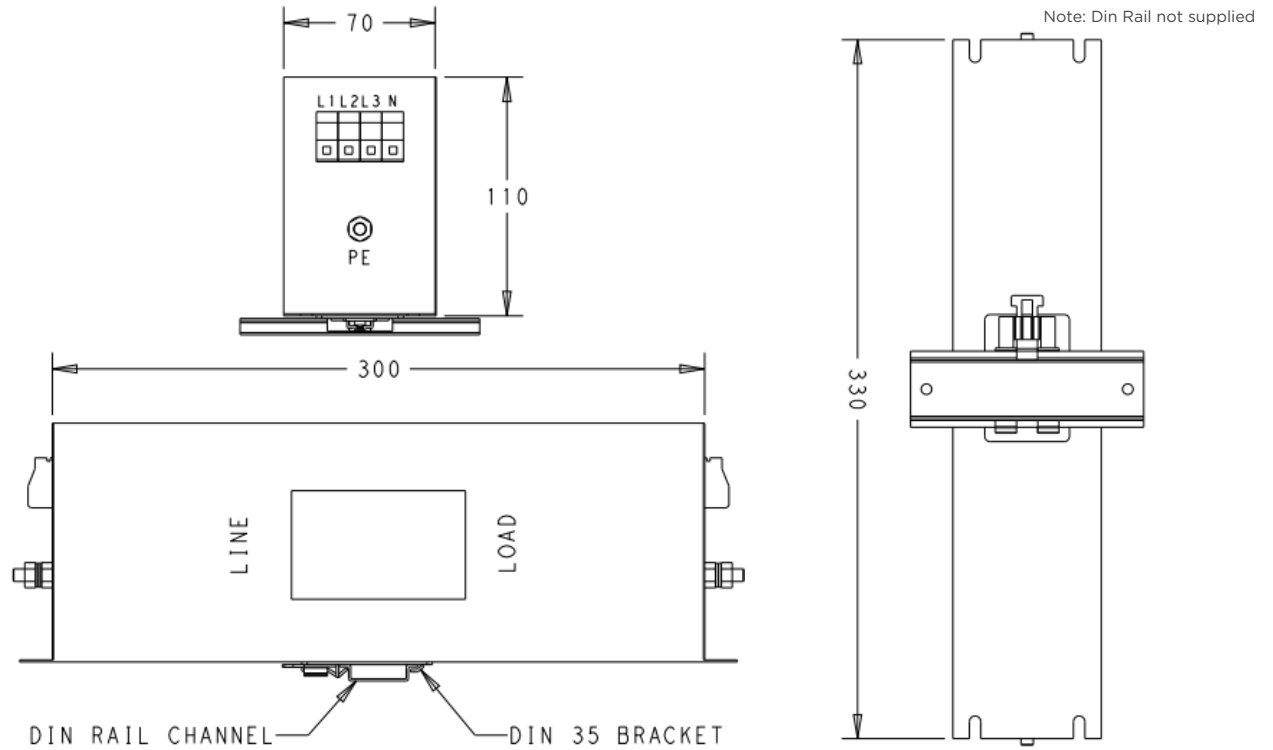

30A Shock Proof Type - Vertical Mount

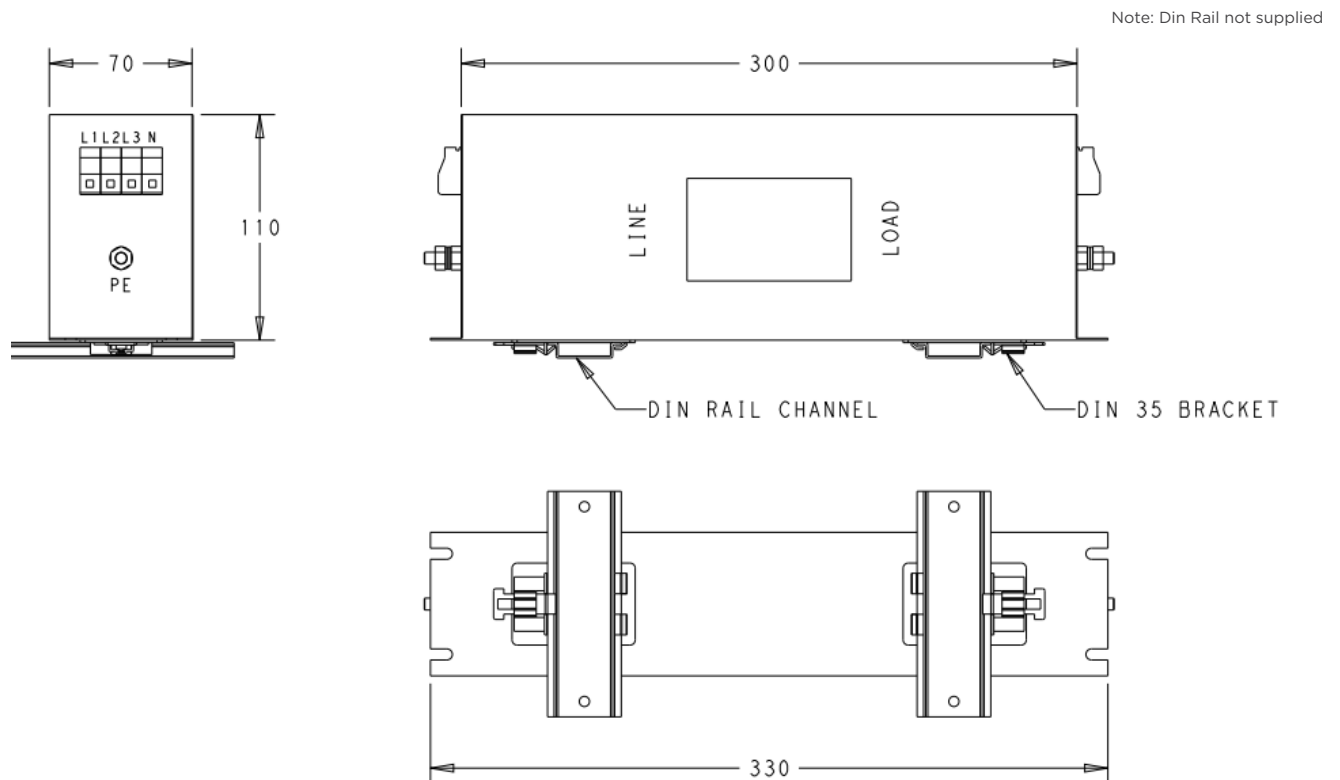

KEV-BS Series

Three Phase Very High Performance EMI Filter

Case Dimensions - Din Rail Mount

42A Shock Proof Type - Horizontal Mount

Note: Din Rail not supplied

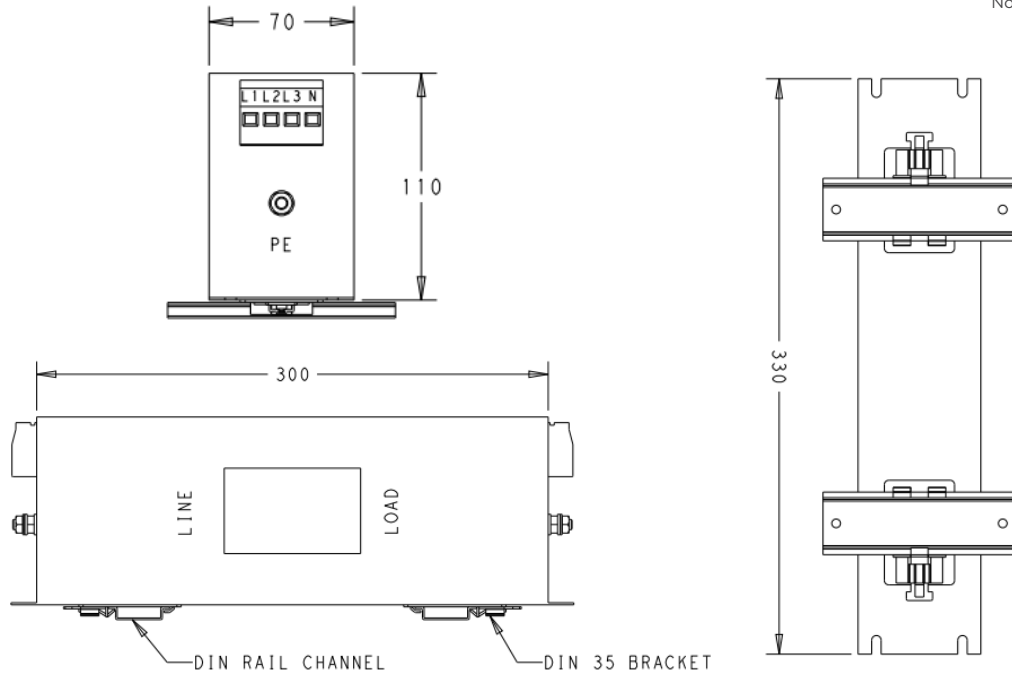

55A Shock Proof Type - Horizontal Mount

Note: Din Rail not supplied

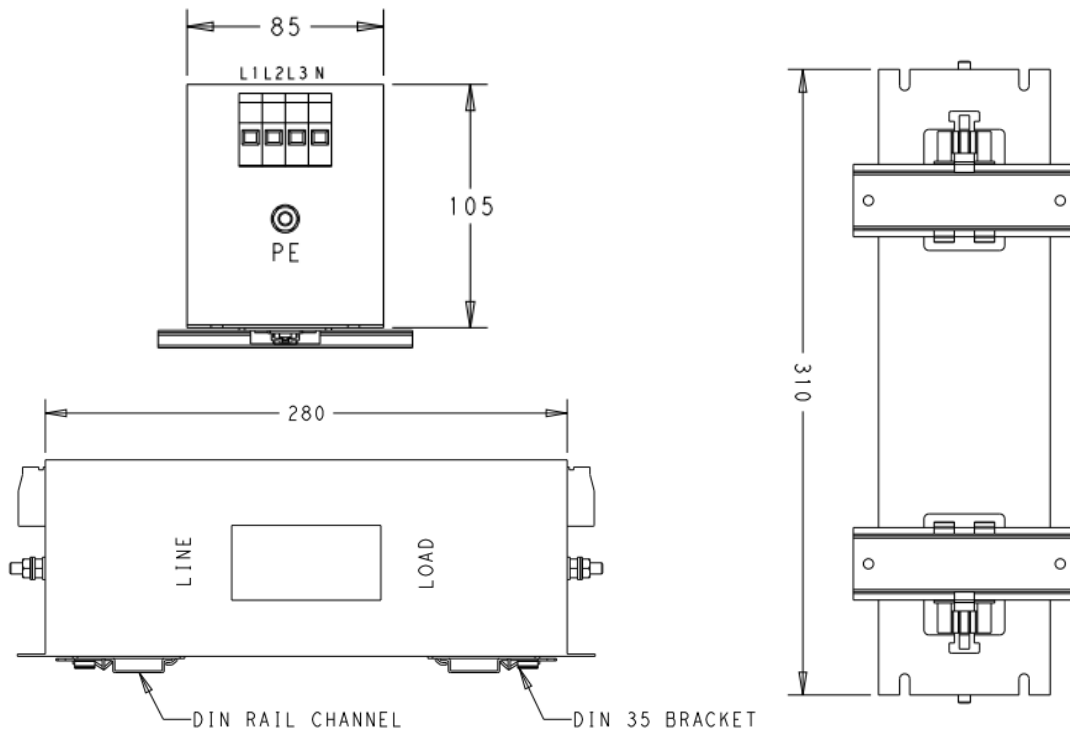

KEV-BS Series

Three Phase Very High Performance EMI Filter

Case Dimensions - Din Rail Mount

75A Shock Proof Type - Horizontal Mount

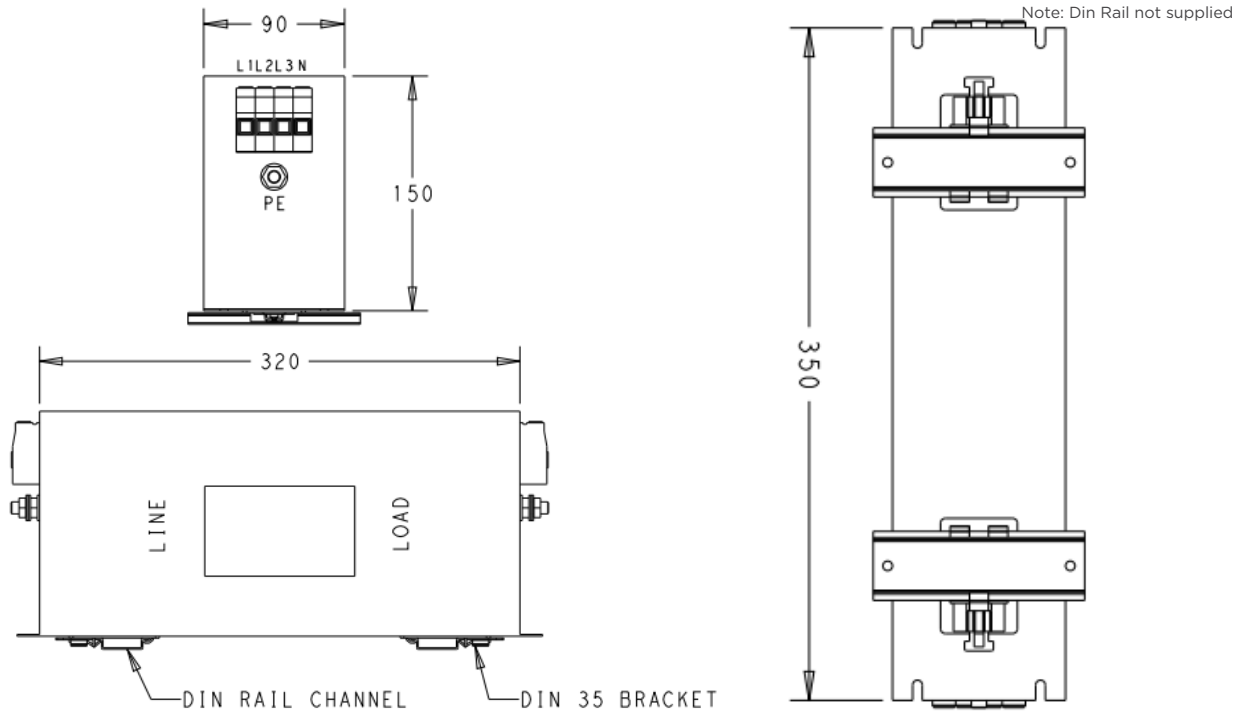

100A Shock Proof Type - Horizontal Mount

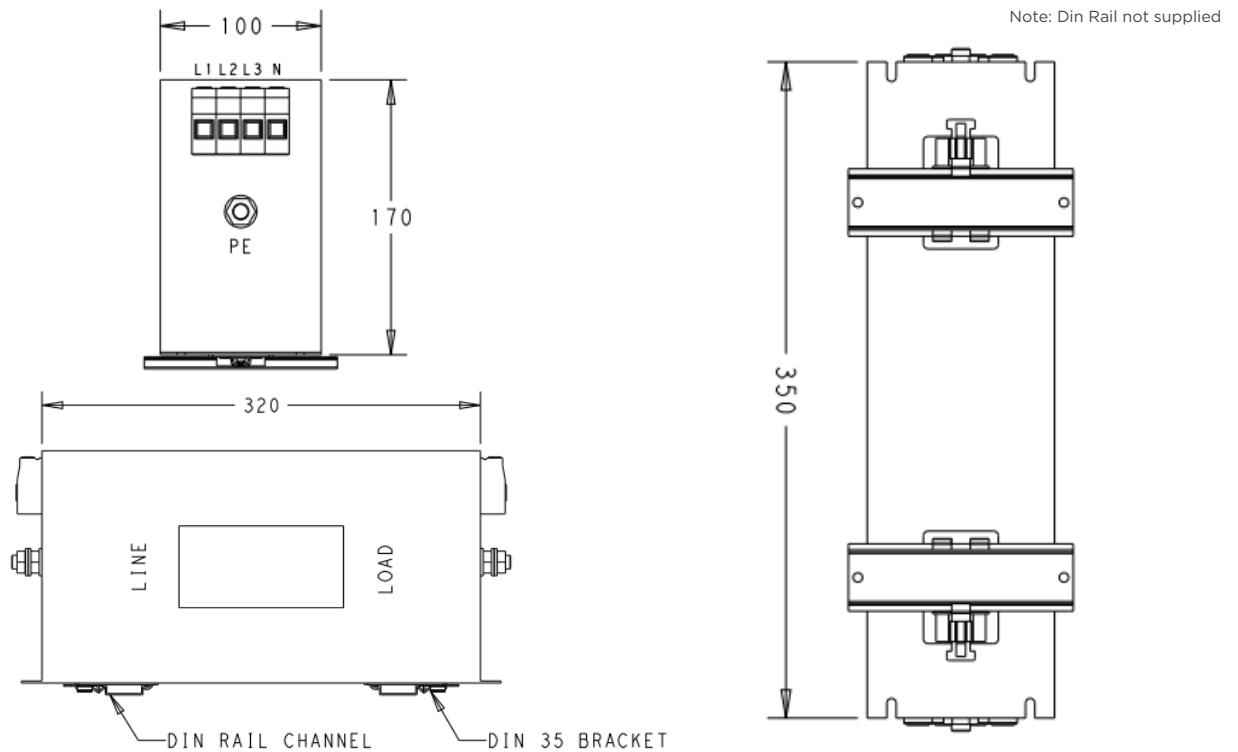

All dimensions in mm; Tolerances according: ISO2768-m

HOW TO ORDER

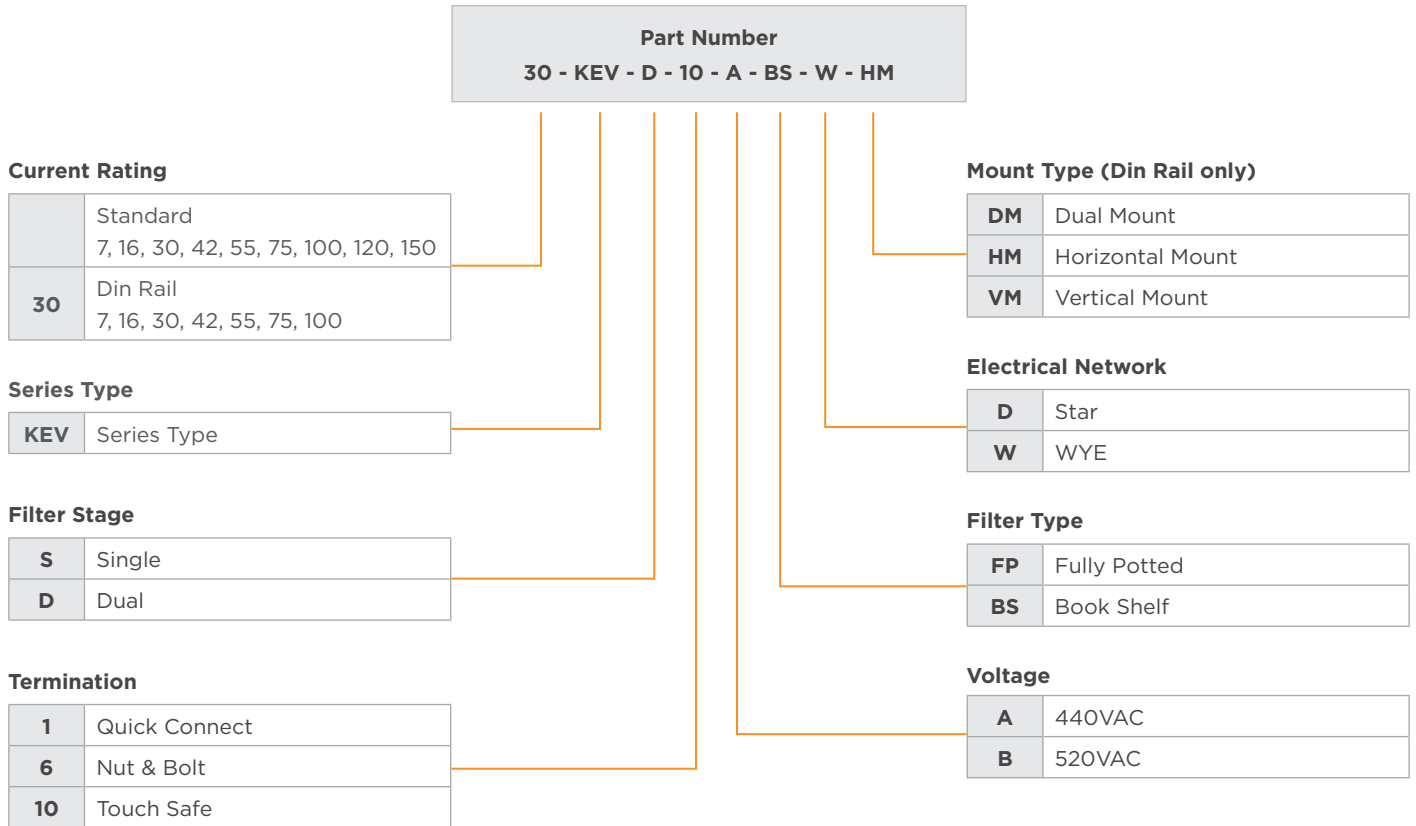

te.com

©2022 TE Connectivity. All Rights Reserved.

TE Connectivity, TE Connectivity (logo) and Every Connection Counts are trademarks. All other logos, products and/or company names referred to herein might be trademarks of their respective owners.

The information given herein, including drawings, illustrations and schematics which are intended for illustration purposes only, is believed to be reliable. However, TE Connectivity makes no warranties as to its accuracy or completeness and disclaims any liability in connection with its use. TE Connectivity's obligations shall only be as set forth in TE Connectivity's Standard Terms and Conditions of Sale for this product and in no case will TE Connectivity be liable for any incidental, indirect or consequential damages arising out of the sale, resale, use or misuse of the product. Users of TE Connectivity products should make their own evaluation to determine the suitability of each such product for the specific application.

12/22 ED