

## Specification

Part Number: **iDAS.W.001**

Product Name: iDAS LTE MIMO Wall Mount Panel Antenna

Features: 2\*LTE MIMO Antenna for Indoor Distributed Antenna Systems

High Performance, Low PIM Antenna

Wall Mounted Rectangular Panel Design

Covers Worldwide LTE Bands (Including 3G/2G)

698-960MHz / 1710-2170MHz / 2500-2690MHz

IP54 Rated Enclosure

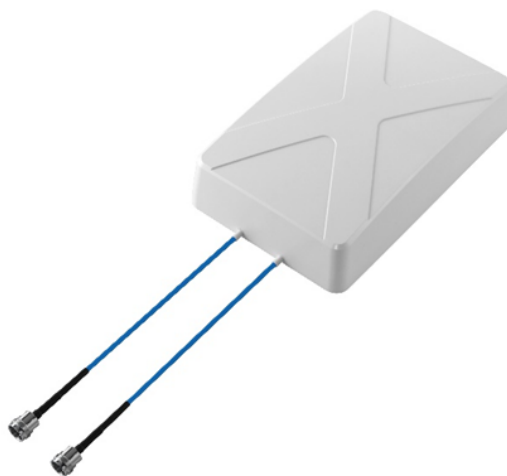
Cables: 300mm Low Loss Plenum Rated RG-402 Equivalent

Connector: 4.3-10 mini-DIN [F]

Fully customizable cables and connectors

Dimensions: 308 \* 190 \* 72mm

**RoHS Compliant**



## 1. Introduction

This Taoglas iDAS LTE MIMO antenna is a compact antenna with high performance and low Passive Inter-Modulation (PIM) designed for use in Indoor Distributed Antenna Systems (iDAS) to address in-building coverage issues and the increasing demand for constant connectivity.

The iDAS delivers powerful worldwide 4G LTE MIMO coverage while also covering the 3G and 2G bands and features a compact, easy-to-install wall mounted bracket.

iDAS networks are an excellent solution to bring LTE coverage to areas traditional base stations cannot reach, for example;

- Stadiums, Arenas, Convention Centres
- Hotels, Shopping Malls, Hospitals
- Factories, Warehouses
- Airports, Train Stations, Bus Stations
- Schools, College Campuses
- Office Buildings, High Density Residential Complexes

LTE 4G applications demand high speed data uplink and downlink. High efficiency and high gain MIMO antennas are necessary to achieve the signal to noise ratio and throughput required to solve these challenges. The iDAS antenna is also designed for high isolation and low PIM between the two MIMO antennas to prevent self-interference. Low loss plenum rated cables are used to keep efficiency high while complying with stringent fire rating standards.

The product ships with an RG-402 equivalent plenum rated cable with a temperature spec of up to 150C. The PTFE/FEP jacket is flexible yet chemical and fire resistant. Taoglas offers customizable cable lengths, cable types and connector types, contact your regional Taoglas sales office for support.

## 2. Specification

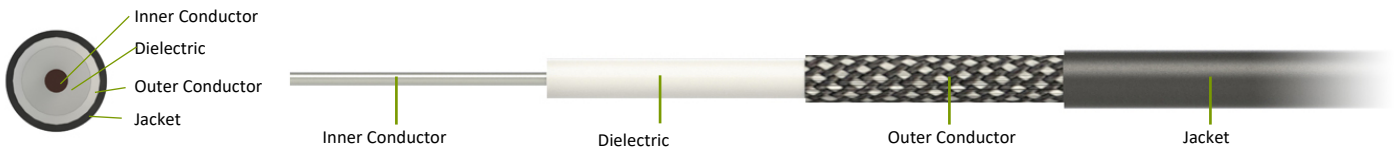
### 2.1. Antenna Specifications

Electrical							
Band		LTE 700	GSM	DCS	PCS	UMTS	LTE2600
		Band 12,13	850/900	1800	1900	1700/1800 1900/2100	Band 7
Frequency (MHz)	Port	699~756	824~960	1710~1880	1850~1990	1710~2170	2500~2690
Peak Gain (dBi)	1	7.2	7.1	7.0	7.1	7.0	7.1
	2	7.0	7.6	7.0	7.2	7.0	7.3
Average Gain (dB)	1	-0.6	-0.8	-1.2	-1.1	-1.0	-1.0
	2	-0.7	-0.8	-1.2	-1.1	-1.0	-1.0
Efficiency (%)	1	86	83	75	77	79	79
	2	85	83	76	78	79	79
Return Loss (dB)	1	-17	-17	-21	-20	-22	-23
	2	-15	-17	-22	-21	-22	-22
Front to Back Ratio	1	17	19	14	17	22	20
	2	16	17	16	18	21	19
Horizontal HPBW (degrees)	1	88	80	72	71	82	83
	2	85	78	87	82	83	74
Vertical HPBW (degrees)	1	72	64	68	71	69	66
	2	71	60	57	64	66	73
Impedance	50 Ω						
Polarisation	Linear (+45/-45 degree)						
Radiation Pattern	Directional						
Frequency (MHz)	699~756	824~960	1710~1880	1850~1990	1710~2170	2500~2900	
PIM Avg. Rating @ 2*43dBm	-161dBc			-160dBc			
PIM Max. Rating @ 2*43dBm	-153dBc			-154dBc			
Max Input Power	2*50W						

<b>Mechanical</b>	
Dimensions (L*W*H)	308*190*72mm
Casing	UV Resistant ABS
Connector	4.3-10 mini-DIN (F)
Cable	2*300mm Low Loss Plenum Rated RG-402 Equivalent
Weight	0.9Kg
Colour	RAL 9003 White

<b>Environmental</b>	
Flammability Rating	UL 94-V0
IP rating	IP54
Operating Temperature range	-40°C to +85°C
Storage Temperature range	-40°C to +90°C
Humidity	Non-condensing 65°C 95%RH

## 2.2 Cable Specifications



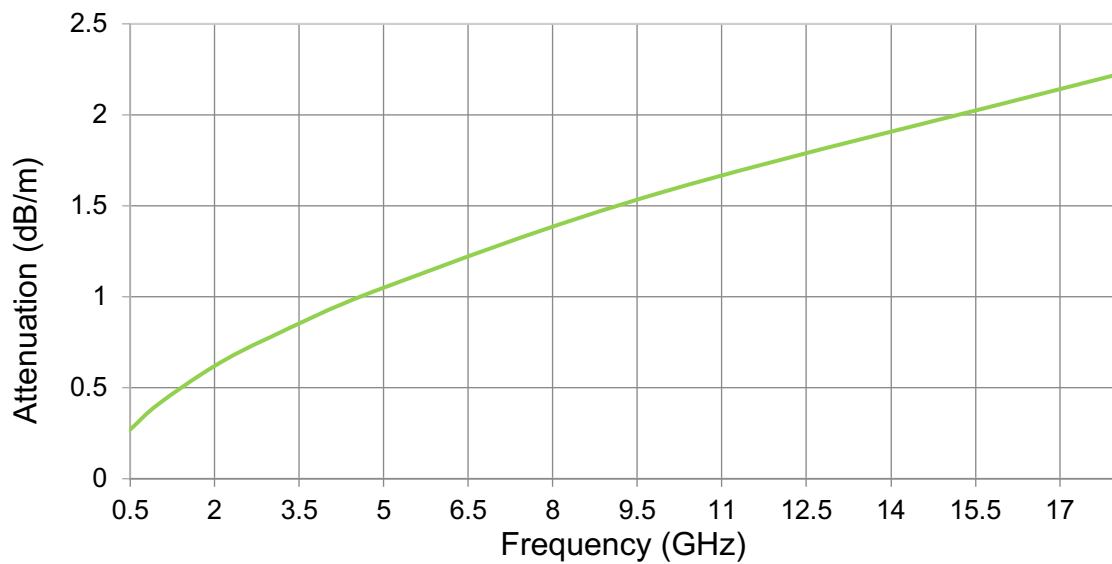
Part Designation	Material	Outer Diameter (mm)
Inner Conductor	Silver Plated Copper	0.94±0.01
Dielectric	PTFE	2.98±0.05
Outer Conductor	Tin Plated Copper Wire (16*6*0.12)	3.55±0.05
Jacket	FEP Blue	4.10±0.05

Electrical Characteristics		
Performance Property		Spec.
Capacitance (pF/m)		98
Impedance(Ohm)		50±2
Cutoff Frquency (GHz)		34
Time delay (ns/m)		4.7
Max Operating Voltage (KVrms)		3000

Mechanical Specifications		
Performance Properties		Spec.
Min. bending radius static, single(mm)		8
Weight (kg/km)		48

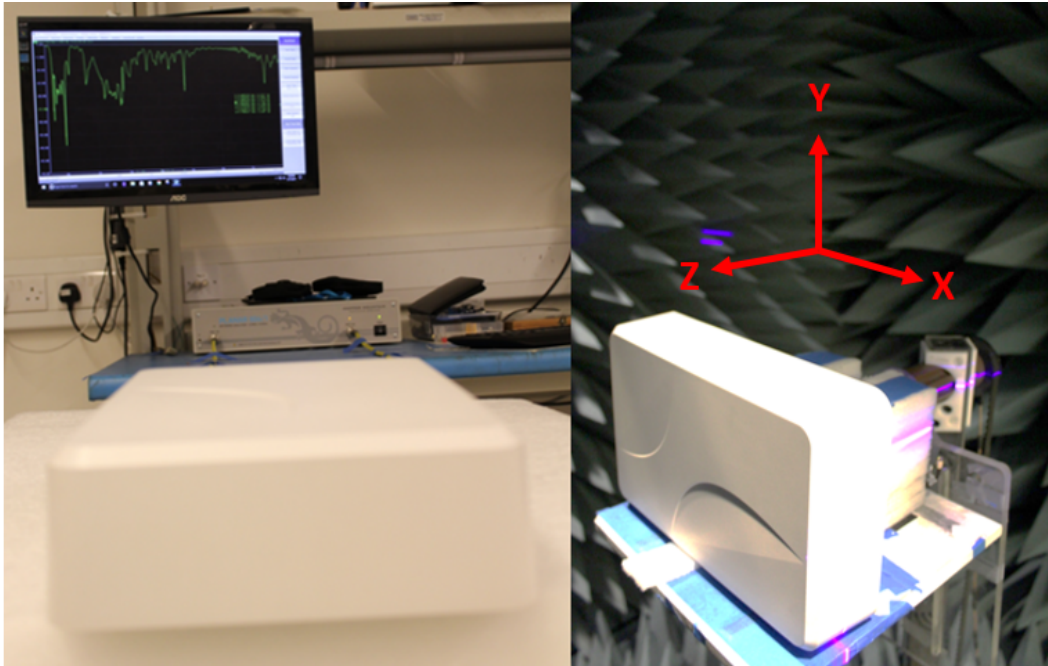
Environmental Specifications		
Performance Properties		Spec.
Operating Temperature (°C)		-65~150

Attenuation @ 20 °C	
Frequency (GHz)	Attenuation (dB/m)
0.5	0.27
1	0.41
2	0.62
3	0.78
5	1.05
10	1.58
18	2.22



**Figure 1** Attenuation vs. Frequency

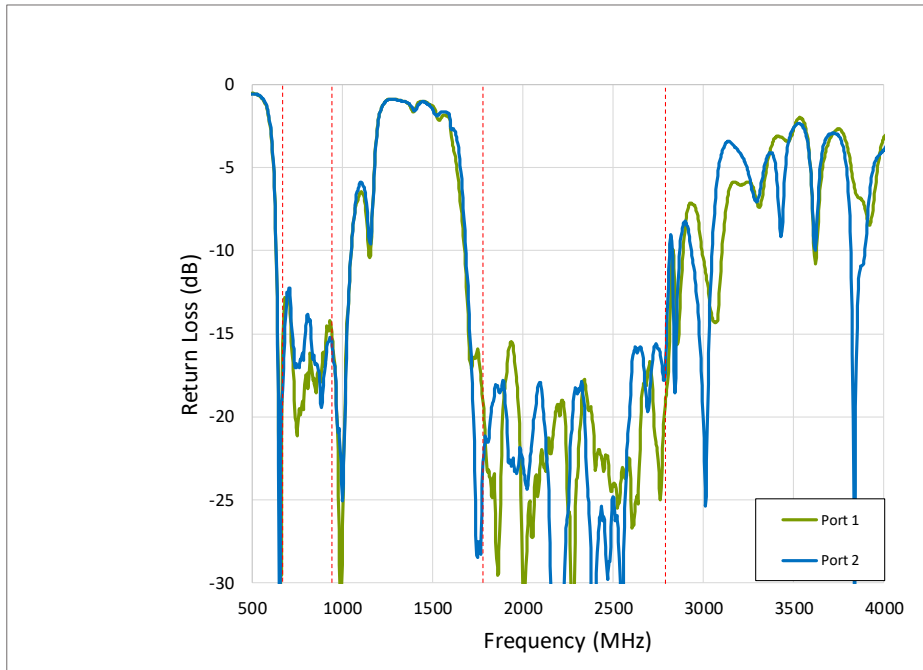
### 3. Test Setup



**Figure 2.** VNA test setup (left) and anechoic chamber test setup (right)

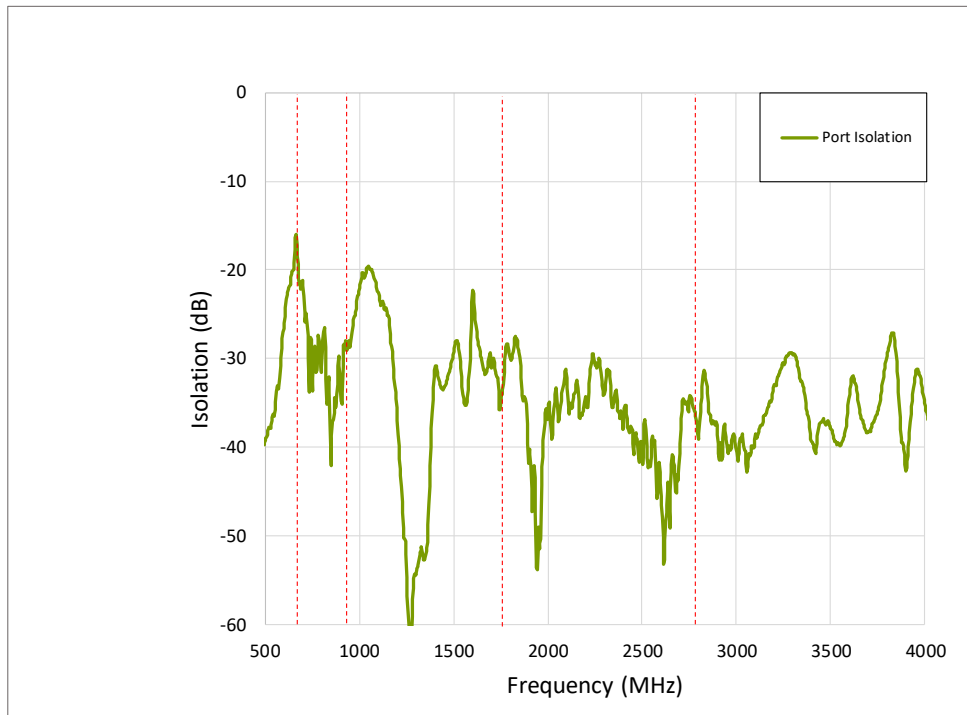
## 4. Antenna Performance

### 4.1. Return Loss S11 (dB)



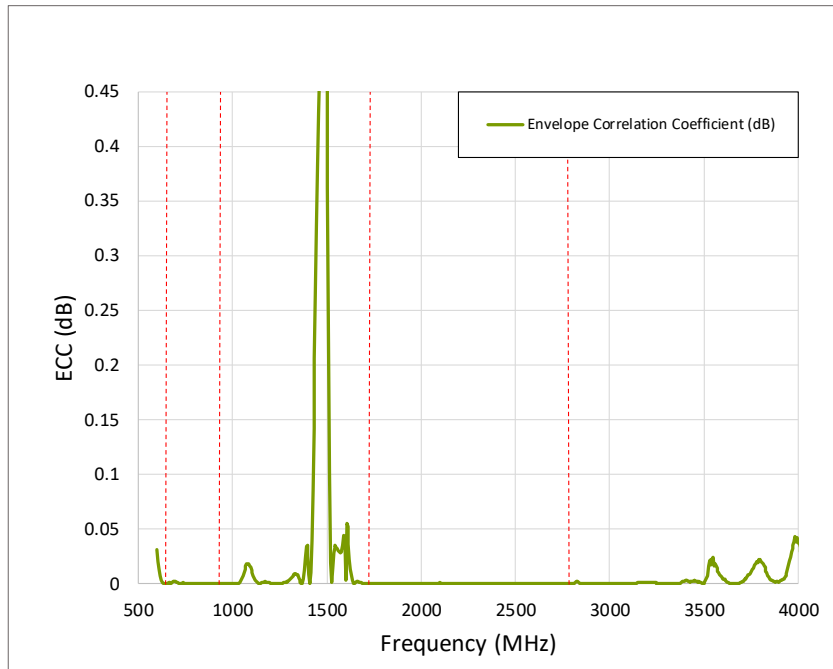
**Figure 3.** Return Loss (dB) S11

### 4.2 Isolation S21(dB)



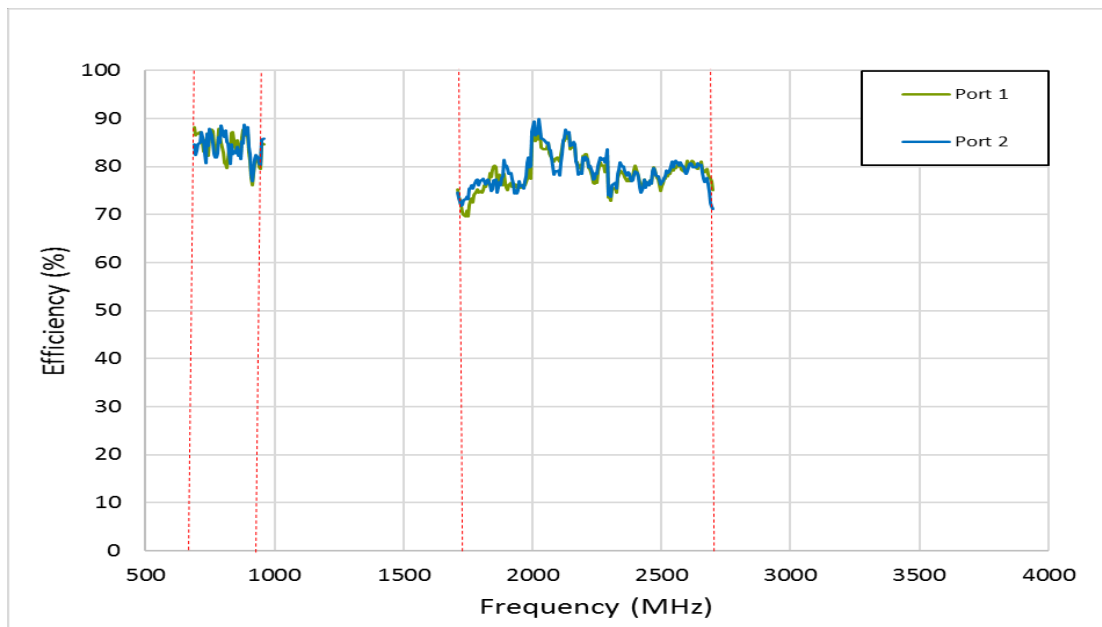
**Figure 4.** Isolation (dB) S21

### 4.3 Envelope Correlation Coefficient



**Figure 5.** Envelope Correlation Coefficient (ECC)

### 4.4 Efficiency (%)



**Figure 6.** Efficiency (%)

### 4.5 Peak Gain (dBi)

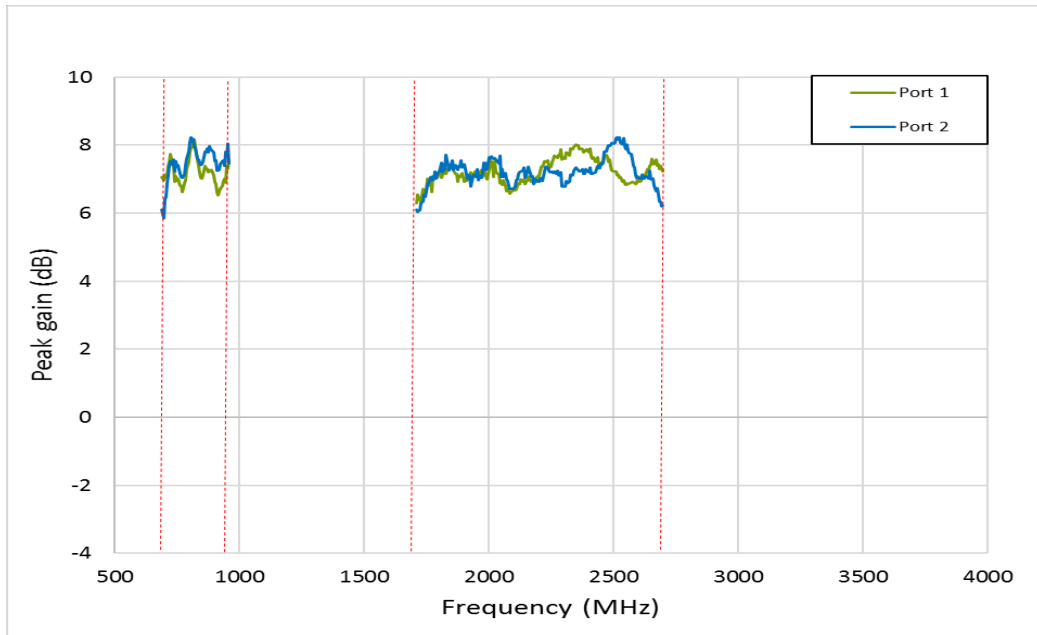


Figure 7. Peak gain (dBi)

### 4.6 Average Gain (dB)

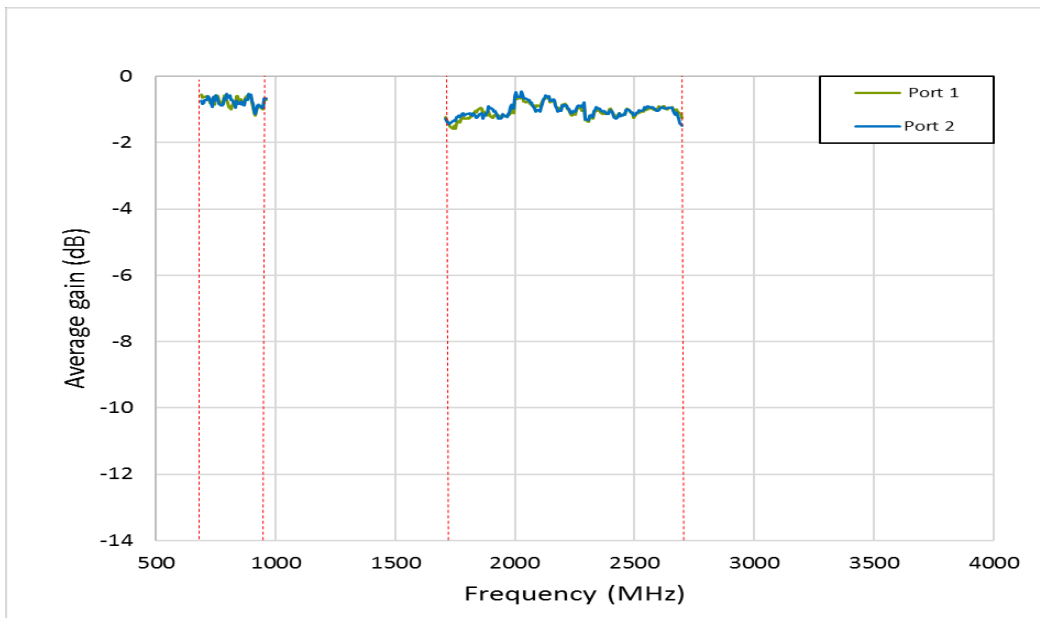
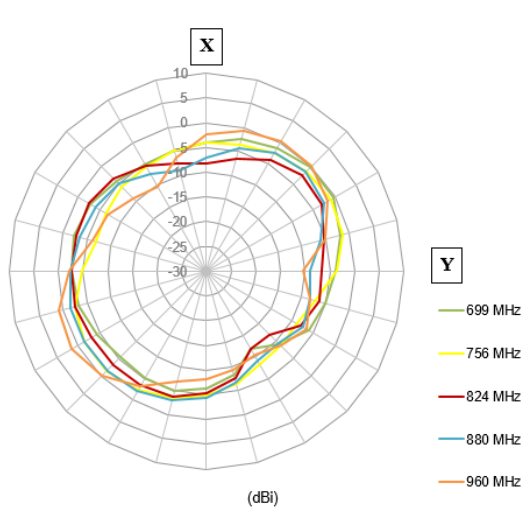


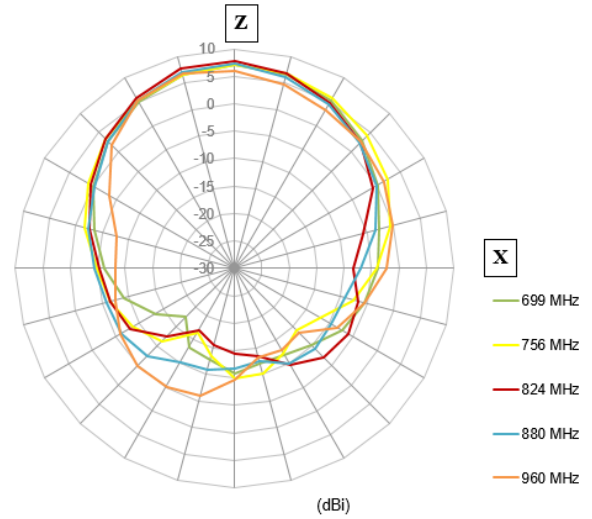
Figure 8. Average gain (dB)

## 5. 2D Radiation Patterns

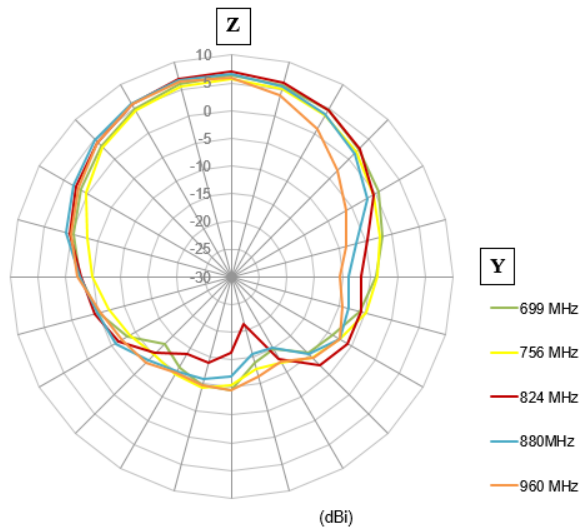
### 5.1 2D Radiation Patterns (Freq. range: 698 to 960MHz), Port 1



**Figure 9.** X-Y polar plot on target bands



**Figure 10.** Z-X polar plot on target bands



**Figure 11.** Z-Y polar plot on target bands

## 5.2 2D Radiation Patterns (Freq. range: 1710 to 2690MHz), Port 1

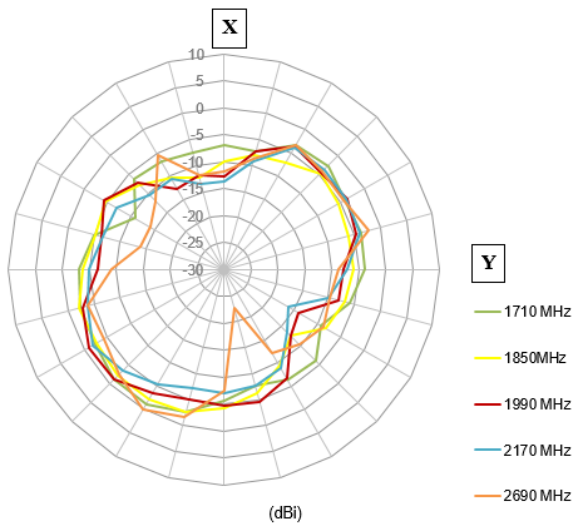


Figure 12. X-Y polar plots on target bands

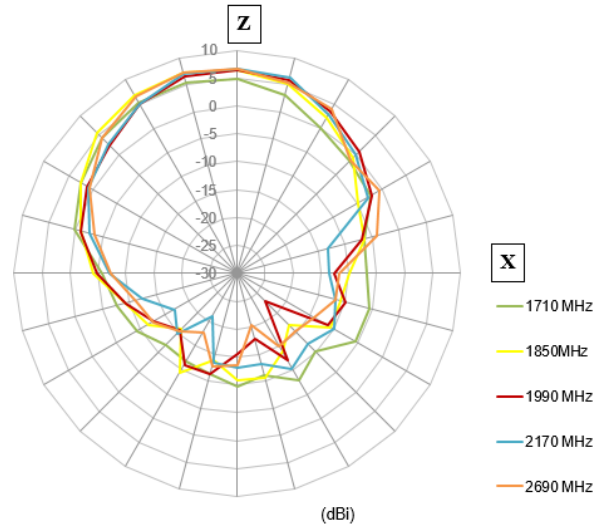


Figure 13. Z-X polar plots on target bands

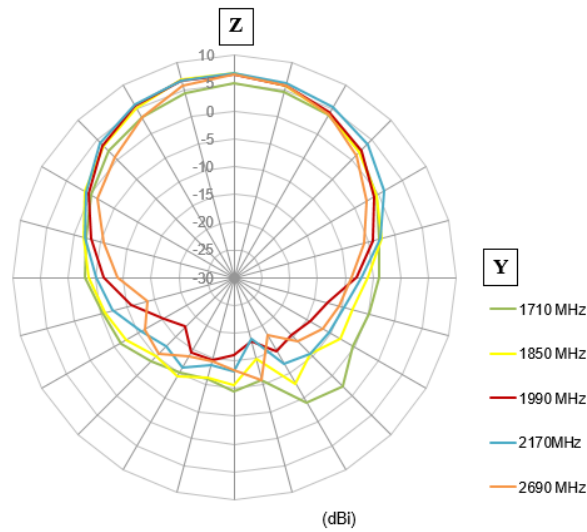
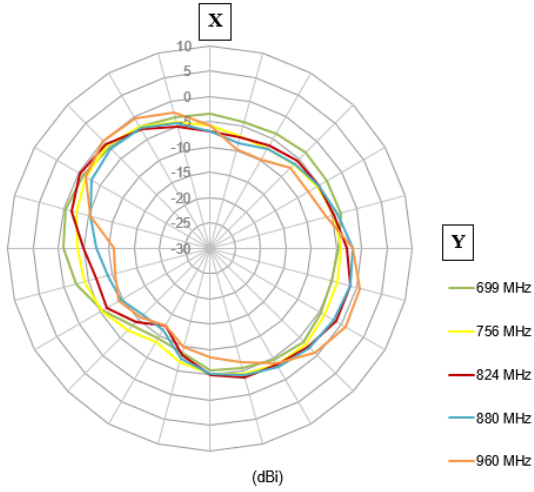
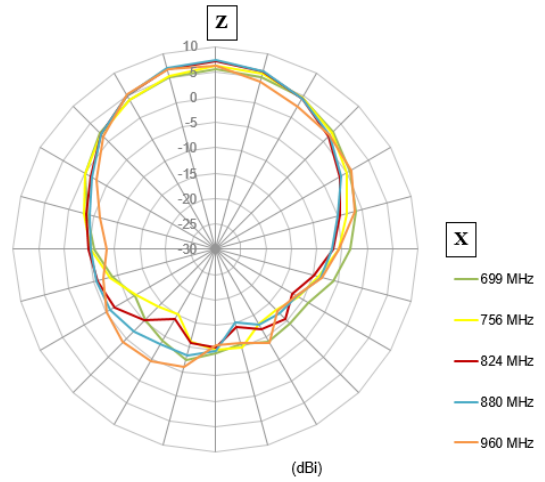


Figure 14. Z-Y polar plots on target bands

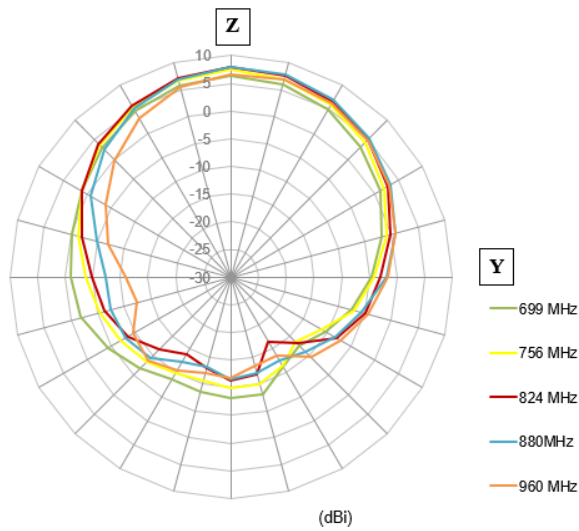
### 5.3 2D Radiation Patterns (Freq. range: 698 to 960MHz), Port 2



**Figure 15.** X-Y polar plots on target bands

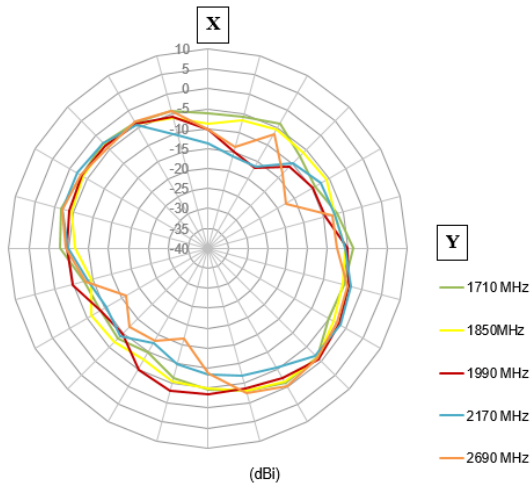


**Figure 16.** Z-X polar plots on target

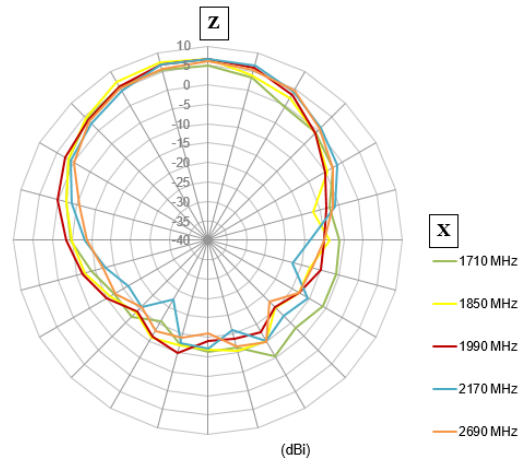


**Figure 17.** Z-Y polar plot on target bands

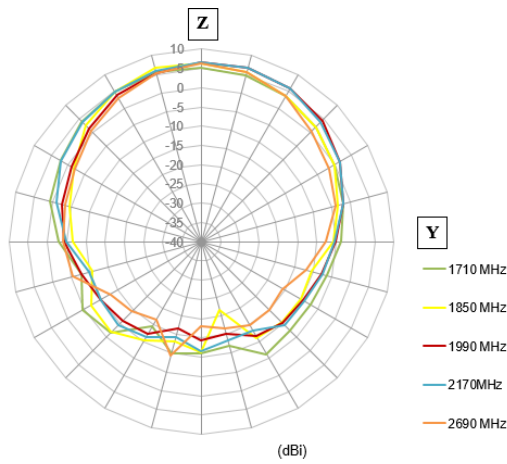
## 5.4 2D Radiation Patterns (Freq. range: 1710 to 2690MHz), Port.2



**Figure 18.** X-Y polar plot on target bands



**Figure 19.** Z-X polar plot on target bands

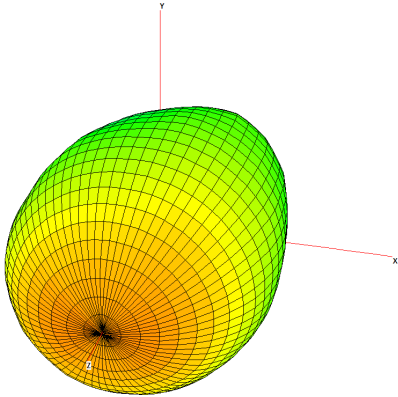


**Figure 20.** Z-Y polar plot on target bands

# 6. 3D Radiation Patterns

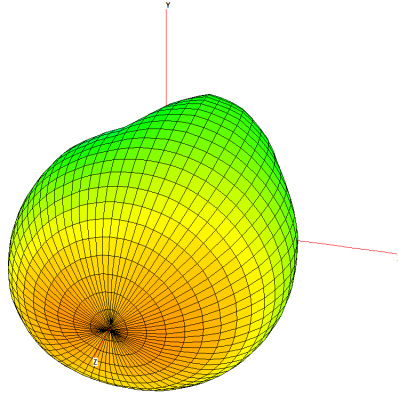
## 6.1 3D Radiation Patterns Port 1

Azimuth = 0.0  
Elevation = -30.0  
Roll = -15.0



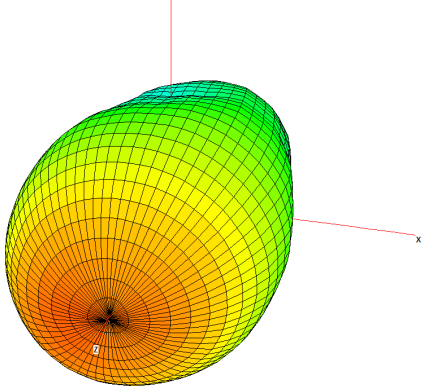
699MHz

Azimuth = 0.0  
Elevation = -30.0  
Roll = -15.0



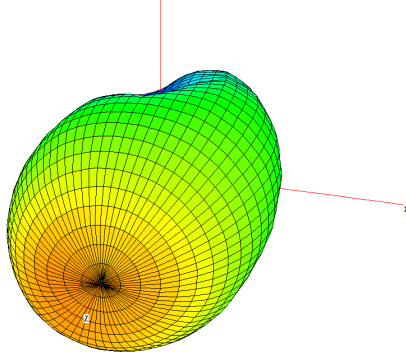
756MHz

Azimuth = 0.0  
Elevation = -30.0  
Roll = -15.0



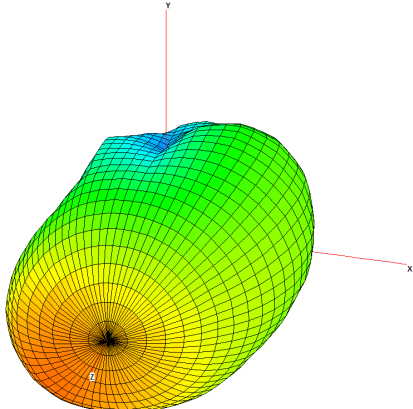
824MHz

Azimuth = 0.0  
Elevation = -30.0  
Roll = -15.0

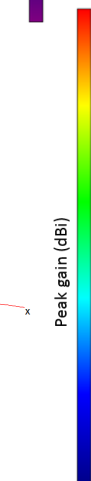
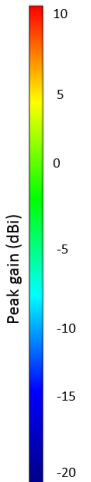
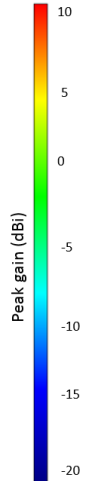
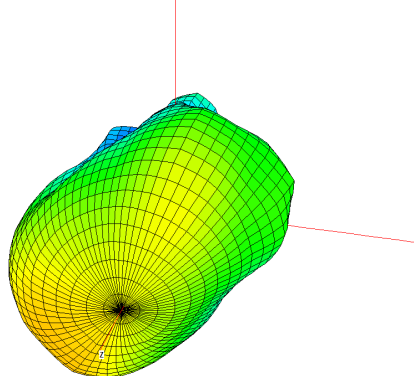


880MHz

Azimuth = 0.0  
Elevation = -30.0  
Roll = -15.0

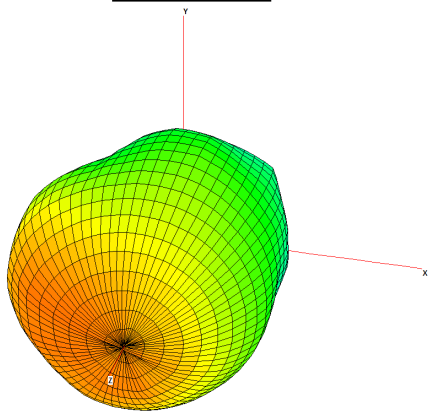


Azimuth = 0.0  
Elevation = -30.0  
Roll = -15.0



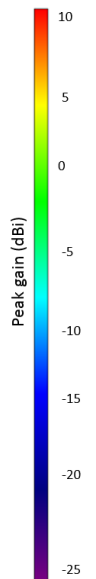
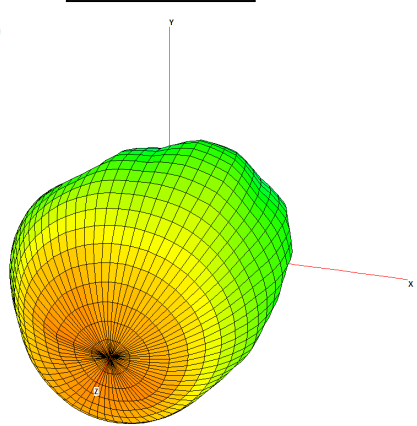
Azimuth = 0.0  
Elevation = -30.0  
Roll = -15.0

960MHz



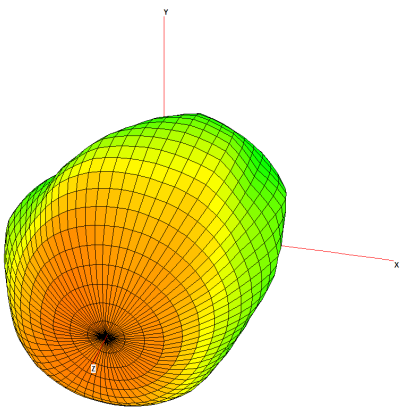
Azimuth = 0.0  
Elevation = -30.0  
Roll = -15.0

1710MHz



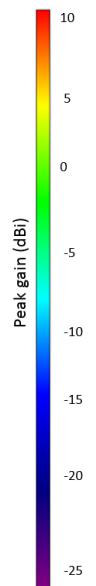
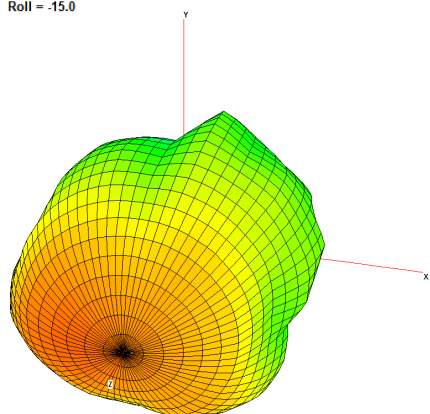
Azimuth = 0.0  
Elevation = -30.0  
Roll = -15.0

1850MHz



Azimuth = 0.0  
Elevation = -30.0  
Roll = -15.0

1990MHz

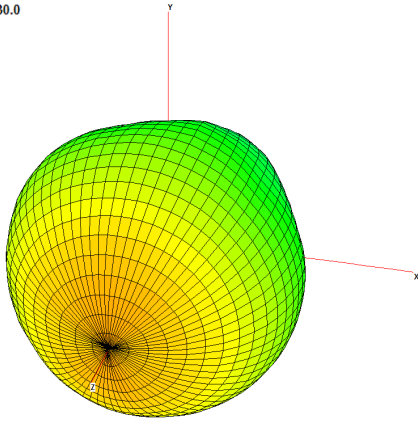


2170MHz

2690MHz

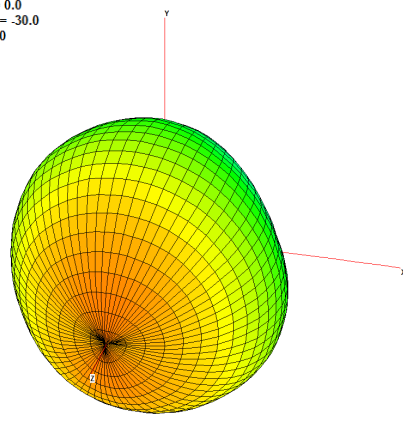
## 6.2 3D Radiation Patterns Port 2

Azimuth = 0.0  
Elevation = -30.0  
Roll = -15.0

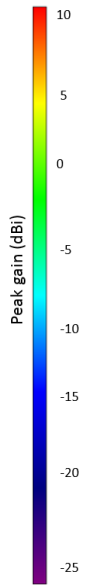


699MHz

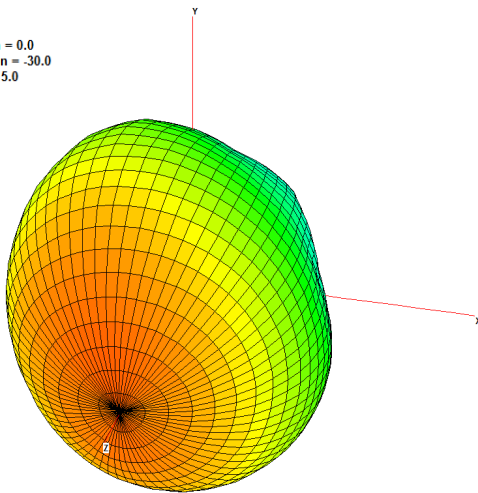
Azimuth = 0.0  
Elevation = -30.0  
Roll = -15.0



756MHz

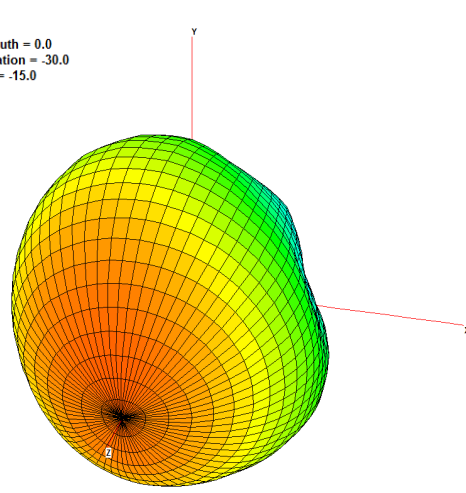


Azimuth = 0.0  
Elevation = -30.0  
Roll = -15.0

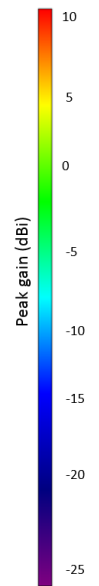


824MHz

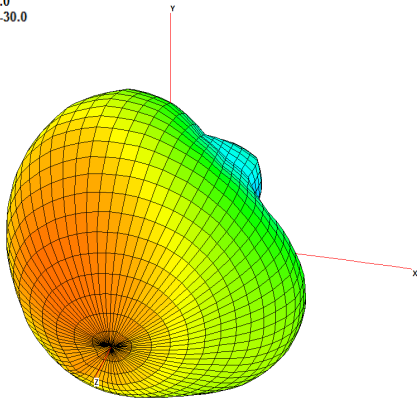
Azimuth = 0.0  
Elevation = -30.0  
Roll = -15.0



880MHz

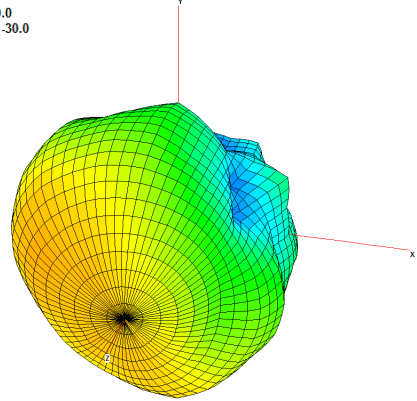


Azimuth = 0.0  
Elevation = -30.0  
Roll = -15.0

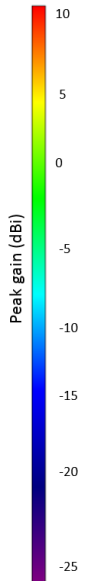


960MHz

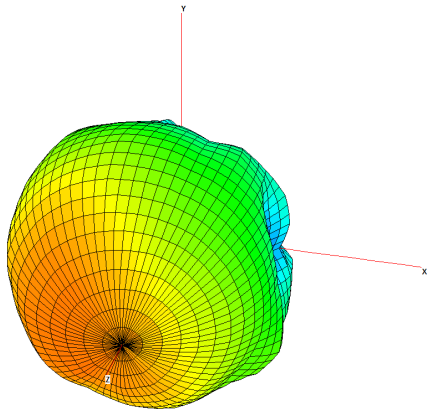
Azimuth = 0.0  
Elevation = -30.0  
Roll = -15.0



1710MHz

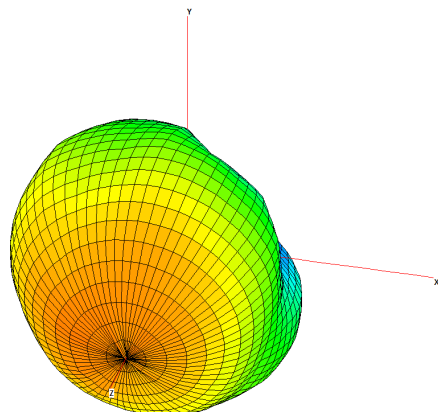


Azimuth = 0.0  
Elevation = -30.0  
Roll = -15.0

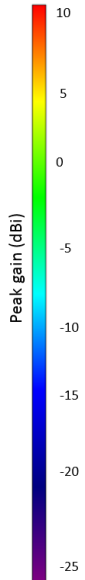


1850MHz

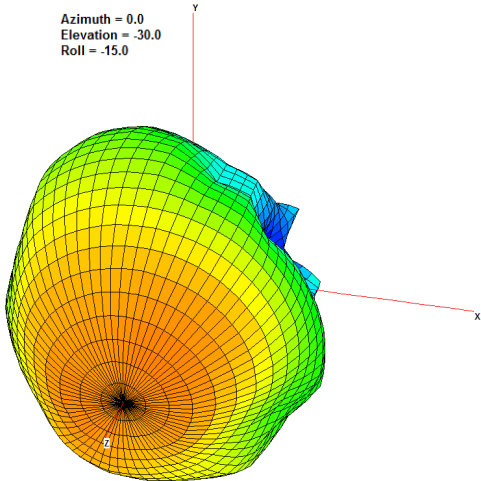
Azimuth = 0.0  
Elevation = -30.0  
Roll = -15.0



1990MHz

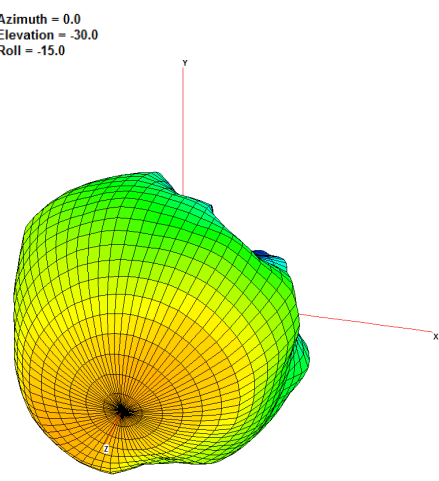


Azimuth = 0.0  
Elevation = -30.0  
Roll = -15.0

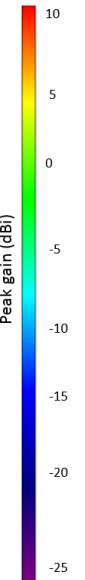


2170MHz

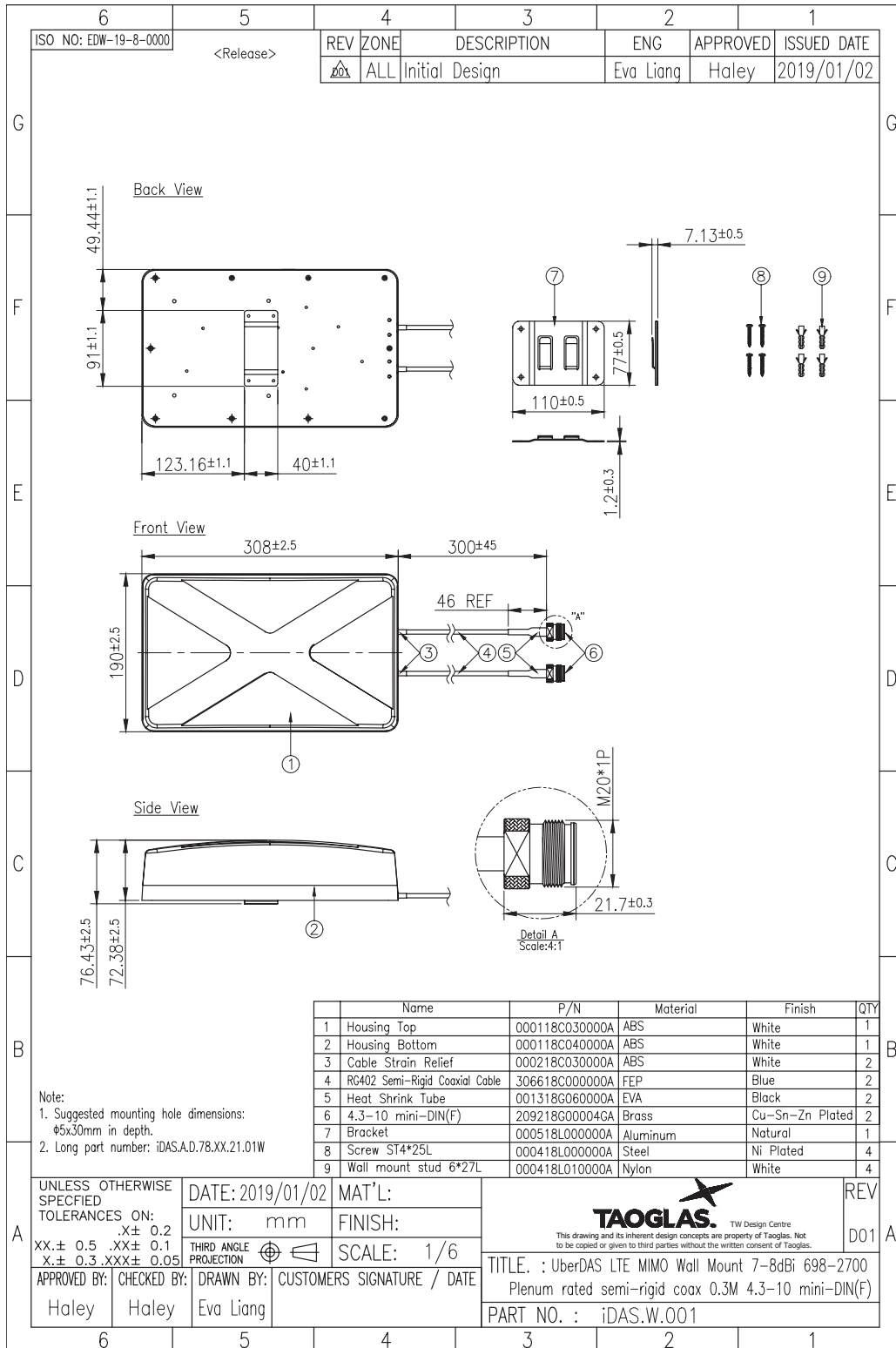
Azimuth = 0.0  
Elevation = -30.0  
Roll = -15.0



2690MHz

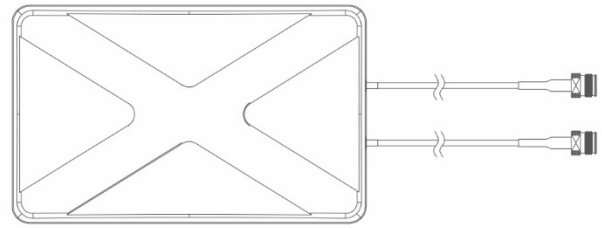


## 7. Mechanical Drawing (Unit: mm)

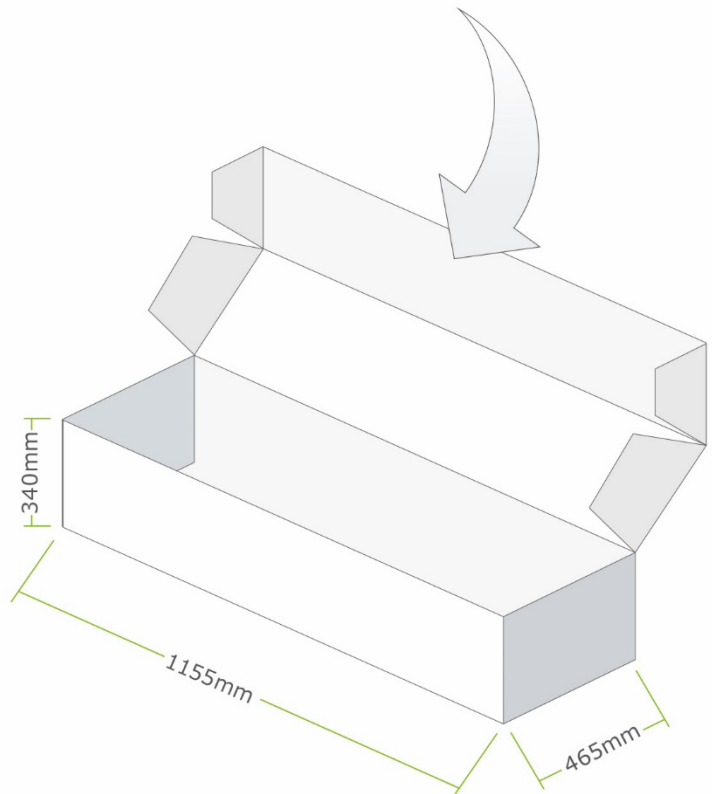


## 8. Packaging

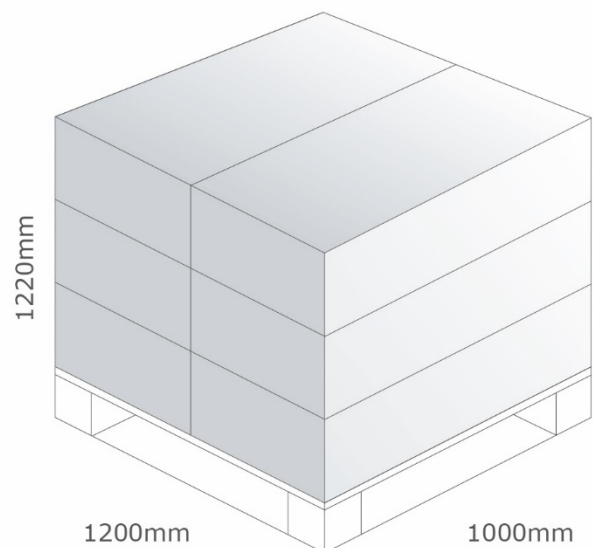
1pcs iDAS.W.001 per Box  
 Dimensions - 455\*320\*110mm  
 Weight - 1.5Kg



10pcs iDAS.W.001 per Carton  
 Dimensions - 1155\*465\*340mm  
 Weight - 17Kg



Pallet Dimensions:  
 1200mm\*1000mm\*1220mm  
 6 Cartons per Pallet  
 2 Cartons per Layer, 3 Layers



Taoglas makes no warranties based on the accuracy or completeness of the contents of this document and reserves the right to make changes to specifications and product descriptions at any time without notice. Taoglas reserves all rights to this document and the information contained herein.

Reproduction, use or disclosure to third parties without express permission is strictly prohibited.

Copyright © 2012, Taoglas Ltd.