

Final datasheet

Duo Pack EDT2™ IGBT and emitter controlled diode in TO247PLUS package

Features

- $V_{CE} = 750\text{ V}$
- $I_C = 160\text{ A}$
- Suitable for 470 V V_{DC} systems and increased overvoltage margin for 400 V V_{DC} systems
- Very low V_{CEsat} (C-KE) = 1.22 V (typ.) at $I_{Cnom} = 160\text{ A}$, 25°C
- Up to 40% less System R_{th} due to reflow capability, increased power output
- 30% Less Turn On Energy loss compared to 3 pin devices due to Kelvin emitter
- Short circuit robust $t_{sc} = 3\text{ }\mu\text{s}$ at $V_{CE} = 470\text{ V}$, $V_{GE} = 15\text{ V}$
- Self limiting current under short circuit condition
- Positive thermal coefficient and very tight parameter distribution for easy paralleling
- Excellent current sharing in parallel operation
- Smooth switching characteristics
- Low gate charge Q_G
- Simple gate driver design
- Co-packed with fast soft recovery emitter controlled diode (Emcon3)
- Low EMI signature
- TO247PLUS package with high creepage distance 6.6 mm
- High reliability and operating lifetime, proven power cycling sec. robustness
- Wide Power pins (2 mm) for high current busbar
- Resistive weldable pins for direct busbar connections
- Lead-free plated pins and back

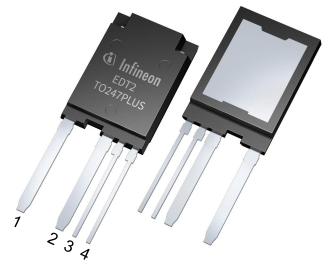

Potential applications

- xEV traction inverter
- DC-link discharge switch
- Automotive aux-drives

Product validation

- Qualified according to AEC-Q101 for automotive applications
- Qualified Reflow device 260°C according to JEDEC J-STD-020 MSL2

Description

Package pin definition:

- Pin C (1) & backside - collector
- Pin E (2) - emitter
- Pin K (3) - Kelvin emitter
- Pin G (4) - gate

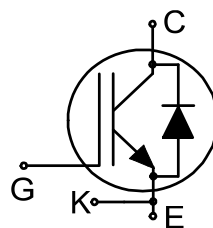

Type	Package	Marking
AIKYX160N75CP2	PG-TO247-4-PLUS-WT7	AKYX16FCP

Table of contents

	Description	1
	Features	1
	Potential applications	1
	Product validation	1
	Table of contents	2
1	Package	3
2	IGBT	3
3	Diode	5
4	Characteristics diagrams	7
5	Package outlines	16
6	Testing conditions	17
	Revision history	18
	Disclaimer	19

1 Package

Table 1 Characteristic values

Parameter	Symbol	Note or test condition	Values			Unit
			Min.	Typ.	Max.	
Internal emitter inductance	L_E	simulated starting from L2 at 1 MHz		3.7		nH
Collector-emitter loop inductance	L_{CE}	simulated starting from L2 at 1 MHz		6.2		nH
Main emitter pin resistance	R_E	Simulated starting from L2 at 10 kHz		0.37		mΩ
Storage temperature	T_{stg}		-55		150	°C
Soldering temperature	T_{sold}	reflow soldering (MSL2 according to JEDEC J-STD-020)			260	°C
Thermal resistance, junction-ambient	$R_{th(j-a)}$			40		K/W
IGBT thermal resistance, junction-case	$R_{th(j-c)}$			0.15	0.2 ¹⁾	K/W
Diode thermal resistance, junction-case	$R_{th(j-c)}$			0.28	0.36 ¹⁾	K/W

1) Defined by simulation, not subject to production test

2 IGBT

Table 2 Maximum rated values

Parameter	Symbol	Note or test condition	Values	Unit
Collector-emitter voltage	V_{CE}	$T_{vj} \geq 25\text{ °C}$	750	V
DC collector current, limited by T_{vjmax}	I_C	$T_c = 25\text{ °C}$	200	A
		$T_c = 100\text{ °C}$	160	
Pulsed collector current, t_p limited by T_{vjmax}	I_{Cpulse}		480	A
Turn-off safe operating area		$V_{CE} \leq 750\text{ V}, T_{vj} \leq 175\text{ °C}$	480	A
Gate-emitter voltage	V_{GE}		±20	V
Transient gate-emitter voltage	V_{GE}	$t_p = 10\text{ }\mu\text{s}, D < 0.01$	±30	V
Short-circuit withstand time ¹⁾	t_{SC}	$V_{CC} \leq 470\text{ V}, V_{GE} = -8/15\text{ V}$, Allowed number of short circuits < 1000, Time between short circuits $\geq 1.0\text{ s}, T_{vj} = 25\text{ °C}$	3	μs
Power dissipation	P_{tot}	$T_{vj} = 175\text{ °C}$		W
		$T_c = 25\text{ °C}$	750	
		$T_c = 100\text{ °C}$	375	

1) Measured with kelvin emitter for driving

Table 3 Characteristic values

Parameter	Symbol	Note or test condition		Values			Unit
				Min.	Typ.	Max.	
Collector-emitter saturation voltage	V_{CEsat}	$I_C = 160\text{ A}, V_{GE} = 15\text{ V}$	$T_{vj} = 25\text{ °C}$	1.2	1.37	1.55	V
			$T_{vj} = 175\text{ °C}$		1.6		
Collector-Kelvin emitter saturation voltage	V_{CEsat} (C-KE)	$I_C = 160\text{ A}, V_{GE} = 15\text{ V}$	$T_{vj} = 25\text{ °C}$		1.22		V
Gate-emitter threshold voltage	V_{GETh}	$I_C = 2.15\text{ mA}, V_{CE} = V_{GE}$		5.2	5.8	6.4	V
Zero gate-voltage collector current	I_{CES}	$V_{CE} = 750\text{ V}, V_{GE} = 0\text{ V}$	$T_{vj} = 25\text{ °C}$			200	μA
			$T_{vj} = 175\text{ °C}$		8		mA
Gate-emitter leakage current	I_{GES}	$V_{CE} = 0\text{ V}, V_{GE} = 20\text{ V}$				100	nA
Transconductance	g_{fs}	$I_C = 160\text{ A}, V_{CE} = 20\text{ V}$			117		S
Short-circuit collector current	I_{SC}	$V_{CC} \leq 470\text{ V}, V_{GE} = -8/15\text{ V}, t_{SC} \leq 3\text{ }\mu\text{s}$, Allowed number of short circuits < 1000, Time between short circuits $\geq 1.0\text{ s}$, $T_{vj} = 25\text{ °C}$			1500		A
Input capacitance	C_{ies}	$V_{CE} = 25\text{ V}, V_{GE} = 0\text{ V}, f = 100\text{ kHz}$			17280		pF
Output capacitance	C_{oes}	$V_{CE} = 25\text{ V}, V_{GE} = 0\text{ V}, f = 100\text{ kHz}$			443		pF
Reverse transfer capacitance	C_{res}	$V_{CE} = 25\text{ V}, V_{GE} = 0\text{ V}, f = 100\text{ kHz}$			79		pF
Gate charge	Q_G	$V_{CC} = 600\text{ V}, I_C = 160\text{ A}, V_{GE} = -8/15\text{ V}$			975		nC
Turn-on delay time	$t_{d(on)}$	$V_{CC} = 470\text{ V}, V_{GE} = -8/15\text{ V}, R_{G(on)} = 5\text{ }\Omega, L_\sigma = 20\text{ nH}, C_\sigma = 15\text{ pF}$	$T_{vj} = 25\text{ °C}, I_C = 160\text{ A}$		64		ns
			$T_{vj} = 175\text{ °C}, I_C = 160\text{ A}$		64		
Rise time (inductive load)	t_r	$V_{CC} = 470\text{ V}, V_{GE} = -8/15\text{ V}, R_{G(on)} = 5\text{ }\Omega, L_\sigma = 20\text{ nH}, C_\sigma = 15\text{ pF}$	$T_{vj} = 25\text{ °C}, I_C = 160\text{ A}$		35		ns
			$T_{vj} = 175\text{ °C}, I_C = 160\text{ A}$		43		
Turn-off delay time	$t_{d(off)}$	$V_{CC} = 470\text{ V}, V_{GE} = -8/15\text{ V}, R_{G(on)} = 5\text{ }\Omega, L_\sigma = 20\text{ nH}, C_\sigma = 15\text{ pF}$	$T_{vj} = 25\text{ °C}, I_C = 160\text{ A}$		234		ns
			$T_{vj} = 175\text{ °C}, I_C = 160\text{ A}$		315		
Fall time (inductive load)	t_f	$V_{CC} = 470\text{ V}, V_{GE} = -8/15\text{ V}, R_{G(on)} = 5\text{ }\Omega, L_\sigma = 20\text{ nH}, C_\sigma = 15\text{ pF}$	$T_{vj} = 25\text{ °C}, I_C = 160\text{ A}$		57		ns
			$T_{vj} = 175\text{ °C}, I_C = 160\text{ A}$		121		

(table continues...)

Table 3 (continued) Characteristic values

Parameter	Symbol	Note or test condition	Values			Unit
			Min.	Typ.	Max.	
Turn-on energy ¹⁾	E_{on}	$V_{CC} = 470\text{ V}, V_{GE} = -8/15\text{ V}, R_{G(on)} = 5\ \Omega, L_{\sigma} = 20\text{ nH}, C_{\sigma} = 15\text{ pF}$	$T_{vj} = 25\text{ }^{\circ}\text{C}, I_C = 160\text{ A}$		5.5	mJ
			$T_{vj} = 175\text{ }^{\circ}\text{C}, I_C = 160\text{ A}$		7.7	
Turn-off energy	E_{off}	$V_{CC} = 470\text{ V}, V_{GE} = -8/15\text{ V}, R_{G(on)} = 5\ \Omega, L_{\sigma} = 20\text{ nH}, C_{\sigma} = 15\text{ pF}$	$T_{vj} = 25\text{ }^{\circ}\text{C}, I_C = 160\text{ A}$		4.9	mJ
			$T_{vj} = 175\text{ }^{\circ}\text{C}, I_C = 160\text{ A}$		8.8	
Total switching energy	E_{ts}	$V_{CC} = 470\text{ V}, V_{GE} = -8/15\text{ V}, R_{G(on)} = 5\ \Omega, L_{\sigma} = 20\text{ nH}, C_{\sigma} = 15\text{ pF}$	$T_{vj} = 25\text{ }^{\circ}\text{C}, I_C = 160\text{ A}$		10.4	mJ
			$T_{vj} = 175\text{ }^{\circ}\text{C}, I_C = 160\text{ A}$		16.5	
Operating junction temperature	T_{vj}		-40		175	$^{\circ}\text{C}$

1) includes IGBT losses caused by the reverse recovery current

Note: Electrical Characteristic, at $T_{vj} = 25\text{ }^{\circ}\text{C}$, unless otherwise specified.

3 Diode

Table 4 Maximum rated values

Parameter	Symbol	Note or test condition	Values	Unit	
Repetitive peak reverse voltage	V_{RRM}	$T_{vj} \geq 25\text{ }^{\circ}\text{C}$	750	V	
Diode forward current, limited by T_{vjmax}	I_F		$T_C = 25\text{ }^{\circ}\text{C}$	200	A
			$T_C = 100\text{ }^{\circ}\text{C}$	160	
Diode pulsed current, t_p limited by T_{vjmax}	I_{Fpulse}		480	A	
Power dissipation	P_{tot}	$T_{vj} = 175\text{ }^{\circ}\text{C}$	$T_C = 25\text{ }^{\circ}\text{C}$	417	W
			$T_C = 100\text{ }^{\circ}\text{C}$	208	

Table 5 Characteristic values

Parameter	Symbol	Note or test condition	Values			Unit	
			Min.	Typ.	Max.		
Diode forward voltage	V_F	$I_F = 160\text{ A}$	$T_{vj} = 25\text{ }^{\circ}\text{C}$	1.6	1.8	2	V
			$T_{vj} = 175\text{ }^{\circ}\text{C}$		1.85		

(table continues...)

Table 5 (continued) Characteristic values

Parameter	Symbol	Note or test condition		Values			Unit
				Min.	Typ.	Max.	
Diode reverse recovery charge	Q_{rr}	$V_R = 470\text{ V}$	$T_{vj} = 25\text{ °C},$ $I_F = 160\text{ A},$ $-di_F/dt = 3996\text{ A}/\mu\text{s}$		5.5		μC
					14		
Diode peak reverse recovery current	I_{rrm}	$V_R = 470\text{ V}$	$T_{vj} = 25\text{ °C},$ $I_F = 160\text{ A},$ $-di_F/dt = 3996\text{ A}/\mu\text{s}$		68.7		A
					108.1		
Reverse recovery energy	E_{rec}	$V_R = 470\text{ V}, L_\sigma = 20\text{ nH},$ $C_\sigma = 15\text{ pF}$	$T_{vj} = 25\text{ °C},$ $I_F = 160\text{ A},$ $-di_F/dt = 3996\text{ A}/\mu\text{s}$		2.1		mJ
					4.9		
Operating junction temperature	T_{vj}			-40		175	$^{\circ}\text{C}$

Note: For optimum lifetime and reliability, Infineon recommends operating conditions that do not exceed 80% of the maximum ratings stated in this datasheet.

4 Characteristics diagrams

Power dissipation as a function of case temperature

$P_{tot} = f(T_c)$
 $T_{vj} \leq 175\text{ °C}$

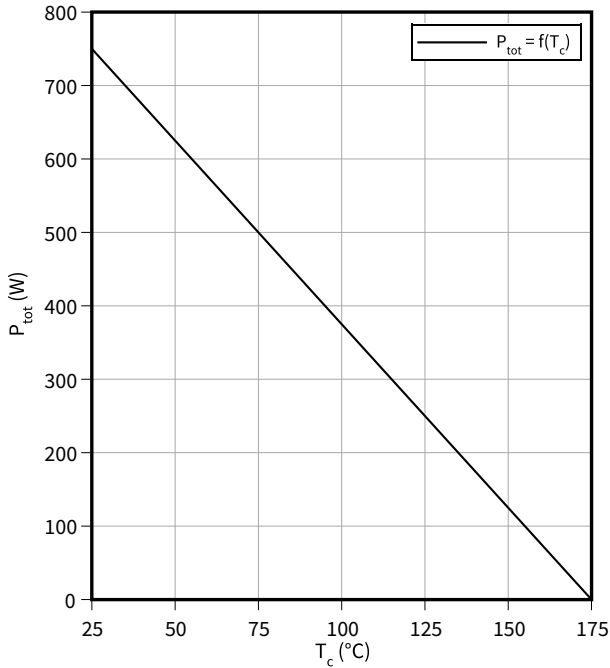

Typical output characteristic

$I_C = f(V_{CE(C-KE)})$
 $T_{vj} = 25\text{ °C}$

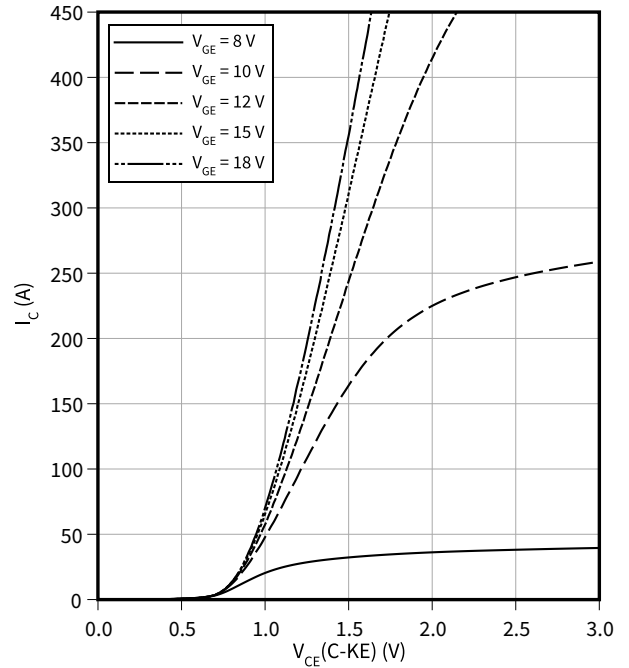

Typical output characteristic

$I_C = f(V_{CE(C-KE)})$
 $T_{vj} = 175\text{ °C}$

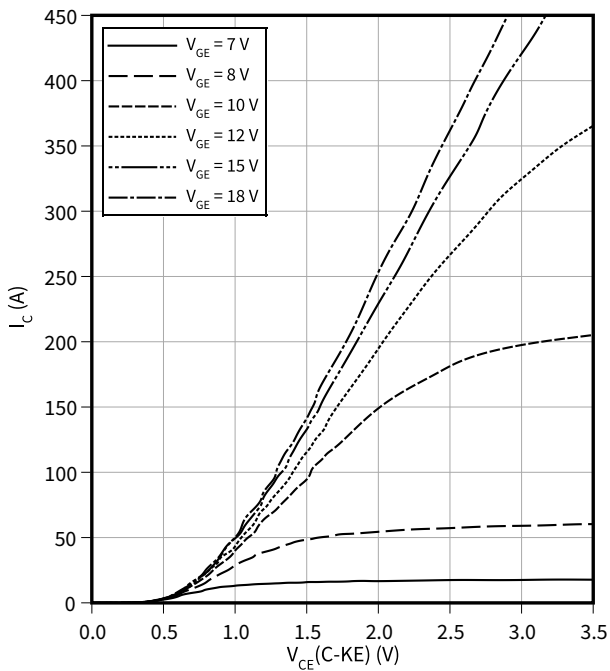

Typical transfer characteristic

$I_C = f(V_{GE})$
 $V_{CE} = 20\text{ V}$

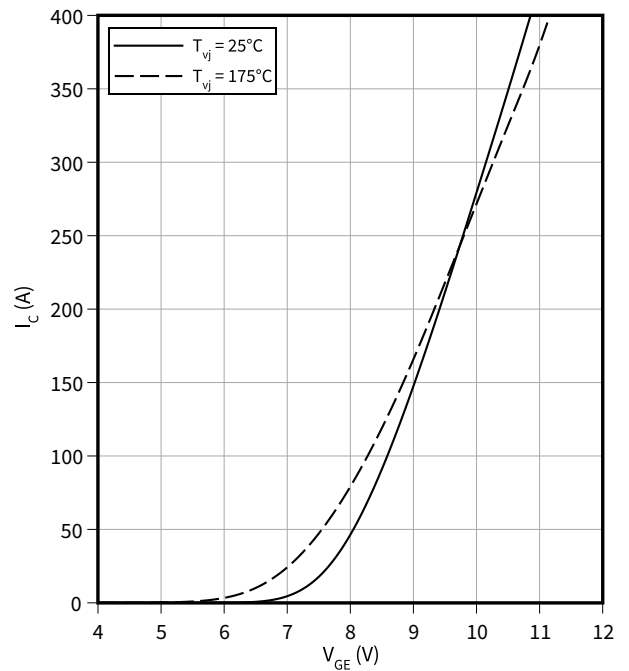

4 Characteristics diagrams

Typical collector-Kelvin emitter saturation voltage as a function of junction temperature

$V_{CEsat} (C-KE) = f(T_{vj})$

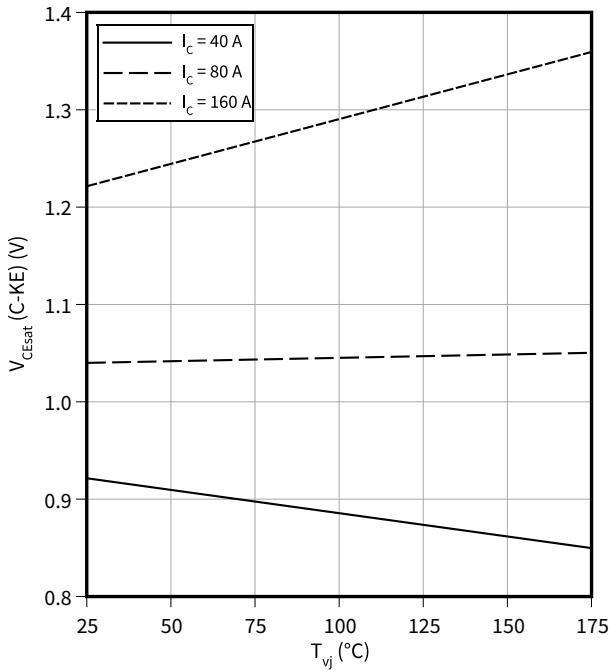

Gate-emitter threshold voltage as a function of junction temperature

$V_{GEth} = f(T_{vj})$
 $I_C = 2.15 \text{ mA}$

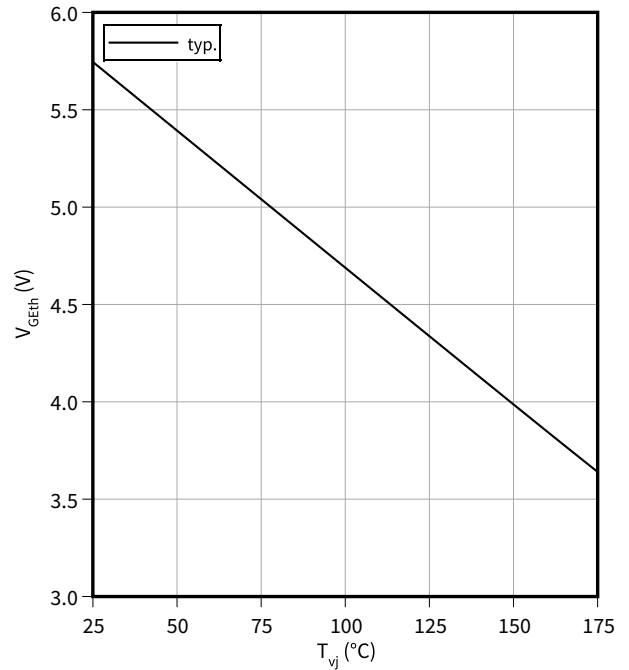

Typical switching times as a function of collector current

$t = f(I_C)$
 $V_{CC} = 470 \text{ V}, T_{vj} = 25 \text{ °C}, R_G = 5 \text{ } \Omega$

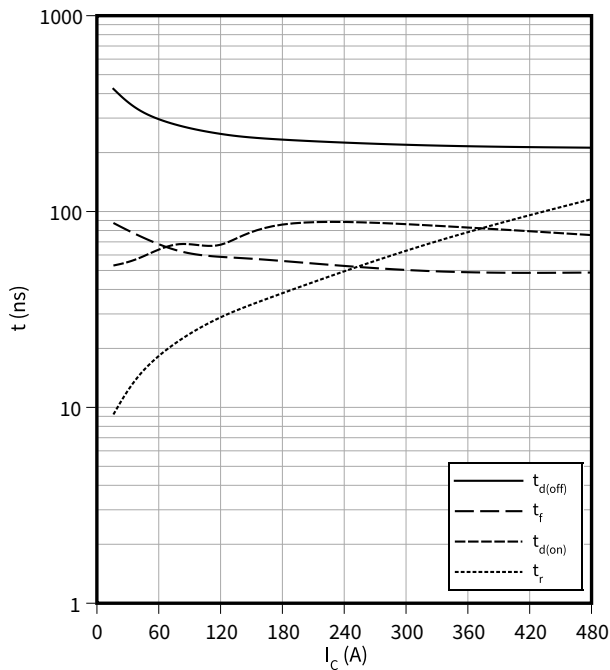

Typical switching times as a function of collector current

$t = f(I_C)$
 $V_{CC} = 470 \text{ V}, T_{vj} = 175 \text{ °C}, R_G = 5 \text{ } \Omega$

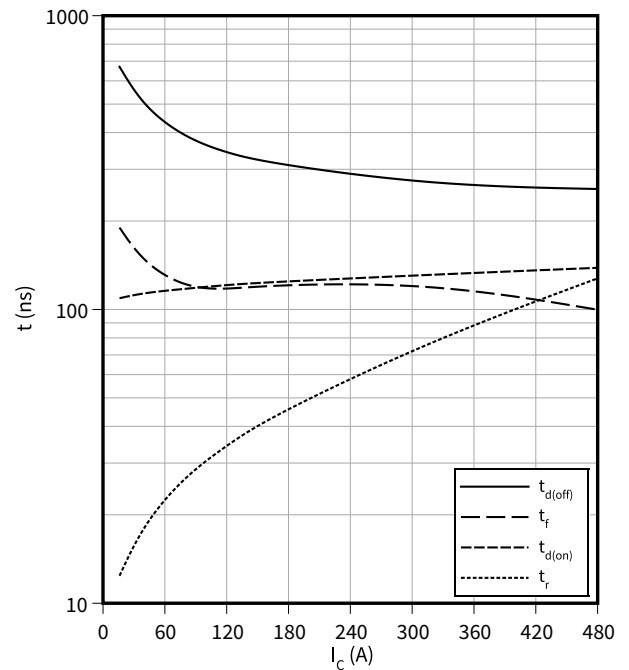

4 Characteristics diagrams

Typical switching times as a function of gate resistor

$t = f(R_G)$

$I_C = 160 \text{ A}, V_{CC} = 470 \text{ V}, T_{vj} = 25 \text{ °C}$

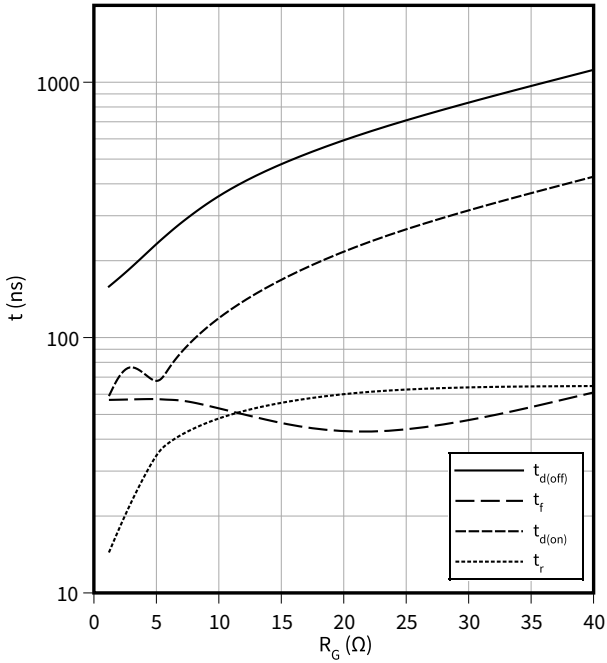

Typical switching times as a function of gate resistor

$t = f(R_G)$

$I_C = 160 \text{ A}, V_{CC} = 470 \text{ V}, T_{vj} = 175 \text{ °C}$

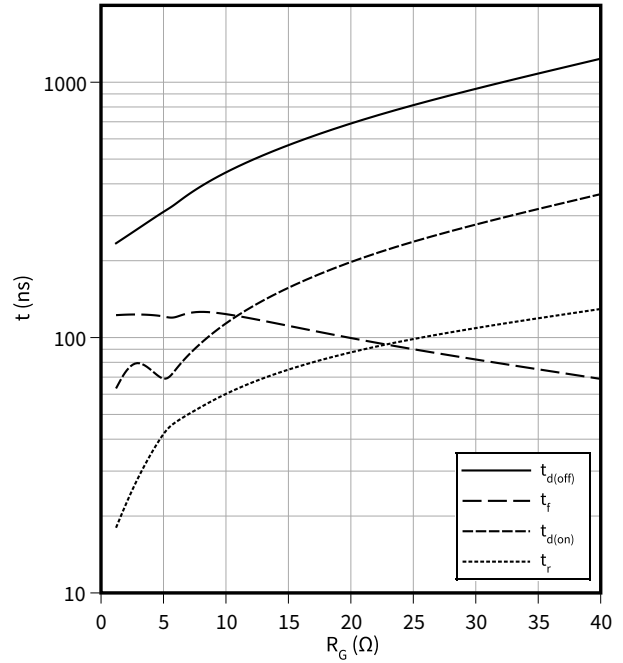

Typical switching times as a function of junction temperature

$t = f(T_{vj})$

$I_C = 160 \text{ A}, V_{CC} = 470 \text{ V}, R_G = 5 \text{ }\Omega$

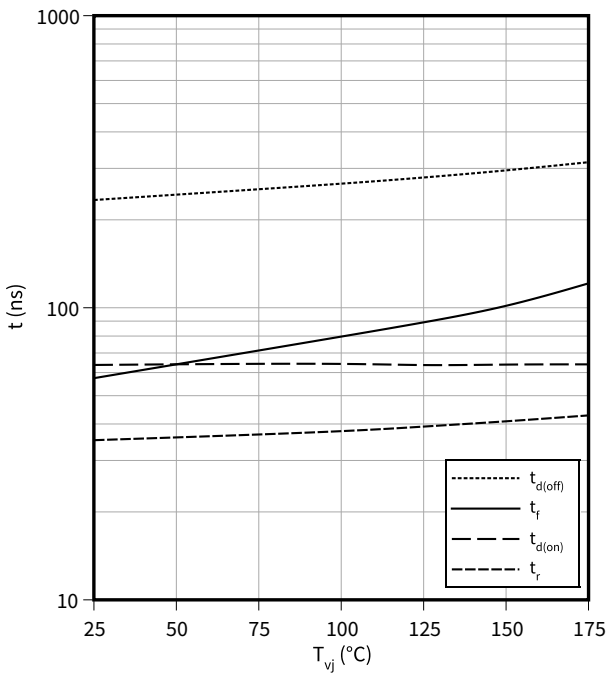

Typical switching energy losses as a function of collector current

$E = f(I_C)$

$V_{CC} = 470 \text{ V}, T_{vj} = 25 \text{ °C}, R_G = 5 \text{ }\Omega$

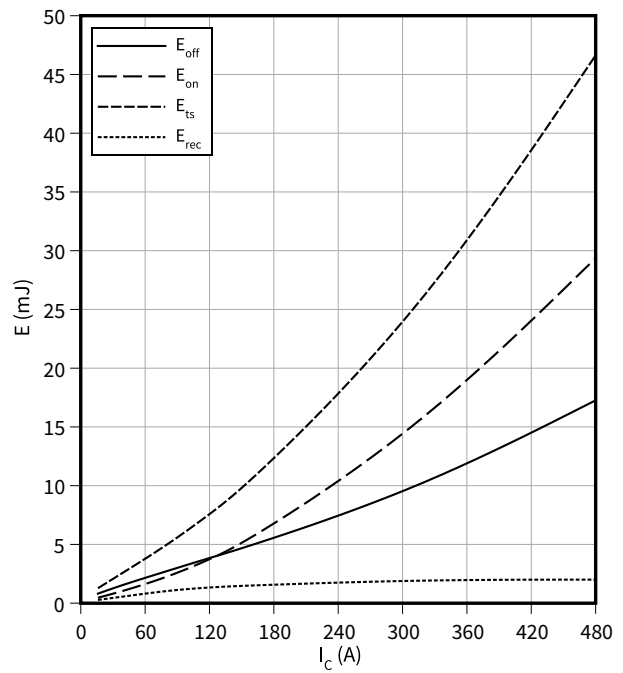

4 Characteristics diagrams

Typical switching energy losses as a function of collector current

$E = f(I_C)$

$V_{CC} = 470 \text{ V}, T_{vj} = 175 \text{ °C}, R_G = 5 \text{ } \Omega$

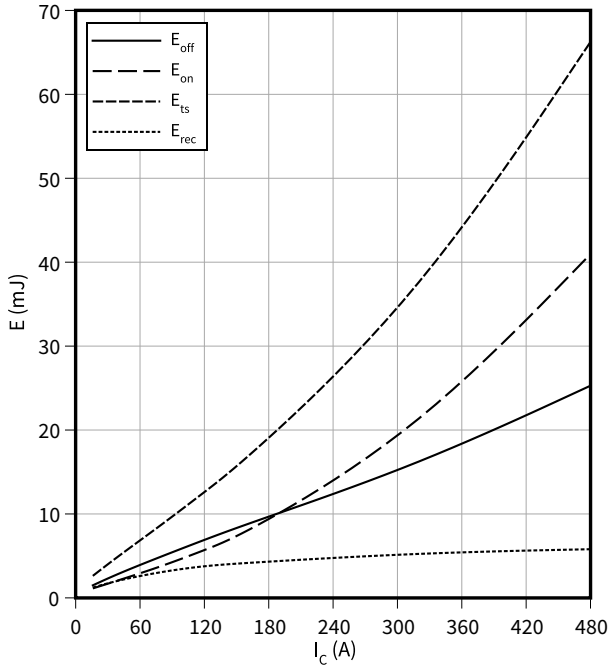

Typical switching energy losses as a function of gate resistor

$E = f(R_G)$

$I_C = 160 \text{ A}, V_{CC} = 470 \text{ V}, T_{vj} = 25 \text{ °C}$

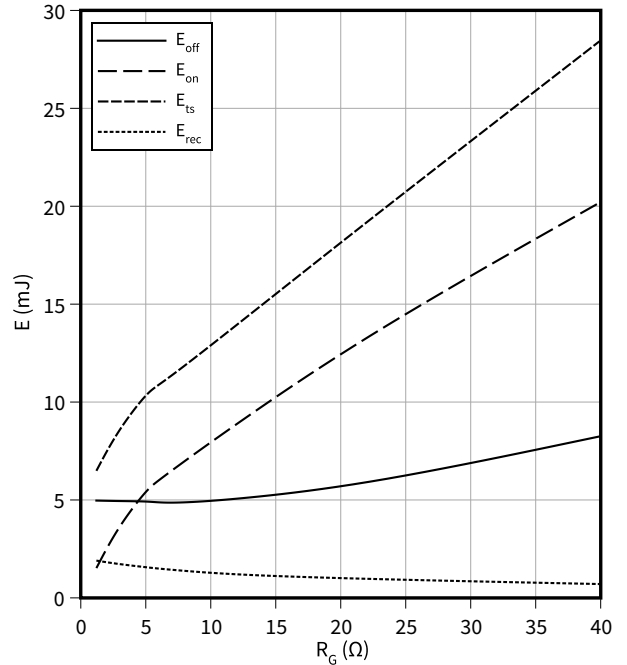

Typical switching energy losses as a function of gate resistor

$E = f(R_G)$

$I_C = 160 \text{ A}, V_{CC} = 470 \text{ V}, T_{vj} = 175 \text{ °C}$

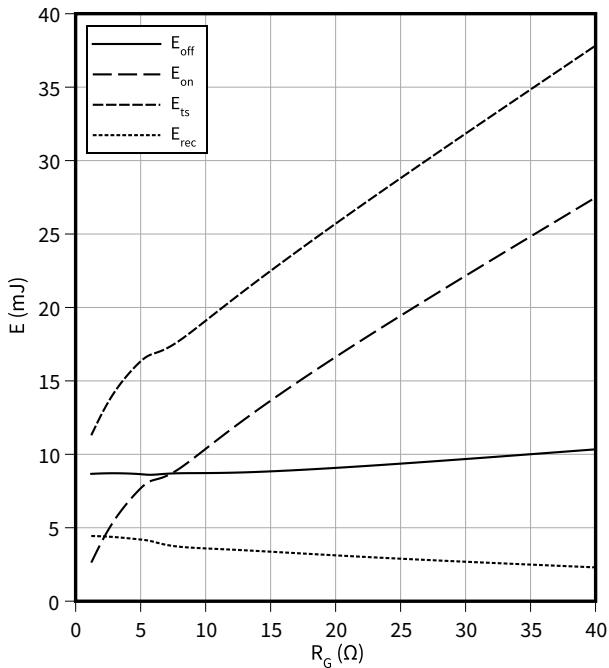

Typical switching energy losses as a function of junction temperature

$E = f(T_{vj})$

$I_C = 160 \text{ A}, V_{CC} = 470 \text{ V}, R_G = 5 \text{ } \Omega$

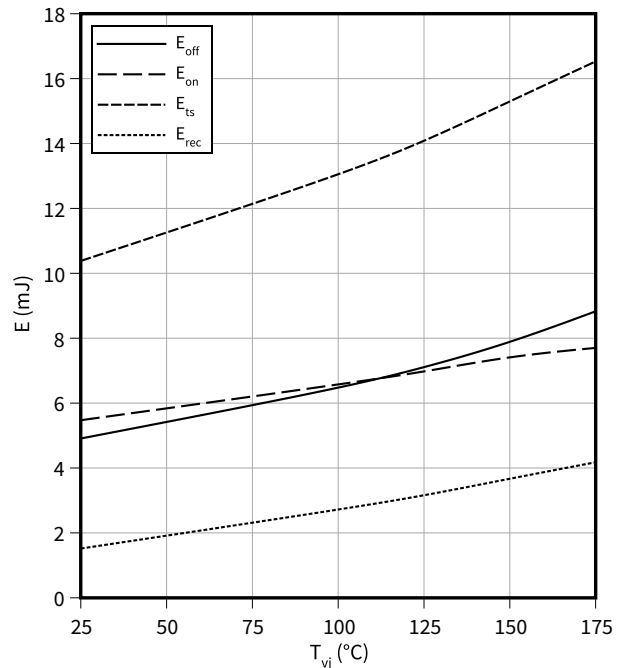

4 Characteristics diagrams

Typical switching energy losses as a function of collector emitter voltage

$E = f(V_{CE})$

$I_C = 160 \text{ A}, T_{vj} = 25 \text{ °C}, R_G = 5 \text{ } \Omega$

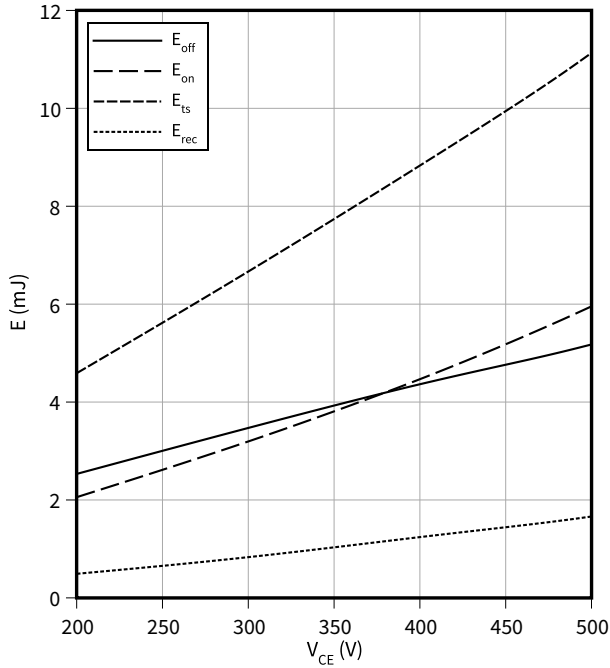

Typical switching energy losses as a function of collector emitter voltage

$E = f(V_{CE})$

$I_C = 160 \text{ A}, T_{vj} = 175 \text{ °C}, R_G = 5 \text{ } \Omega$

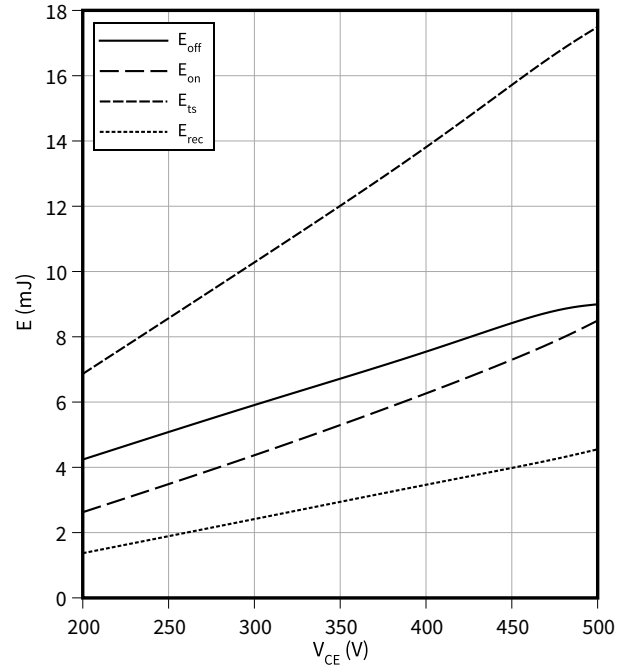

Typical gate charge

$V_{GE} = f(Q_G)$

$I_C = 160 \text{ A}$

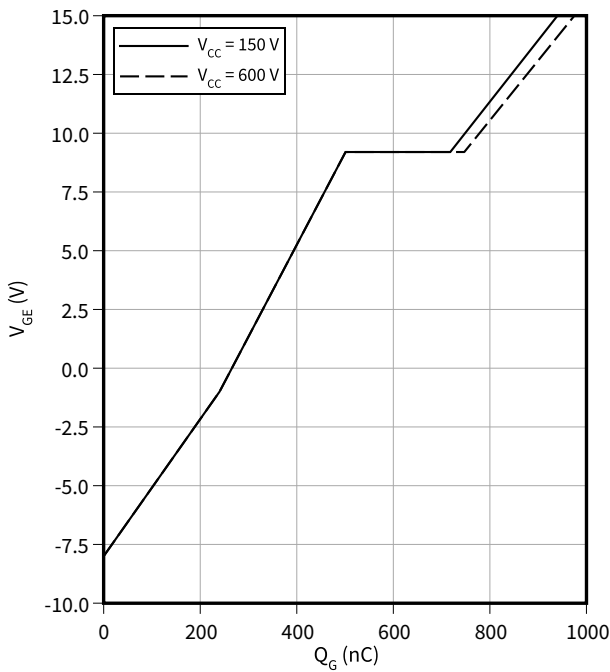

Typical capacitance as a function of collector-emitter voltage

$C = f(V_{CE})$

$f = 100 \text{ kHz}$

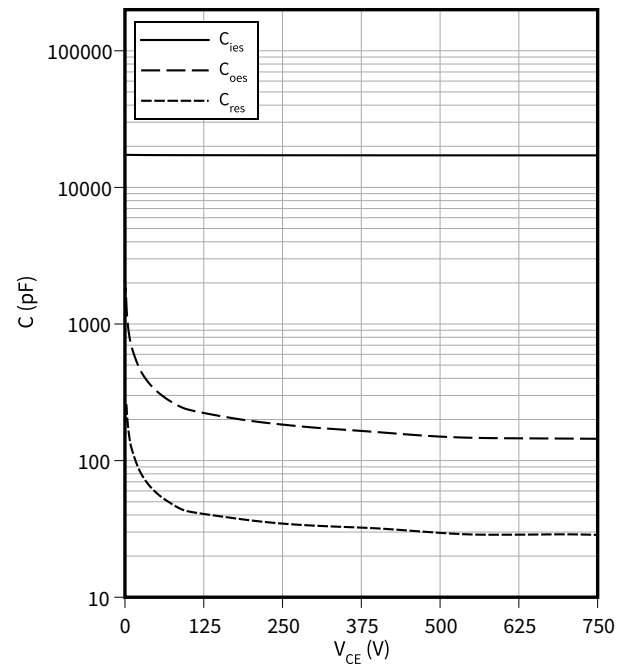

4 Characteristics diagrams

Typical short circuit collector current as a function of gate-emitter voltage

$I_{C(SC)} = f(V_{GE})$
 $T_{vj} = 175\text{ °C}, V_{CC} = 470\text{ V}$

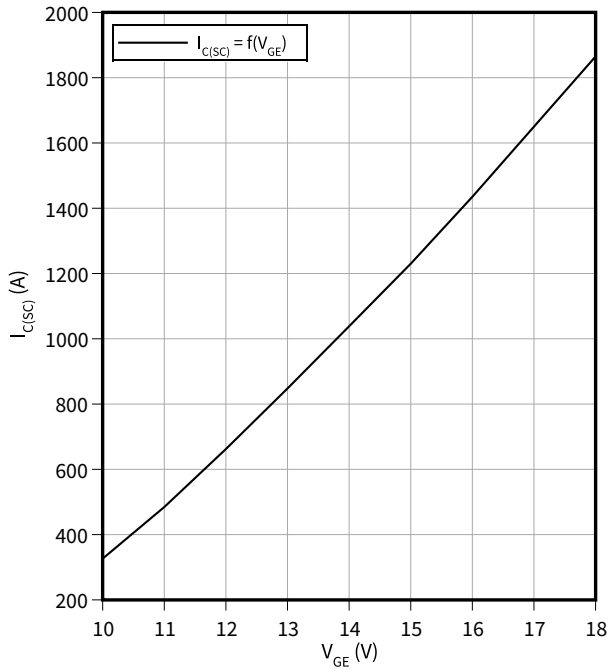

Short circuit withstand time as a function of gate-emitter voltage

$t_{SC} = f(V_{GE})$
 $T_{vj} = 175\text{ °C}, V_{CC} = 470\text{ V}$

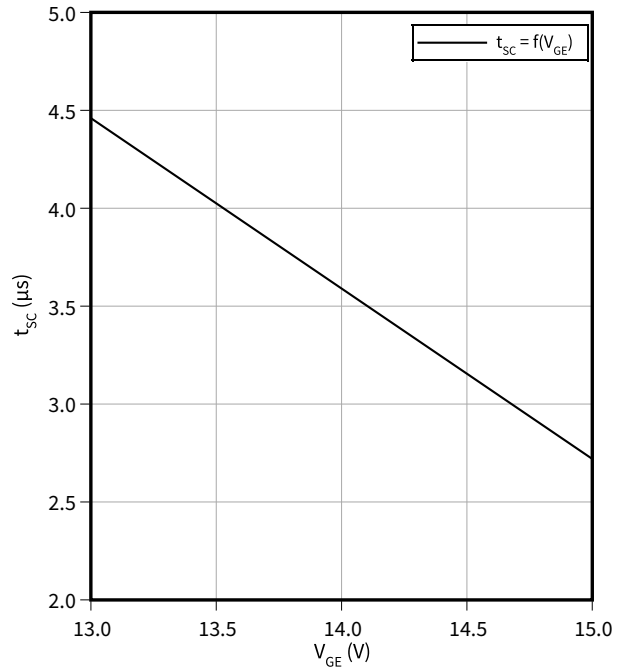

IGBT transient thermal impedance as a function of pulse width

$Z_{th(j-c)} = f(t_p)$
 $D = t_p/T$

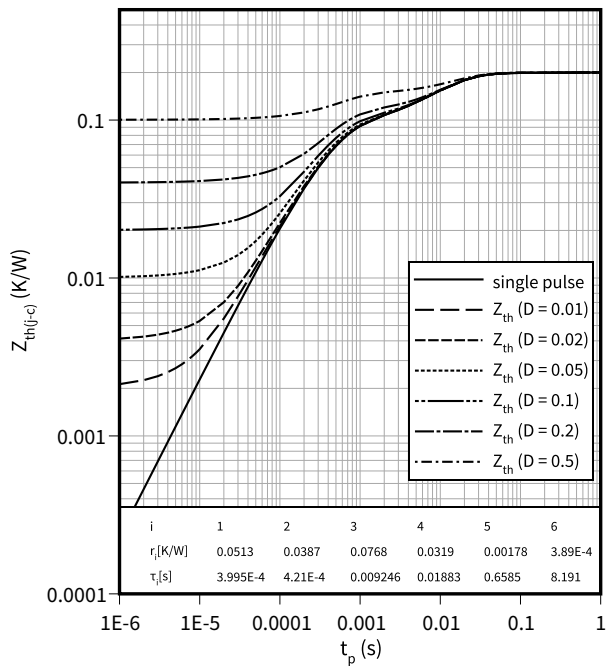

Power dissipation as a function of case temperature

$P_{tot} = f(T_c)$
 $T_{vj} \leq 175\text{ °C}$

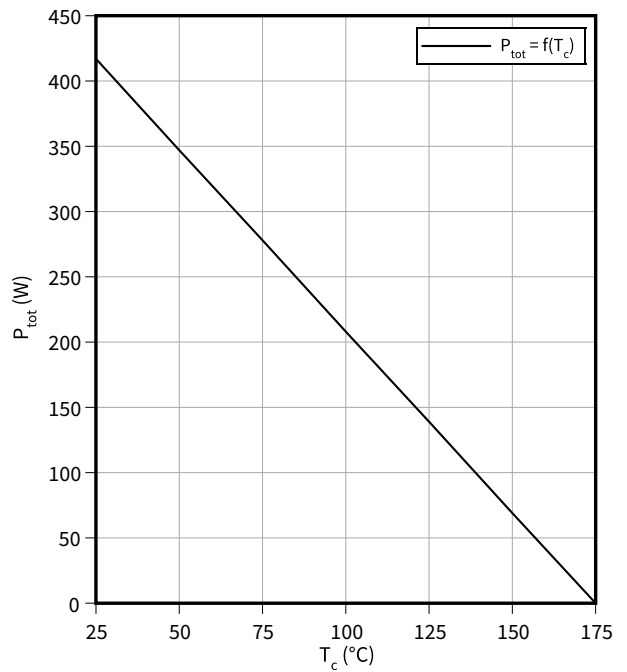

4 Characteristics diagrams

Diode transient thermal impedance as a function of pulse width

$$Z_{th(j-c)} = f(t_p)$$

$$D = t_p/T$$

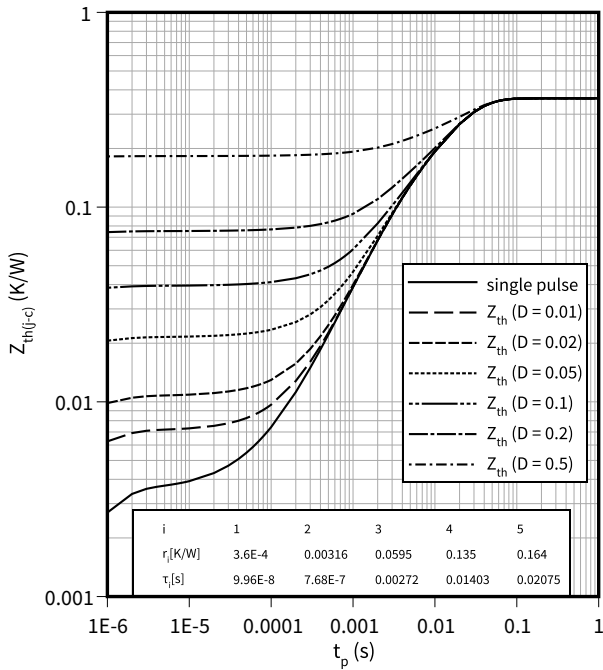

Typical diode forward current as a function of forward voltage

$$I_F = f(V_F)$$

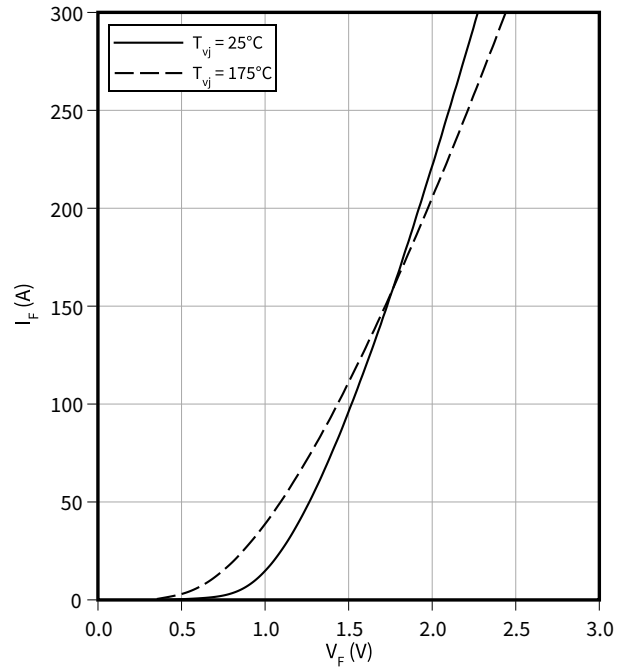

Typical diode forward voltage as a function of junction temperature

$$V_F = f(T_{vj})$$

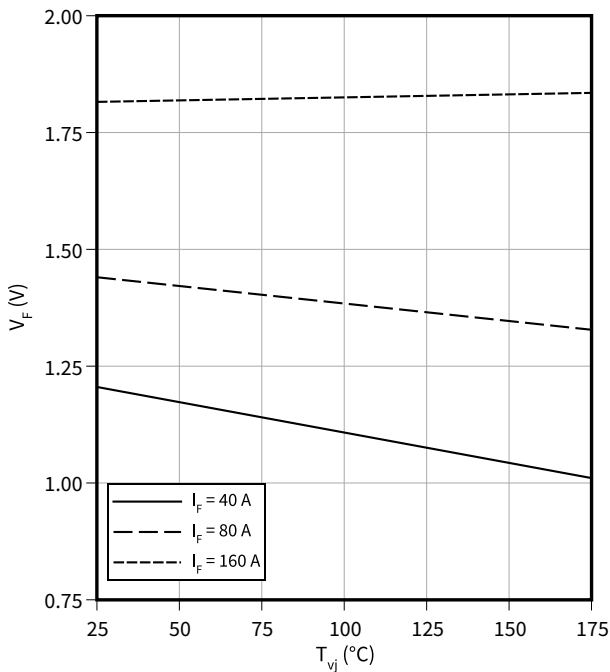

Typical reverse recovery time as a function of diode current slope

$$t_{rr} = f(di_F/dt)$$

$$V_R = 470 \text{ V}, I_F = 160 \text{ A}$$

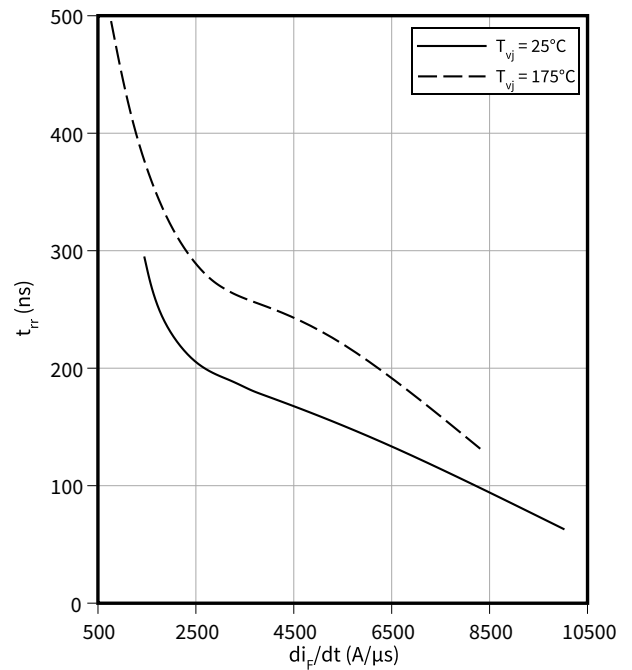

4 Characteristics diagrams

Typical reverse recovery charge as a function of diode current slope

$Q_{rr} = f(di_F/dt)$

$V_R = 470\text{ V}, I_F = 160\text{ A}$

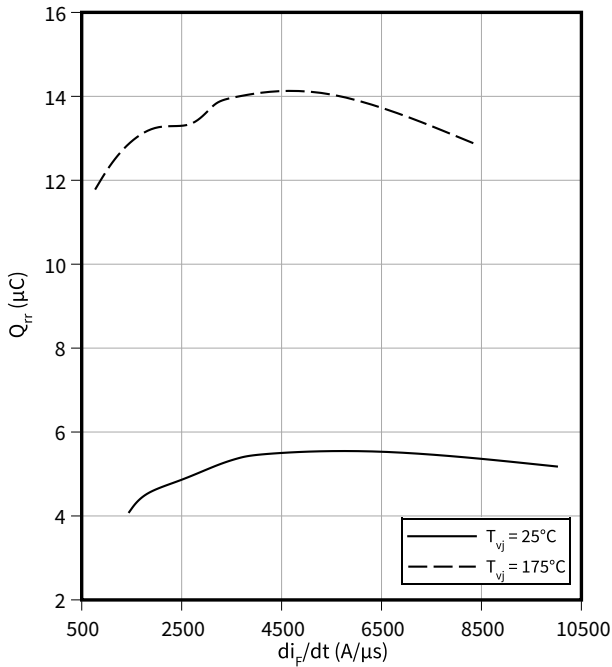

Typical reverse recovery current as a function of diode current slope

$I_{rrm} = f(di_F/dt)$

$V_R = 470\text{ V}, I_F = 160\text{ A}$

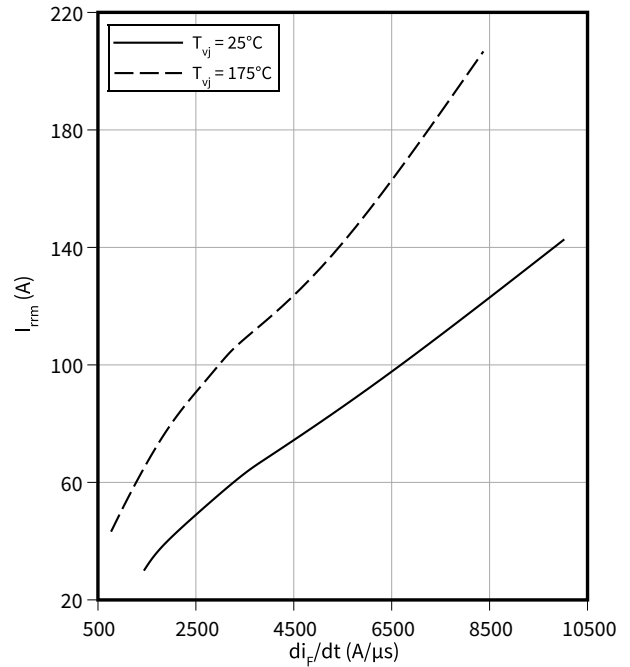

Typical diode peak rate of fall of reverse recovery current as a function of diode current slope

$di_{rr}/dt = f(di_F/dt)$

$V_R = 470\text{ V}, I_F = 160\text{ A}$

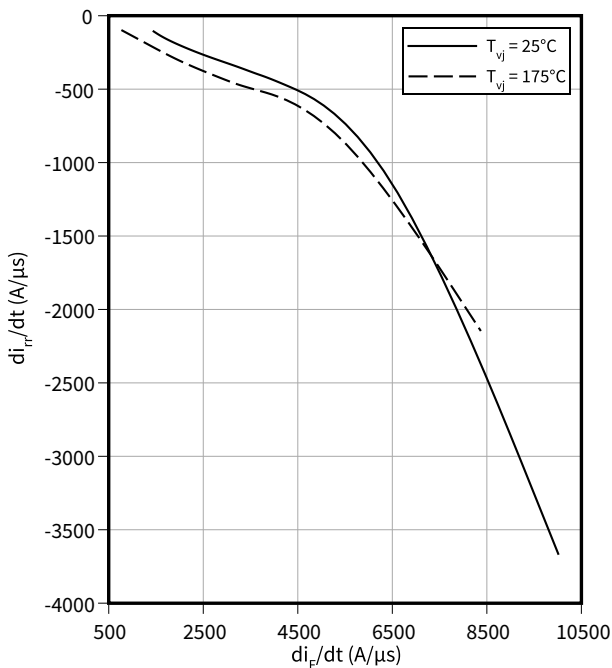

Typical reverse energy losses as a function of diode current slope

$E_{rec} = f(di_F/dt)$

$V_R = 470\text{ V}, I_F = 160\text{ A}$

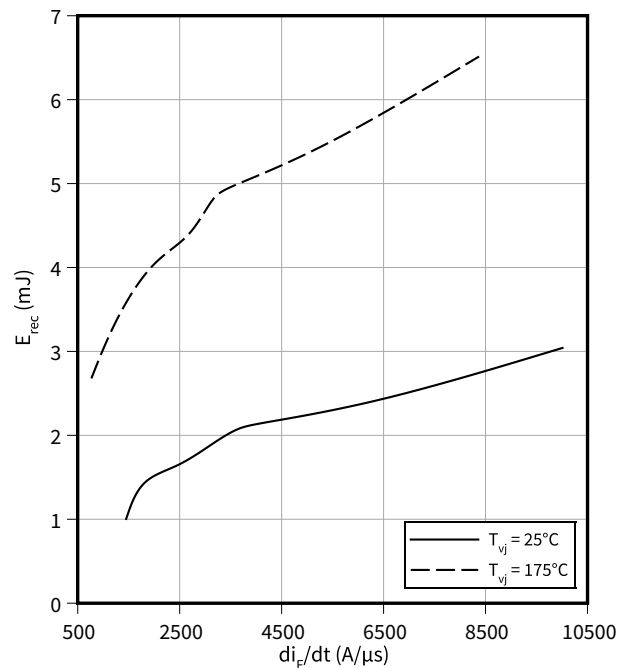

4 Characteristics diagrams

Typical diode current slope as a function of gate resistor

$$di_F/dt = f(R_G)$$

$V_R = 470 \text{ V}$, $I_F = 160 \text{ A}$

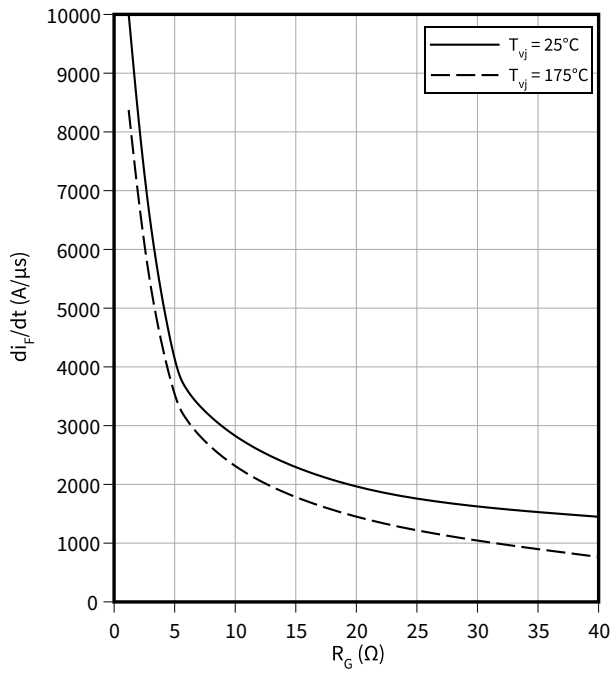

5 Package outlines

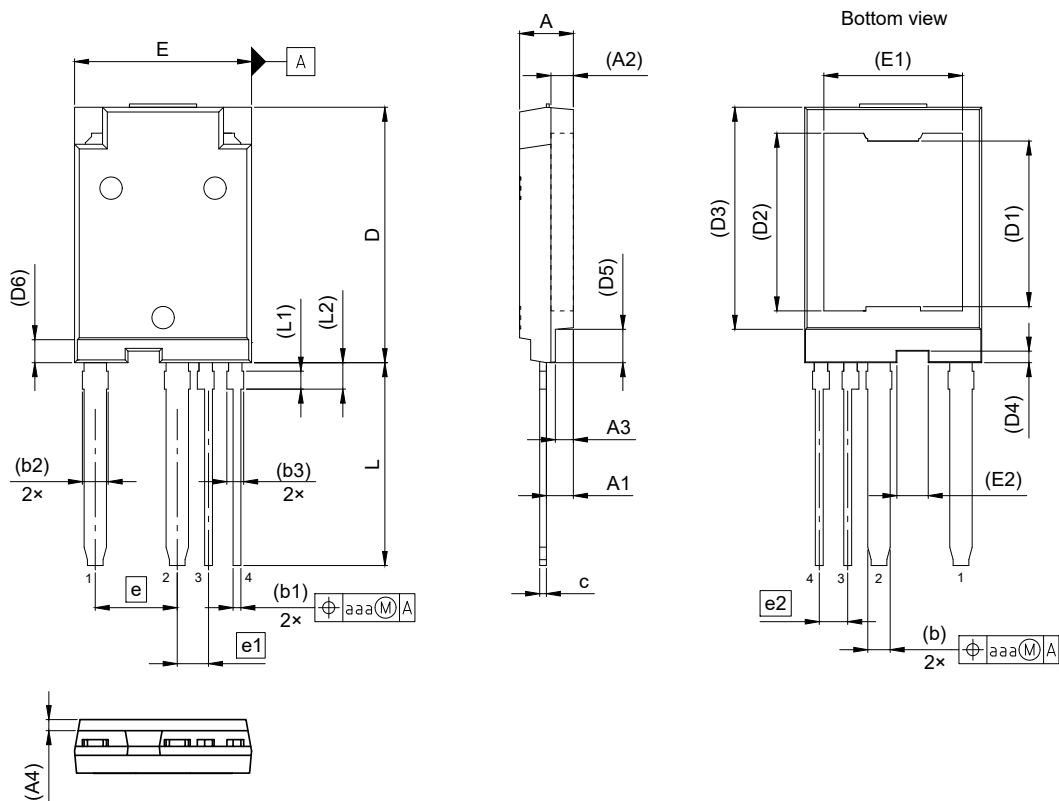

PACKAGE - GROUP
NUMBER: **PG-TO247-4-U06**

DIMENSIONS	MILLIMETERS	
	MIN.	MAX.
A	4.7	4.9
A1	2.16	2.66
A2	2	
A3	1.51	1.71
A4	0.99	
b	2	
b1	0.7	
b2	2.3	
b3	1.5	
c	0.5	0.7
D	22.7	22.9
D1	14.79	
D2	15.86	
D3	19.82	

DIMENSIONS	MILLIMETERS	
	MIN.	MAX.
D4	1.03	
D5	2.98	
D6	2.05	
E	15.7	15.9
E1	12.38	
E2	2.8	
e	7.32	
e1	2.79	
e2	2.54	
L	18.01	18.21
L1	1.6	
L2	2.36	
aaa	0.25	

1) All metal surfaces tin plated except area of cut

2) Mold gate protrusion after degating.

All dimensions are in units mm

The drawing is in compliance with ISO 128-30, Projection Method 3 $\left[\begin{array}{c} \oplus \\ \ominus \end{array} \right]$

Drawing according to ISO 8015, general tolerances

Figure 1

6 Testing conditions

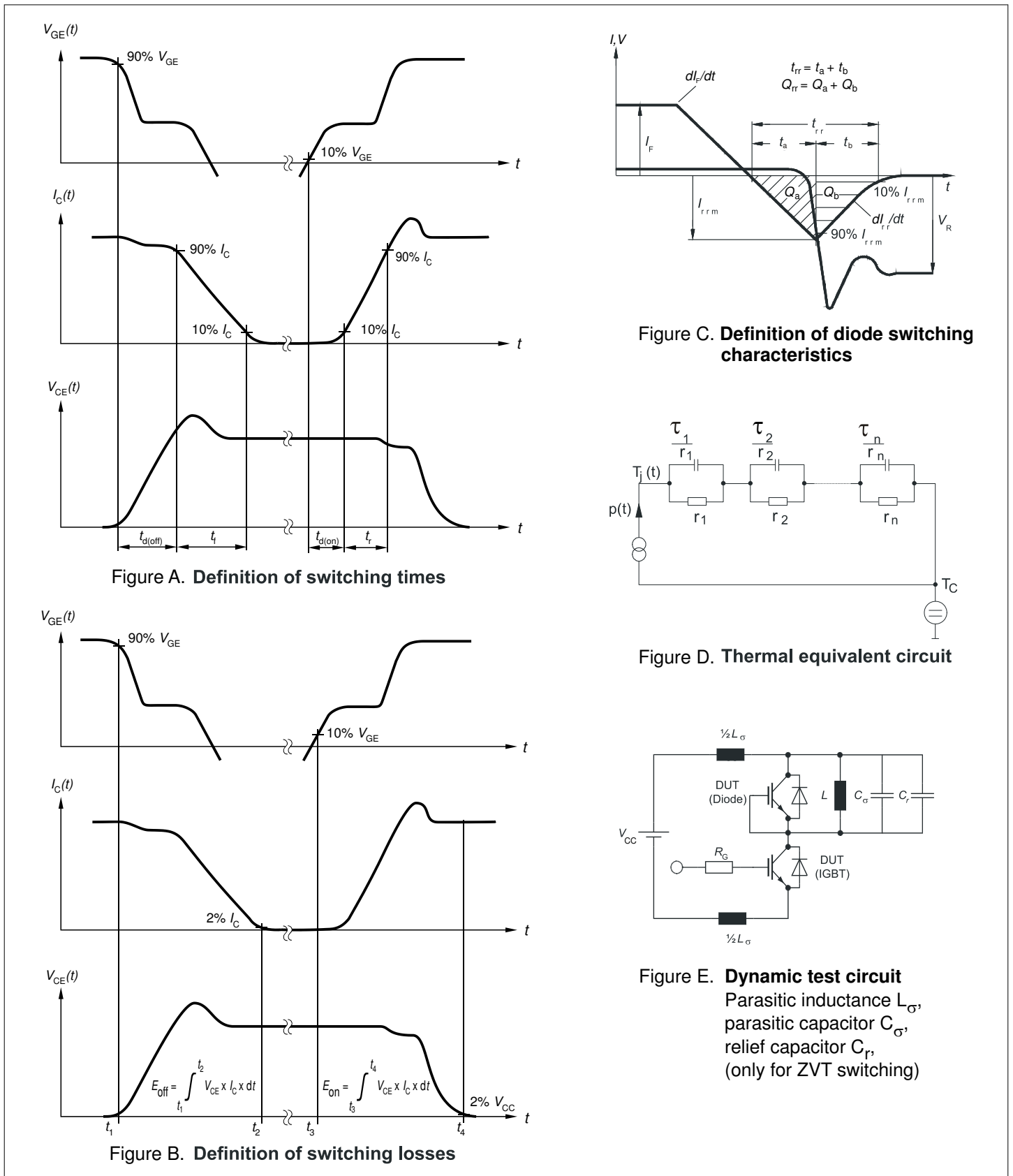

Figure 2

Revision history

Document revision	Date of release	Description of changes
0.10	2024-03-26	Preliminary datasheet
1.00	2024-07-19	Final datasheet

Trademarks

All referenced product or service names and trademarks are the property of their respective owners.

Edition 2024-07-23

Published by

Infineon Technologies AG

81726 Munich, Germany

© 2024 Infineon Technologies AG

All Rights Reserved.

Do you have a question about any aspect of this document?

Email: erratum@infineon.com

Document reference

IFX-ABB842-002

Important notice

The information given in this document shall in no event be regarded as a guarantee of conditions or characteristics ("Beschaffungsgarantie").

With respect to any examples, hints or any typical values stated herein and/or any information regarding the application of the product, Infineon Technologies hereby disclaims any and all warranties and liabilities of any kind, including without limitation warranties of non-infringement of intellectual property rights of any third party.

In addition, any information given in this document is subject to customer's compliance with its obligations stated in this document and any applicable legal requirements, norms and standards concerning customer's products and any use of the product of Infineon Technologies in customer's applications.

The data contained in this document is exclusively intended for technically trained staff. It is the responsibility of customer's technical departments to evaluate the suitability of the product for the intended application and the completeness of the product information given in this document with respect to such application.

Warnings

Due to technical requirements products may contain dangerous substances. For information on the types in question please contact your nearest Infineon Technologies office.

Except as otherwise explicitly approved by Infineon Technologies in a written document signed by authorized representatives of Infineon Technologies, Infineon Technologies' products may not be used in any applications where a failure of the product or any consequences of the use thereof can reasonably be expected to result in personal injury.