



TAOGLAS®



Datasheet

Part No:
TU.66.3H31

Description

Terminal Mount Wideband Antenna with N-Type Connector
Covering 600MHz-8000MHz for 5G/4G and Wi-Fi 6/7 Bands

Features:

Covers all Global Cellular Bands from 600-8000MHz
Covers 2.4, 5.8 and 7.125GHz Wi-Fi Bands
Robust IP67 Waterproof Enclosure
Connector: N-Type(M)
Dims: 125 x Ø22.8
RoHS & Reach Compliant

1.	Introduction	3
2.	Specification	4
3.	Mechanical Drawing	7
4.	Installation Recommendation	8
5.	Packaging	9
6.	Antenna Characteristics	10
7.	Radiation Patterns	14
8.	Application Note	42
9.	Antenna Characteristics	43
10.	Radiation Patterns	47
<hr/>		
	Changelog	75

Ireland & USA
ISO 9001:2015
Certified



Taiwan
ISO 9001:2015
Certified



Taoglas makes no warranties based on the accuracy or completeness of the contents of this document and reserves the right to make changes to specifications and product descriptions at any time without notice. Taoglas reserves all rights to this document and the information contained herein. Reproduction, use or disclosure to third parties without express permission is strictly prohibited.

1. Introduction



The Taoglas TU.66 is a compact, high-performance, unique terminal mount, wideband cellular antenna designed to cover all global 5G, 4G and Wi-Fi Bands between 600 and 8000MHz. It supports all major cellular carriers and Wi-Fi bands including the 7.125GHz band, and delivers excellent efficiency across the full bandwidth. The robust N-Type connector ensures easy integration with terminal-mounted equipment, providing a secure and stable connection. With an high gain and an omnidirectional radiation pattern for improved signal strength, it is ideal for a variety of IoT and M2M applications.

Typical Applications Include:

- Gateways, Routers and Private LTE Networks
- In-Building Connectivity Systems
- Point of Sales Kiosks and Digital Signage
- Connected Industries and Smart Metering

The IP67 rated enclosure that is manufactured from ABS making it an ideal ruggedized solution for both indoor and outdoor environments. The TU.66 is one of several compact cellular antennas from Taoglas designed to enable easy installation in space-constrained environments without compromising on performance.

[Contact](#) your regional Taoglas customer support team for further information or samples.

2. Specification

LTE Electrical									
Band	Frequency (MHz)	Measurement	Efficiency (%)	Average Gain (dB)	Peak Gain (dBi)	Impedance	Polarization	Radiation Pattern	Max. input power
5G NR/4G Band 71	617-698	Metal Box_Port1	94.5	-0.25	4.69	50 Ω	Linear	Omni	50W
		Metal Box_Port2	75.6	-1.21	3.59				
		Metal Box_Port3	86.8	-0.62	2.85				
4G/3G Band 12,13,14,17,28,29	698-824	Metal Box_Port1	90.0	-0.46	4.62				
		Metal Box_Port2	72.6	-1.39	3.38				
		Metal Box_Port3	88.7	-0.52	3.21				
4G/3G/NB-IoT/Cat M Band 5,8,18,19,20,26,27	824-960	Metal Box_Port1	91.1	-0.41	3.38				
		Metal Box_Port2	68.5	-1.65	2.72				
		Metal Box_Port3	90.7	-0.42	3.80				
5G NR/4G Band 21,32,74,75,76	1427-1518	Metal Box_Port1	52.7	-2.78	3.24				
		Metal Box_Port2	34.7	-4.59	1.03				
		Metal Box_Port3	58.1	-2.36	2.79				
4G/3G Band 1,2,3,4,9,23,25,35,39,66	1710-2200	Metal Box_Port1	82.0	-0.86	5.33				
		Metal Box_Port2	78.6	-1.04	6.13				
		Metal Box_Port3	83.4	-0.79	4.70				
4G/3G Band 7,30,38,40,41	2300-2690	Metal Box_Port1	63.2	-1.99	2.88				
		Metal Box_Port2	63.7	-1.96	3.38				
		Metal Box_Port3	65.6	-1.83	2.78				
5G NR/4G Band 22,42,48,77,78,79	3300-5000	Metal Box_Port1	65.5	-1.84	6.86				
		Metal Box_Port2	69.4	-1.59	7.76				
		Metal Box_Port3	66.7	-1.76	7.04				
LTE5200/Wi-Fi5800	5150-5925	Metal Box_Port1	72.7	-1.39	8.28				
		Metal Box_Port2	75.7	-1.21	8.75				
		Metal Box_Port3	74.5	-1.28	8.47				
WiFi - 6GHz	5925-7125	Metal Box_Port1	66.9	-1.74	7.78				
		Metal Box_Port2	67.3	-1.72	8.50				
		Metal Box_Port3	68.2	-1.66	7.61				

*Tested through 3 ports on a metal box as seen in the test set-up photos which represents a router. See section 8 for more test scenarios.

5G/4G Bands					
Band Number	5GNR / FR1 / LTE / LTE-Advanced / WCDMA / HSPA / HSPA+ / TD-SCDMA				
	Uplink	Downlink	Metal Box_Port1	Metal Box_Port2	Metal Box_Port3
B1	1920 to 1980	2110 to 2170	✓	✓	✓
B2	1850 to 1910	1930 to 1990	✓	✓	✓
B3	1710 to 1785	1805 to 1880	✓	✓	✓
B4	1710 to 1755	2110 to 2155	✓	✓	✓
B5	824 to 849	869 to 894	✓	✓	✓
B7	2500 to 2570	2620 to 2690	✓	✓	✓
B8	880 to 915	925 to 960	✓	✓	✓
B9*	1749.9 to 1784.9	1844.9 to 1879.9	✓	✓	✓
B11	1427.9 to 1447.9	1475.9 to 1495.9	✓	✓	✓
B12	699 to 716	729 to 746	✓	✓	✓
B13	777 to 787	746 to 756	✓	✓	✓
B14	788 to 798	758 to 768	✓	✓	✓
B17	704 to 716	734 to 746	✓	✓	✓
B18	815 to 830	860 to 875	✓	✓	✓
B19	830 to 845	875 to 890	✓	✓	✓
B20	832 to 862	791 to 821	✓	✓	✓
B21	1447.9 to 1462.9	1495.9 to 1510.9	✓	✓	✓
B22*	3410 to 3490	3510 to 3590	✓	✓	✓
B23*	2000 to 2020	2180 to 2200	✓	✓	✓
B24	1626.5 to 1660.5	1525 to 1559	✓	✓	✓
B25	1850 to 1915	1930 to 1995	✓	✓	✓
B26	814 to 849	859 to 894	✓	✓	✓
B27*	807 to 824	852 to 869	✓	✓	✓
B28	703 to 748	758 to 803	✓	✓	✓
B29		717 to 728	✓	✓	✓
B30	2305 to 2315	2350 to 2360	✓	✓	✓
B31	452.5 to 457.5	462.5 to 467.5	✗	✗	✗
B32		1452 to 1496	✓	✓	✓
B34		2010 to 2025	✓	✓	✓
B35		1850 to 1910	✓	✓	✓
B36		1930 to 1990	✓	✓	✓
B37		1910 to 1930	✓	✓	✓
B38		2570 to 2620	✓	✓	✓
B39		1880 to 1920	✓	✓	✓
B40		2300 to 2400	✓	✓	✓
B41		2496 to 2690	✓	✓	✓
B42		3400 to 3600	✓	✓	✓
B43		3600 to 3800	✓	✓	✓
B45		1447 to 1467	✓	✓	✓
B46		5150 to 5925	✓	✓	✓
B47		5855 to 5925	✓	✓	✓
B48		3550 to 3700	✓	✓	✓
B49		3550 to 3700	✓	✓	✓
B50		1432 to 1517	✓	✓	✓
B51		1427 to 1432	✓	✓	✓
B52		3300 to 3400	✓	✓	✓
B53		2483.5 to 2495	✓	✓	✓
B65	1920 to 2010	2110 to 2200	✓	✓	✓
B66	1710 to 1780	2110 to 2200	✓	✓	✓
B68	698 to 728	753 to 783	✓	✓	✓
B69		2570 to 2620	✓	✓	✓
B70	1695 to 1710	1995 to 2020	✓	✓	✓
B71	663 to 698	617 to 652	✓	✓	✓
B72	451 to 456	461 to 466	✗	✗	✗
B73	450 to 455	460 to 465	✗	✗	✗
B74	1427 to 1470	1475 to 1518	✓	✓	✓
B75		1432 to 1517	✓	✓	✓
B76		1427 to 1432	✓	✓	✓
B77		3300 to 4200	✓	✓	✓
B78		3300 to 3800	✓	✓	✓
B79		4400 to 5000	✓	✓	✓
B85	698 to 716	728 to 746	✓	✓	✓
B87	410 to 415	420 to 425	✗	✗	✗
B88	412 to 417	422 to 427	✗	✗	✗

Mechanical	
Dimensions	Length 125 x \varnothing 22.8mm
Weight	55g
Material	ABS
Connector	N-Type (M)

Environmental	
Waterproof Rating	IP67
Operation Temperature	-40°C to 85°C
Storage Temperature	-40°C to 85°C
Relative Humidity	Non-condensing 65°C 95% RH

3. Mechanical Drawing

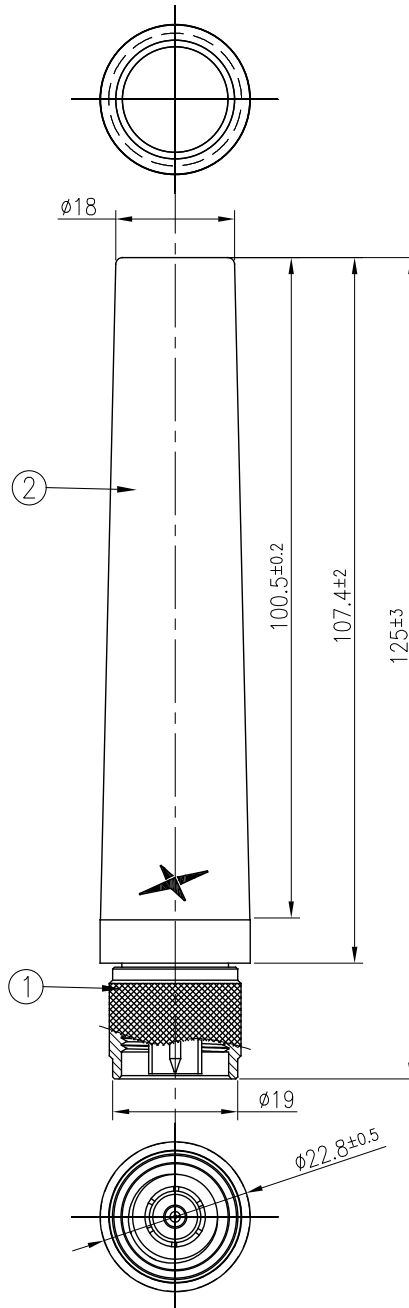

	Name	Material	Finish	QTY
1	N-Type(W)	Brass	Ni plated	1
2	TU.60 Housing	ABS+PC	Black	1

4. Installation Recommendation

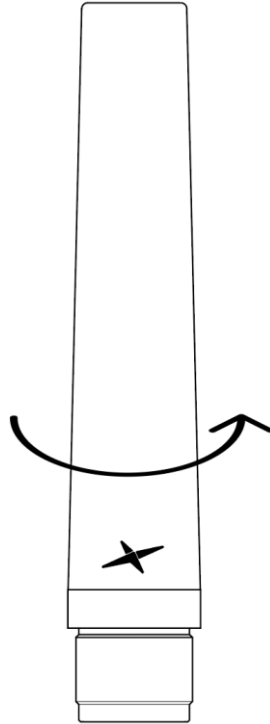

The recommended mounting torque for the TU.66 is 5 Nm

The maximum torque that can be applied is 15 Nm
and anything in excess of this value may cause damage to the product.

5. Packaging

1pc TU.66.3H31 per PE Bag
Weight: 55g

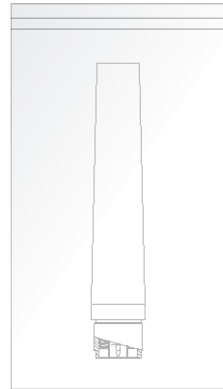

50pcs TU.66.3H31 per Large PE Bag
Weight: 2.75Kg

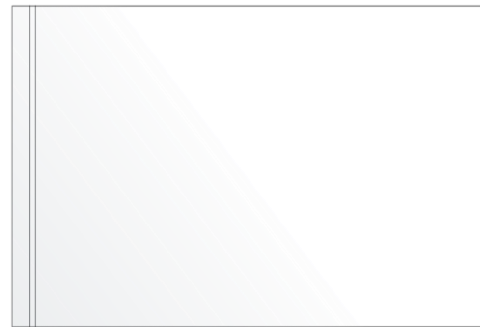

200pcs TU.66.3H31 per Carton
Dimensions: 320*250*230mm
Weight: 11Kg

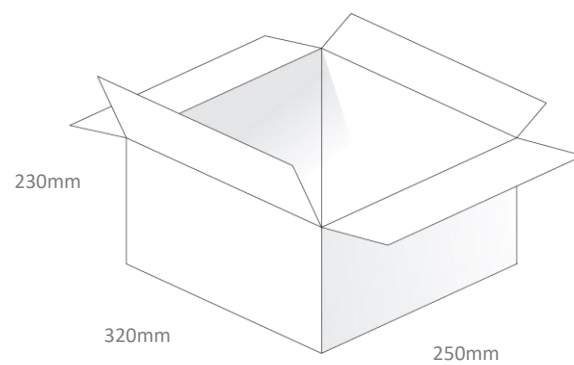

6. Antenna Characteristics

6.1 Test Setup

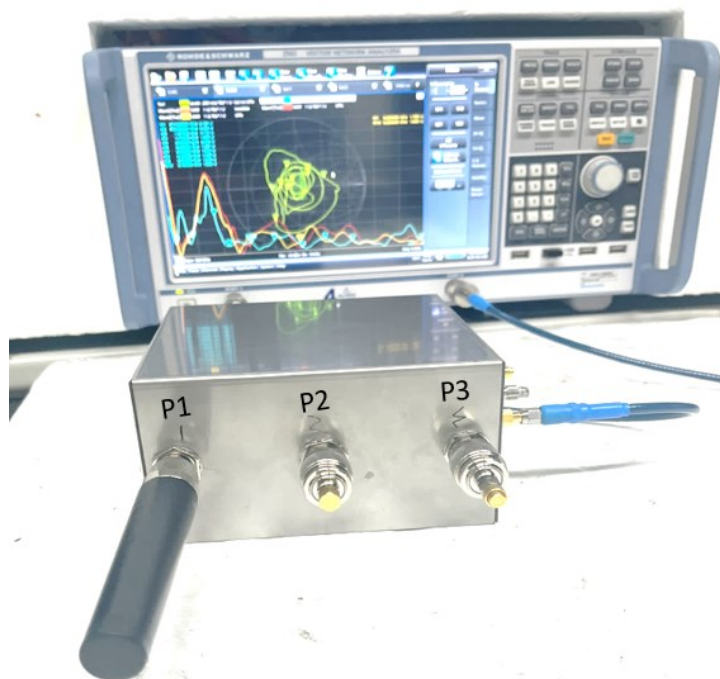
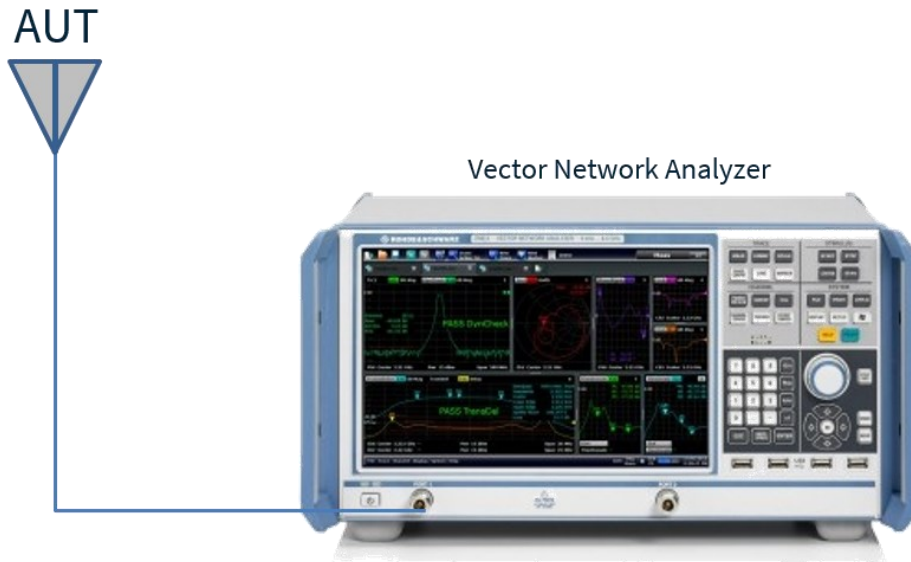

VNA Test Set-up
 (The Metal box set up above represents a router set up)
 P1: Port 1
 P2: Port 2
 P3: Port 3

6.2 Return Loss

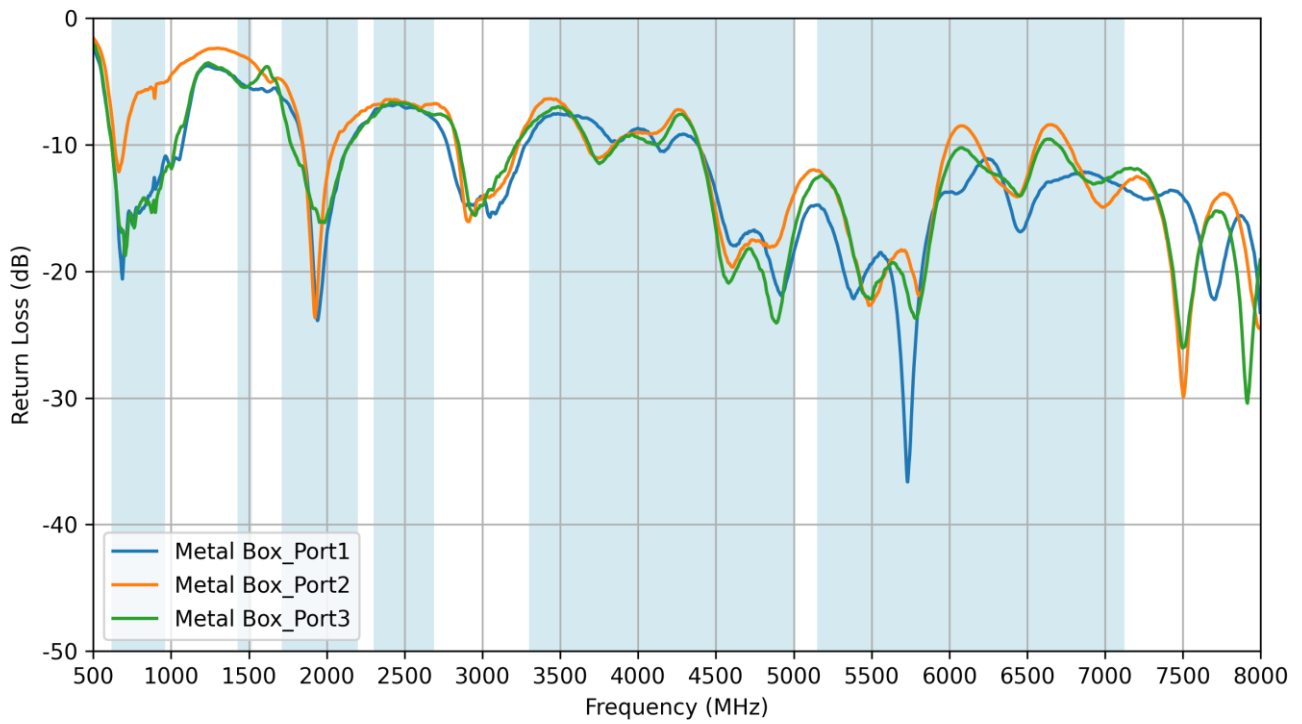

6.3 VSWR

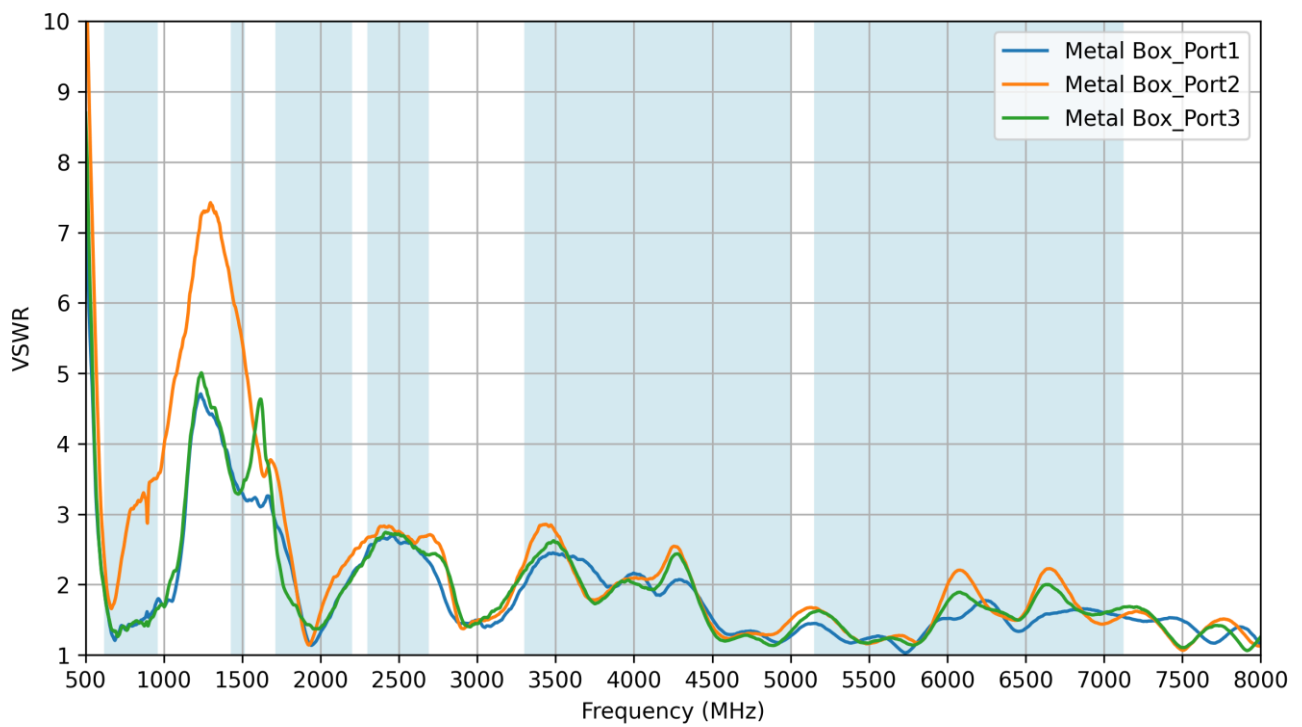

6.4 Efficiency

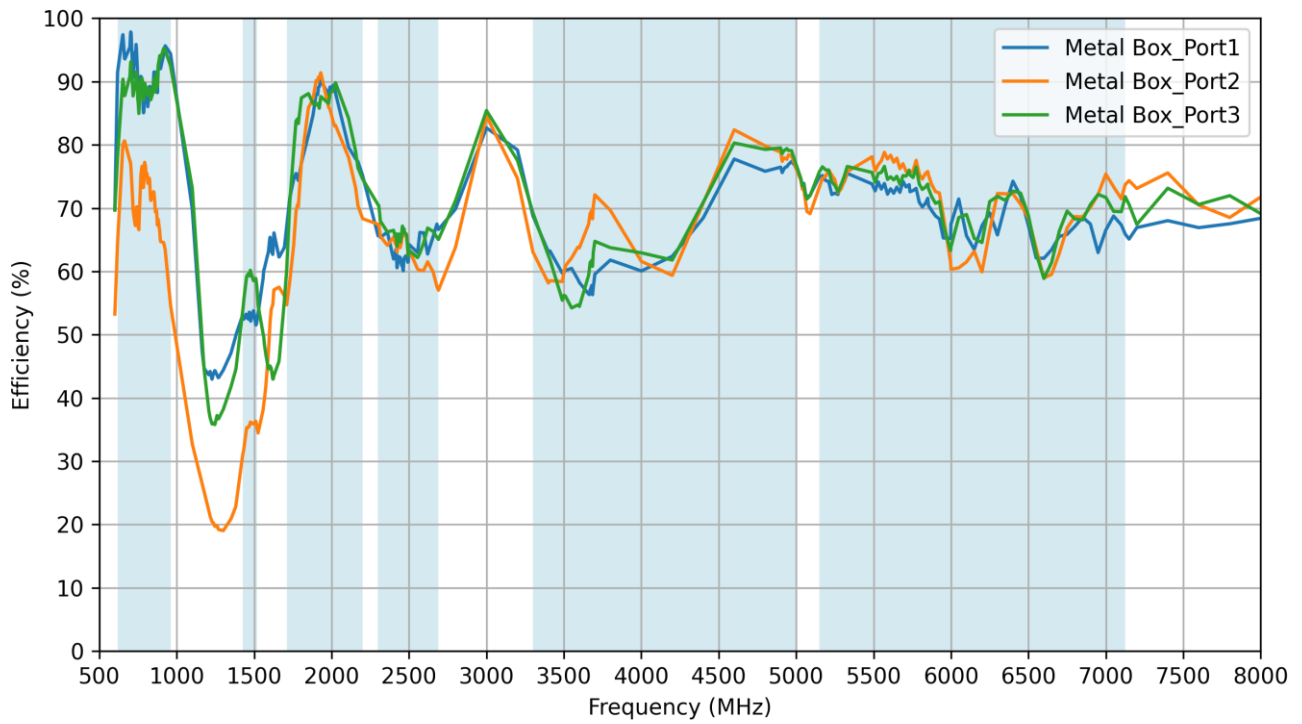

6.5 Average Gain

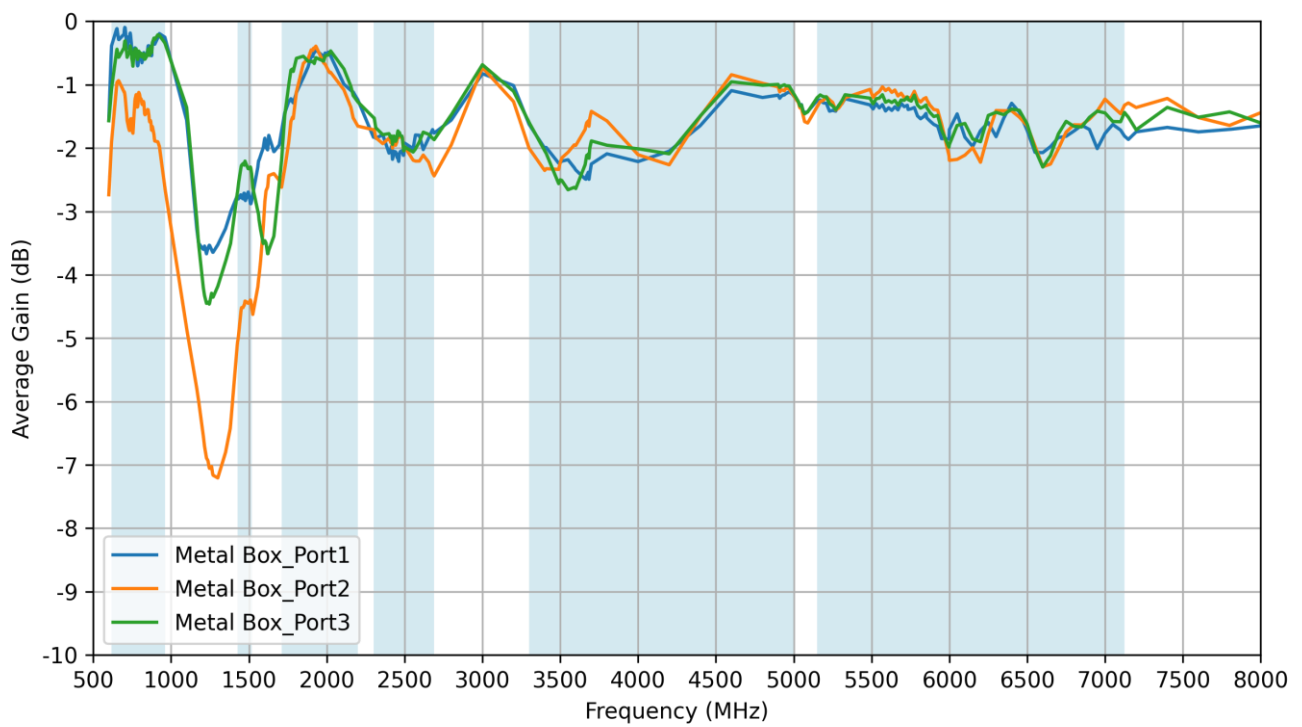

6.6 Peak Gain

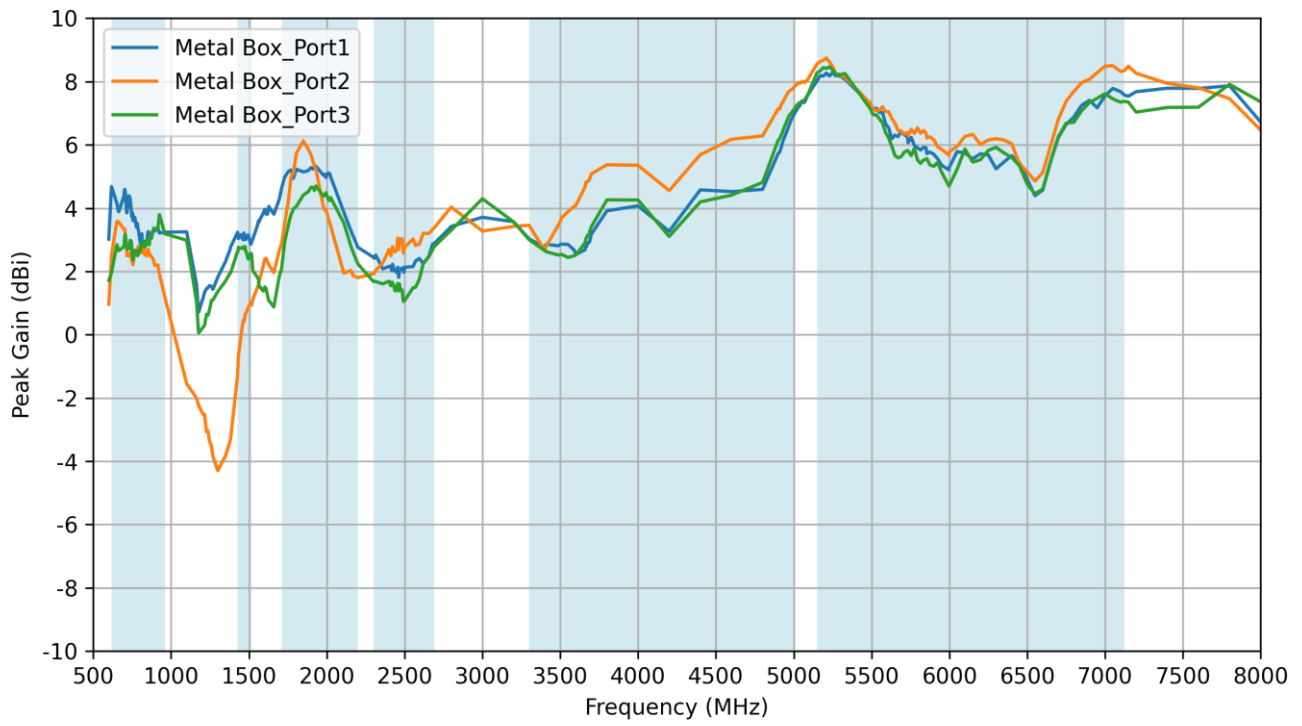

7. Radiation Patterns

7.1 Test Setup

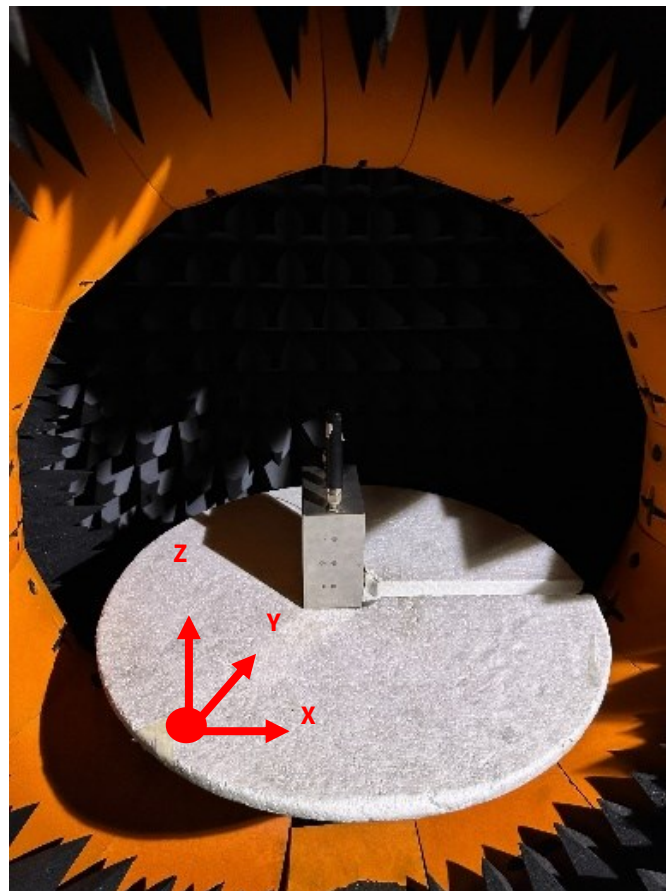
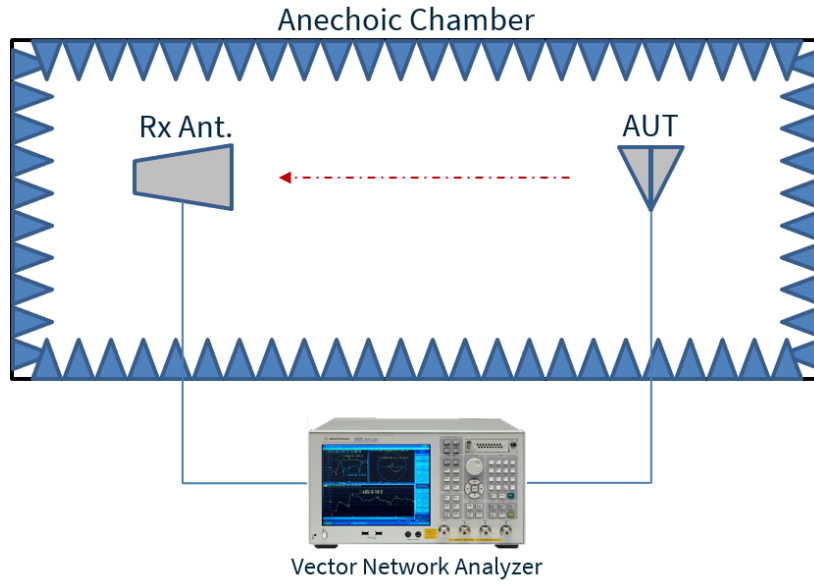

VNA Test Set-up
(The Metal box set up above represents a router set up)

7.2 Metal Box_Port1 Patterns at 652MHz

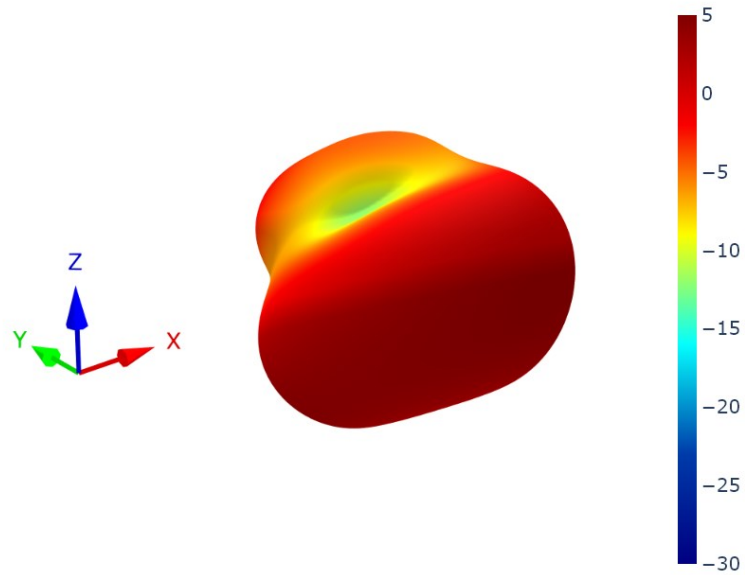

XZ Plane YZ Plane XY Plane

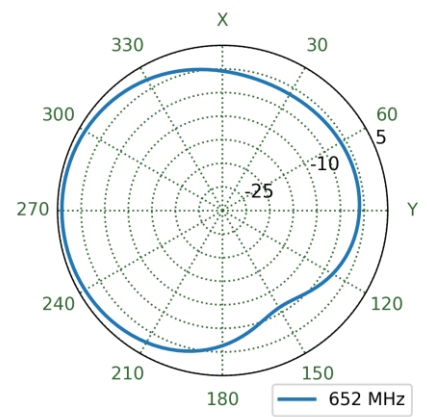
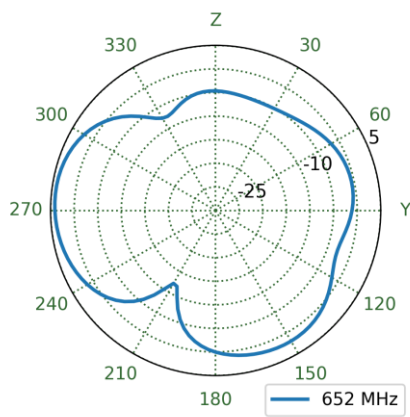
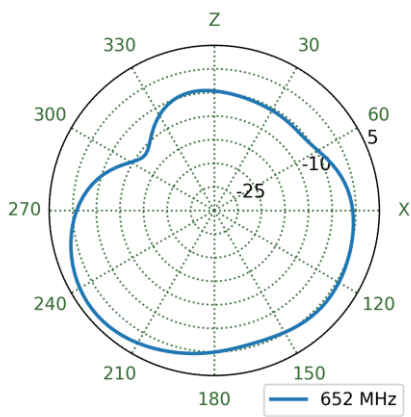

7.5 Metal Box_Port1 Patterns at 751MHz

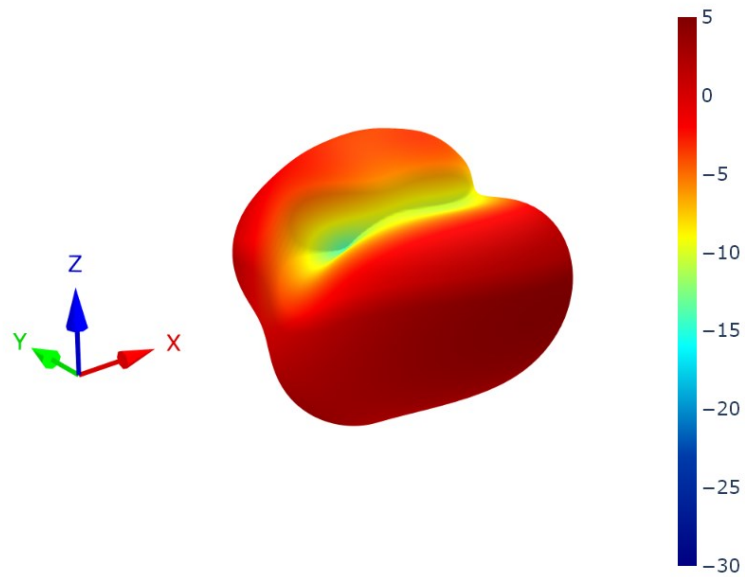

XZ Plane YZ Plane XY Plane

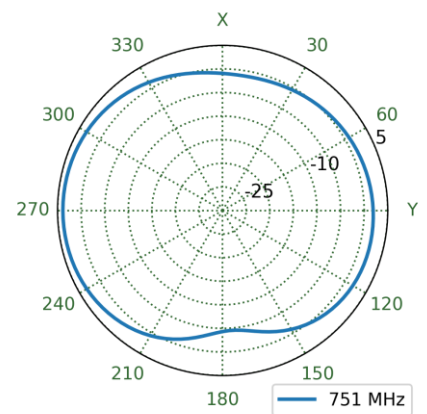
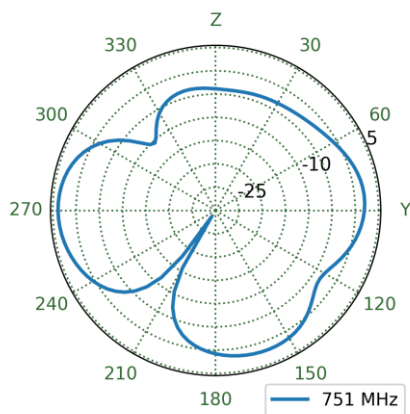
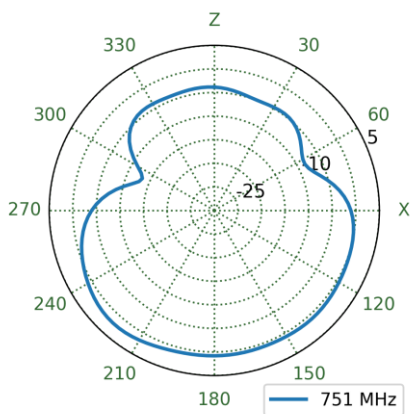

7.6 Metal Box_Port2 Patterns at 751MHz

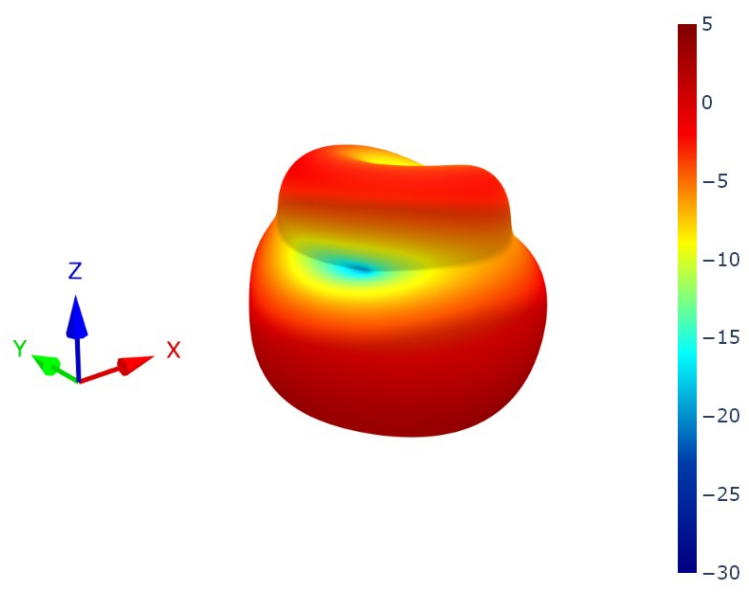

XZ Plane YZ Plane XY Plane

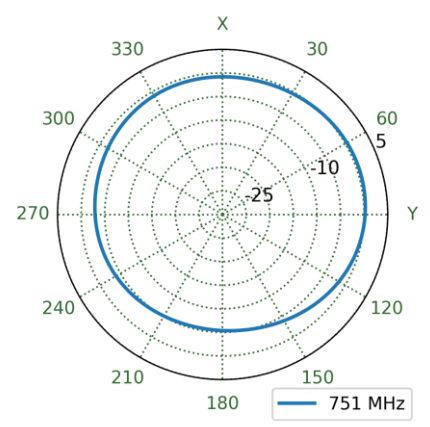
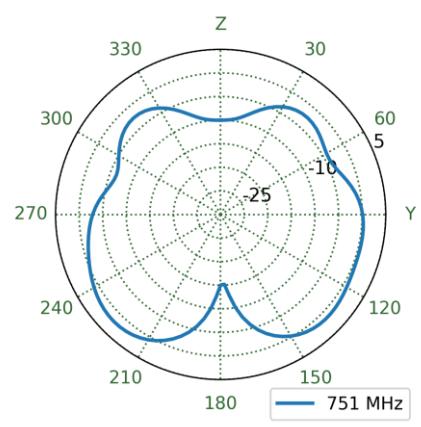
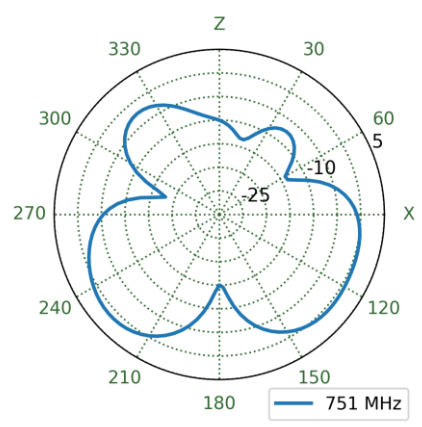

7.7 Metal Box_Port3 Patterns at 751MHz

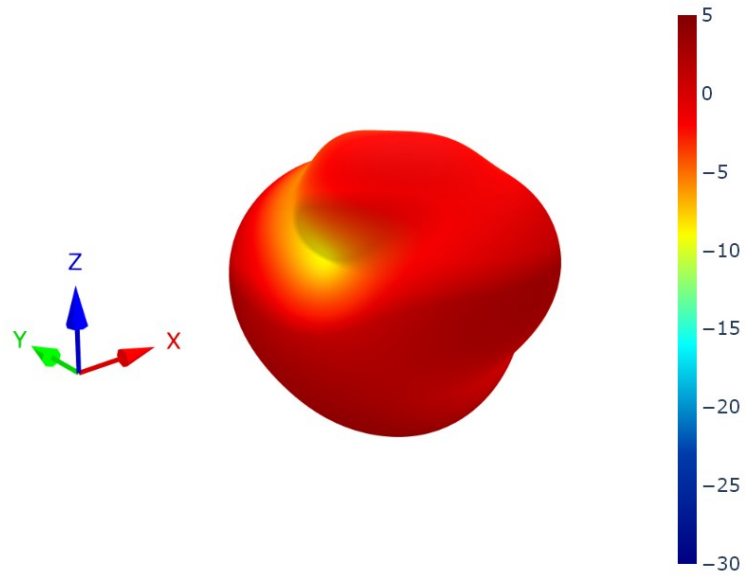

XZ Plane YZ Plane XY Plane

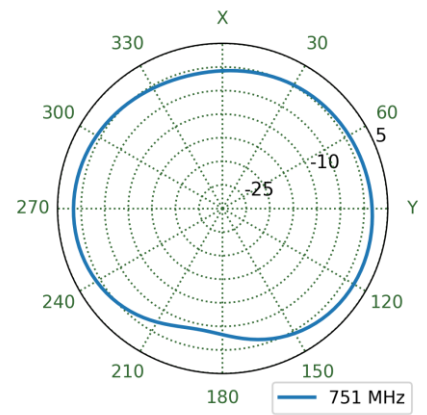
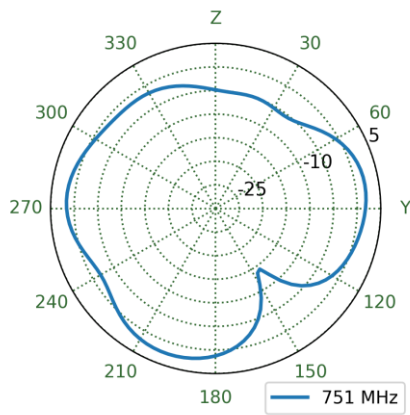
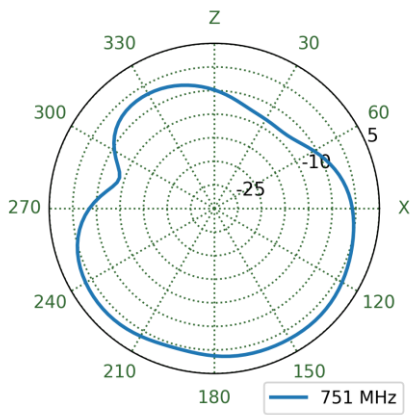

7.12 Metal Box_Port2 Patterns at 1475MHz

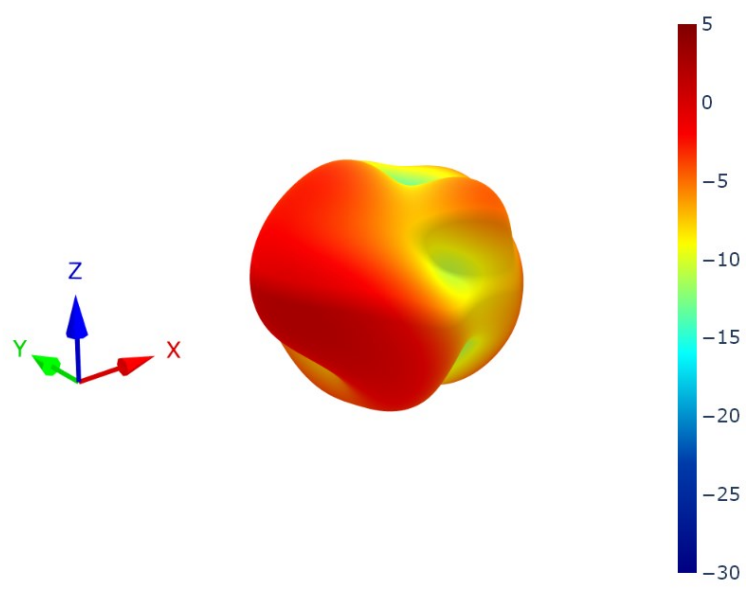

XZ Plane YZ Plane XY Plane

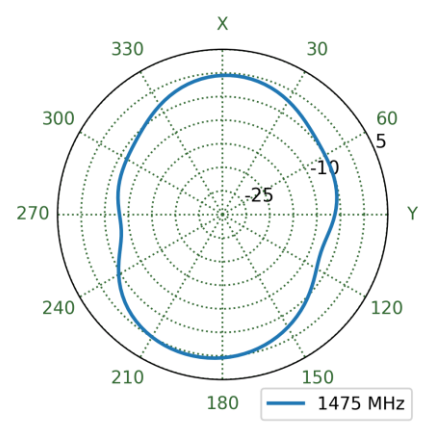
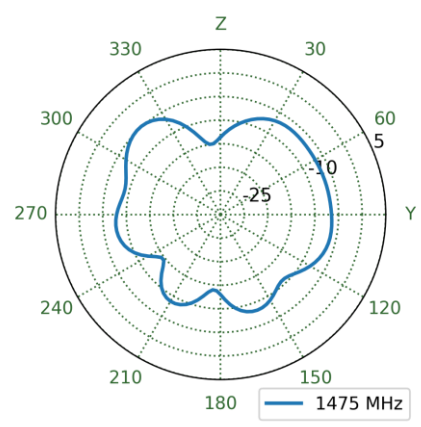
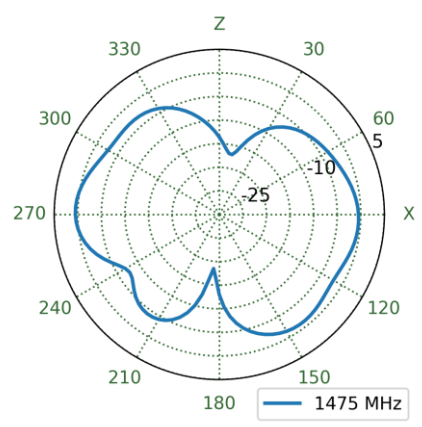

7.13 Metal Box_Port3 Patterns at 1475MHz

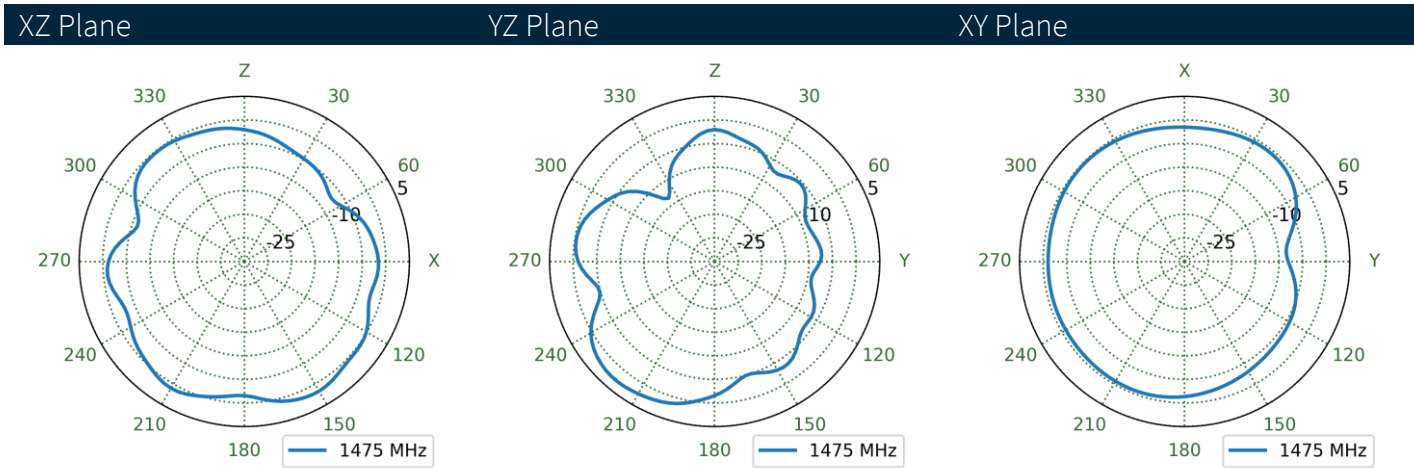
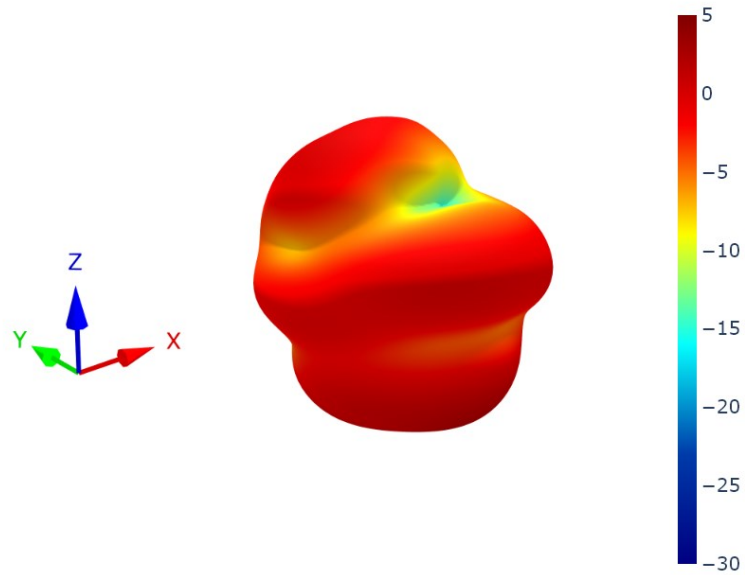

7.14 Metal Box_Port1 Patterns at 1930MHz

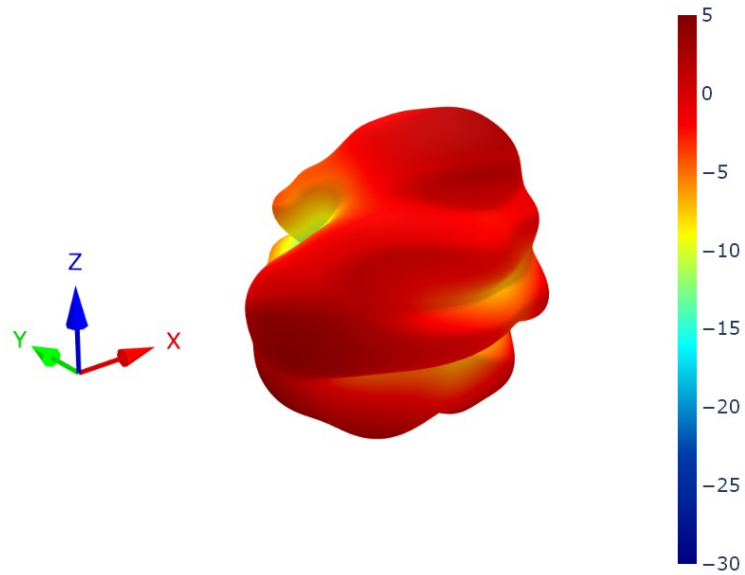

XZ Plane YZ Plane XY Plane

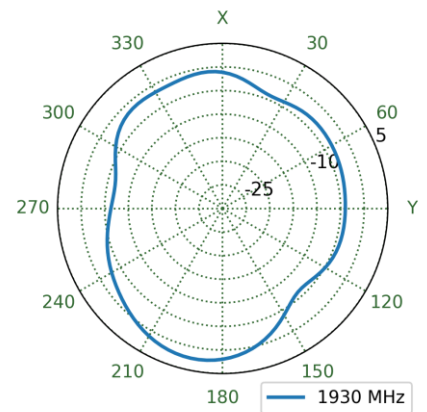
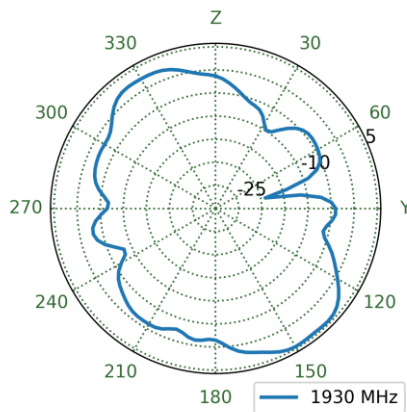
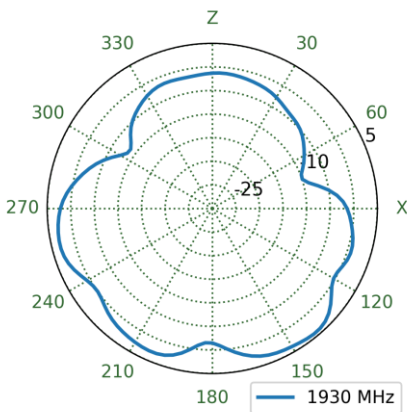

7.15 Metal Box_Port2 Patterns at 1930MHz

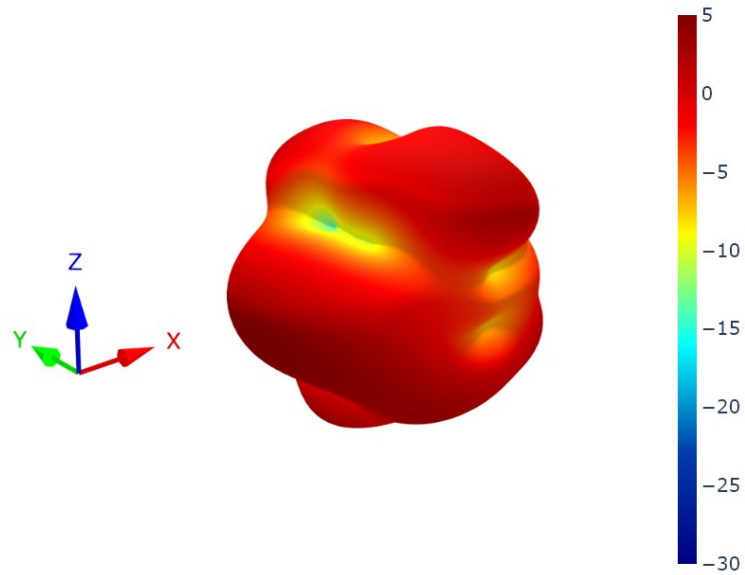

XZ Plane YZ Plane XY Plane

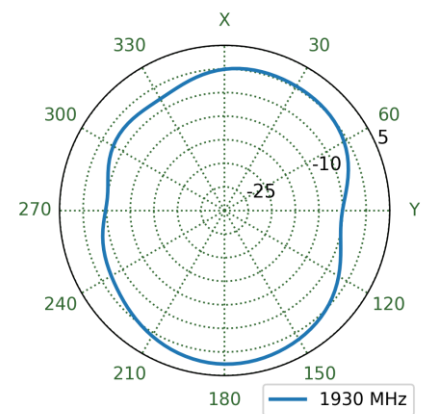
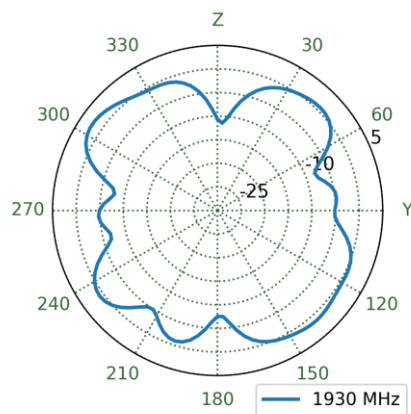
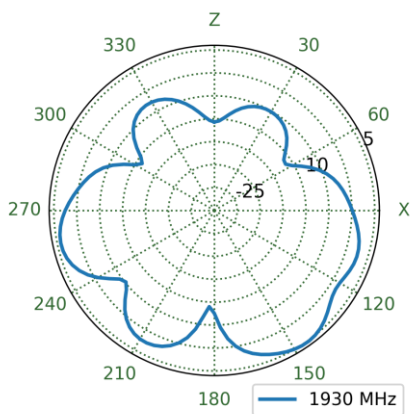

7.16 Metal Box_Port3 Patterns at 1930MHz

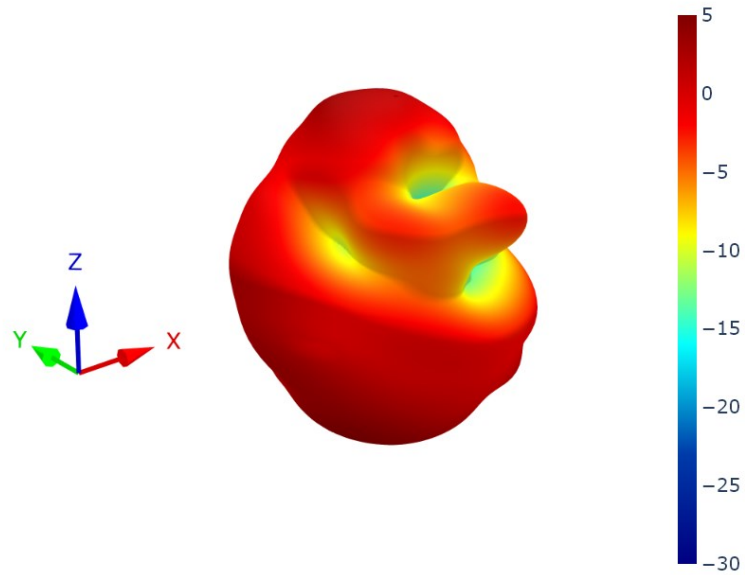

XZ Plane YZ Plane XY Plane

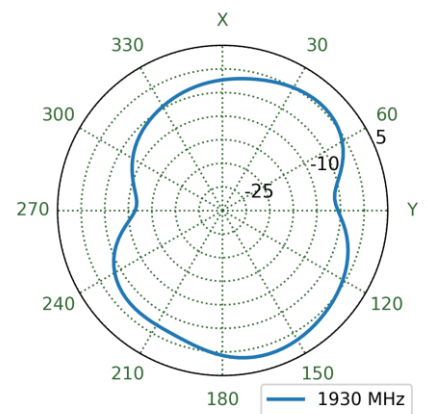
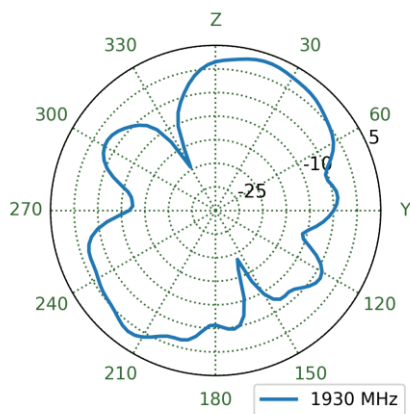
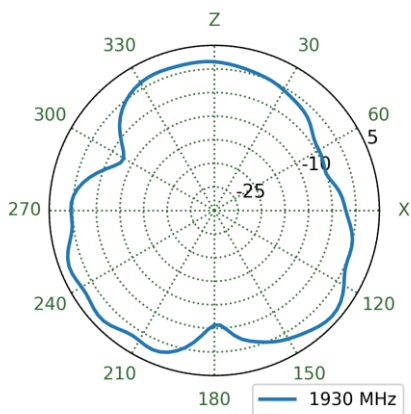

7.17 Metal Box_Port1 Patterns at 2496MHz

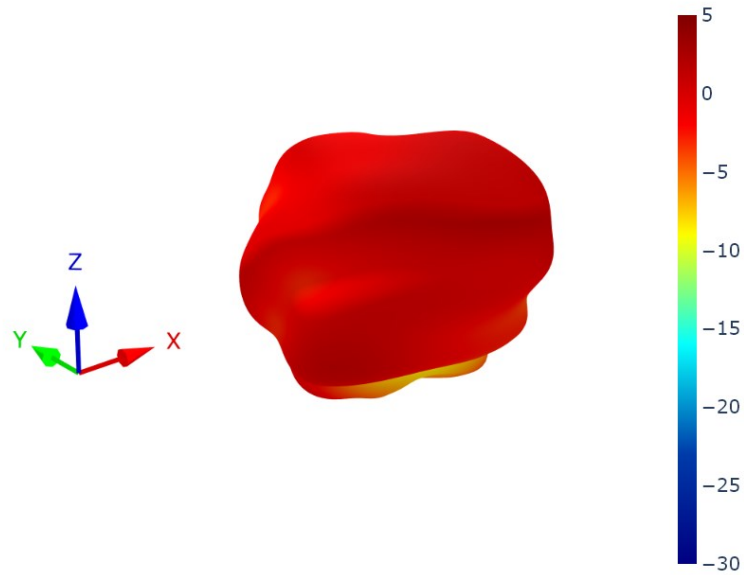

XZ Plane YZ Plane XY Plane

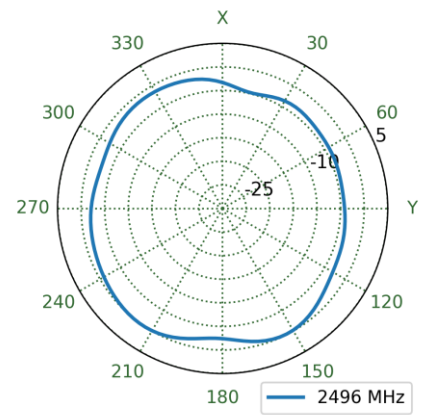
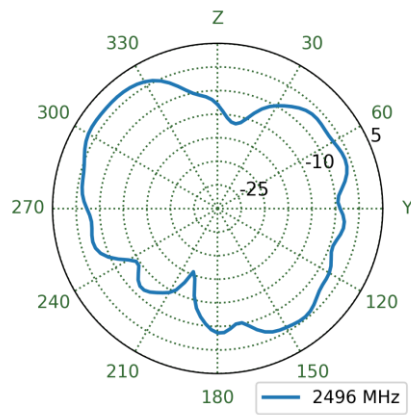
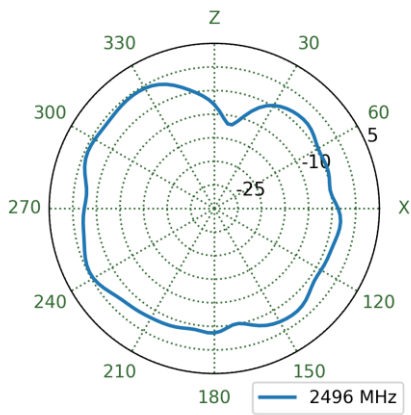

7.18 Metal Box_Port2 Patterns at 2496MHz

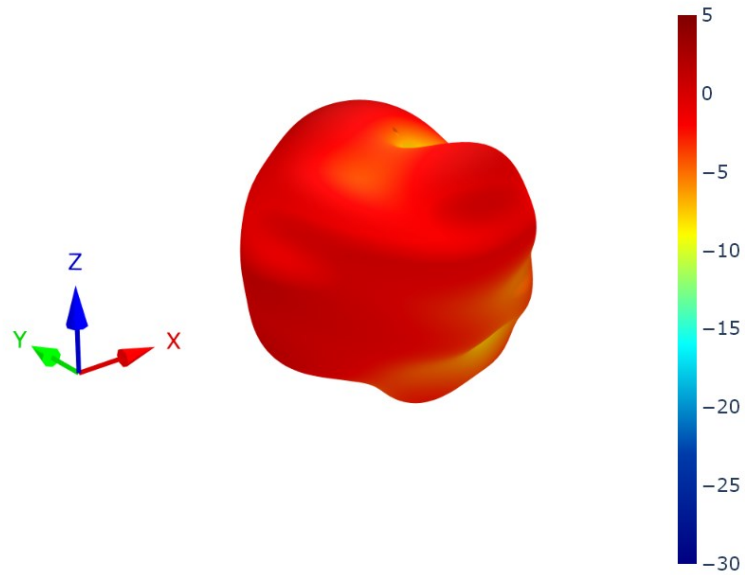

XZ Plane YZ Plane XY Plane

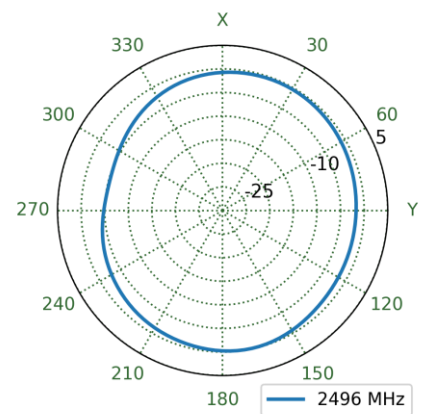
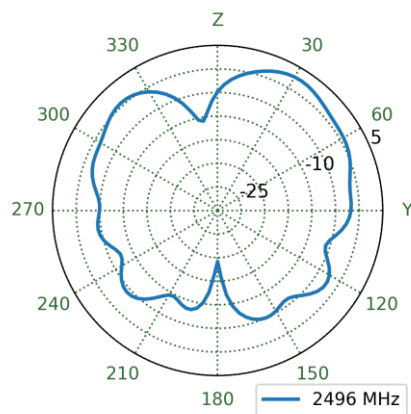
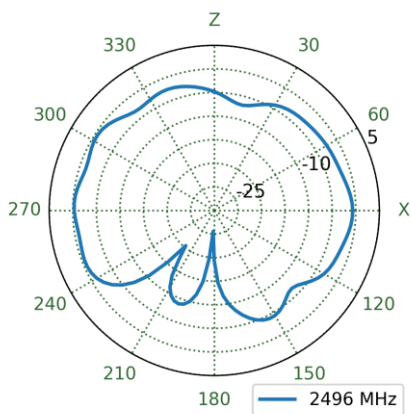

7.19 Metal Box_Port3 Patterns at 2496MHz

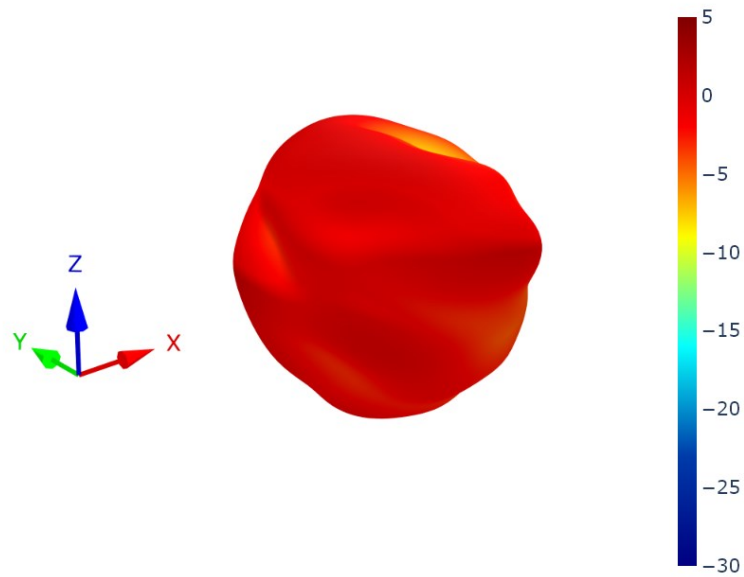

XZ Plane YZ Plane XY Plane

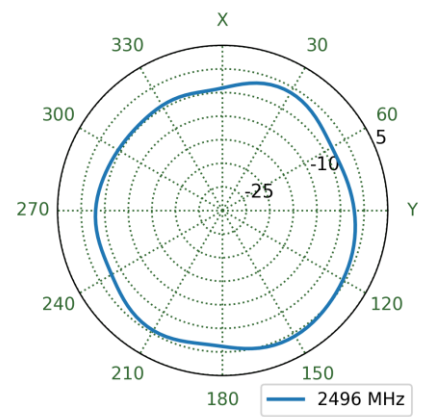
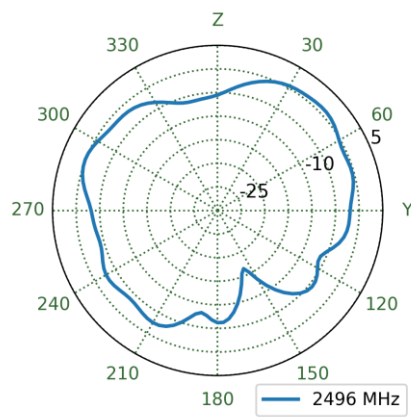
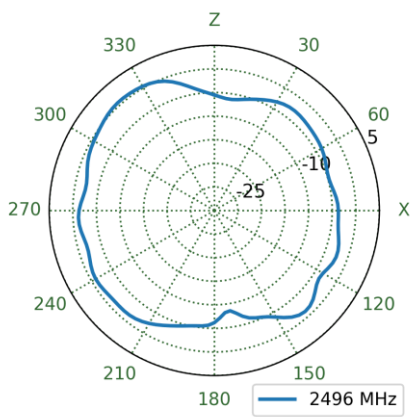

7.20 Metal Box_Port1 Patterns at 4200MHz

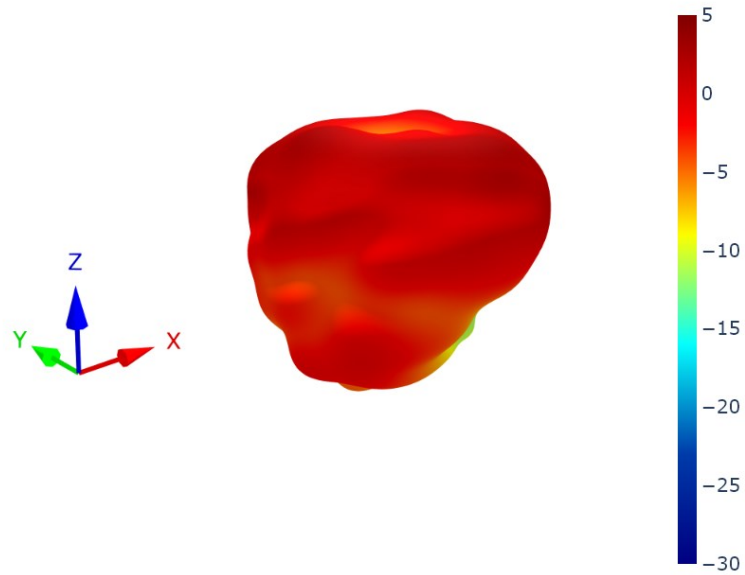

XZ Plane YZ Plane XY Plane

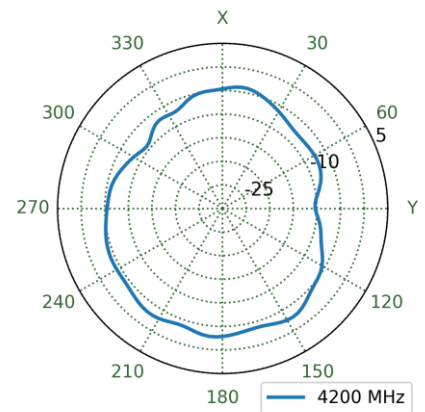
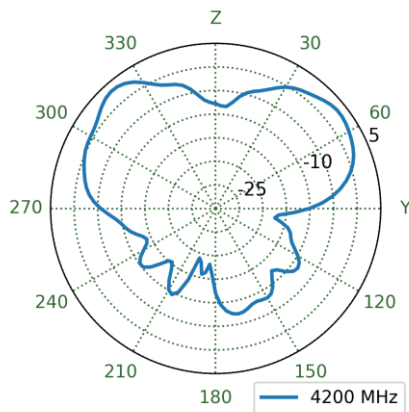
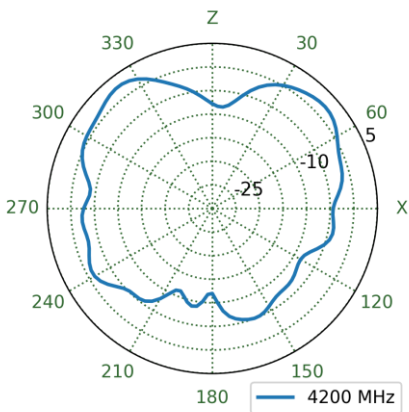

7.21 Metal Box_Port2 Patterns at 4200MHz

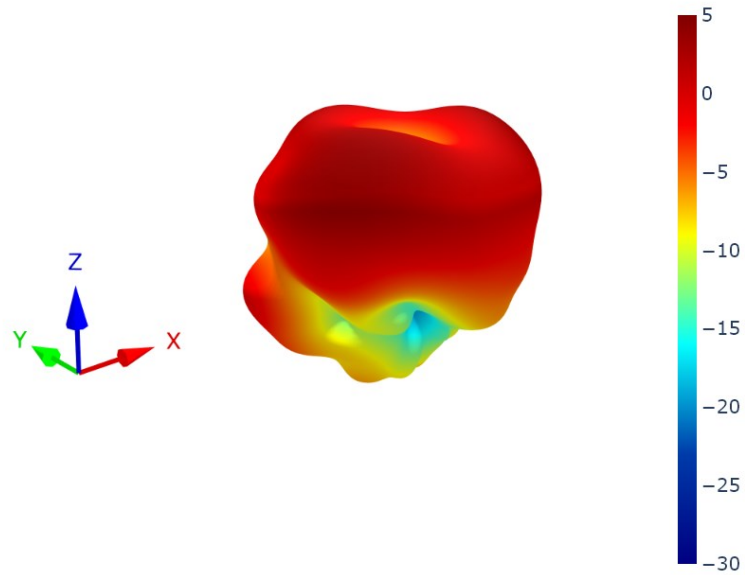

XZ Plane YZ Plane XY Plane

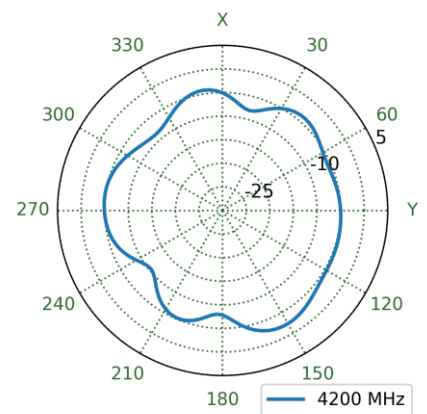
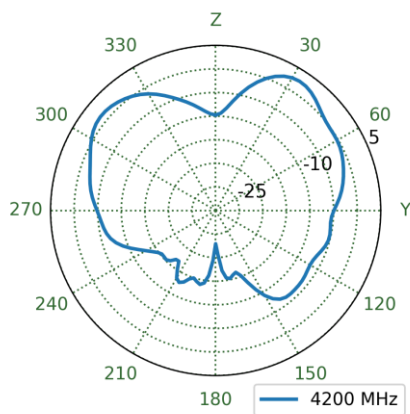
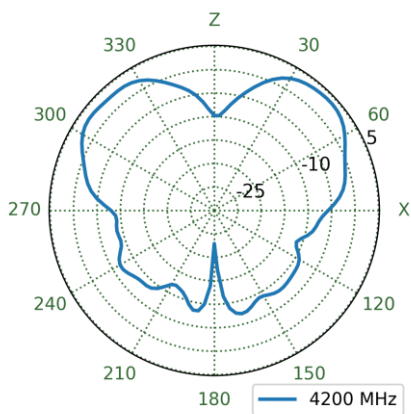

7.22 Metal Box_Port3 Patterns at 4200MHz

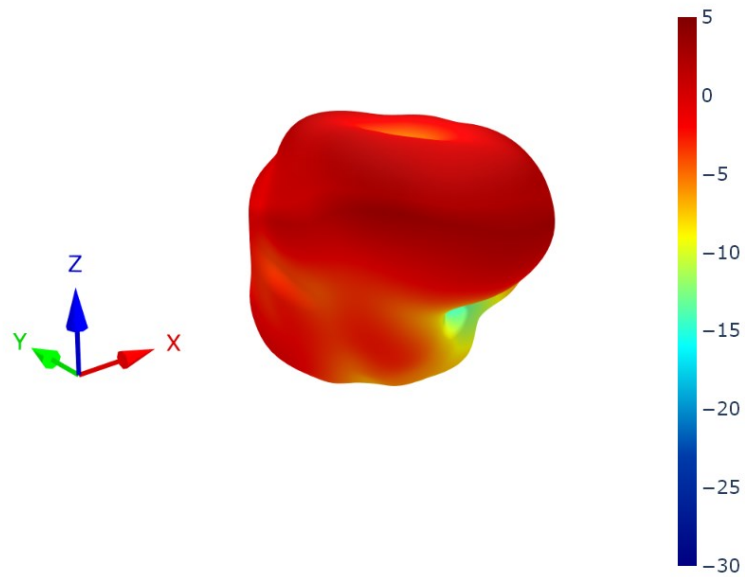

XZ Plane YZ Plane XY Plane

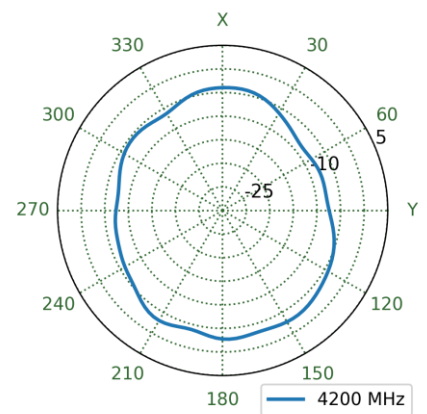
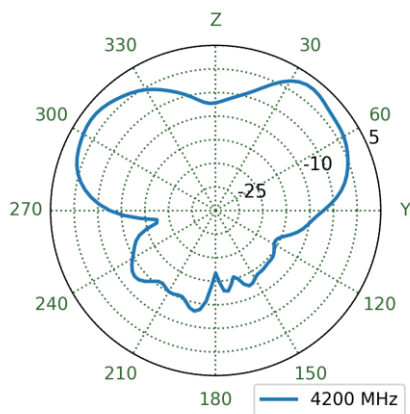
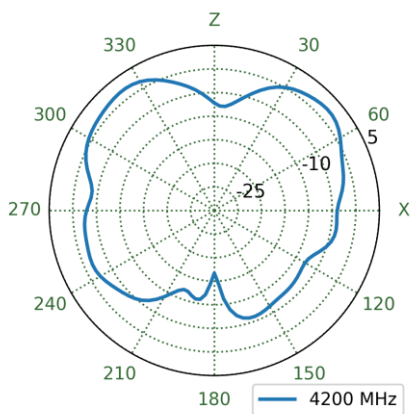

7.23 Metal Box_Port1 Patterns at 5550MHz

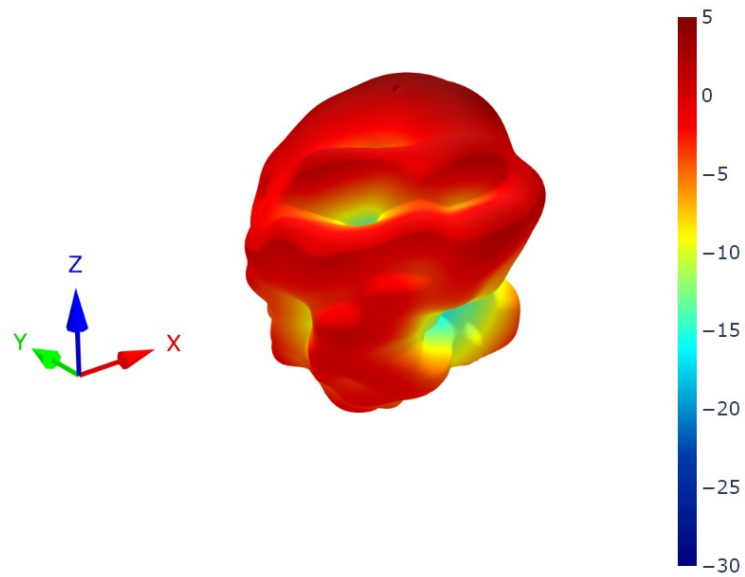

XZ Plane YZ Plane XY Plane

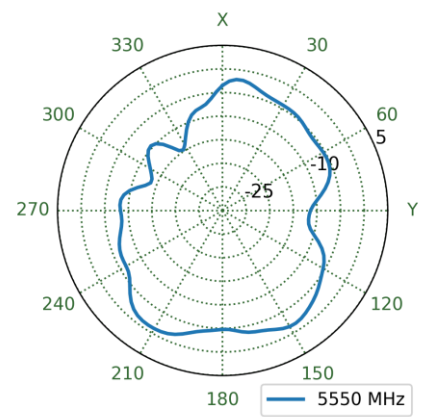
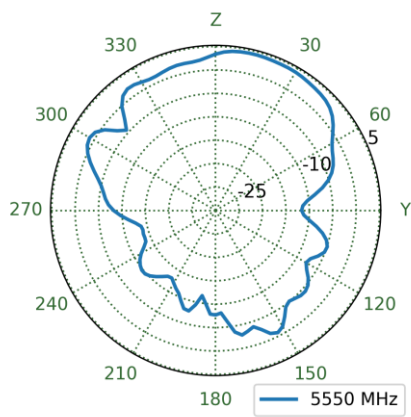
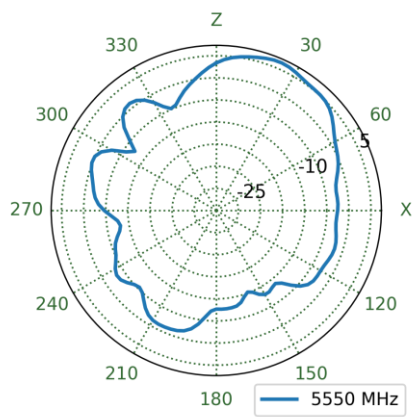

7.24 Metal Box_Port2 Patterns at 5550MHz

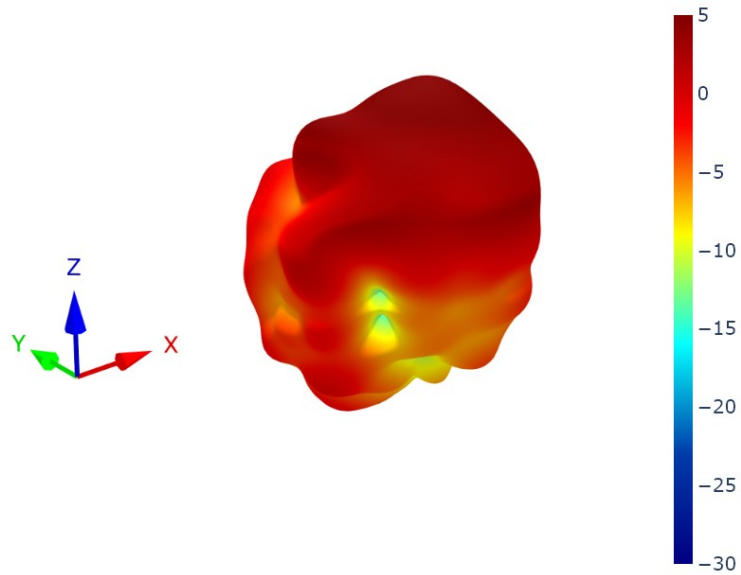

XZ Plane YZ Plane XY Plane

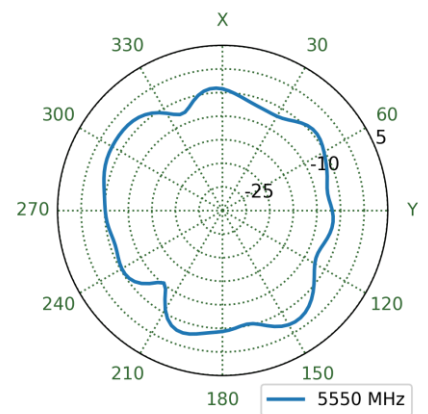
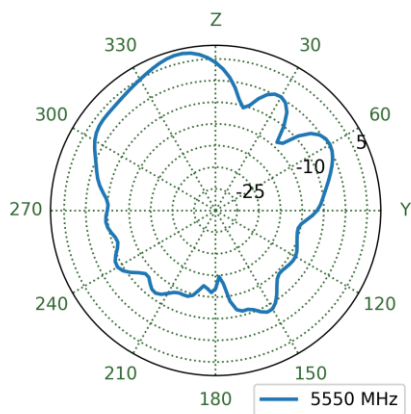
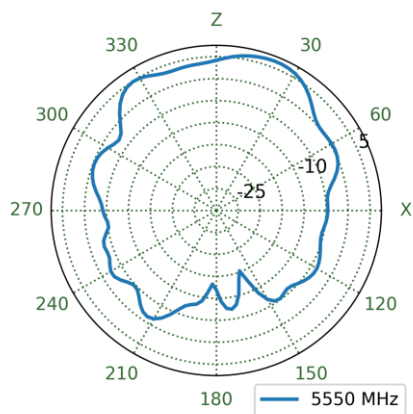

7.25 Metal Box_Port3 Patterns at 5550MHz

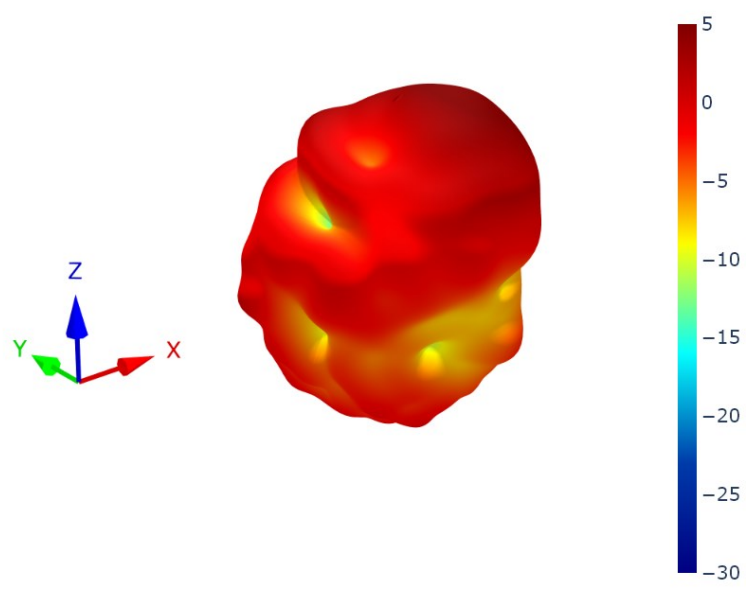

XZ Plane YZ Plane XY Plane

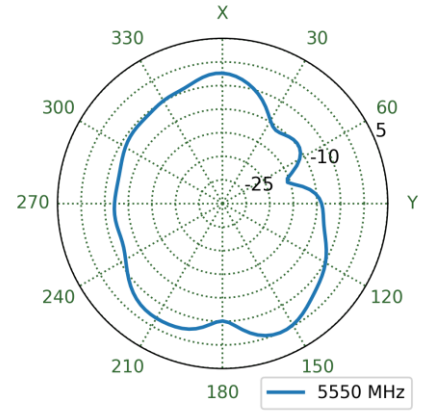
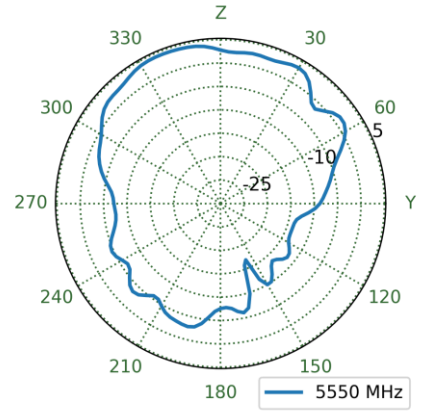
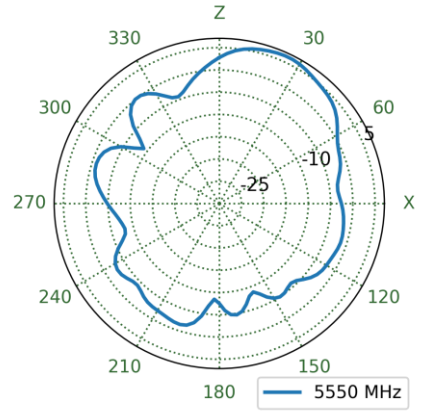

7.26 Metal Box_Port1 Patterns at 6525MHz

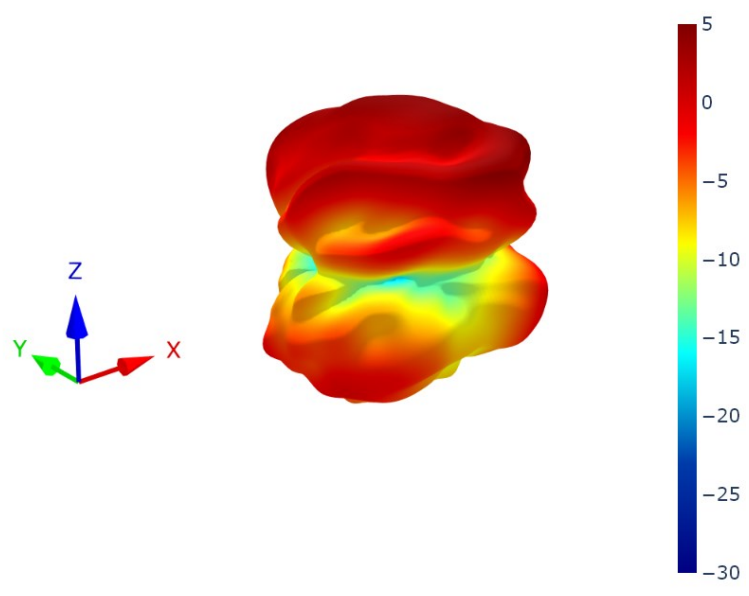

XZ Plane YZ Plane XY Plane

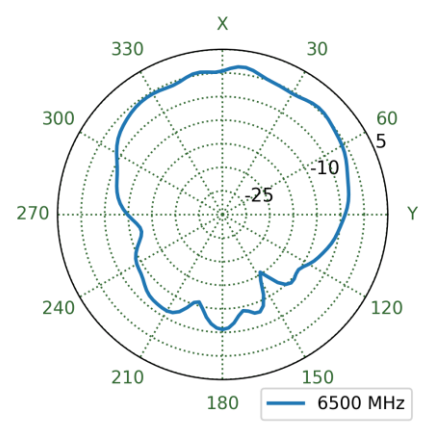
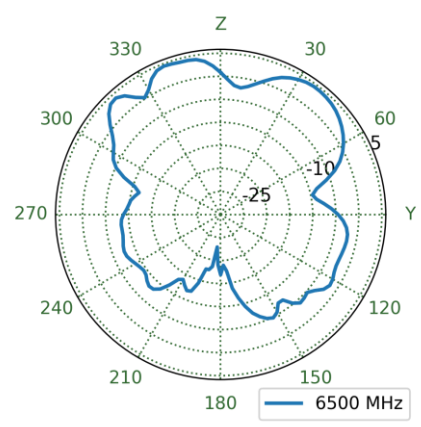
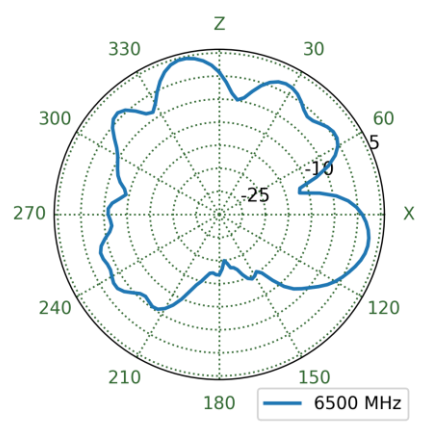

7.27 Metal Box_Port2 Patterns at 6525MHz

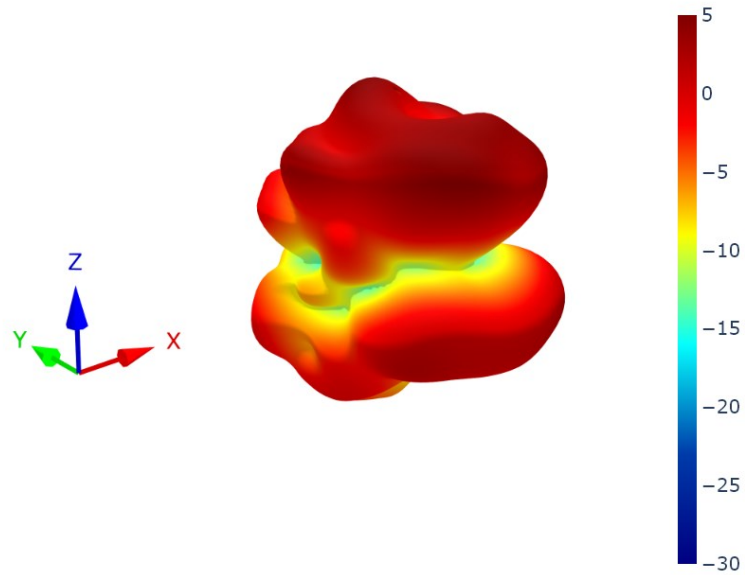

XZ Plane YZ Plane XY Plane

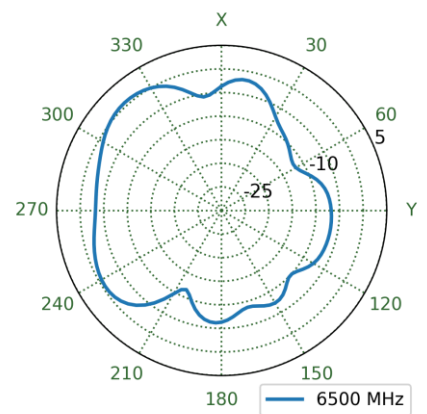
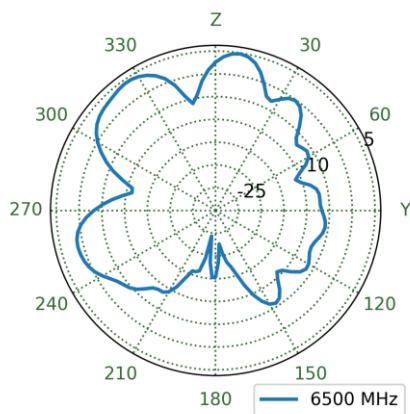
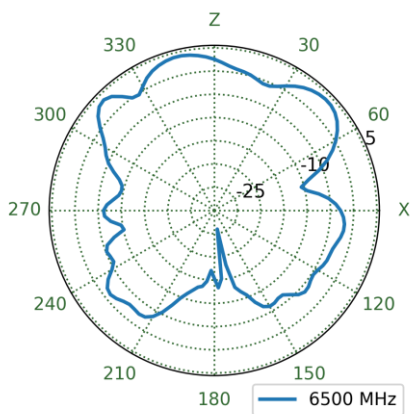

7.28 Metal Box_Port3 Patterns at 6525MHz

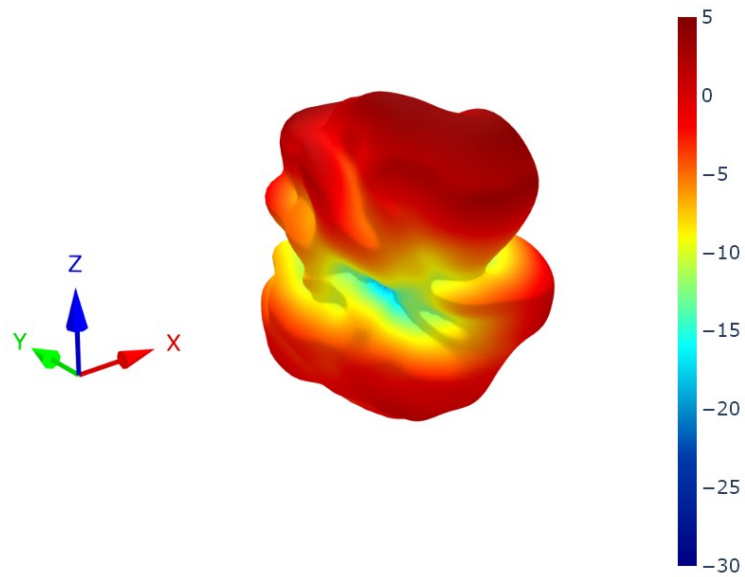

XZ Plane YZ Plane XY Plane

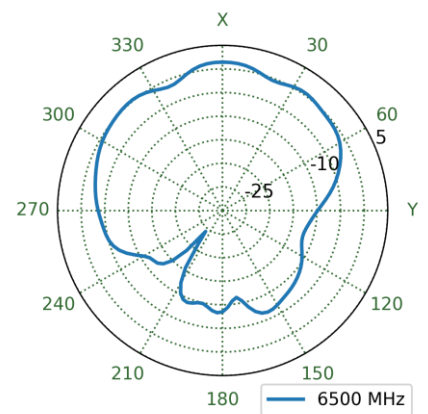
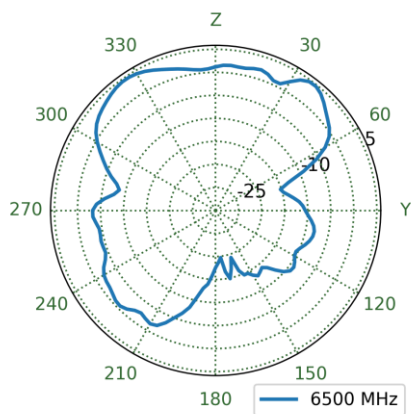
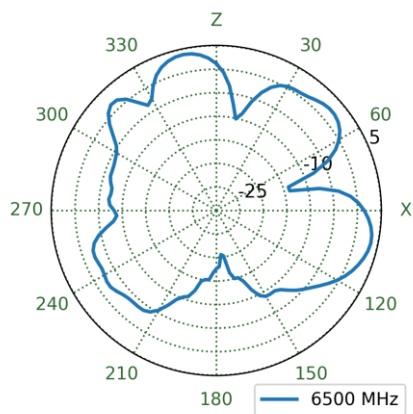

8. Application Note

This application note shows the performance of the TU.66.3H31, In Free Space on a 9x15cm Ground plane and on a 15x9cm Ground Plane.

LTE Electrical									
Band	Frequency (MHz)	Measurement	Efficiency (%)	Average Gain (dB)	Peak Gain (dBi)	Impedance	Polarization	Radiation Pattern	Max. input power
5G NR/4G Band 71	617-698	15x9cm Ground Plane	62.9	-2.01	1.47	50 Ω	Linear	Omni	50W
		9x15cm Ground Plane	54.1	-2.67	1.76				
		Free Space	19.5	-7.10	-1.33				
4G/3G Band 12,13,14,17,28,29	698-824	15x9cm Ground Plane	70.6	-1.51	2.89				
		9x15cm Ground Plane	62.1	-2.07	2.87				
		Free Space	30.6	-5.15	1.43				
4G/3G/NB-IoT/Cat M Band 5,8,18,19,20,26,27	824-960	15x9cm Ground Plane	76.5	-1.17	2.96				
		9x15cm Ground Plane	66.3	-1.78	3.08				
		Free Space	29.6	-5.29	1.00				
5G NR/4G Band 21,32,74,75,76	1427-1518	15x9cm Ground Plane	82.7	-0.82	5.28				
		9x15cm Ground Plane	77.2	-1.13	5.55				
		Free Space	59.1	-2.29	2.55				
4G/3G Band 1,2,3,4,9,23,25,35,39,66	1710-2200	15x9cm Ground Plane	74.6	-1.27	4.28				
		9x15cm Ground Plane	79.9	-0.97	5.20				
		Free Space	52.6	-2.79	0.57				
4G/3G Band 7,30,38,40,41	2300-2690	15x9cm Ground Plane	59.0	-2.29	6.06				
		9x15cm Ground Plane	58.6	-2.32	4.84				
		Free Space	53.3	-2.73	2.09				
5G NR/4G Band 22,42,48,77,78,79	3300-5000	15x9cm Ground Plane	64.9	-1.87	4.43				
		9x15cm Ground Plane	67.7	-1.69	5.09				
		Free Space	75.7	-1.21	4.65				
LTE5200/Wi-Fi5800	5150-5925	15x9cm Ground Plane	63.2	-1.99	4.92				
		9x15cm Ground Plane	68.4	-1.65	5.01				
		Free Space	83.4	-0.79	5.25				
WiFi - 6GHz	5925-7125	15x9cm Ground Plane	64.7	-1.89	4.87				
		9x15cm Ground Plane	73.0	-1.37	4.95				
		Free Space	79.2	-1.01	5.68				

9. Antenna Characteristics

9.1 Test Setup

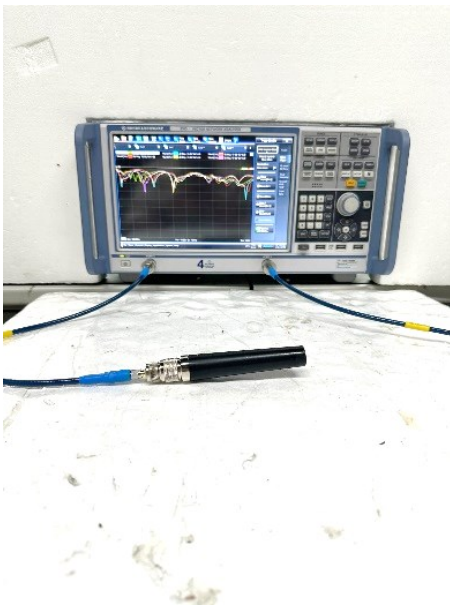
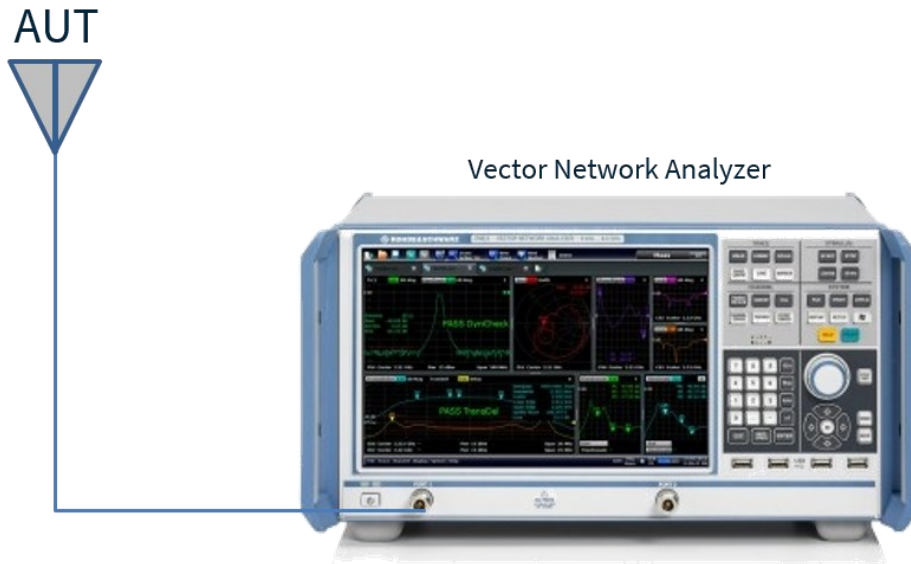

VNA Test Set-up – In Free Space

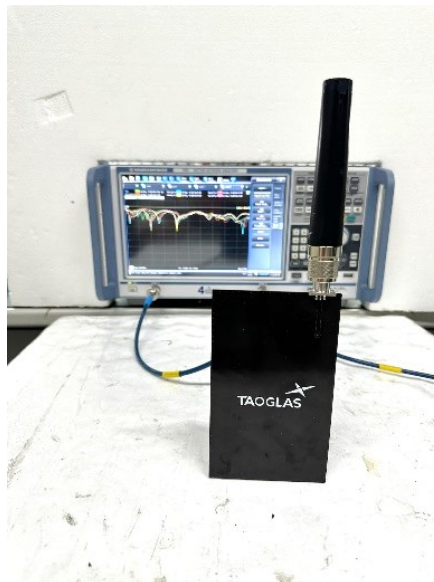

VNA Test Set-up – 9x15cm Ground Plane



VNA Test Set-up – 15x9cm Ground Plane

9.2 Return Loss

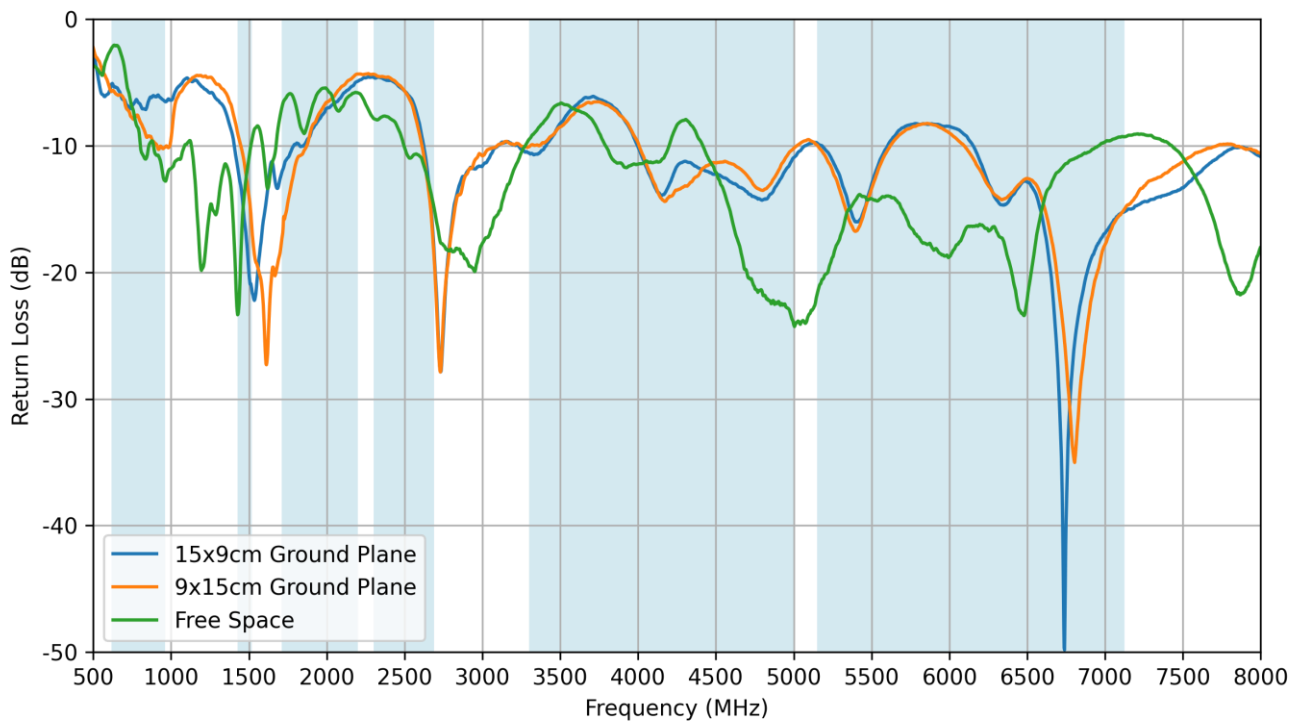

9.3 VSWR

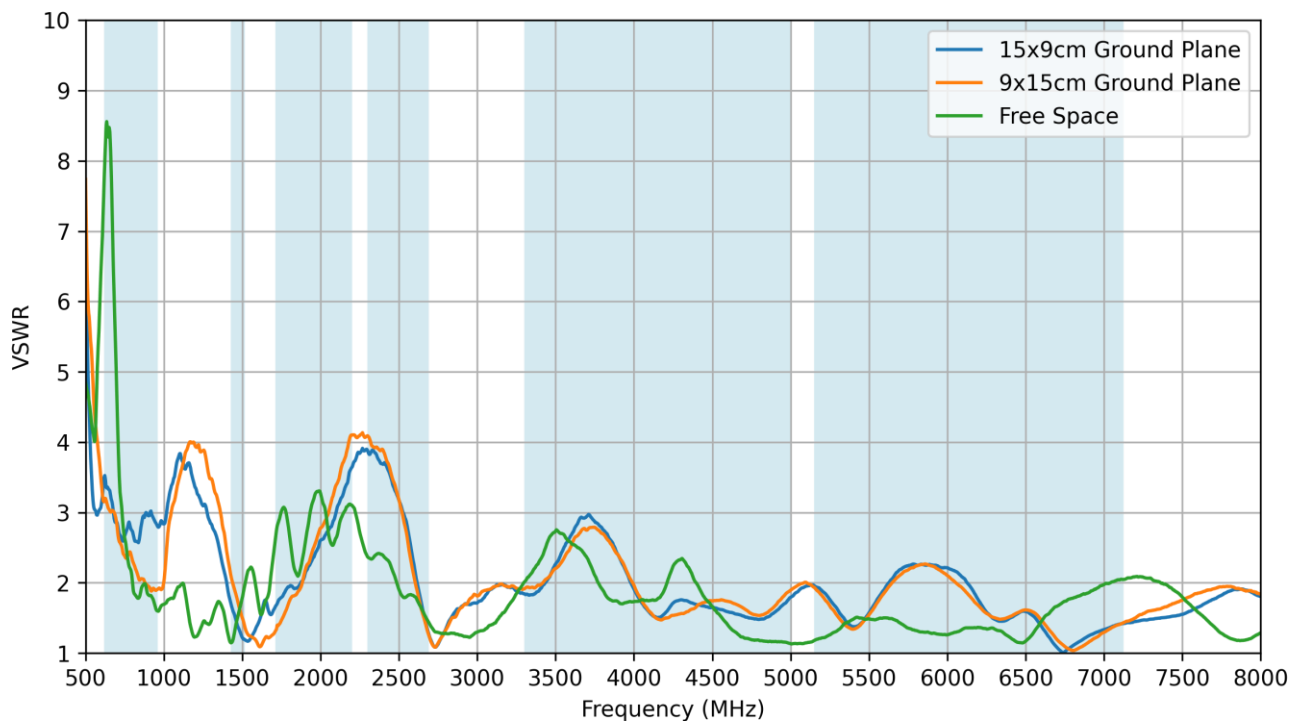

9.4 Efficiency

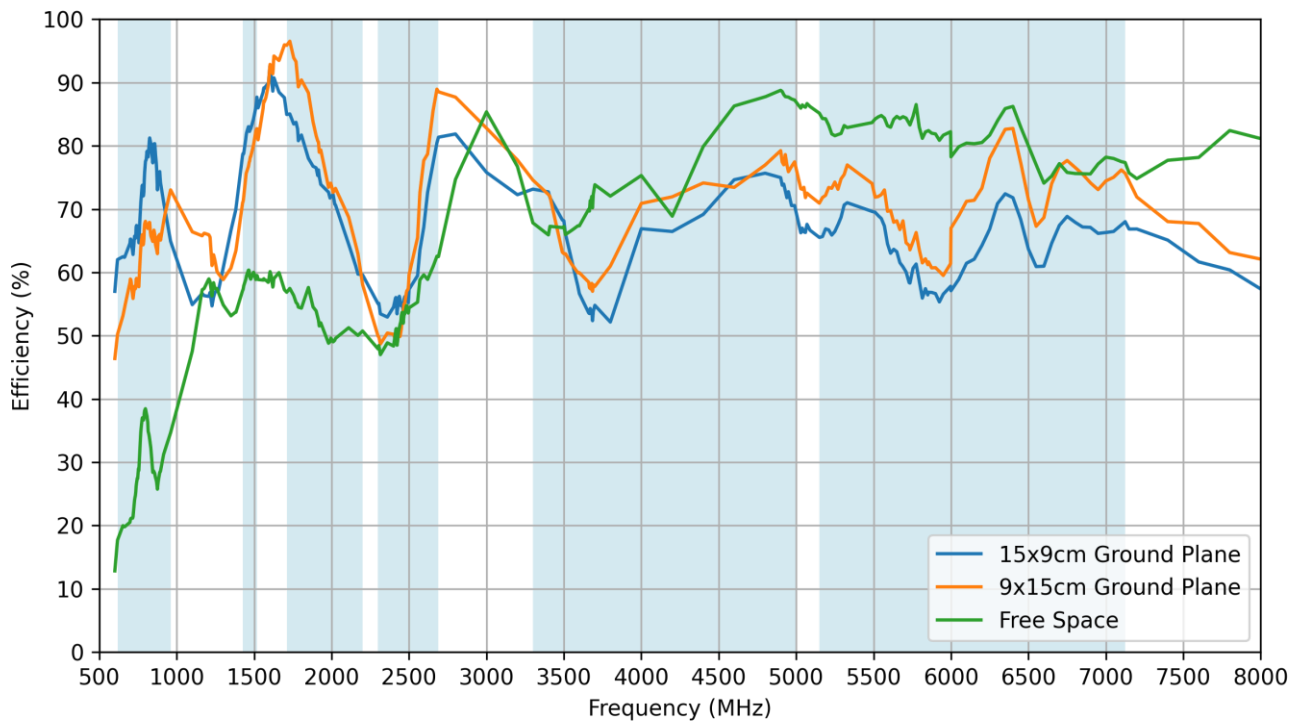

9.5 Average Gain

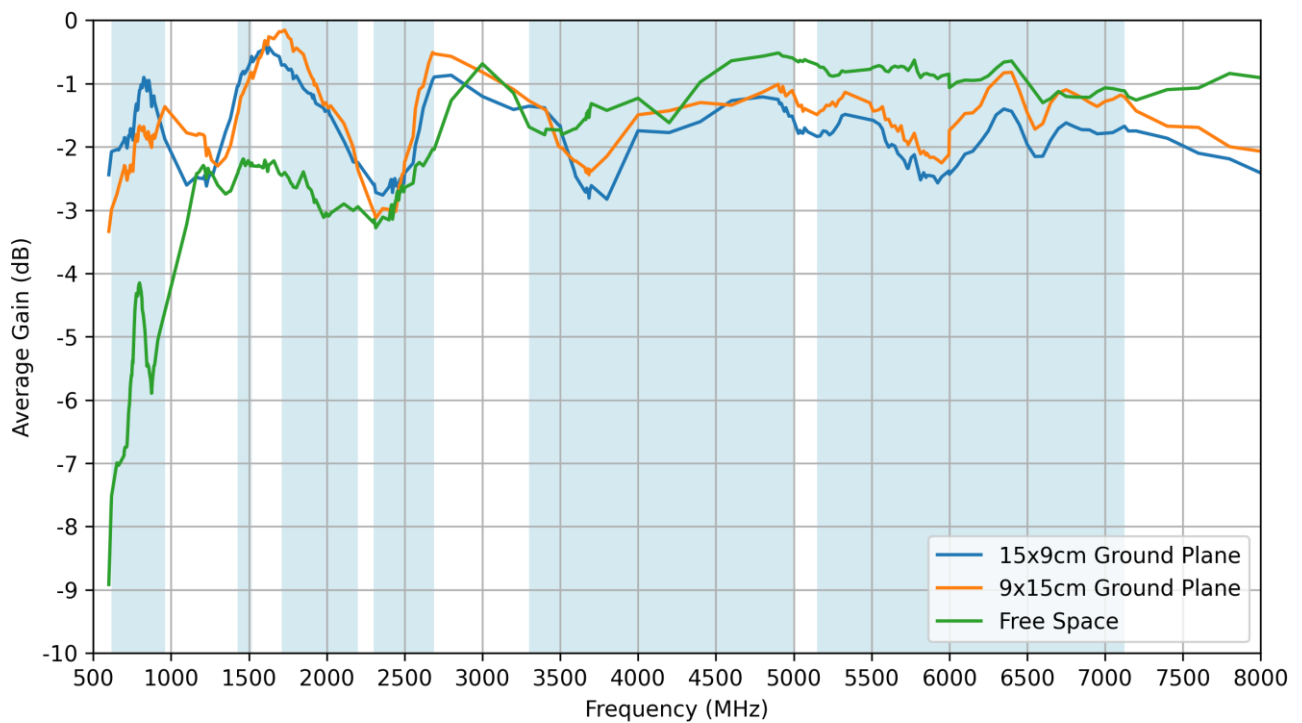

9.6 Peak Gain

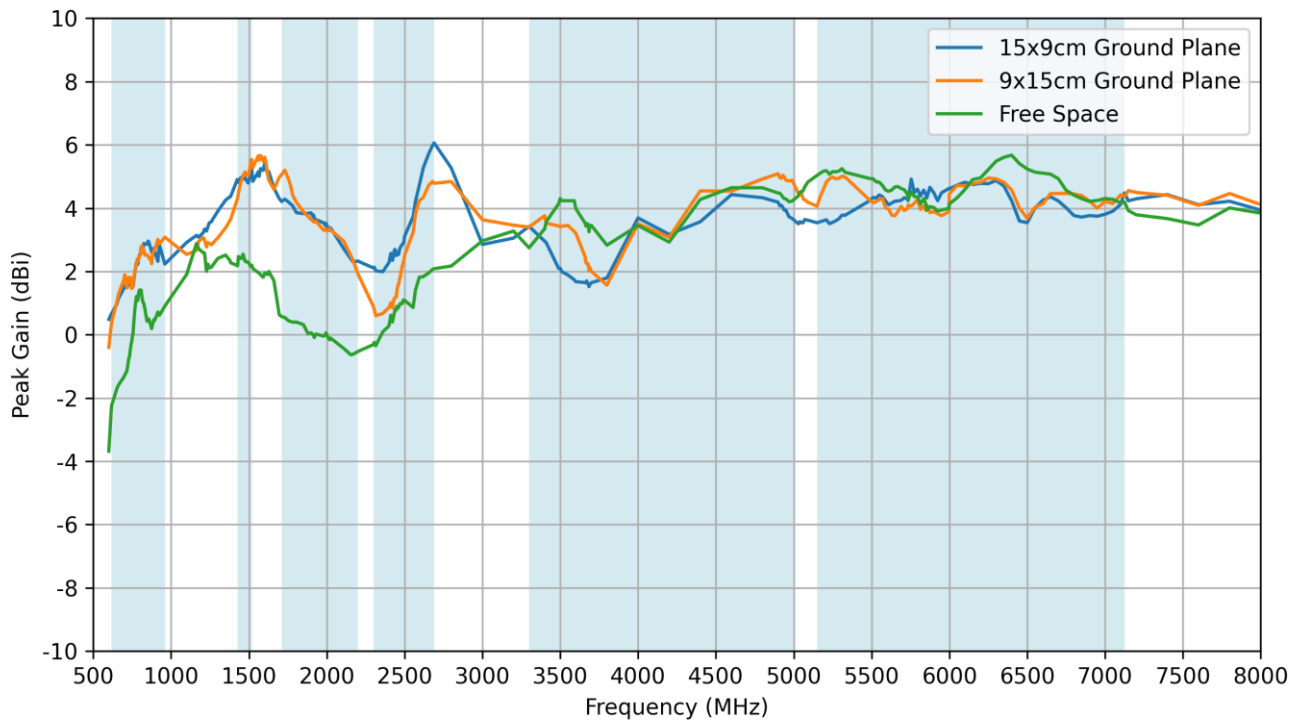

10. Radiation Patterns

10.1 Test Setup

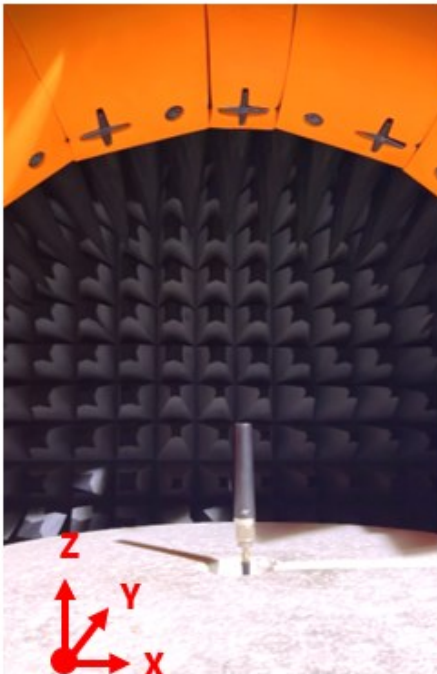
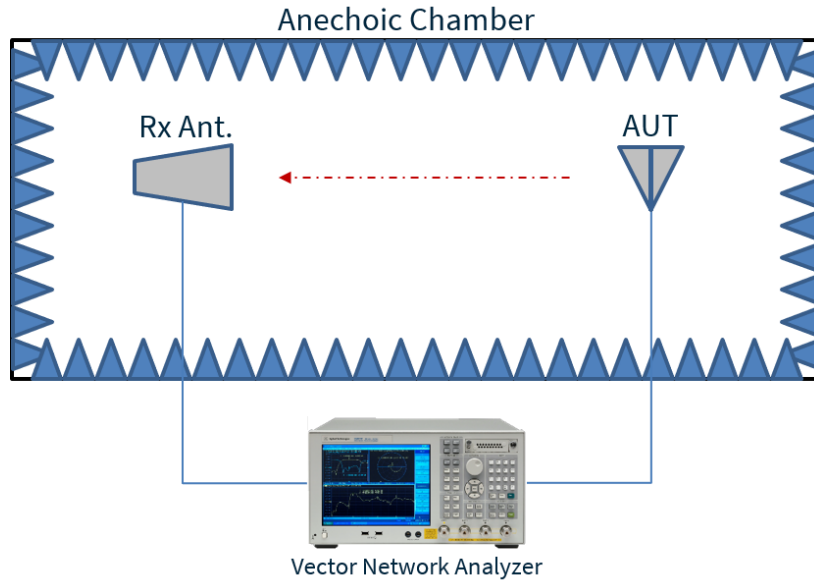

VNA Test Set-up – In Free Space

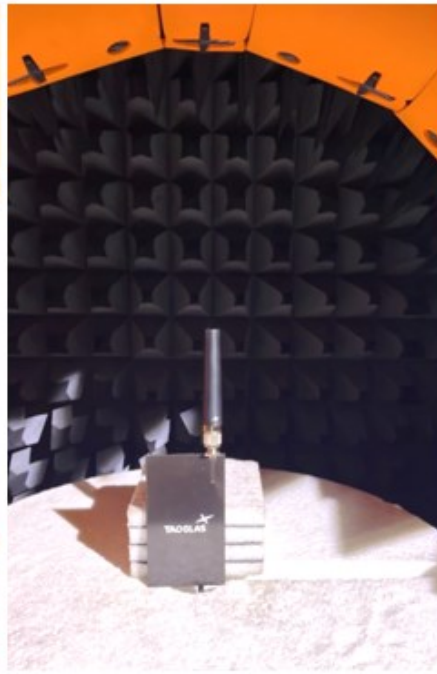

VNA Test Set-up – 9x15cm
Ground Plane

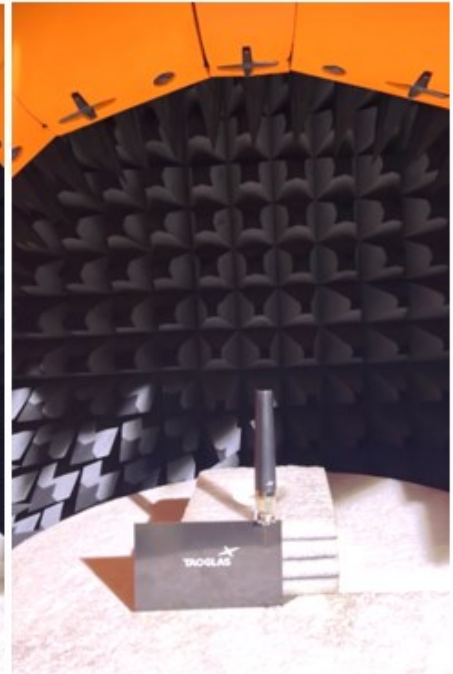

VNA Test Set-up – 15x9cm
Ground Plane

10.2 15x9cm Ground Plane Patterns at 652MHz

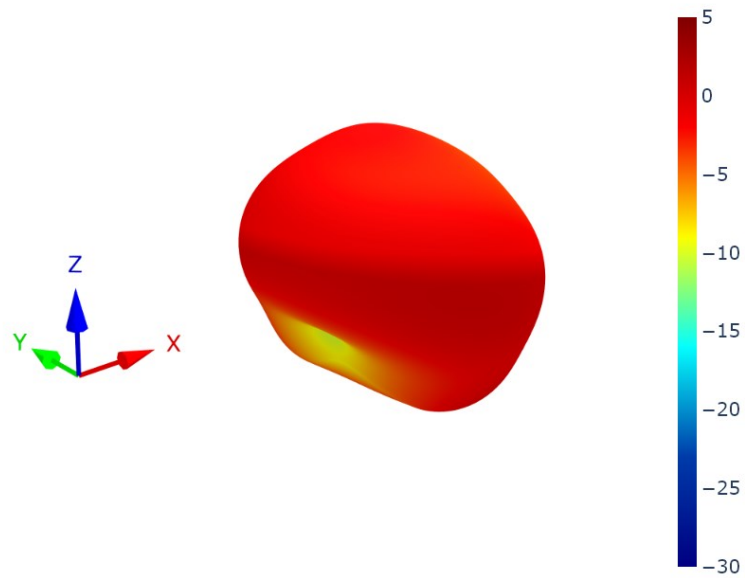

XZ Plane YZ Plane XY Plane

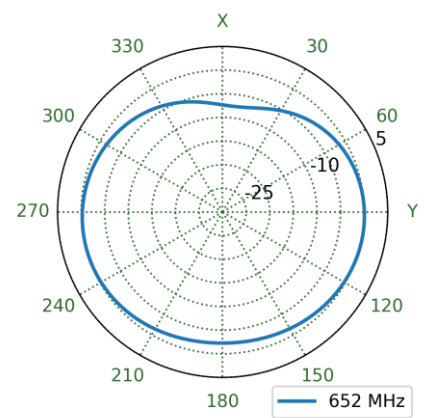
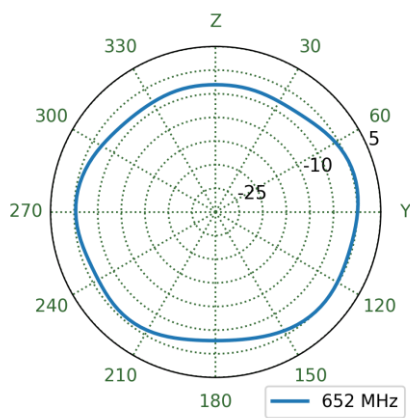
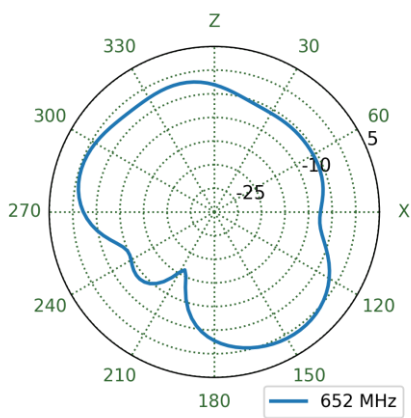

10.3 9x15cm Ground Plane Patterns at 652MHz

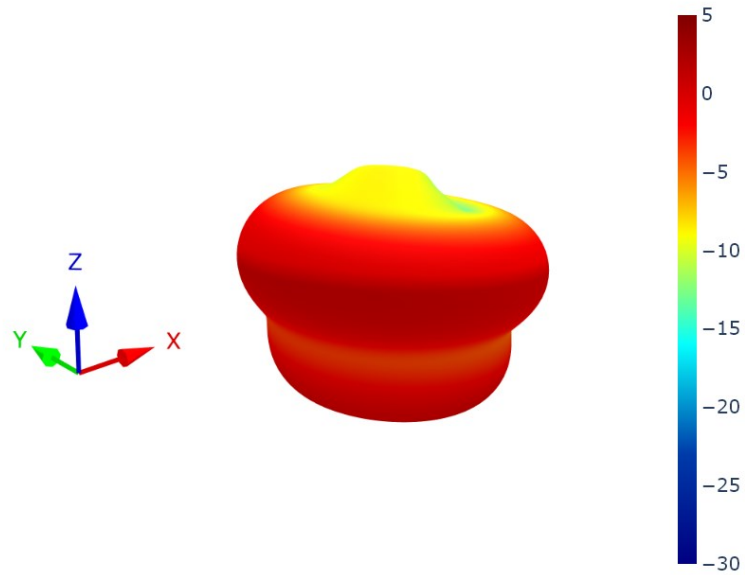

XZ Plane YZ Plane XY Plane

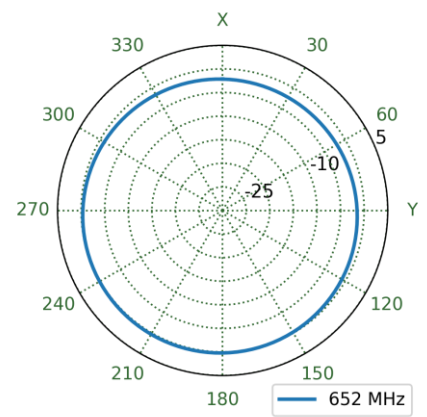
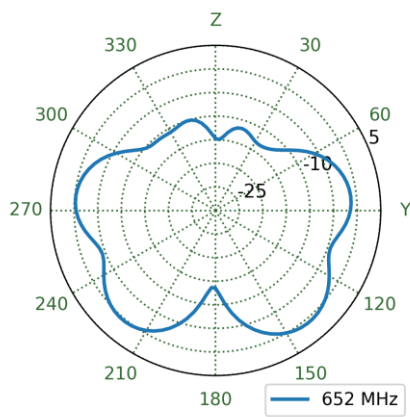
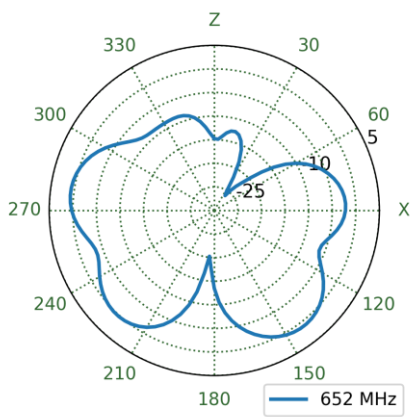

10.4 Free Space Patterns at 652MHz

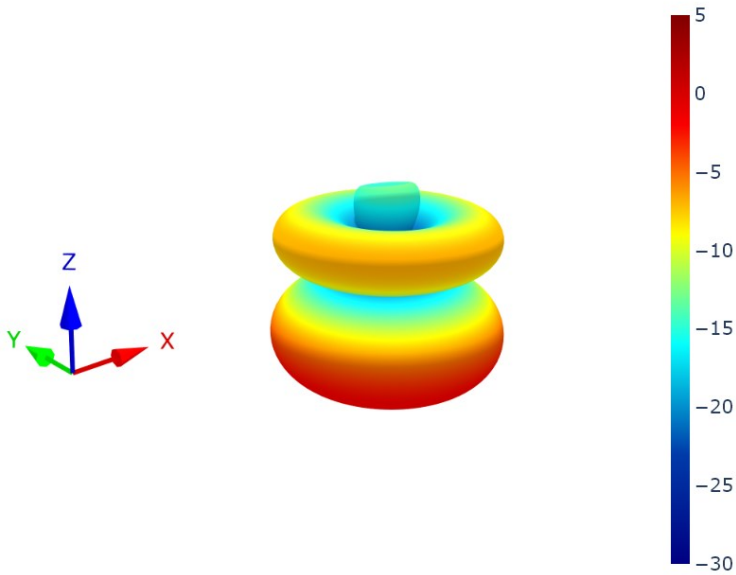

XZ Plane YZ Plane XY Plane

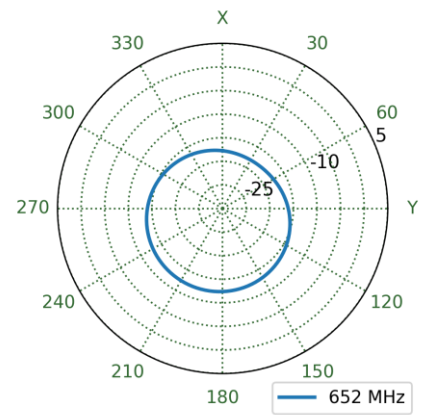
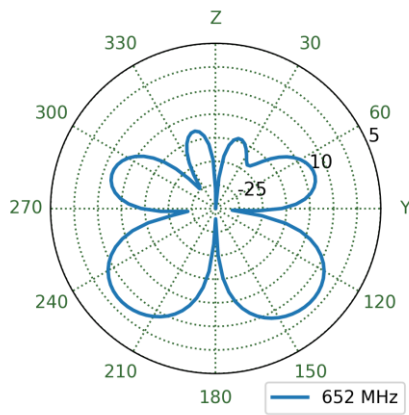
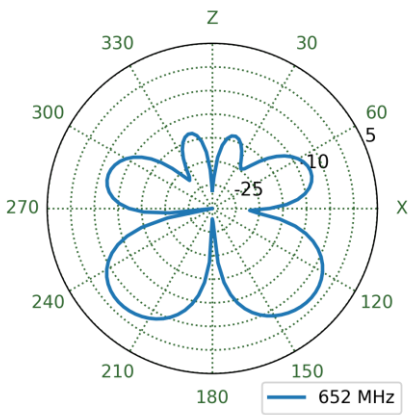

10.5 15x9cm Ground Plane Patterns at 751MHz

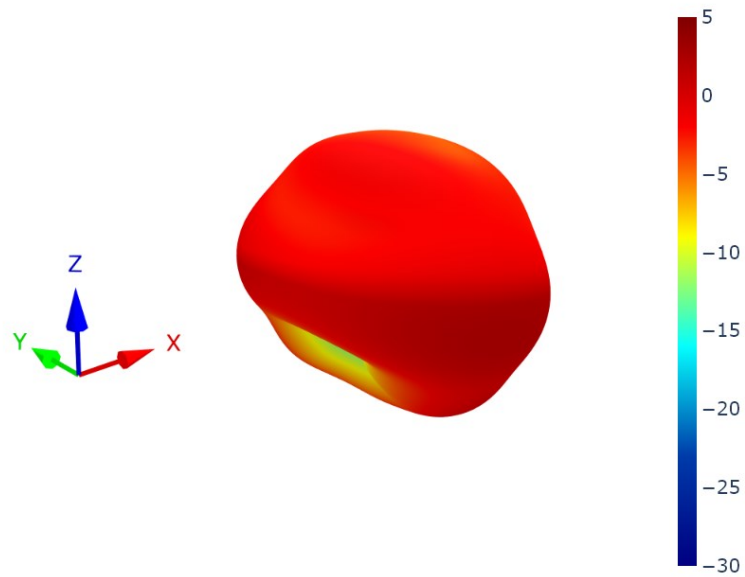

XZ Plane YZ Plane XY Plane

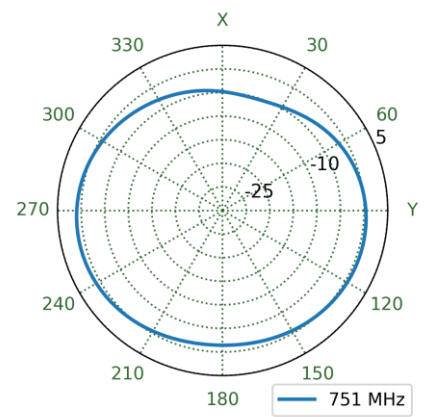
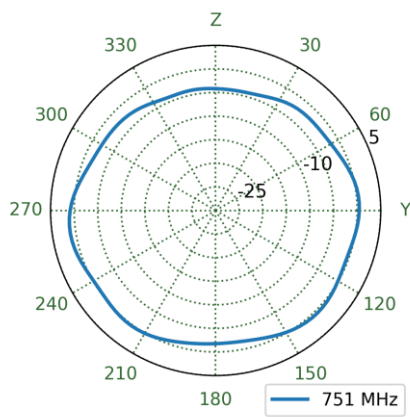
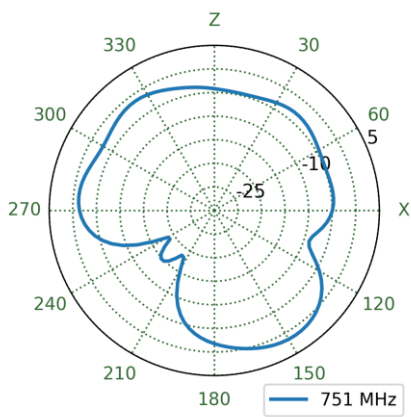

10.7 Free Space Patterns at 751MHz

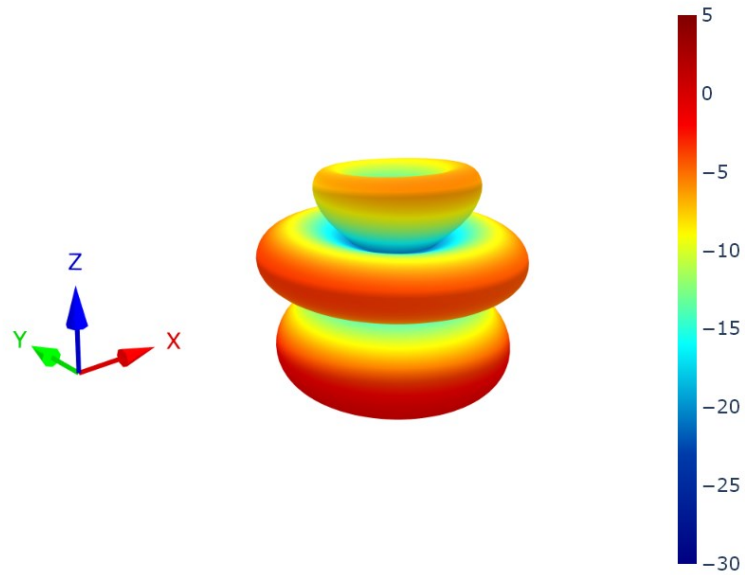

XZ Plane YZ Plane XY Plane

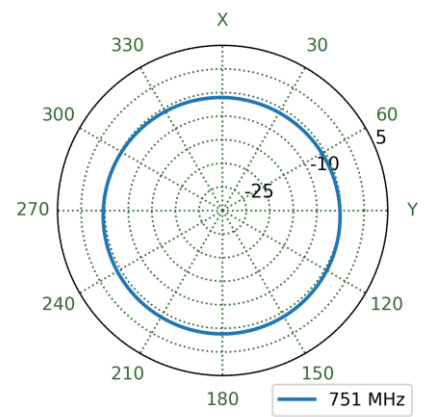
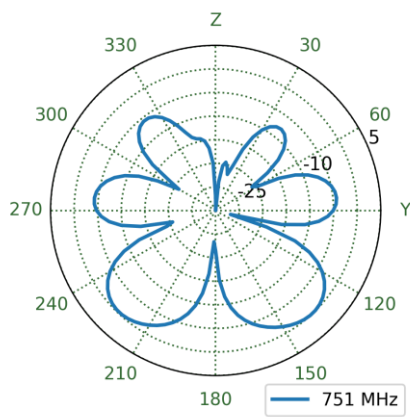
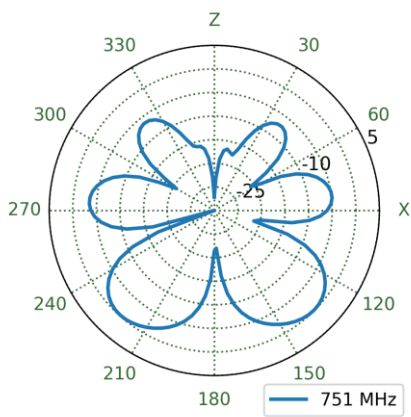

10.8 15x9cm Ground Plane Patterns at 890MHz

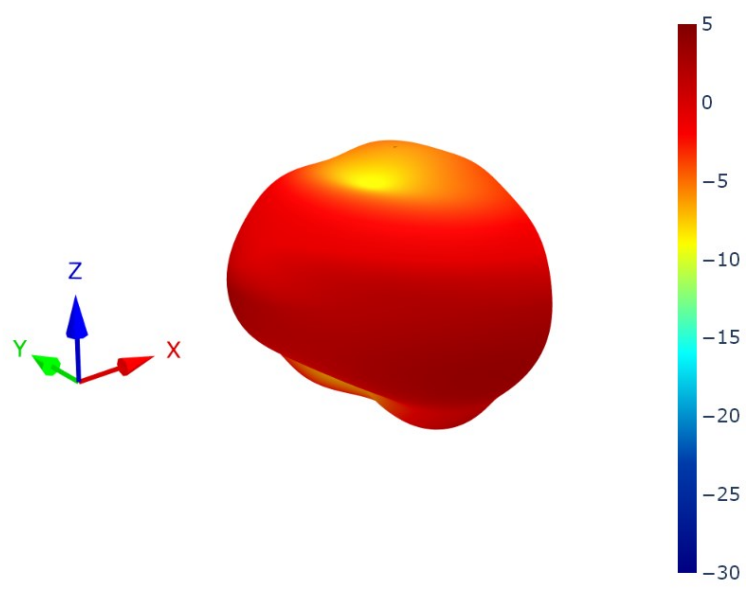

XZ Plane YZ Plane XY Plane

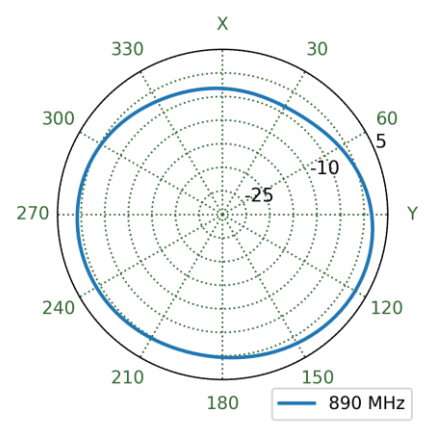
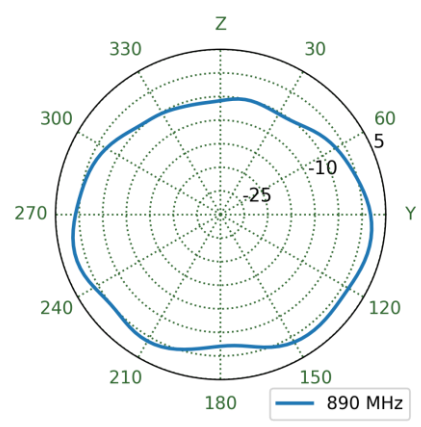
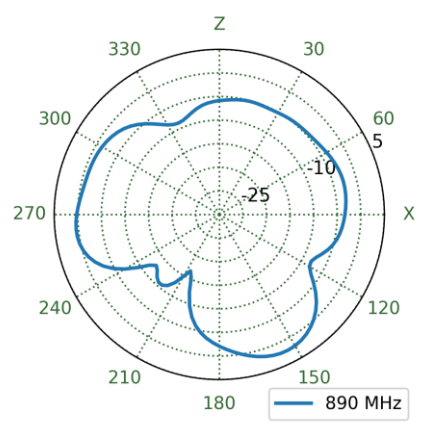

10.10 Free Space Patterns at 890MHz

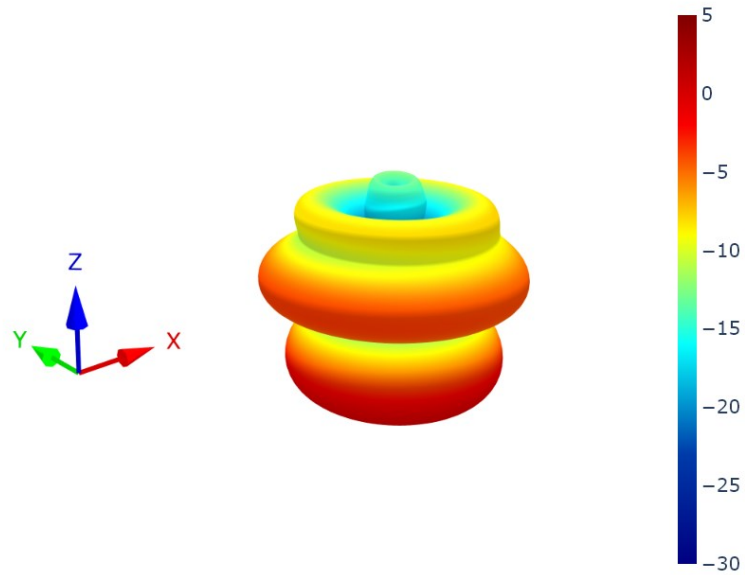

XZ Plane YZ Plane XY Plane

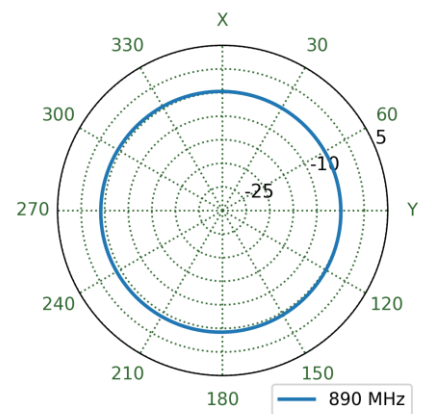
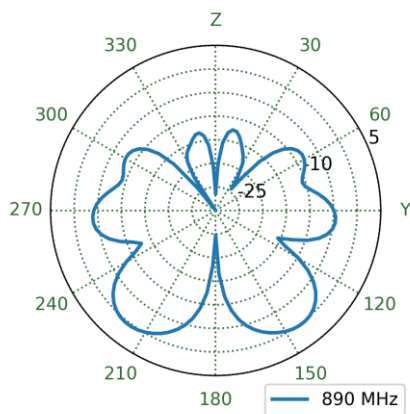
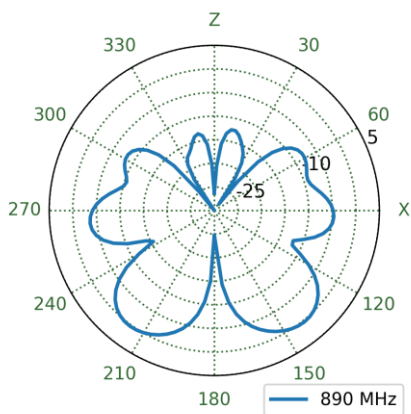

10.11 15x9cm Ground Plane Patterns at 1475MHz

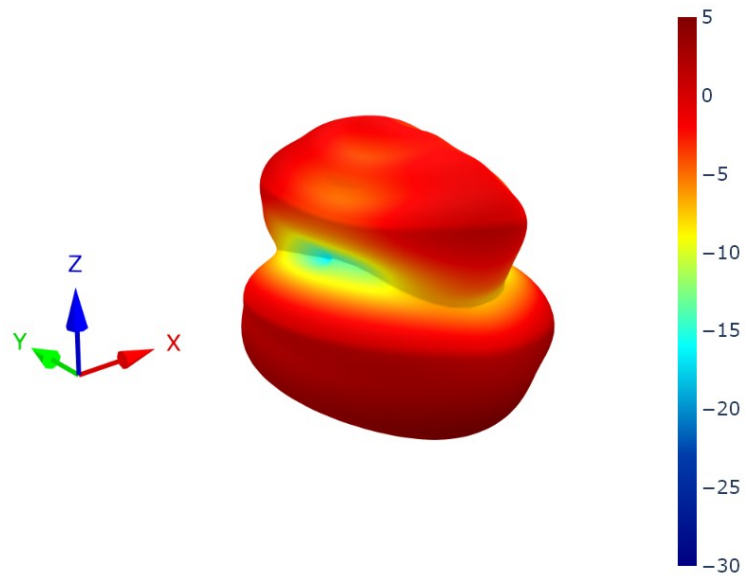

XZ Plane YZ Plane XY Plane

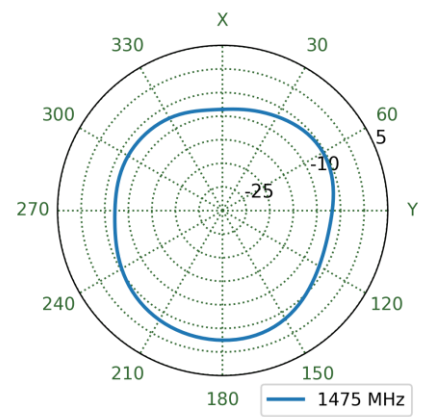
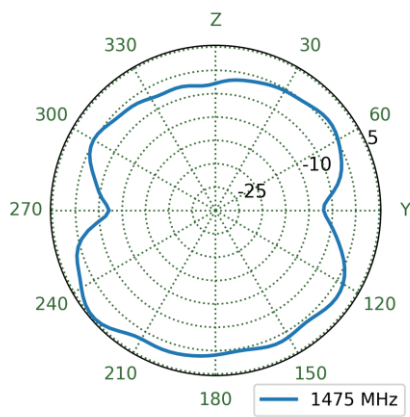
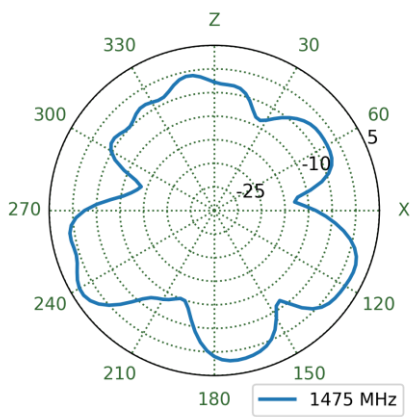

10.12 9x15cm Ground Plane Patterns at 1475MHz

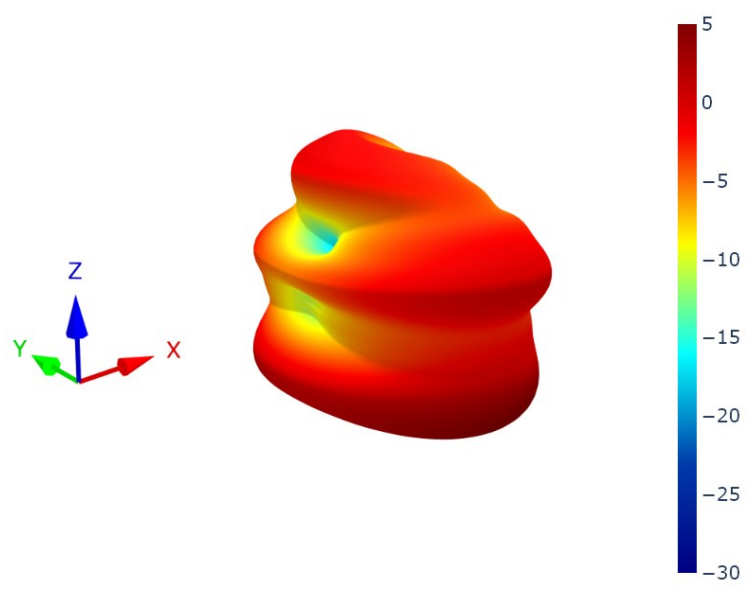

XZ Plane YZ Plane XY Plane

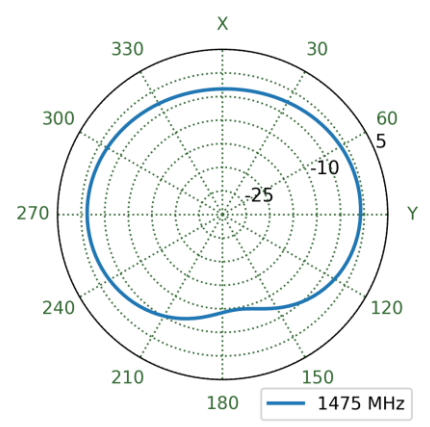
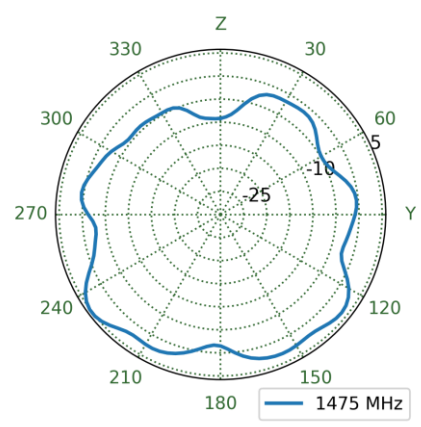
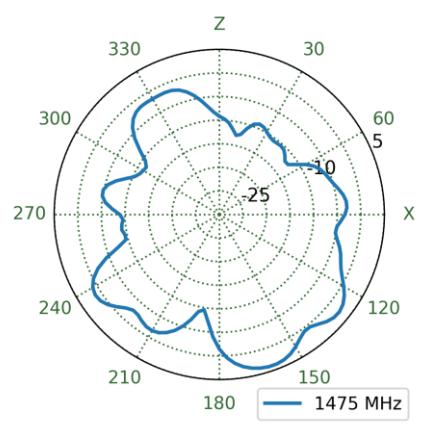

10.13 Free Space Patterns at 1475MHz

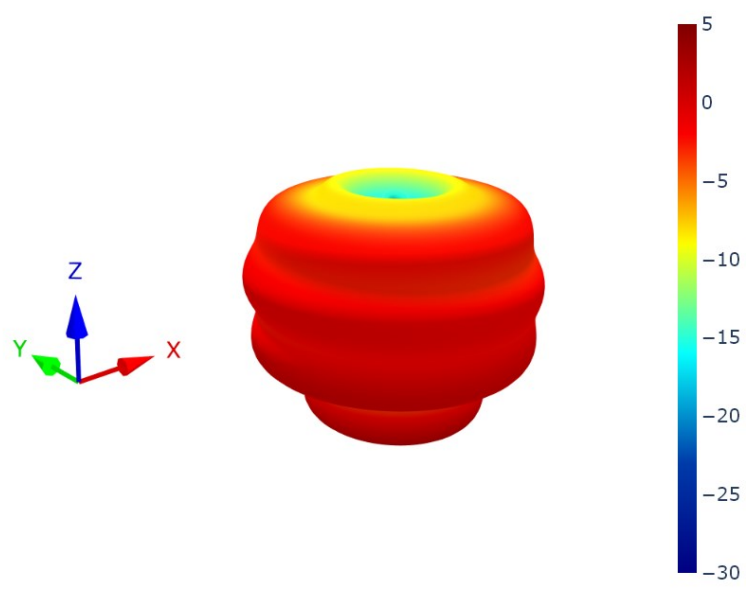

XZ Plane YZ Plane XY Plane

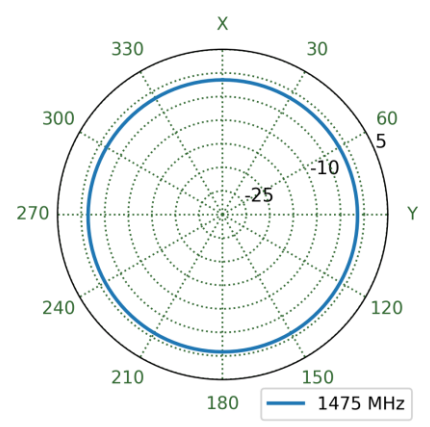
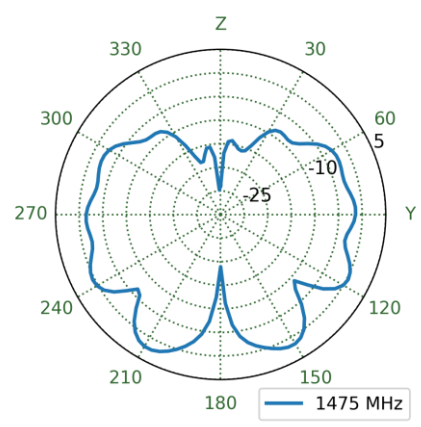
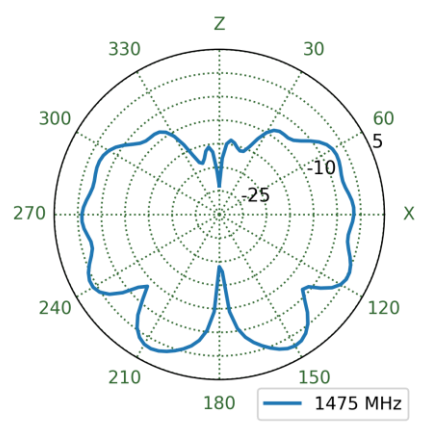

10.14 15x9cm Ground Plane Patterns at 1930MHz

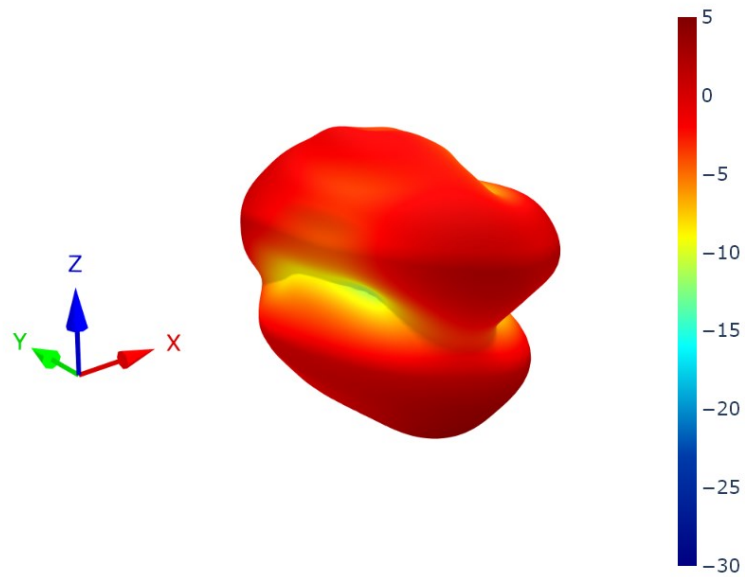

XZ Plane YZ Plane XY Plane

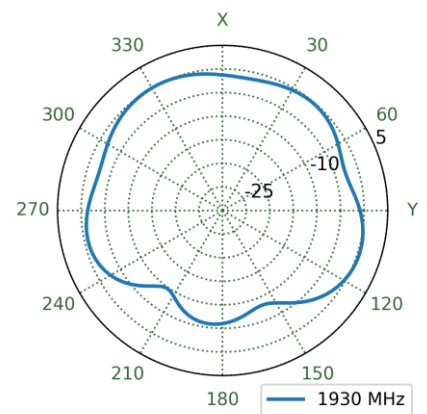
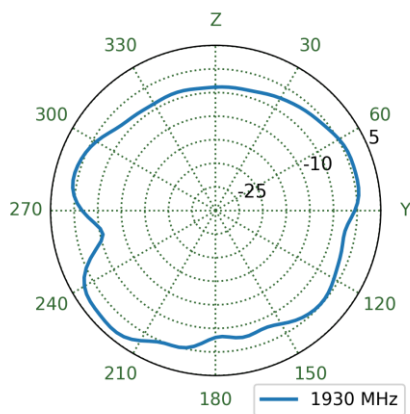
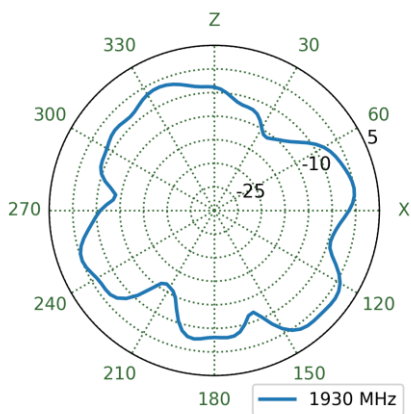

10.15 9x15cm Ground Plane Patterns at 1930MHz

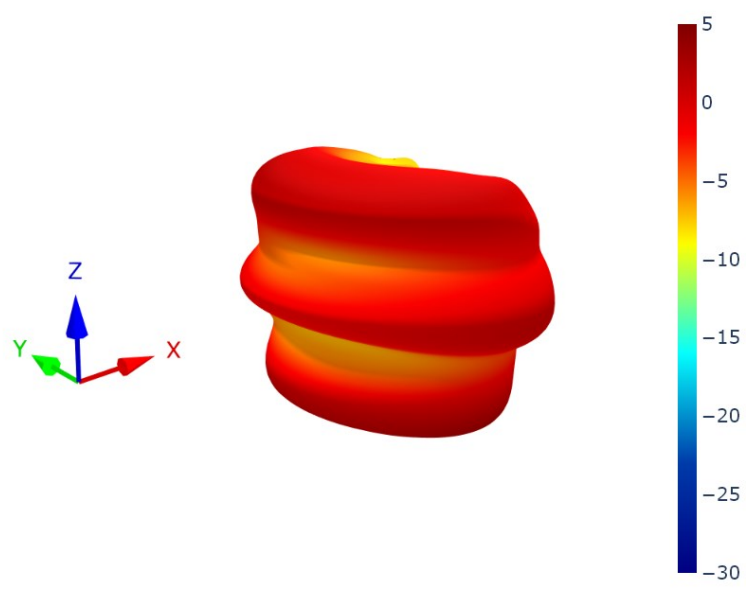

XZ Plane YZ Plane XY Plane

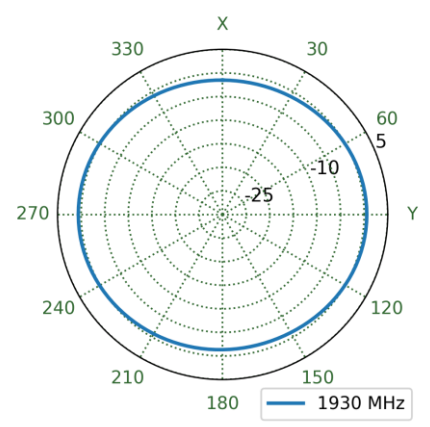
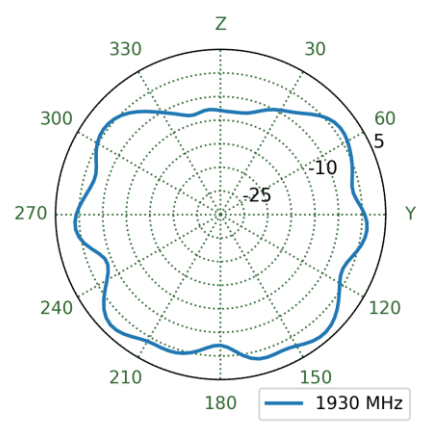
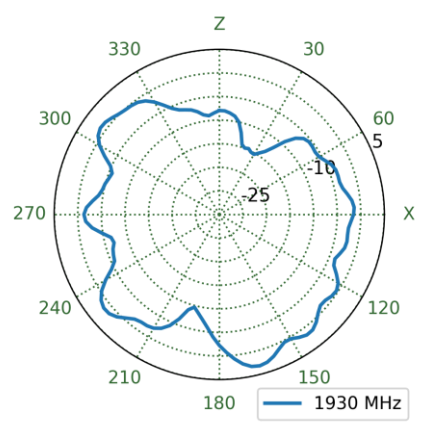

10.16 Free Space Patterns at 1930MHz

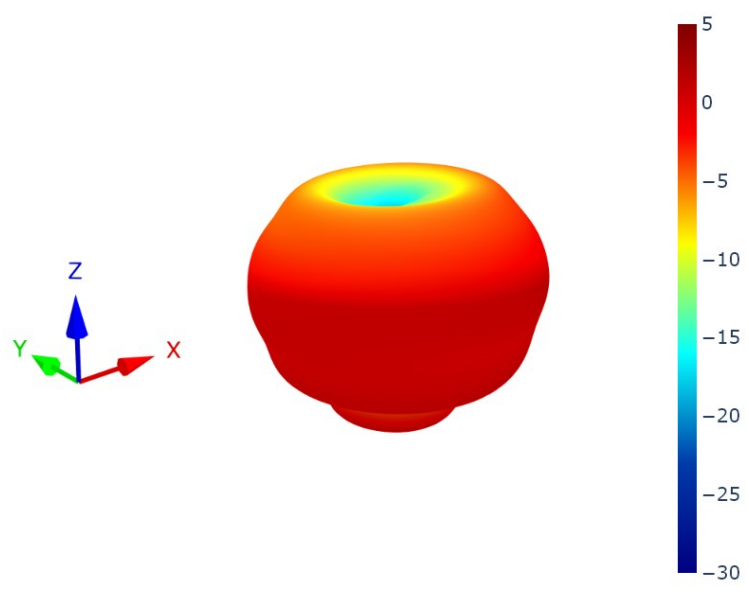

XZ Plane YZ Plane XY Plane

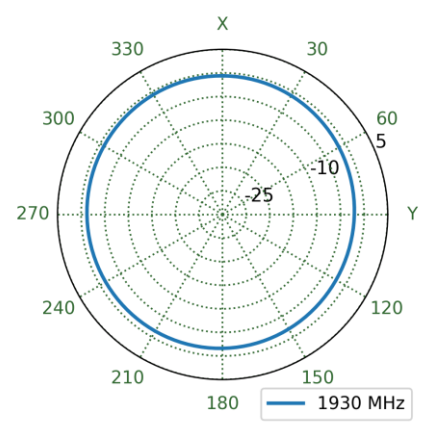
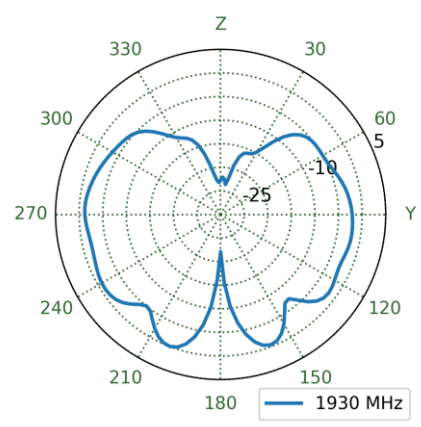
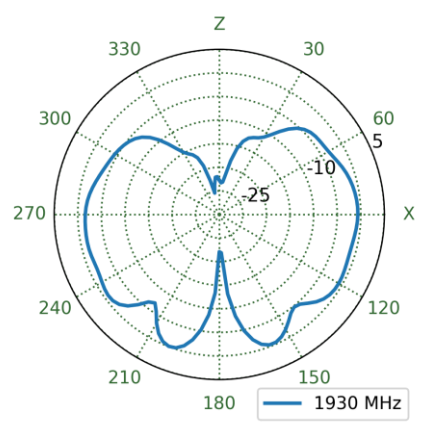

10.17 15x9cm Ground Plane Patterns at 2496MHz

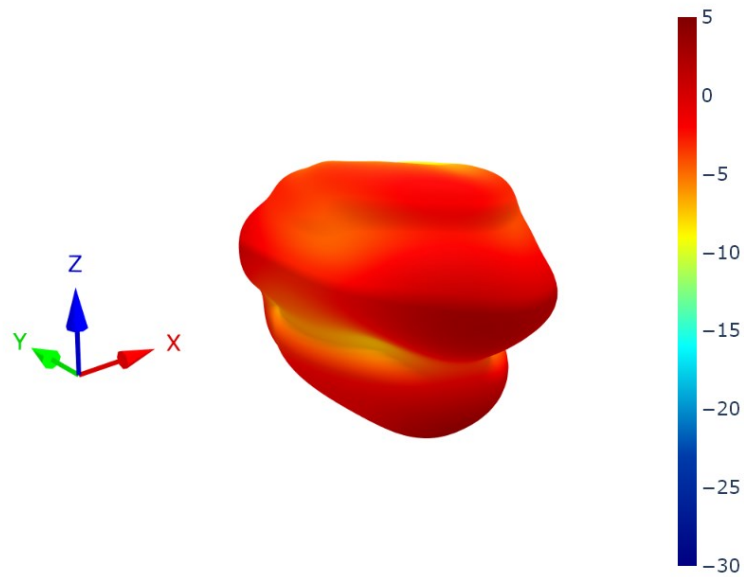

XZ Plane YZ Plane XY Plane

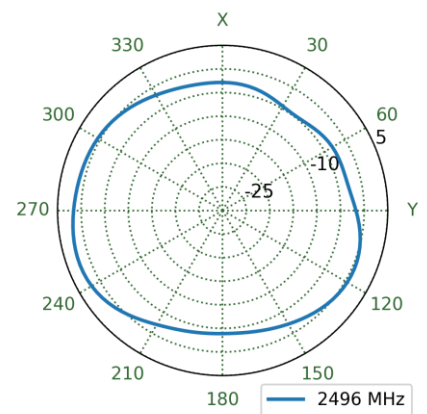
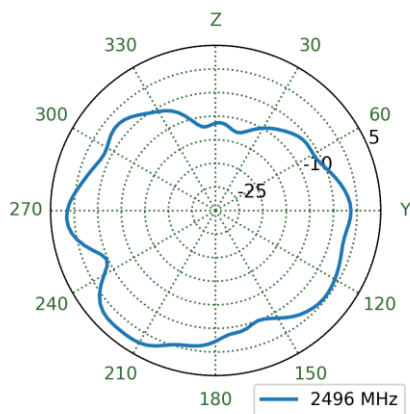
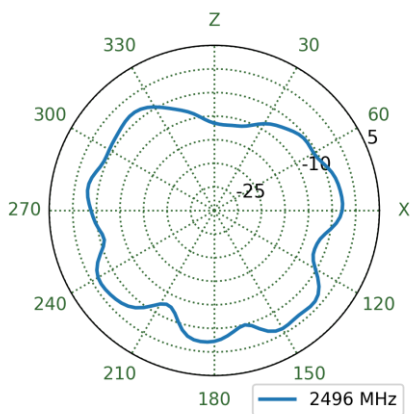

10.18 9x15cm Ground Plane Patterns at 2496MHz

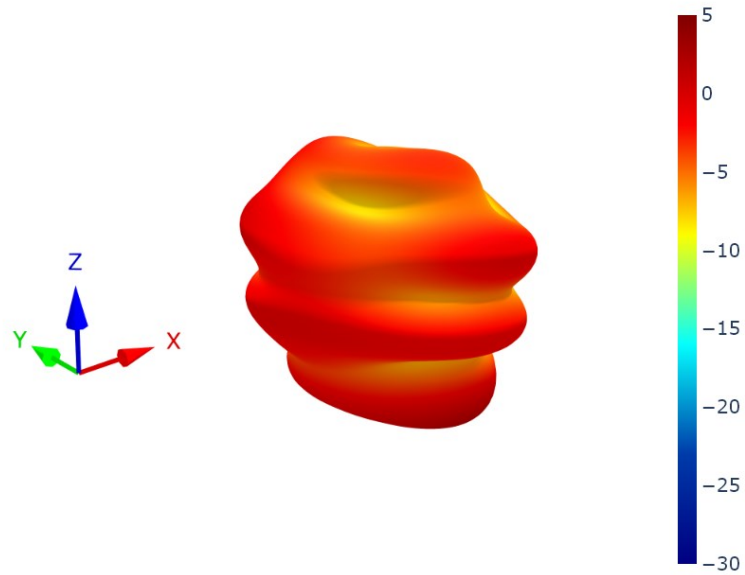

XZ Plane YZ Plane XY Plane

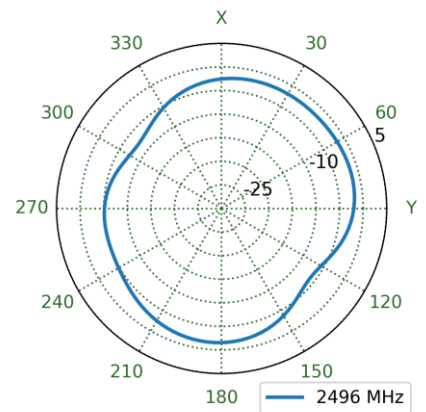
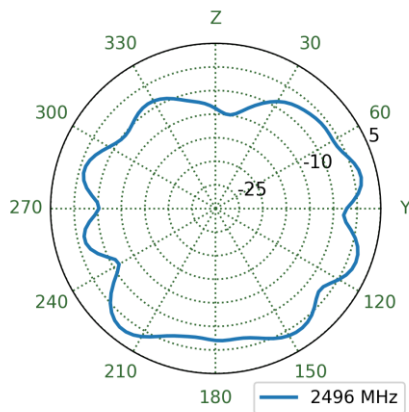
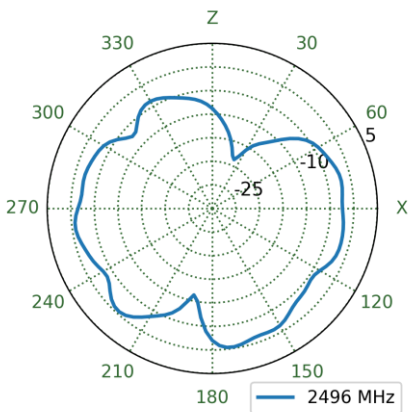

10.19 Free Space Patterns at 2496MHz

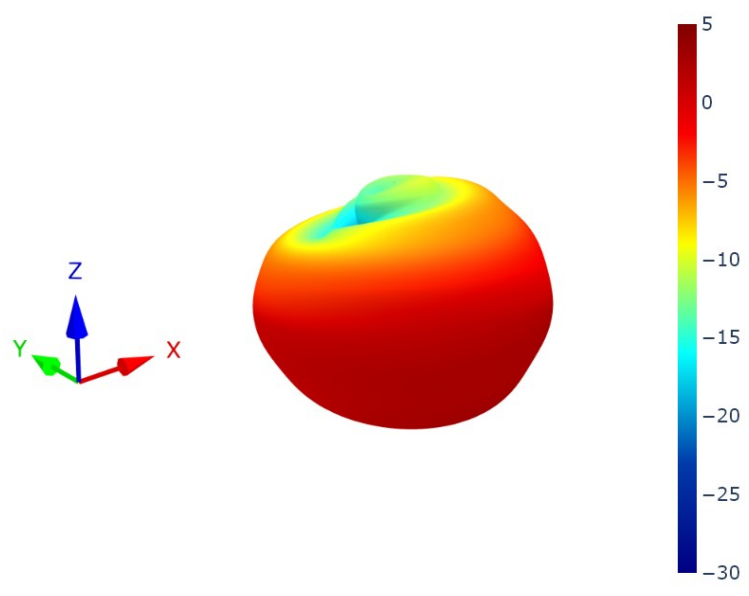

XZ Plane YZ Plane XY Plane

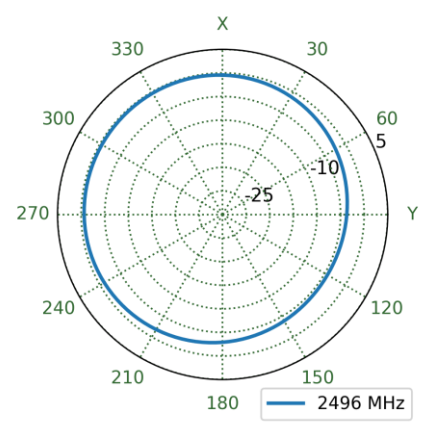
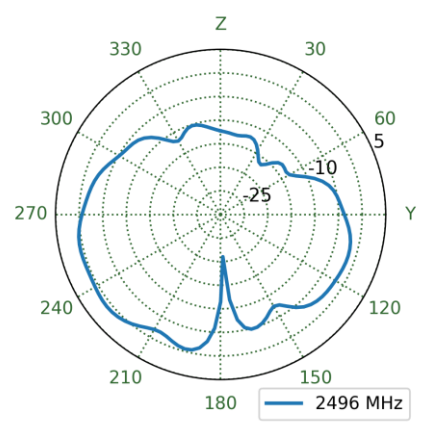
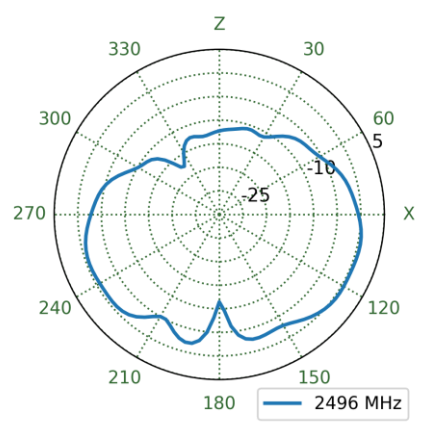

10.20 15x9cm Ground Plane Patterns at 4200MHz

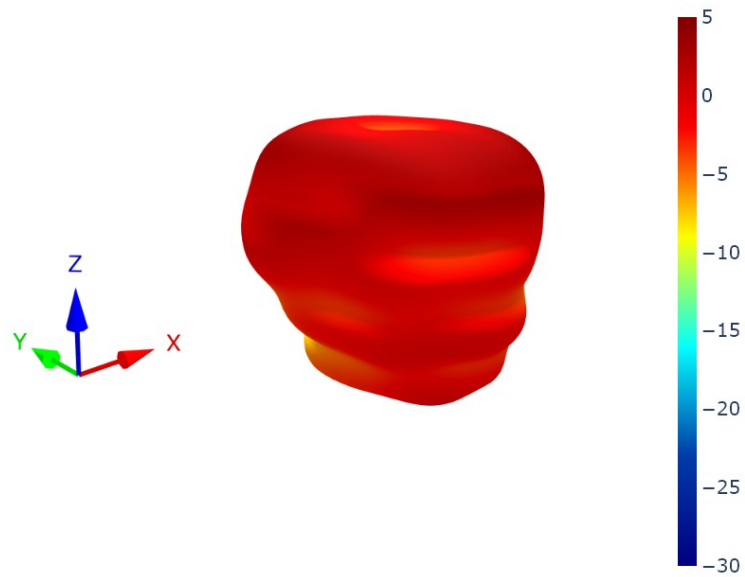

XZ Plane YZ Plane XY Plane

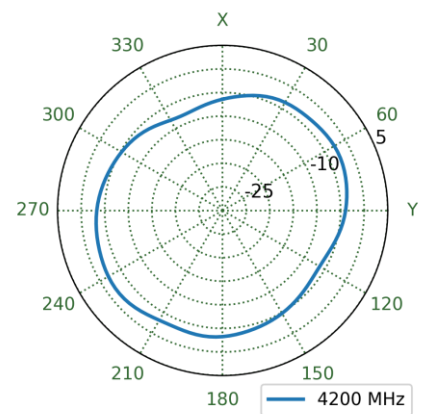
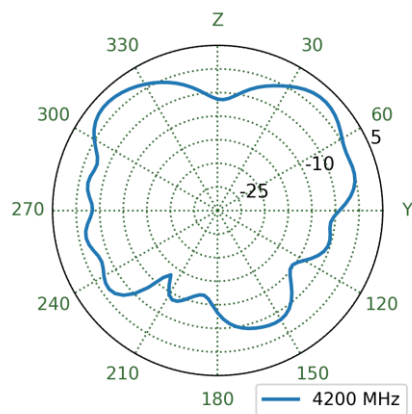
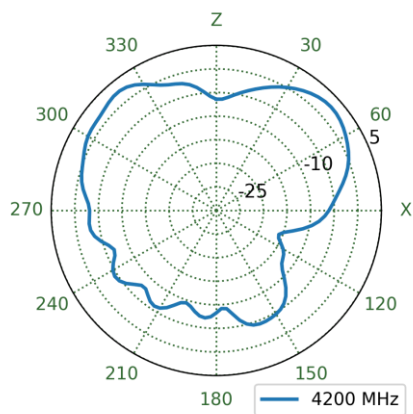

10.21 9x15cm Ground Plane Patterns at 4200MHz

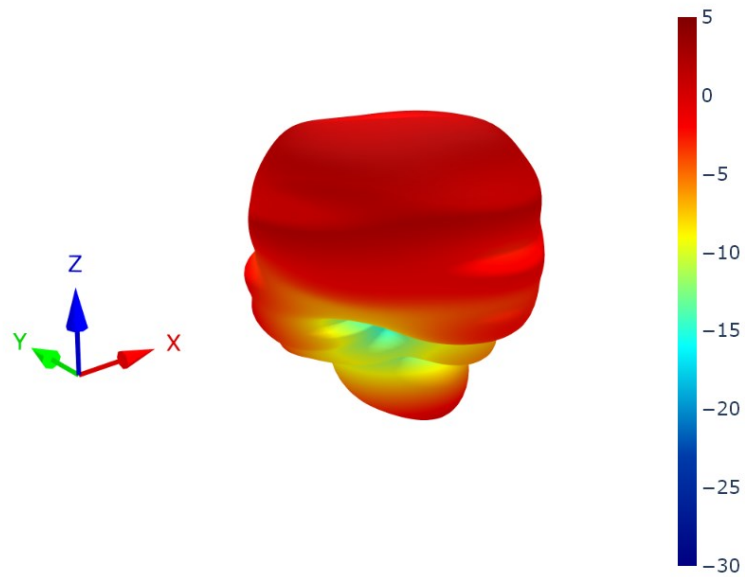

XZ Plane YZ Plane XY Plane

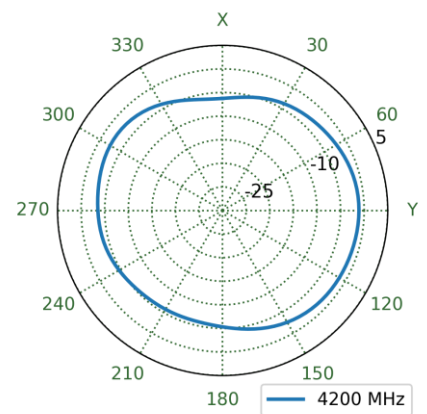
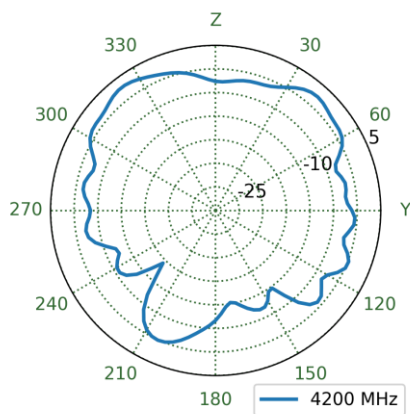
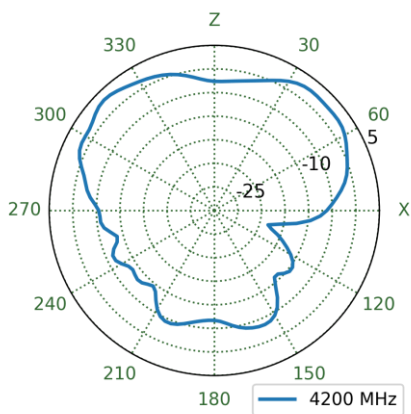

10.22 Free Space Patterns at 4200MHz

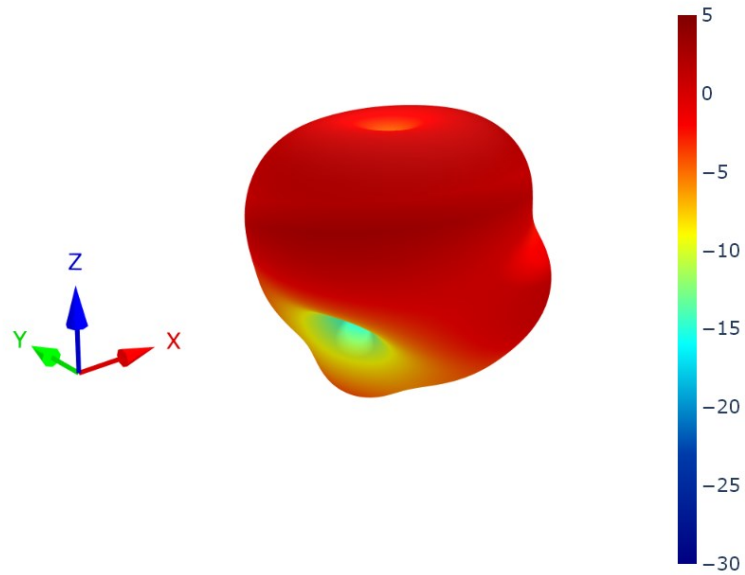

XZ Plane YZ Plane XY Plane

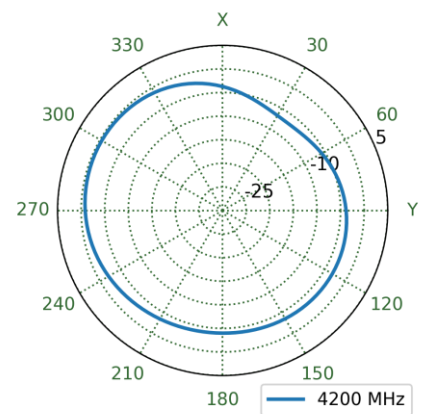
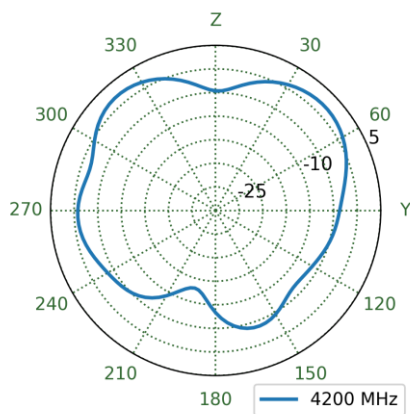
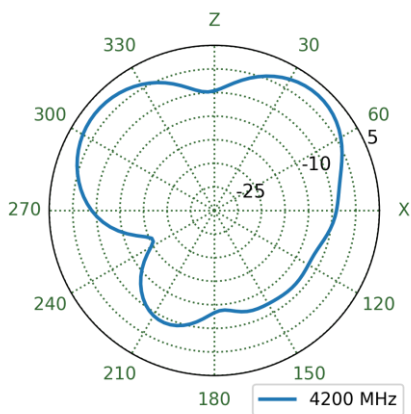

10.24 9x15cm Ground Plane Patterns at 5550MHz

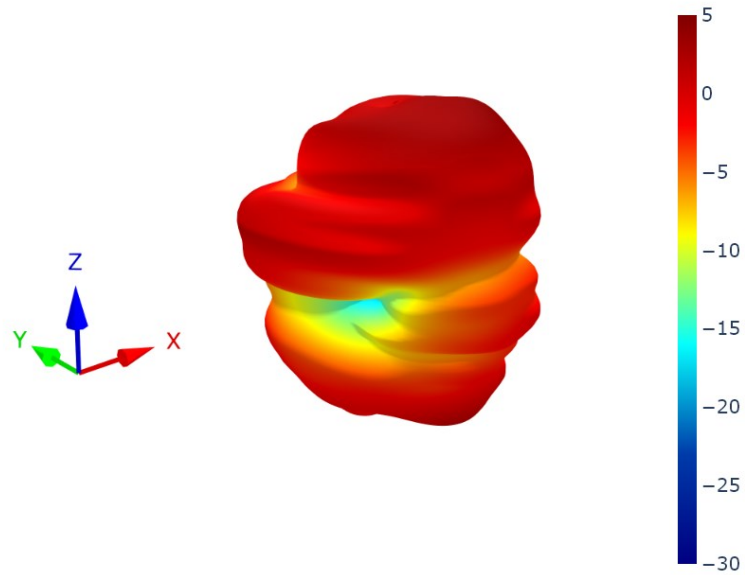

XZ Plane YZ Plane XY Plane

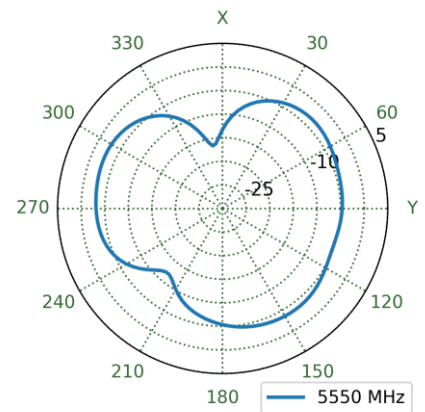
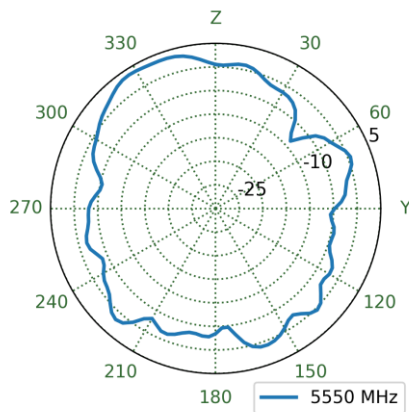
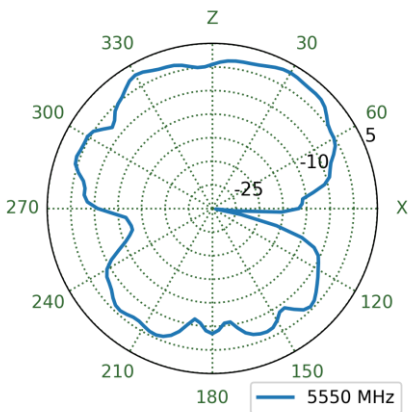

10.25 Free Space Patterns at 5550MHz

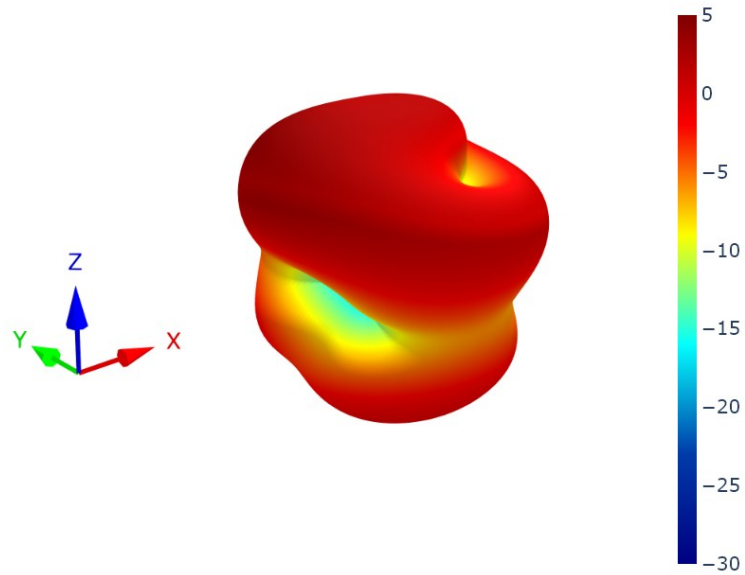

XZ Plane YZ Plane XY Plane

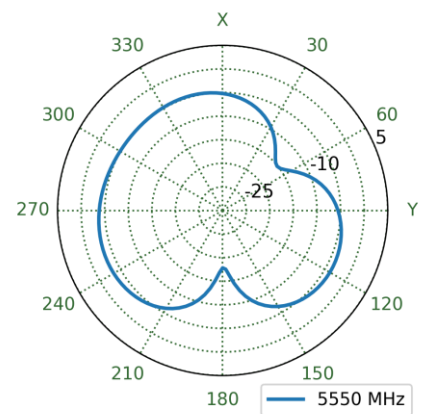
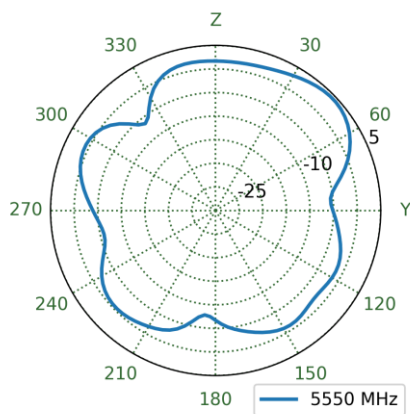
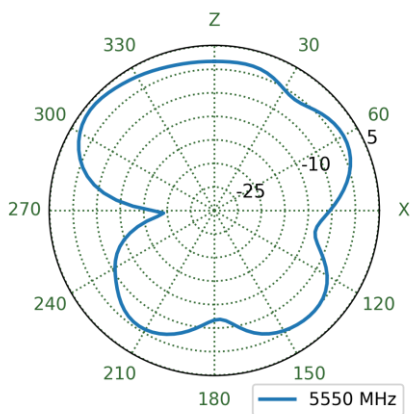

10.26 15x9cm Ground Plane Patterns at 6500MHz

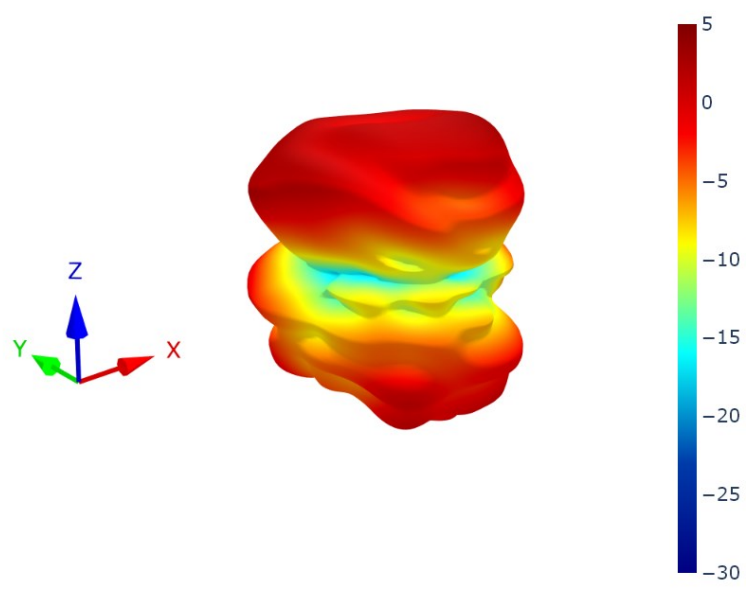

XZ Plane YZ Plane XY Plane

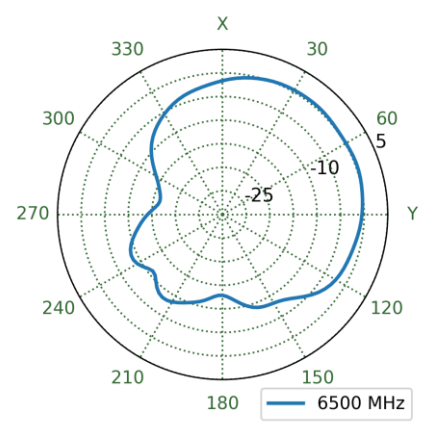
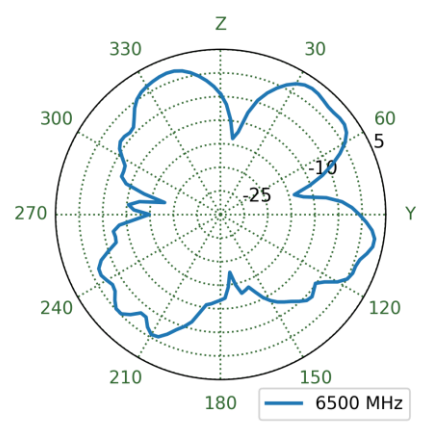
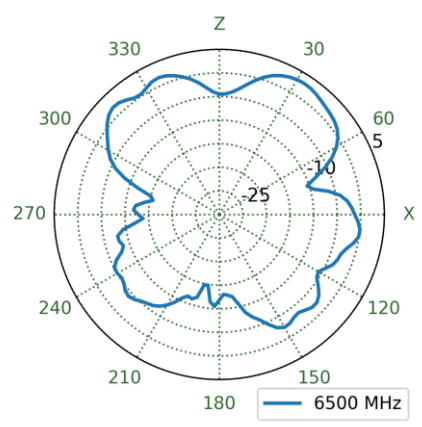

10.27 9x15cm Ground Plane Patterns at 6500MHz

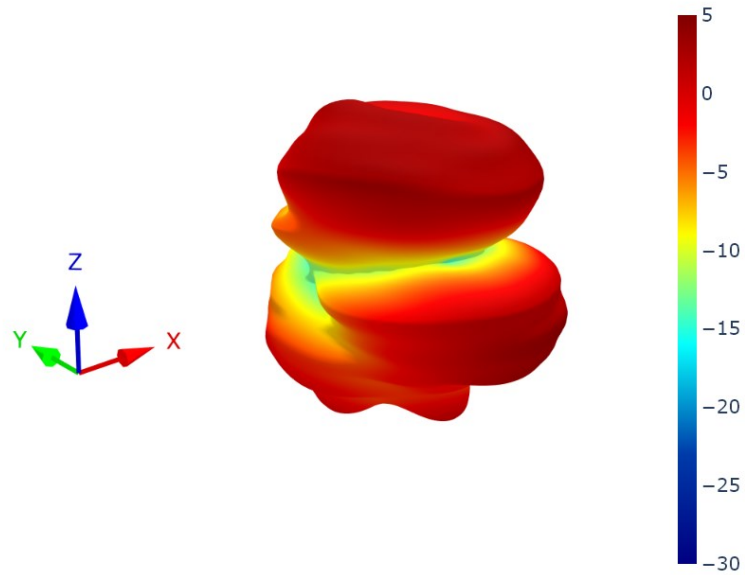

XZ Plane YZ Plane XY Plane

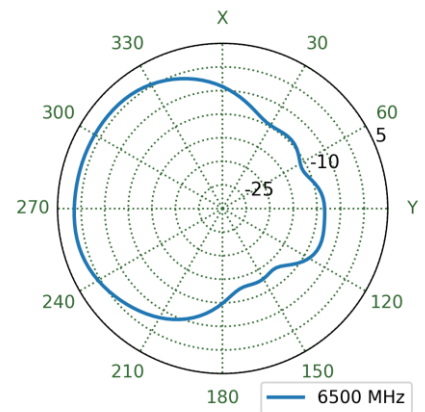
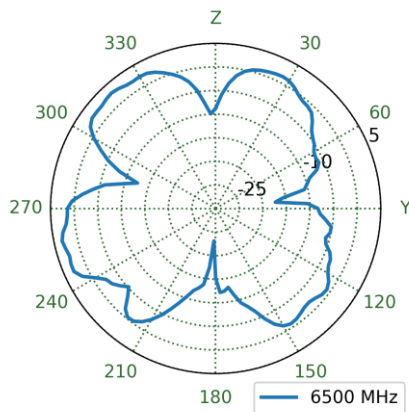
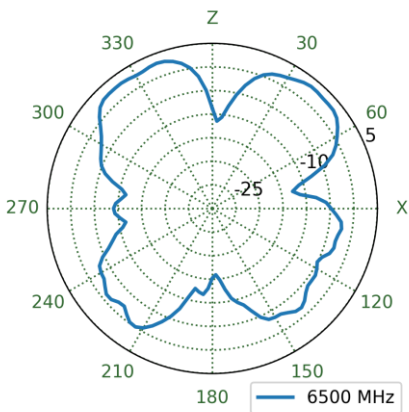

Changelog for the datasheet

SPE-24-8-227 – TU.66.3H31

Revision: A (Initial Release)

Date:	2024-09-13
Notes:	Initial Datasheet Release
Author:	Gary West

Previous Revisions



www.taoglas.com

