

Wi-Fi 6/6E/7 External Whip Antenna



AANE-WH-0150

Request Samples



Check Inventory



Ø 6.5 x 222mm

RoHS/RoHS II Compliant

MSL Level = N/A

Features

- High Efficiency Up to 75%
- High Peak Gain 2.4 / 4.4 / 4.1 dBi @ 2.4 / 5.5 / 6 GHz
- Swivel Connector Design for Straight, Right-Angle and 45-Degree Positioning
- Weatherproof and IP65 Rated Optional
- RP-SMA Plug or SMA Plug Connector

Applications

- Wi-Fi/WLAN Coverage
 - Wi-Fi 7 (802.11be)
 - Wi-Fi 6/6E (802.11ax)
 - Wi-Fi 4/5 (802.11b/g/n/ac)
- Bluetooth®/ ZigBee®/ Thread/ Matter
- Router and Networking
- Smart Irrigation and Pool Control

Product Image



Wi-Fi 6/6E/7 External Whip Antenna



AANE-WH-0150

Request Samples



Check Inventory



Ø 6.5 x 222mm

RoHS/RoHS II Compliant

MSL Level = N/A

Electrical Specification

Parameter	Specification			Unit
Operating Frequency	2400-2500	5150-5850	5925-7125	MHz
VSWR (Typ.)	< 2.0			
Return Loss (Typ.)	> 10			dB
Peak Gain	2.4	4.4	4.1	dBi
Efficiency (Max.)	75	68	57	%
Efficiency (Avg.)	71	63	55	%
Impedance	50			Ω
Polarization	Linear			
Radiation Pattern (Azimuth)	Omni-directional			
Input Power (Ambient 25°C)	5			W

Please note: All measurement data is based on the standard configuration (conducted in free space unless otherwise specified).

Mechanical Specification

Parameter	Specification
Dimensions	Ø 6.5 x 222 mm
Material	ABS ⁽¹⁾
Recommended Torque for Mounting	0.565 N·m
Color	Black
Antenna Type	Whip (Blade) (Dipole)
RF Connector ⁽²⁾	RP-SMA(M)

(1): UV Resistant optional

(2): RF Connector optional

Environmental Specification

Parameter	Specification
Operating Temperature	-40°C to +85°C
Storage Temperature	-40°C to +85°C
IP Rating ⁽¹⁾	IP65
RoHS Complaint	Yes

(1): IP Rating optional



5101 Hidden Creek Ln Spicewood TX 78669
Phone: 512-371-6159 | Fax: 512-351-8858
For terms and conditions of sales, please visit:
www.abracon.com

REVISED: 08-29-24

ABRACON IS
ISO9001-2015
CERTIFIED

Wi-Fi 6/6E/7 External Whip Antenna



AANE-WH-0150

Request Samples



Check Inventory



Ø 6.5 x 222mm

RoHS/RoHS II Compliant

MSL Level = N/A

Ordering Information

Part Number	Description	Connector Option
AANE-WH-0150-RIP	Wi-Fi 6/6E/7 External Whip Antenna with RP-SMA(M) connector & IP rating	RP-SMA(M)
AANE-WH-0150-SIP	Wi-Fi 6/6E/7 External Whip Antenna with SMA(M) connector & IP rating	SMA(M)
AANE-WH-0150-R	Wi-Fi 6/6E/7 External Whip Antenna with RP-SMA(M) connector	RP-SMA(M)
AANE-WH-0150-S	Wi-Fi 6/6E/7 External Whip Antenna with SMA(M) connector	SMA(M)

Note: Different cable and connector configurations that are not listed may be available upon request via [Abracon online support](#)



5101 Hidden Creek Ln Spicewood TX 78669
Phone: 512-371-6159 | Fax: 512-351-8858
For terms and conditions of sales, please visit:
www.abracon.com

REVISED: 08-29-24

ABRACON IS
ISO9001-2015
CERTIFIED

Wi-Fi 6/6E/7 External Whip Antenna



AANE-WH-0150

Request Samples



Check Inventory



Ø 6.5 x 222mm
RoHS/RoHS II Compliant
 MSL Level = N/A

Product Dimensions

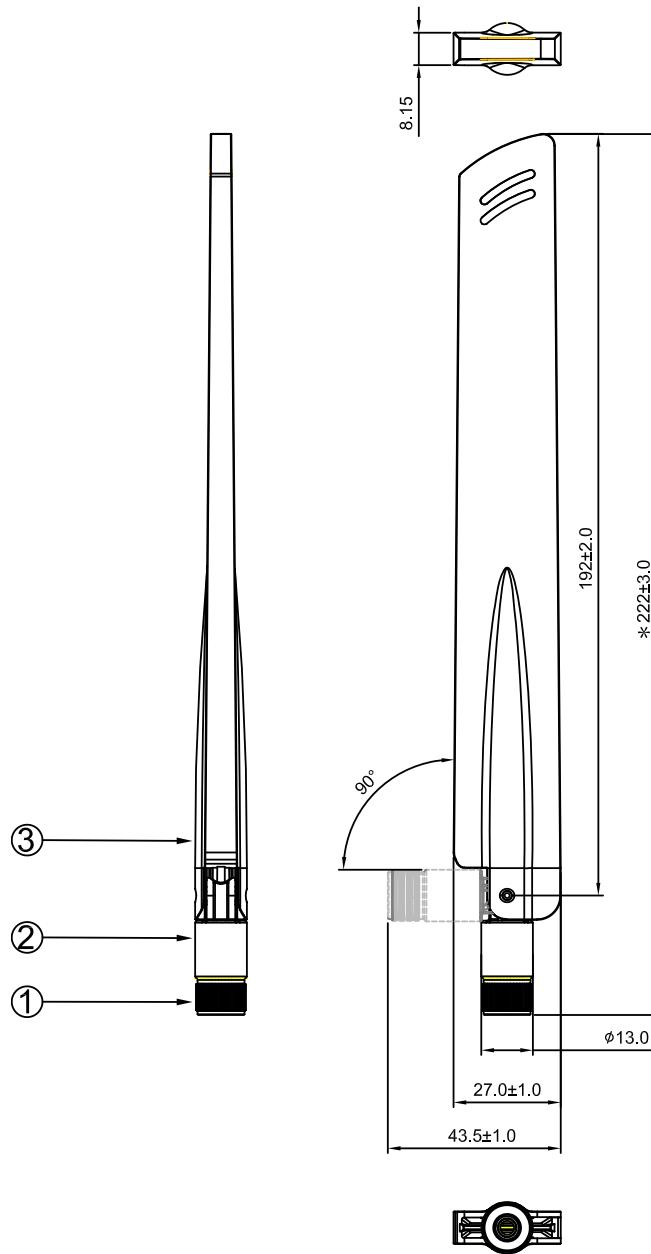

Unit : mm

No.	Name	Material	Finish
1	Connector	RP-SMA(M)	Black
2	Body 1	ABS	Black
3	Body 2	ABS	Black

Wi-Fi 6/6E/7 External Whip Antenna



AANE-WH-0150

Request Samples



Check Inventory



Ø 6.5 x 222mm

RoHS/RoHS II Compliant

MSL Level = N/A

Measurement Setup

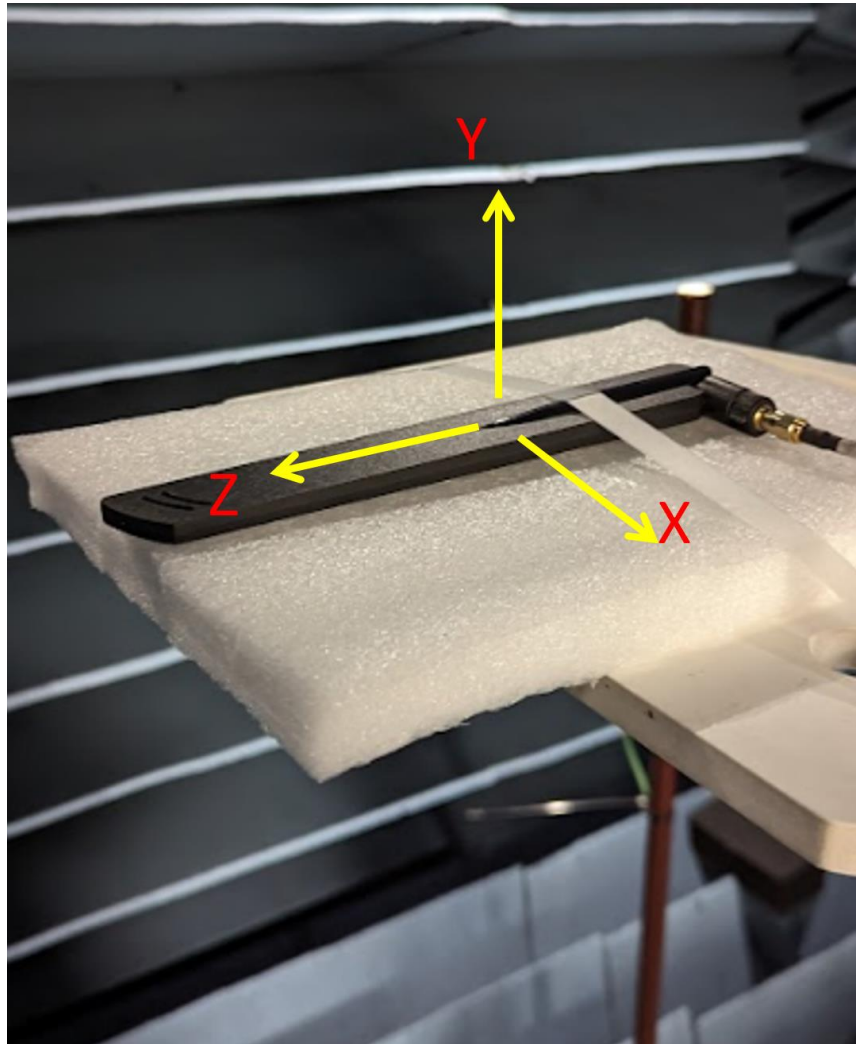

Wi-Fi 6/6E/7 External Whip Antenna



AANE-WH-0150

Request Samples



Check Inventory



Ø 6.5 x 222mm
RoHS/RoHS II Compliant
MSL Level = N/A

Reflection Characteristics – Return Loss & VSWR

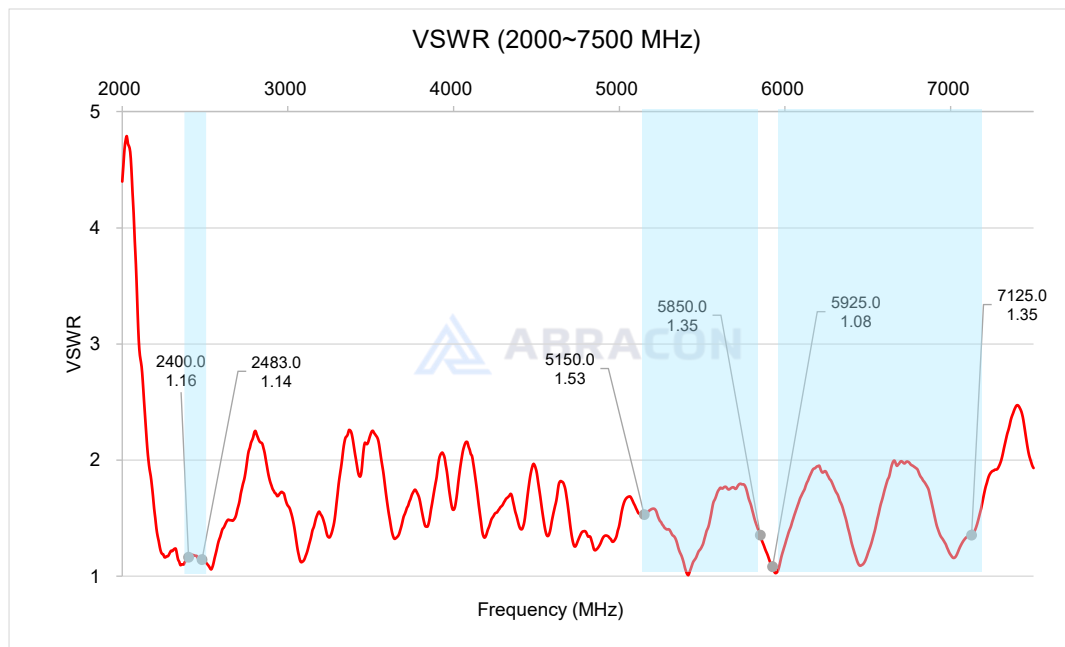
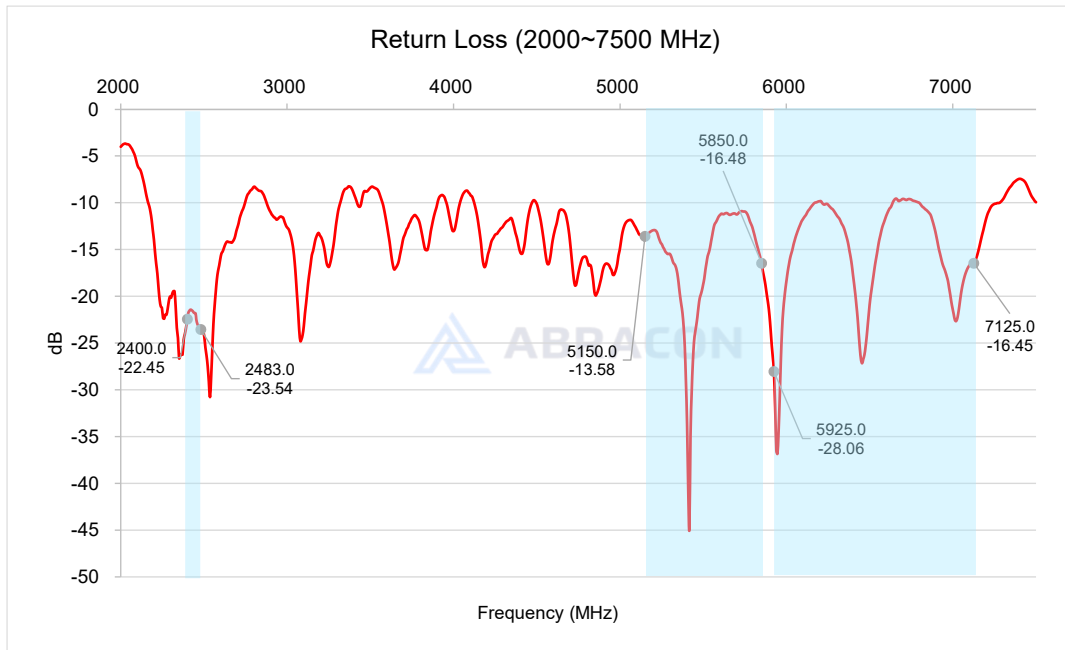

5101 Hidden Creek Ln Spicewood TX 78669
Phone: 512-371-6159 | Fax: 512-351-8858
For terms and conditions of sales, please visit:
www.abracon.com

REVISED: 08-29-24

ABRACON IS
ISO9001-2015
CERTIFIED

Wi-Fi 6/6E/7 External Whip Antenna



AANE-WH-0150

Request Samples



Check Inventory



Ø 6.5 x 222mm
RoHS/RoHS II Compliant
MSL Level = N/A

Radiation Characteristics – Peak Gain

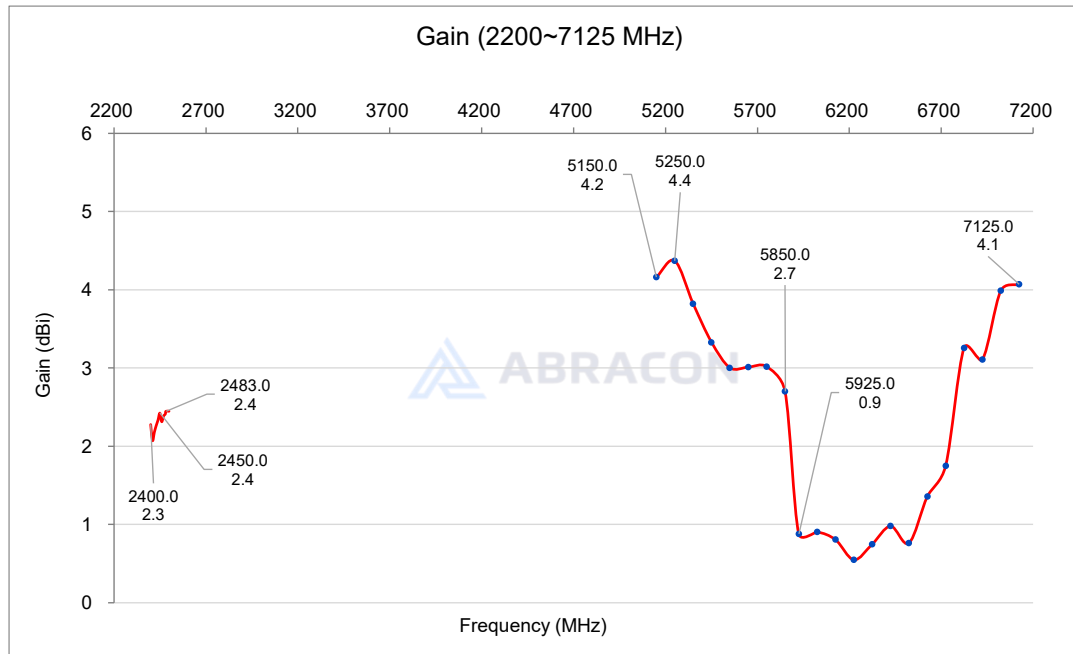

Wi-Fi 6/6E/7 External Whip Antenna



AANE-WH-0150

Request Samples



Check Inventory



Ø 6.5 x 222mm
RoHS/RoHS II Compliant
MSL Level = N/A

Radiation Characteristics – Total Efficiency (%)

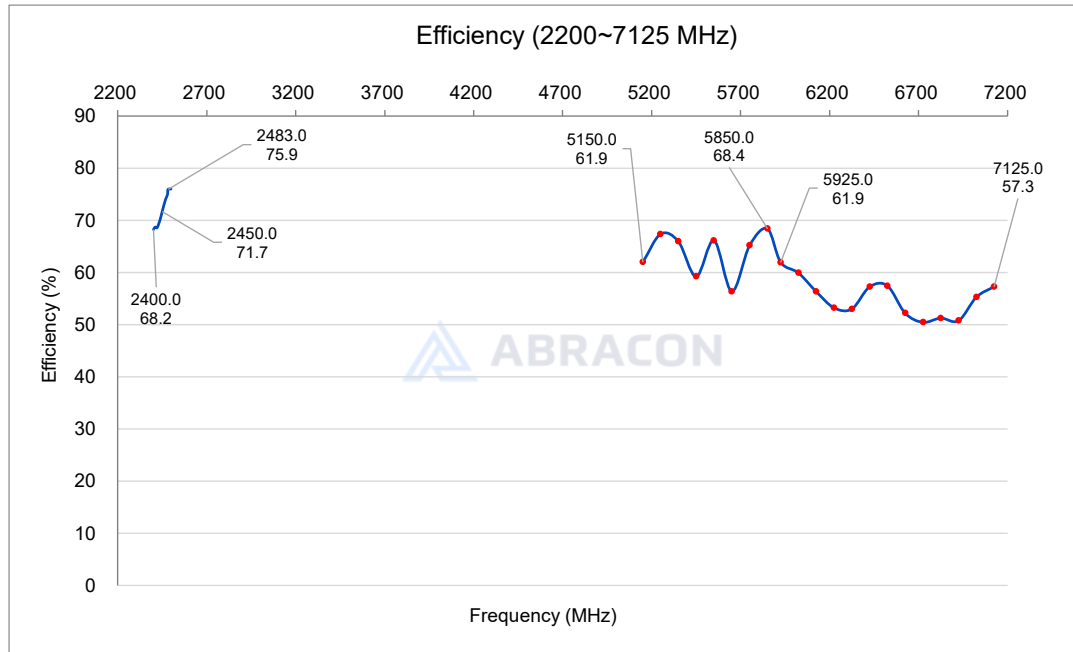

Wi-Fi 6/6E/7 External Whip Antenna



AANE-WH-0150

Request Samples



Check Inventory



Ø 6.5 x 222mm
RoHS/RoHS II Compliant
MSL Level = N/A

Radiation Characteristics –3D & 2D Pattern

2450MHz

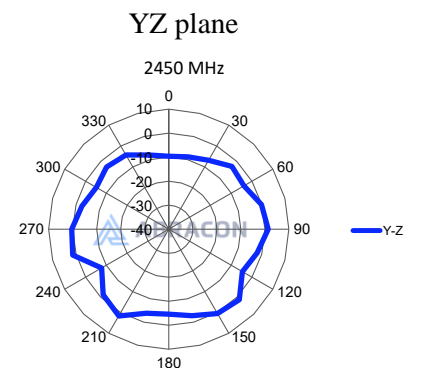
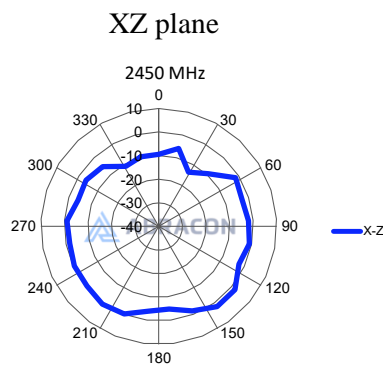
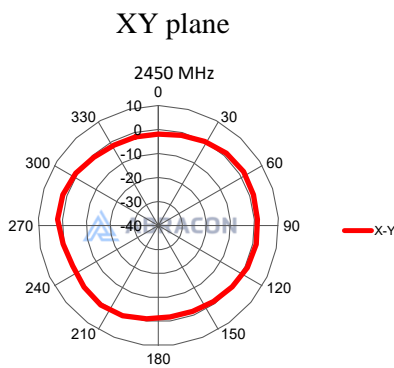
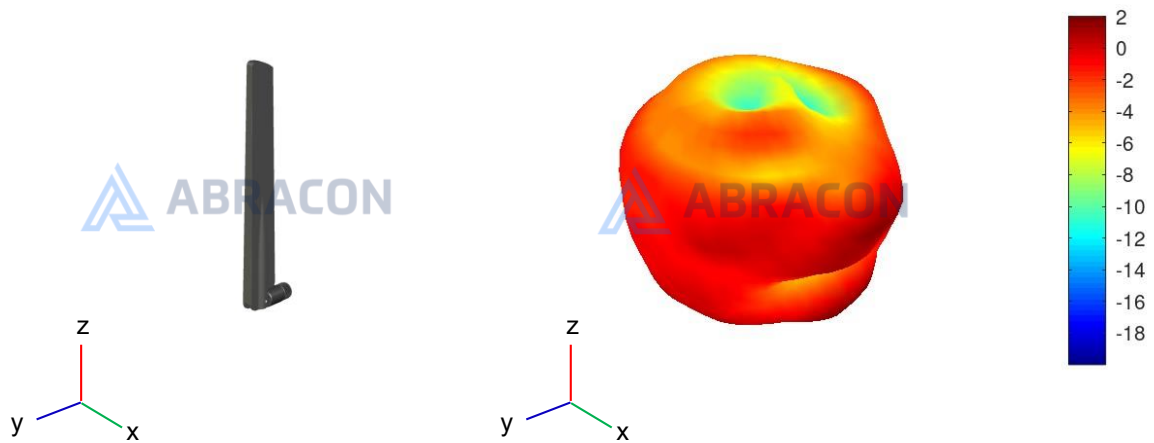

Wi-Fi 6/6E/7 External Whip Antenna



AANE-WH-0150

Request Samples



Check Inventory



Ø 6.5 x 222mm
RoHS/RoHS II Compliant
MSL Level = N/A

5550MHz

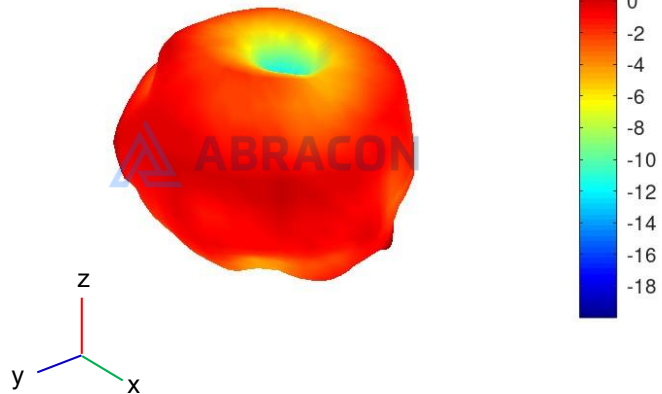

XY plane

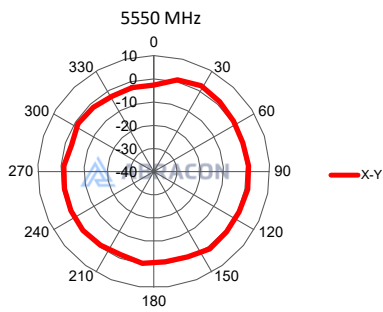

XZ plane

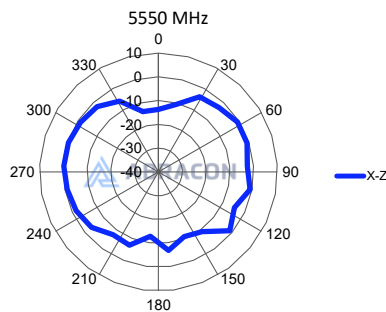

YZ plane

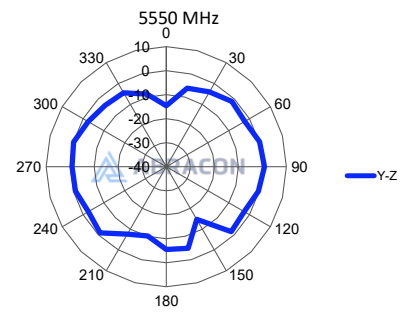

Wi-Fi 6/6E/7 External Whip Antenna



AANE-WH-0150

Request Samples



Check Inventory



Ø 6.5 x 222mm
RoHS/RoHS II Compliant
MSL Level = N/A

6525MHz

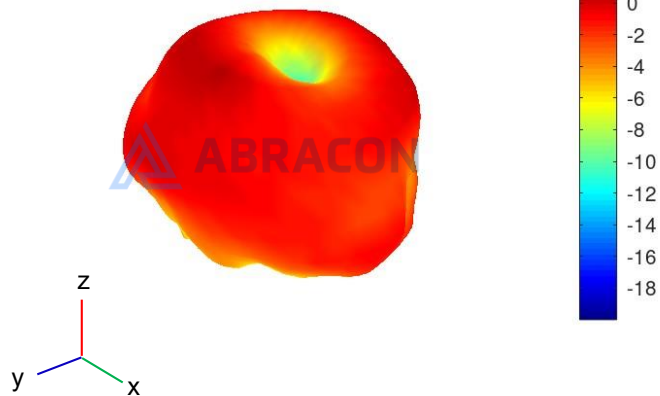

XY plane

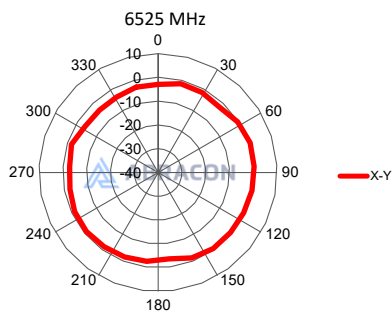

XZ plane

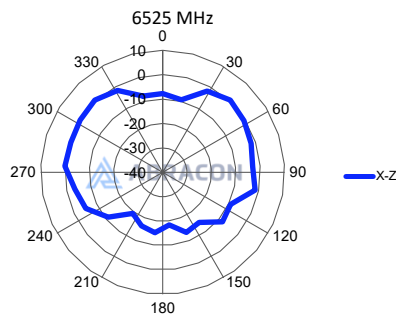

YZ plane

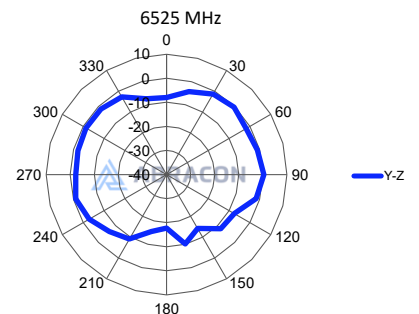

Wi-Fi 6/6E/7 External Whip Antenna



AANE-WH-0150

Request Samples



Check Inventory



Ø 6.5 x 222mm

RoHS/RoHS II Compliant

MSL Level = N/A

Packaging

Number of antennas / PE bag: 50 pcs

Number of PE bags / carton: 10

Total antennas / carton: 500 pcs

ATTENTION: Abracon LLC's products are Commercial-Off-The-Shelf ("COTS"), which are designed, intended, and validated for use in commercial, industrial, and automotive applications. The customer is responsible for testing and verifying the performance of an Abracon solution to meet their system-level requirements.



5101 Hidden Creek Ln Spicewood TX 78669
Phone: 512-371-6159 | Fax: 512-351-8858
For terms and conditions of sales, please visit:
www.abracon.com

REVISED: 08-29-24

ABRACON IS
ISO9001-2015
CERTIFIED