



# TAOGLAS®



# Datasheet

## 7-in-1 Raptor III

**Part No:**  
**MA1290.K.LBICGRT.001**

### **Description:**

7-in-1 Shark Fin Style Combination Antenna with 2 Whiptail options, GNSS, 2\*5G/4G MIMO, 2\*Wi-Fi MIMO, VHF/UHF(TETRA)/LMR (130-150,350-470,700-900MHz) and AM/FM

### **Features:**

- 1\* Active GPS/GLONASS/BeiDou/Galileo L1/B1/E1
- 2\* Worldwide 5G/4G MIMO
- 2\* 2.4 GHz/5.8 GHz Dual-Band Wi-Fi MIMO
- 1\* Active AM/FM
- 1\* Whip with MiniUHF (M) Connector for VHF/UHF/LMR or 700-900MHz
- Housing Dimensions: 190 x 95 x 92mm, Whip Dimensions: 65 x Ø13mm
- Braided 3m cable assembly
- GNSS, AM/FM, 5G/4G MIMO: SMA(M) Connector
- Wi-Fi MIMO: RP-SMA(M) Connector
- Whip Option 1 - VHF/UHF(TETRA)/LMR covering 130-150MHz and 350-470MHz
- Whip Option 2 – LMR covering 700 - 900MHz
- RoHS & REACH Compliant



1. Introduction	3
2. Specifications	4
3. Active Antenna Characteristics	9
4. Antenna Characteristics	12
5. Radiation Patterns	21
6. Mechanical Drawing	39
7. Packaging	40
8. Installation	41
9. Application Note	43
<hr/>	
Changelog	55

Taoglas makes no warranties based on the accuracy or completeness of the contents of this document and reserves the right to make changes to specifications and product descriptions at any time without notice. Taoglas reserves all rights to this document and the information contained herein. Reproduction, use or disclosure to third parties without express permission is strictly prohibited.



# 1. Introduction



The Taoglas Raptor III MA1290 is a high performance 7-in-1 “Shark Fin” style combination antenna. It provides multiple antenna connections in a sleek, covert enclosure and is suitable for all automotive and commercial trucking applications. The Raptor III has been engineered to be mounted directly on the vehicle roof and is supplied with 3m cables and SMA connectors as standard.

The Raptor III is designed to combine and active multiband GNSS (GPS/GLONASS/BeiDou/Galileo), 2\*5G/4G Cellular MIMO, 2\*Dual-Band Wi-Fi, Active AM/FM and comes with two VHF/UHF(TETRA)/LMR covering either 130-150,350-470, or 700-900MHz for regional specific applications. All high-performance antennas are packaged in a compact, robust, IP67 rated enclosure. The whip antennas attach to the rear of the enclosure covers all frequency bands used for specialist communication systems such as public safety and first responders.

The cellular antennas in the Raptor III cover all 4G, and the new Sub 6GHz 5G cellular bands offering efficiencies of up to 80%. Fallback to 3G and 2G bands are possible where 5G and 4G is not accessible. The high performing Wi-Fi antennas cover both the 2.4GHz and 5.8GHz Wi-Fi bands. The whip antenna covers the Terrestrial Trunked Radio (TETRA) bands between 380 – 470MHz as standard and can be customized for other communication frequency bands. It is connected via a threaded M6 Female connector to the M6 male connector on the enclosure. Low loss 1.5DS cables are used that can allow for longer cable installations if required.

The Raptor III has a robust, impact resistant, UV resistant, PC enclosure and is easy to install. It requires just one single M20 hole, unlike many other vehicle mount solutions currently on the market that require multiple mounting holes. This single hole mounting substantially reduces installation time & cost and reduces damage to the vehicle.

Typical Applications Include:

- Transportation and Fleet Management
- Autonomous Driving and Robotics
- FirstNet, First Responders and Emergency Services

The cables, connectors and whip are fully customizable, the antenna is supplied with two whip antennas in the package. One longer whip for wideband specialist comms and a short whip for LMR only. For further information or installation instructions contact your regional Taoglas customer support team.

## 2. Specifications

GNSS Frequency Bands Covered							
<b>GPS/QZSS</b>	L1 1575.42MHz	L2 1227.6MHz	L5 1176.45MHz	L6 1278.75MHz			
	■	□	□	□			
<b>GLONASS</b>	L5R 1176.45MHz	L3PT 1201.5MHz	L2PT 1246MHz	L1CR 1575.42MHz	L1PT 1602MHz		
	□	□	□	■	■		
<b>Galileo</b>	E5a 1176.45MHz	E5b 1201.5MHz	E4 1215MHz	E3 1256MHz	E6 1278.75MHz	E2 1561MHz	L1 1575.42MHz
	□	□	□	□	□	■	■
<b>BeiDou</b>	B1 1561MHz	B2 1207.14MHz	B3 1268.52MHz				
	■	□	□				
<b>Compass</b>	E5B(B2)/ E6(B3) 1268.56MHz	E2(B1) 1561MHz					
	□	■					
<b>SBAS</b>	Omnistar 1542.5MHz	WAAS/EGN OS 1575.42MHz					
	□	■					

GPS/GLONASS/BeiDou/Galileo Electrical			
Frequency (MHz)	1561	1575.42	1602
<b>VSWR (max.)</b>	2.0:1	2.0:1	2.0:1
<b>Efficiency (%)</b>	53.3	55.8	60.6
<b>Peak Gain (dBi)</b>	2.8	3.3	3.7
<b>Polarization</b>	RHCP		
<b>Impedance</b>	50Ω		
<b>Cable</b>	3-meter standard, fully customizable		
<b>Connector</b>	SMA(M) standard, fully customizable		

LNA and Filter Electrical Properties			
Frequency (MHz)	1561	1575.42	1602
VSWR (max.)	2.0:1	2.0:1	2.0:1
Gain@1.8V (Typ.)	23 dB	23 dB	23 dB
Gain@3.0V (Typ.)	29 dB	28 dB	29 dB
Gain@5.5V (Typ.)	32 dB	32 dB	31 dB
Noise@1.8V (Typ.)	2.9 dB	2.5 dB	2.8 dB
Noise@3.0V (Typ.)	2.9 dB	2.6 dB	2.7 dB
Noise@5.5V (Typ.)	3 dB	2.6 dB	2.9 dB
Power consumption@1.8V (Typ.)	4.5 mA		
Power consumption@3.0V (Typ.)	10 mA		
Power consumption@5.5V (Typ.)	22 mA		
Total Specification (Through Antenna, SAW Filter and LNA)			
Frequency (MHz)	1561	1575.42	1602
Gain@3.0V (Typ.)	35 dB	35 dB	35 dB
Impedance	50Ω		

5G/4G Electrical									
Band	Frequency (MHz)		Efficiency (%)	Average Gain (dB)	Peak Gain (dBi)	Impedance	Max Power Input	Polarization	Radiation Pattern
5G NR/4G Band 71	617~698	MIMO 1	21.5	-6.7	-3.7	50Ω	10W	Linear	Omni
		MIMO 2	21.3	-6.7	-3.8				
4G/3G Band 12,13,14,17,28,29	698~806	MIMO 1	24.8	-6.1	-1.9				
		MIMO 2	27.7	-5.6	-2.3				
4G/3G Band 5,8,18,19,20,26,27	824~960	MIMO 1	32.1	-4.9	-0.3				
		MIMO 2	33.5	-4.8	-0.8				
5G NR/4G Band 21,32,74,75,76	1427~1518	MIMO 1	36.2	-4.4	1.6				
		MIMO 2	28.7	-5.4	0.8				
4G/3G Band 1,2,3,4,9,23,25,35,39,66	1710~2200	MIMO 1	35	-4.4	3.6				
		MIMO 2	35.2	-4.5	2				
4G/3G Band 7,38,41	2490~2690	MIMO 1	30.4	-5.2	1.6				
		MIMO 2	31.2	-5.1	1.8				
5G NR Band 22,42,48,77,78,79	3300~5000	MIMO 1	20.3	-6.9	-0.7				
		MIMO 2	19.6	-7.1	0.6				
LTE5200/ Wi-Fi 5800	5150~5925	MIMO 1	16.1	-7.9	0.1				
		MIMO 2	17.2	-7.6	0.4				

\*Tested on 30x30cm ground Plane with 3m TGC-1.5DS Cable

Wi-Fi Electrical									
Band	Frequency (MHz)		Efficiency (%)	Average Gain (dB)	Peak Gain (dBi)	Impedance	Max Power Input	Polarization	Radiation Pattern
2.4GHz Wi-Fi	2400~2500	MIMO 1	29	-5.4	0	50 Ω	10W	Linear	Omni
		MIMO 2	30.4	-5.2	-0.1				
5.8GHz Wi-Fi	5150~5850	MIMO 1	19.5	-7.1	0.1				
		MIMO 2	21.8	-6.6	0.9				

\*Tested on 30x30cm ground Plane with 3m TGC-1.5DS Cable

VHF/UHF/LMR Electrical	
Frequency (MHz)	135-900MHz
VSWR (max.)	3.8:1
Efficiency (%) typ	30
Peak Gain (dBi) typ	1.6
Average Gain (dB) typ	-5
Return Loss (dB)	-11.5
Polarization	Linear - Vertical
Impedance	50Ω
Cable	TGC-200, 3-meter standard, fully customizable
Connector	Mini UHF(M) standard, fully customizable

Active AM/FM Electrical	
AM Radio Bands	FM Radio Bands
535-1605KHz	88-108MHz
FM LNA Gain @12V	15dB

<b>Mechanical</b>	
Dimensions (Not including Whip)	Length - 191mm / Width - 95.7mm / Height - 98.3mm
Whip Length	Long Whip(Wideband) – 430mm Short Whip(LMR Only) – 65mm
Whip Coil Diameter	Ø6mm
Whip Base Diameter	Ø14mm
Enclosure	UV Resistant PC
Cable	3m Braided TGC-200
Connector	GNSS, AM/FM, 5G/4G MIMO: SMA(M) Wi-Fi MIMO: RP-SMA(M) VHF/UHF(TETRA)/LMR (130-150,350-470,700-900MHz): Mini UHF (M)
Base and Thread	Nickel plated steel
Thread Diameter	M20 1.5P
Weight (including cables & whip)	972g
<b>Environmental</b>	
Protection	IP67
Temperature Range	-40°C to +85°C
Cable Pull Force	17.28 Kgf-cm

5G/4G Bands MIMO 1 & 2			
Band Number	5G NR / FR1 / LTE / LTE-Advanced / WCDMA / HSPA / HSPA+ / TD-SCDMA		
	Uplink	Downlink	Covered
1	UL: 1920 to 1980	DL: 2110 to 2170	✓
2	UL: 1850 to 1910	DL: 1930 to 1990	✓
3	UL: 1710 to 1785	DL: 1805 to 1880	✓
4	UL: 1710 to 1755	DL: 2110 to 2155	✓
5	UL: 824 to 849	DL: 869 to 894	✓
7	UL: 2500 to 2570	DL: 2620 to 2690	✓
8	UL: 880 to 915	DL: 925 to 960	✓
9	UL: 1749.9 to 1784.9	DL: 1844.9 to 1879.9	✓
11	UL: 1427.9 to 1447.9	DL: 1475.9 to 1495.9	✓
12	UL: 699 to 716	DL: 729 to 746	✓
13	UL: 777 to 787	DL: 746 to 756	✓
14	UL: 788 to 798	DL: 758 to 768	✓
17	UL: 704 to 716	DL: 734 to 746	✓
18	UL: 815 to 830	DL: 860 to 875	✓
19	UL: 830 to 845	DL: 875 to 890	✓
20	UL: 832 to 862	DL: 791 to 821	✓
21	UL: 1447.9 to 1462.9	DL: 1495.9 to 1510.9	✓
22	UL: 3410 to 3490	DL: 3510 to 3590	✓
23	UL: 2000 to 2020	DL: 2180 to 2200	✓
24	UL: 1625.5 to 1660.5	DL: 1525 to 1559	✓
25	UL: 1850 to 1915	DL: 1930 to 1995	✓
26	UL: 814 to 849	DL: 859 to 894	✓
27	UL: 807 to 824	DL: 852 to 869	✓
28	UL: 703 to 748	DL: 758 to 803	✓
29	UL: -	DL: 717 to 728	✓
30	UL: 2305 to 2315	DL: 2350 to 2360	✓
31	UL: 452.5 to 457.5	DL: 462.5 to 467.5	✗
32	UL: -	DL: 1452 – 1496	✓
34		2010 to 2025	✓
35		1850 to 1910	✓
38		2570 to 2620	✓
39		1880 to 1920	✓
40		2300 to 2400	✓
41		2496 to 2690	✓
42		3400 to 3600	✓
43		3600 to 3800	✓
46		5150 to 5925	✓
48		3550 to 3700	✓
66	UL: 1710-1780	DL: 2110-2200	✓
71		617 to 698	✓
74/75/76		1427 to 1518	✓
77		3300 to 4200	✓
78		3300 to 3800	✓
79		4400 to 5000	✓
85		698 to 746	✓

\*Bands References from: XGP Forum

### 3. Active Antenna Characteristics

#### 3.1 Block Diagram (Active antenna)

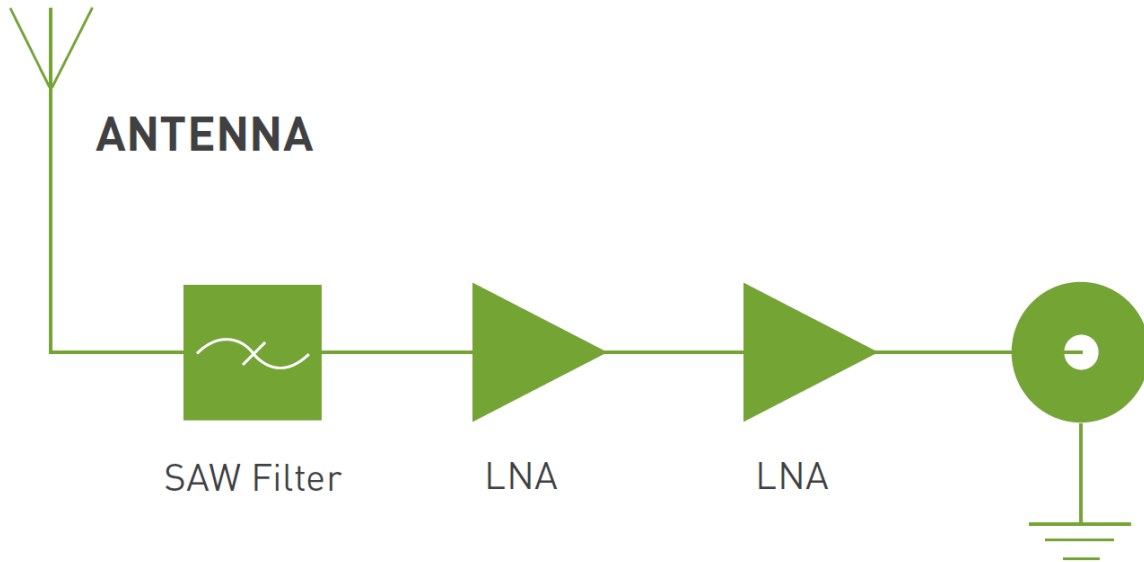

#### 3.2 Active GNSS Measurements

GNSS LNA Gain

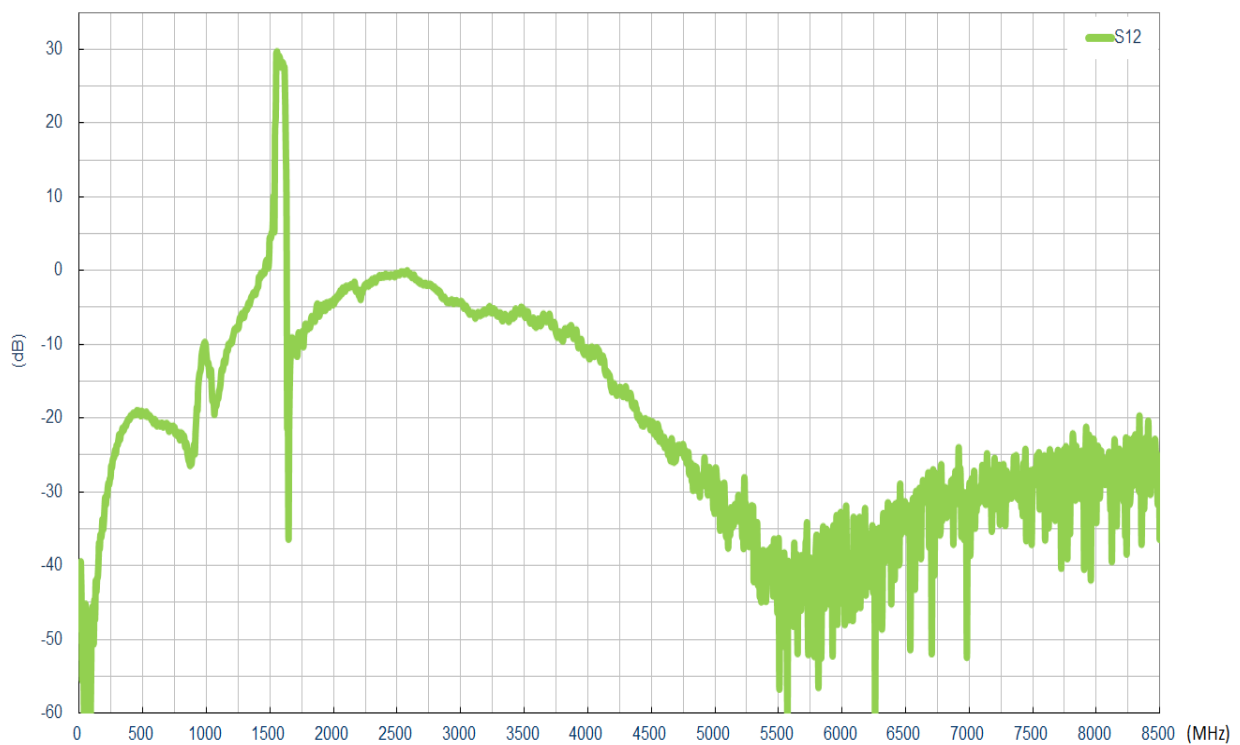

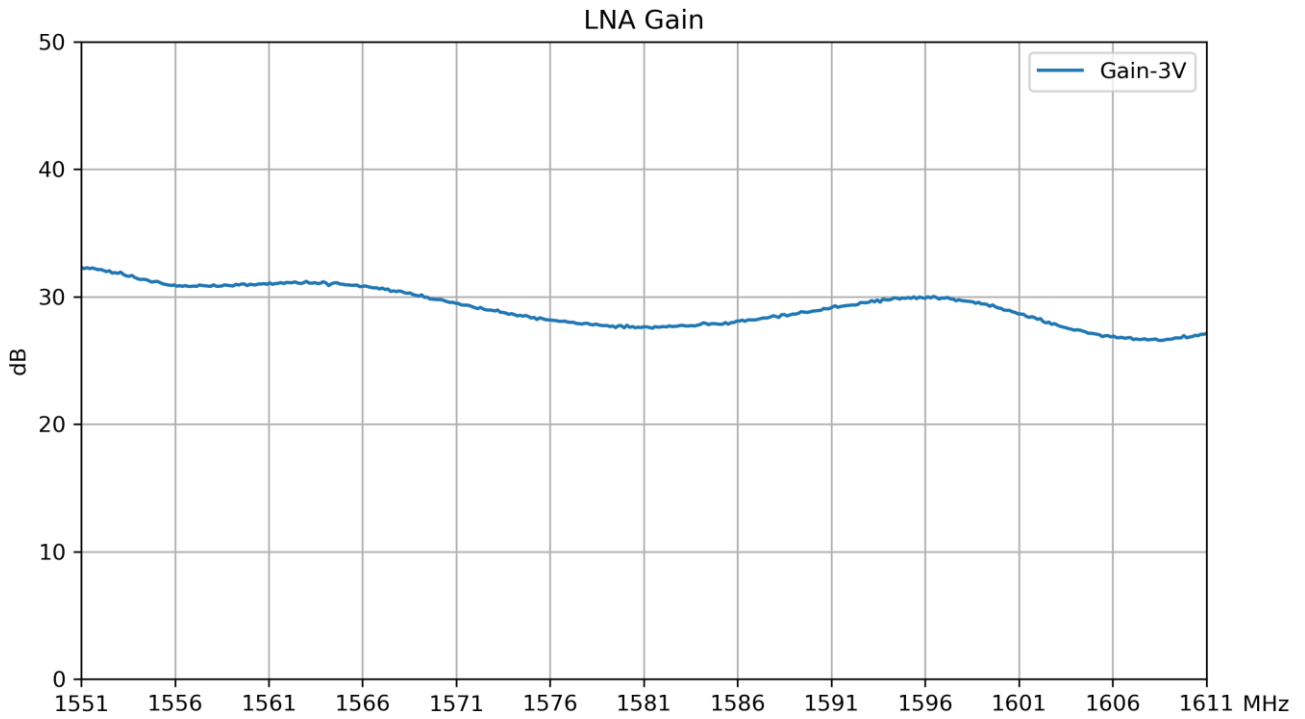

**GNSS LNA Noise Figure @ 3.0V**

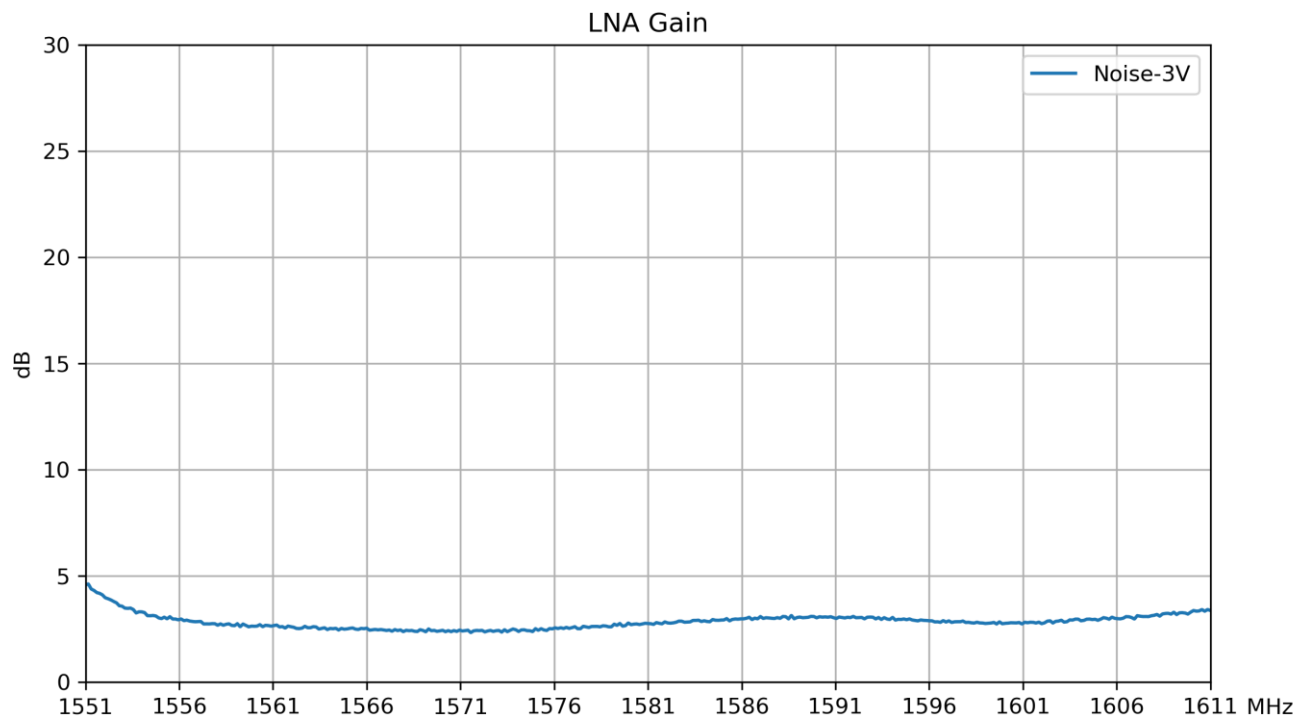

### 3.3 Active FM Measurements

#### FM LNA Gain

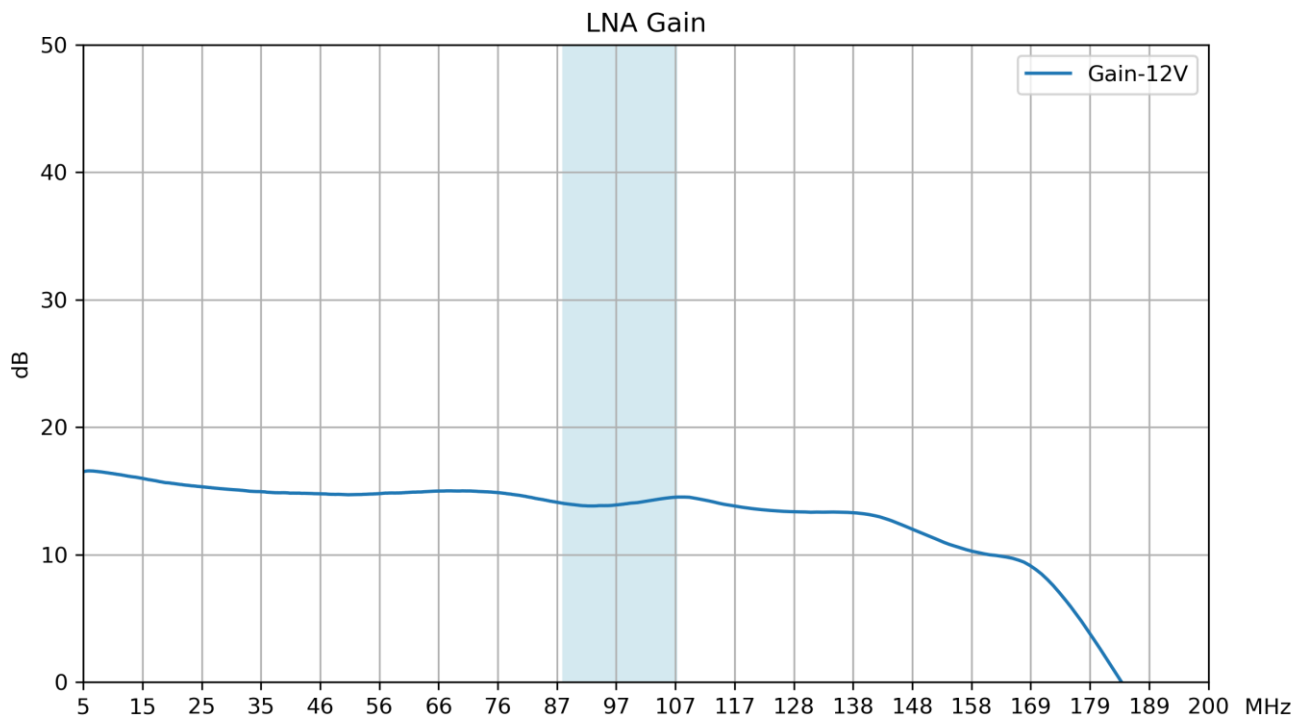

## 4. Antenna Characteristics

### 4.1 Test Setup – 30\*30cm Ground Plane

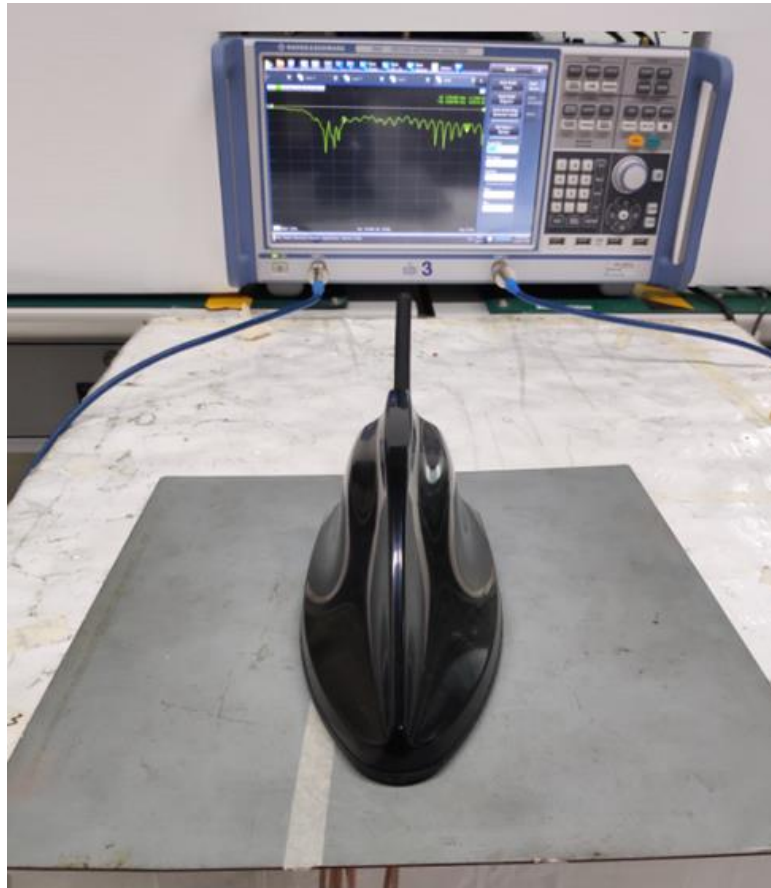

## 4.2 Return Loss - Cellular

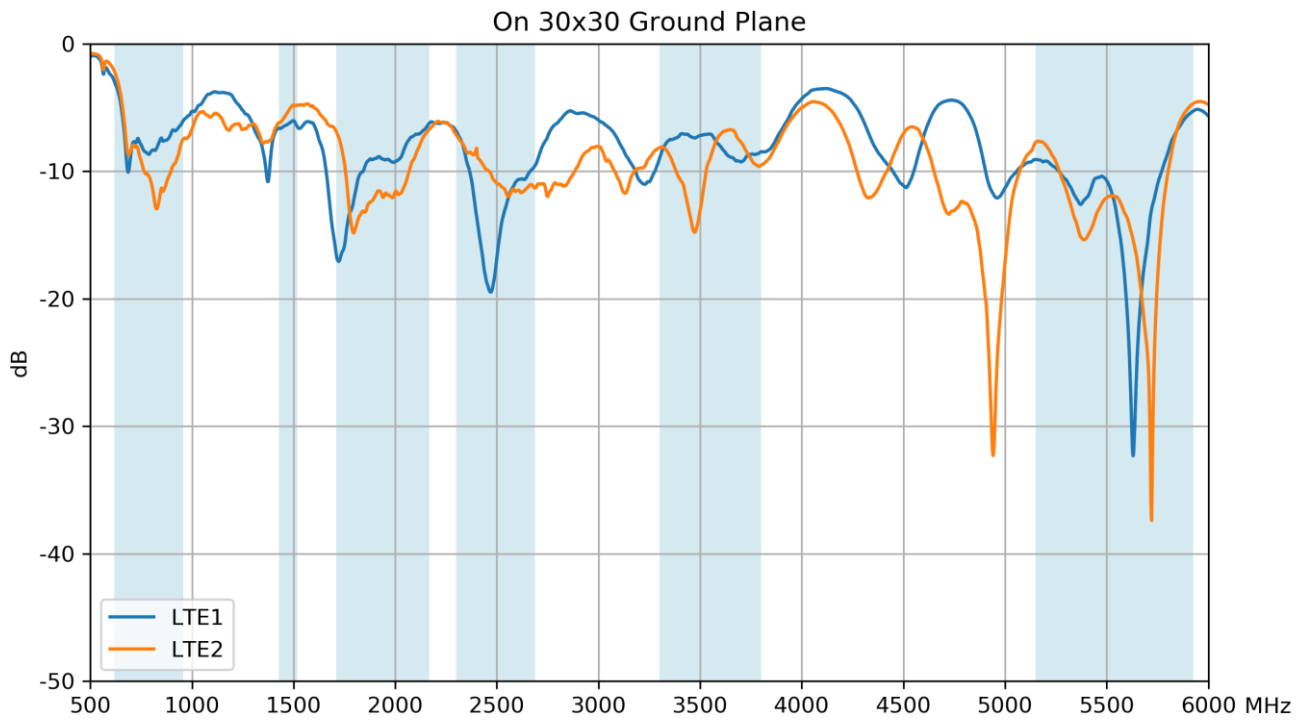

## 4.3 Return Loss – Wi-Fi

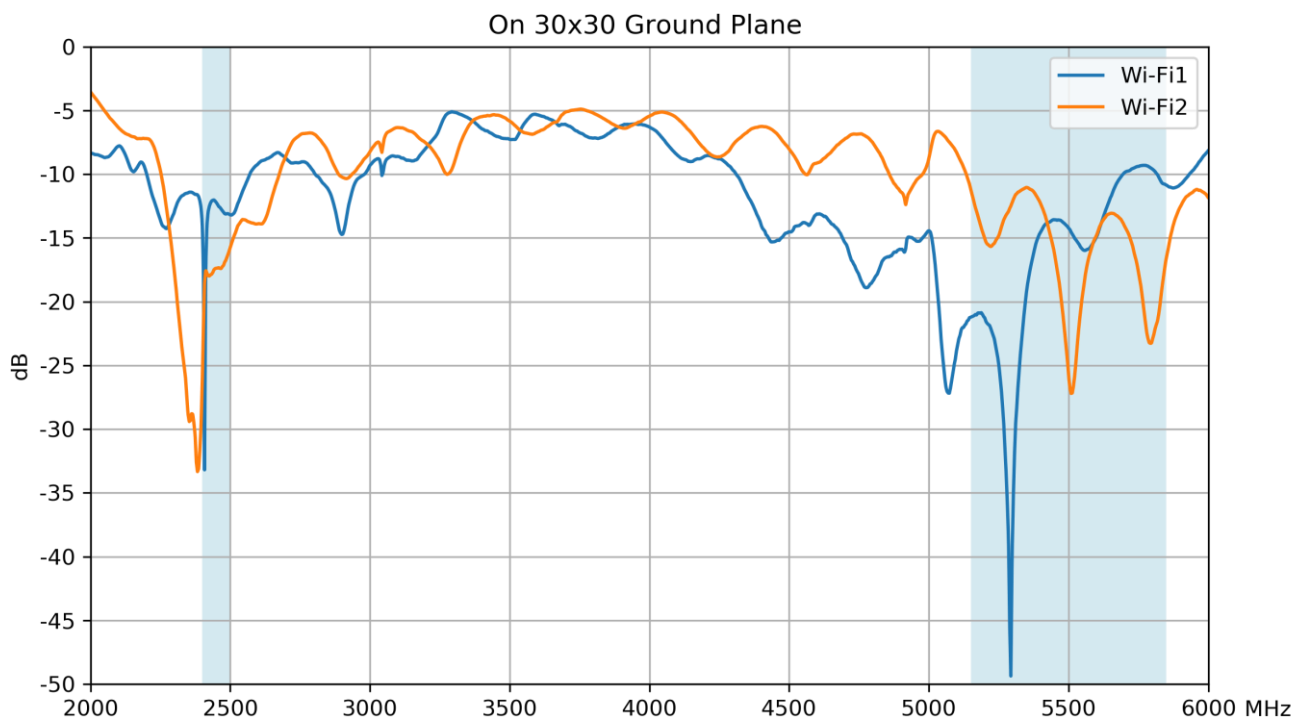

#### 4.4 Return Loss - GNSS

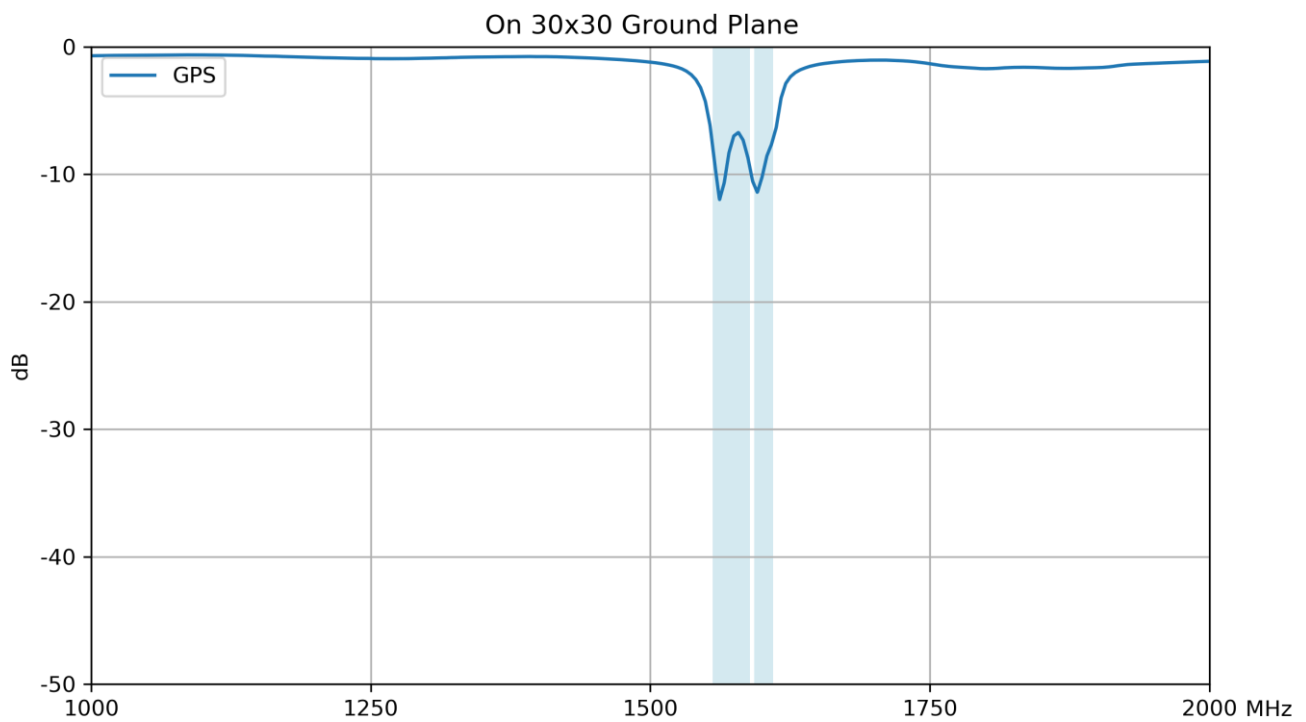

#### 4.5 Return Loss – FM

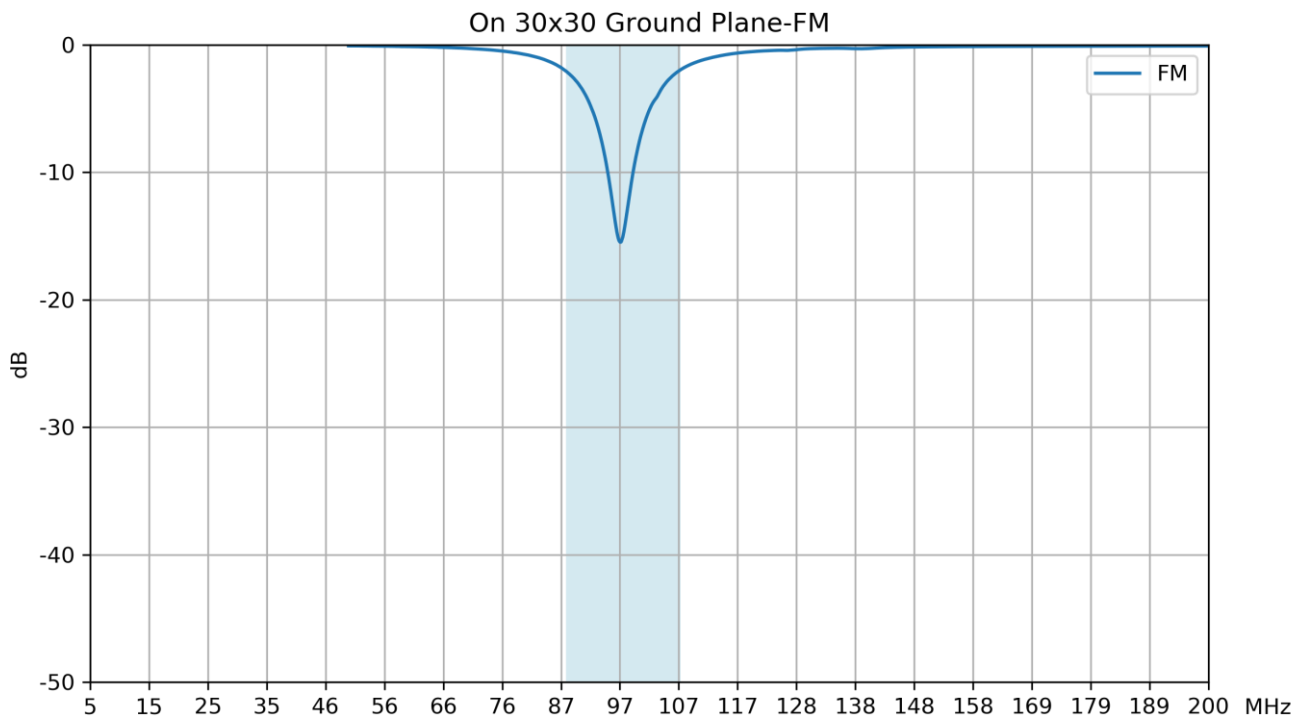

## 4.6 Return Loss – VHF/UHFLMR (150-900MHz)

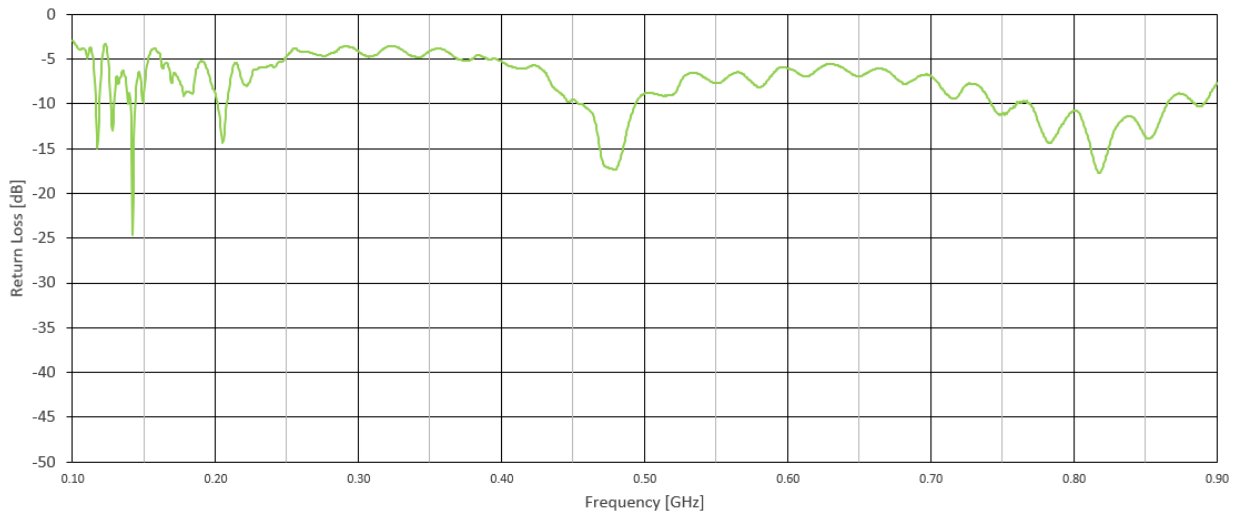

## 4.7 Isolation

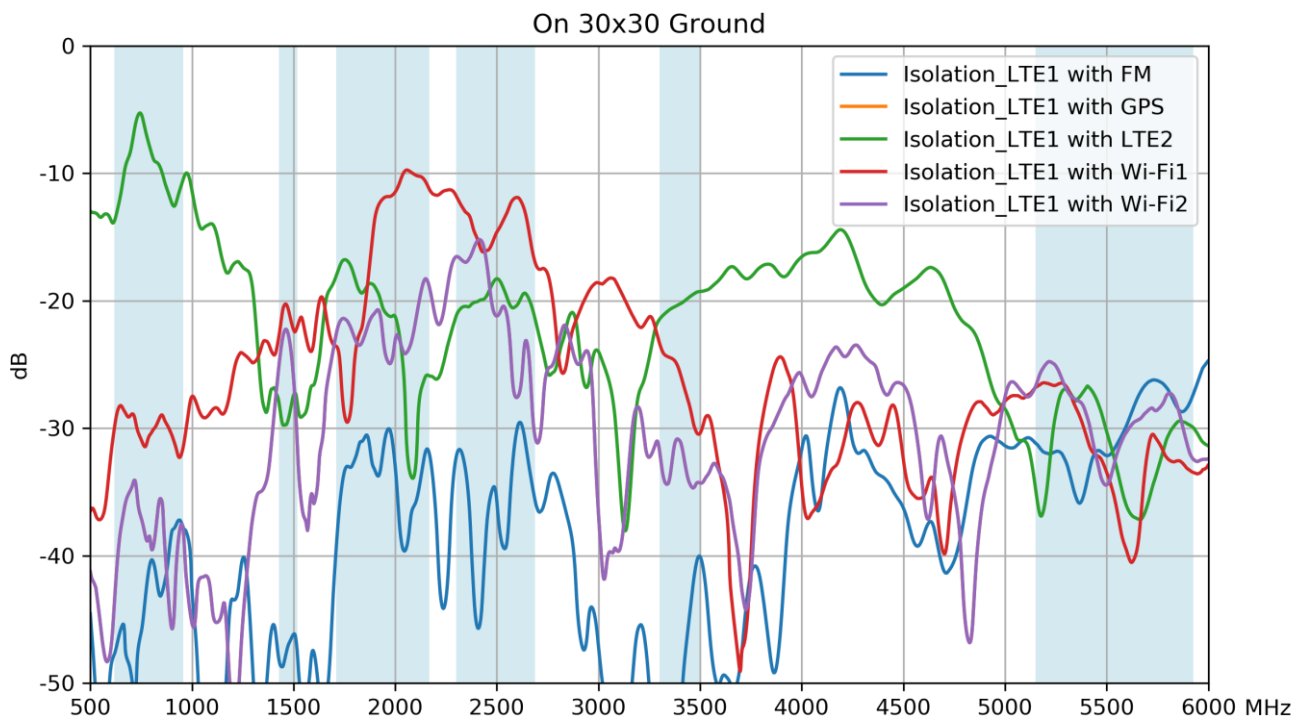

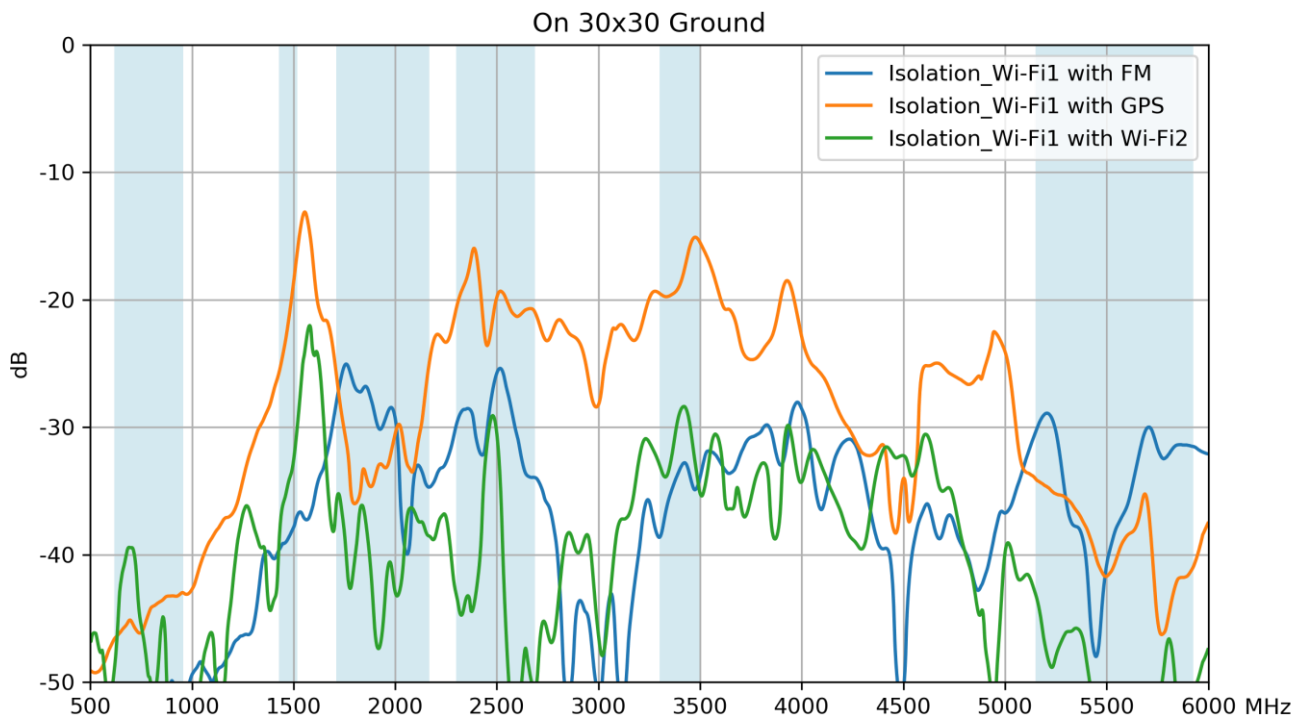

## 4.8 Efficiency - GNSS

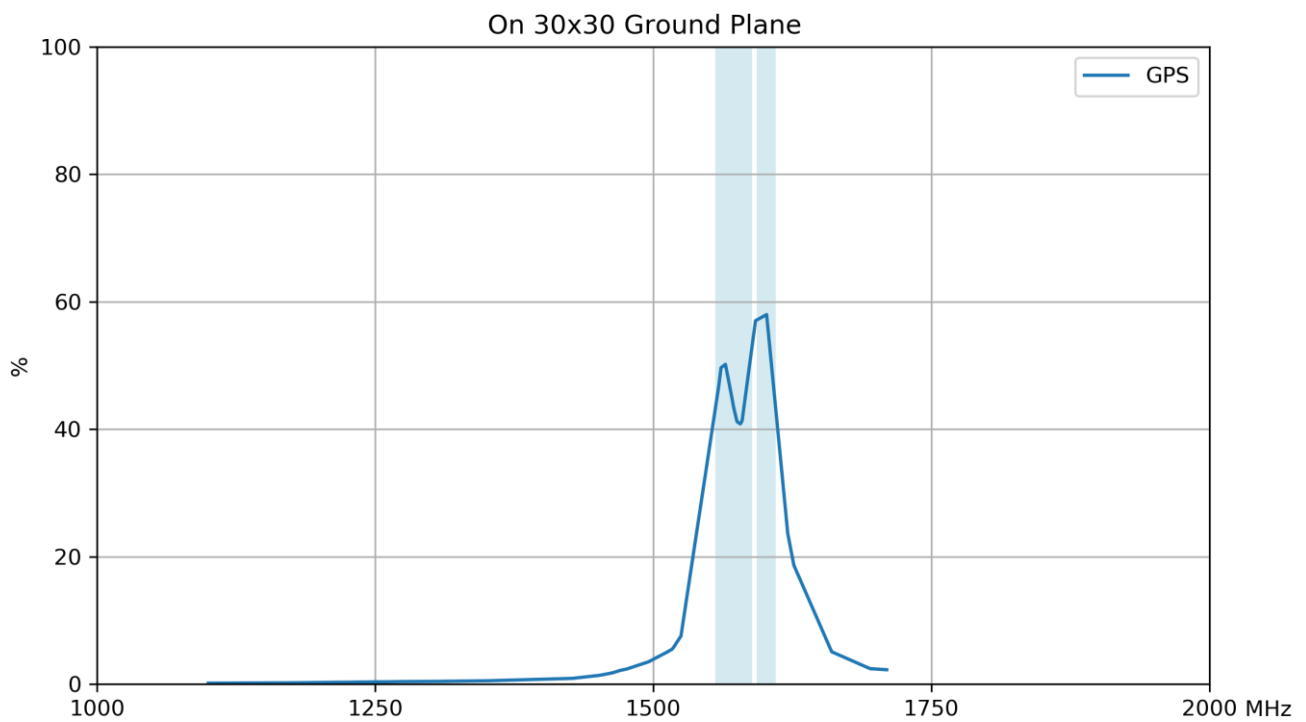

## 4.9 Efficiency - Cellular

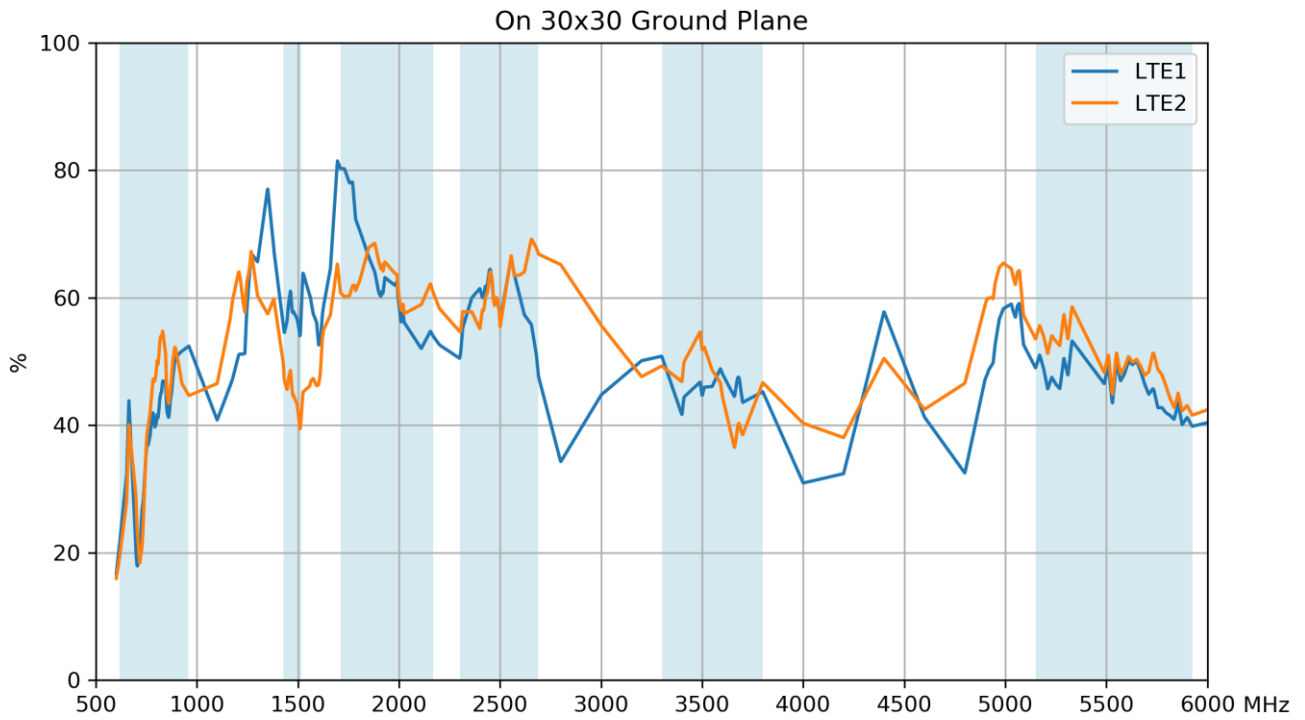

## 4.10 Efficiency - Wi-Fi

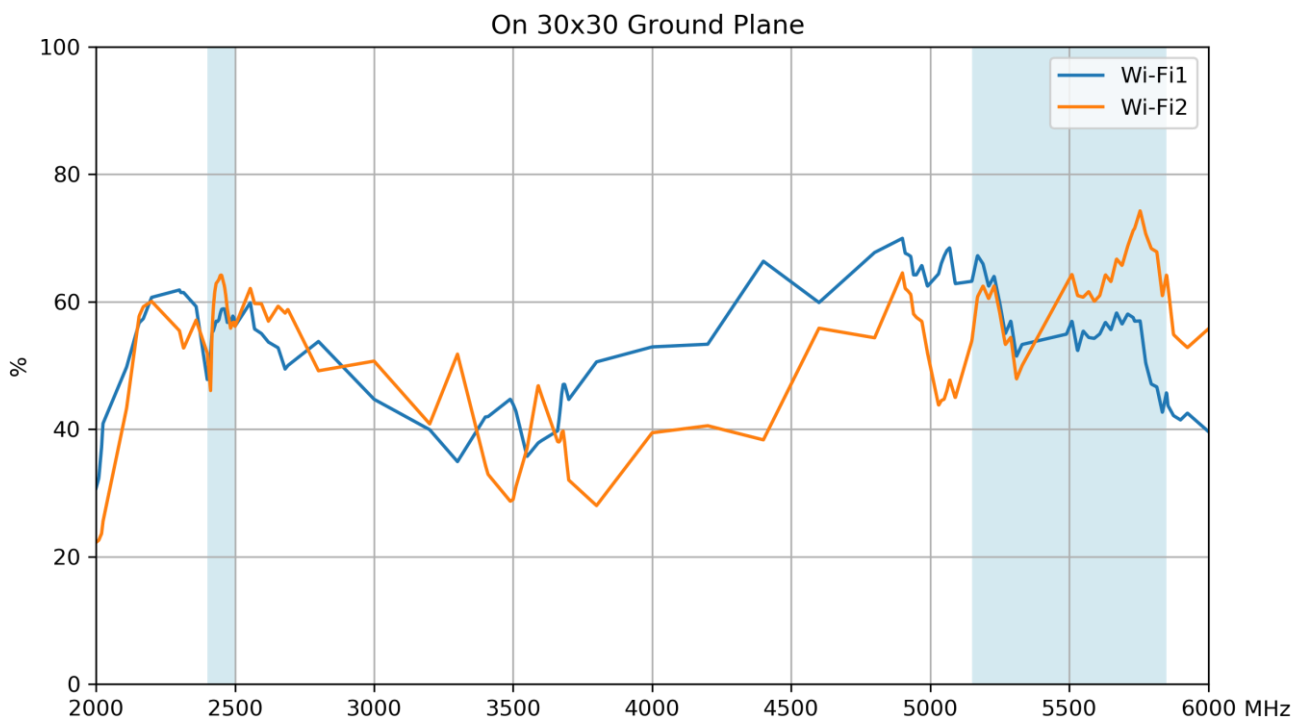

### 4.11 Average Gain - GNSS

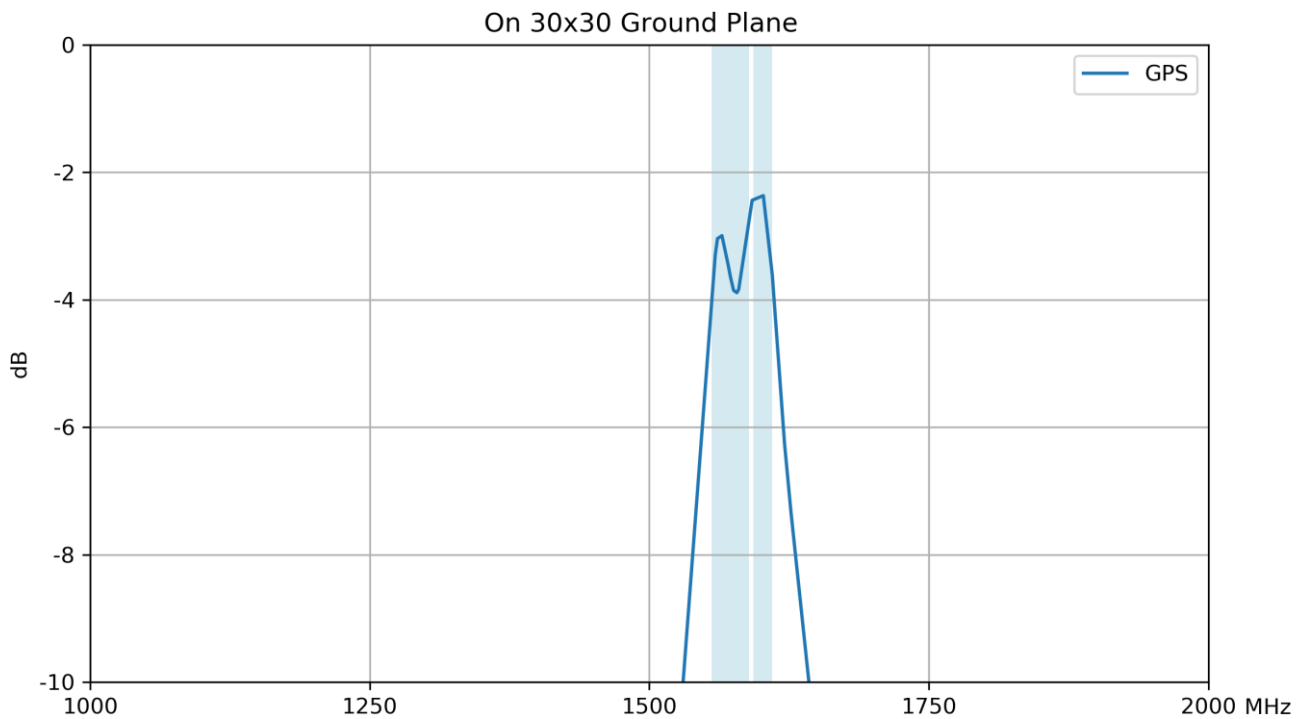

### 4.12 Average Gain – Cellular

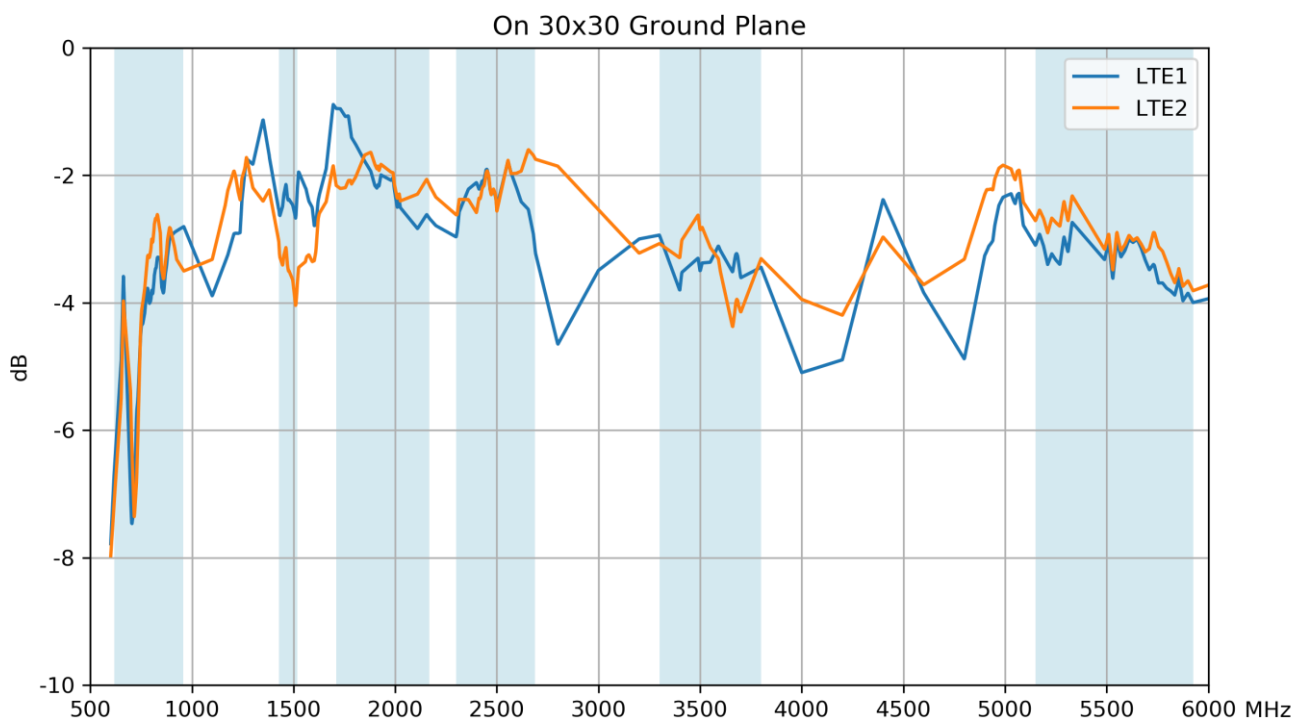

### 4.13 Average Gain – Wi-Fi

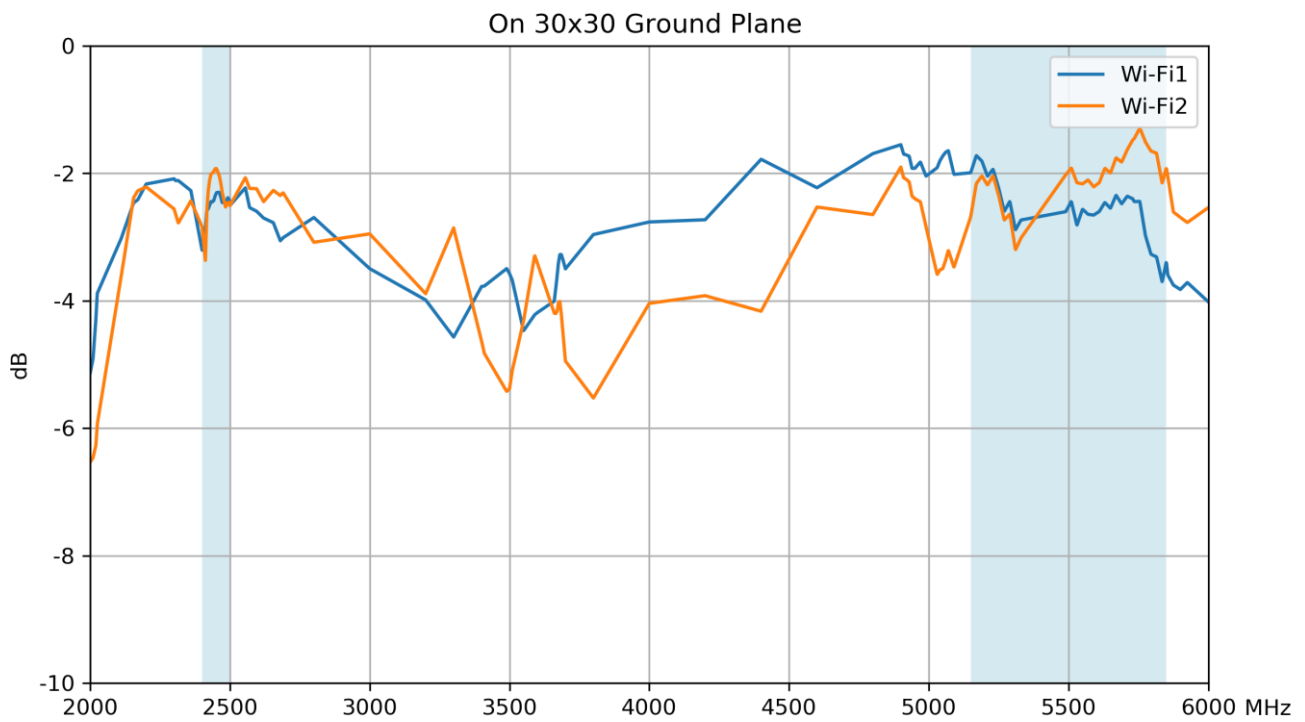

### 4.14 Peak Gain – GNSS

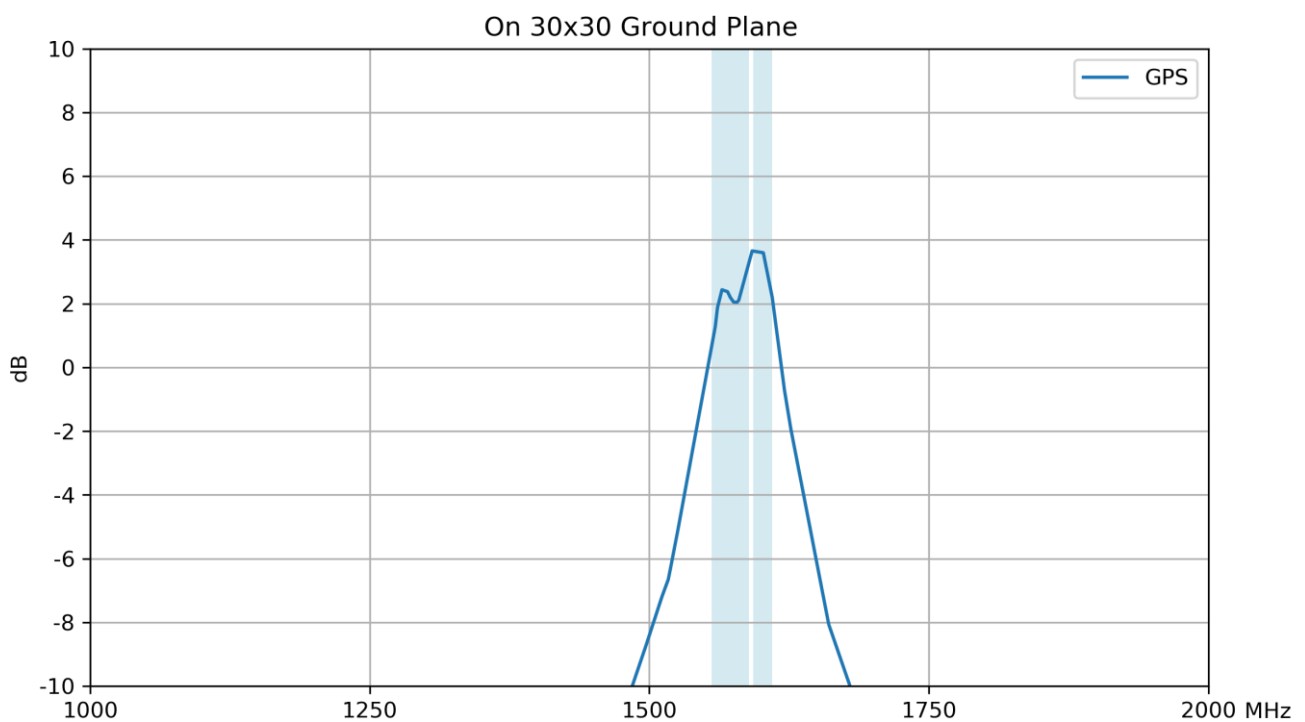

### 4.15 Peak Gain – Cellular

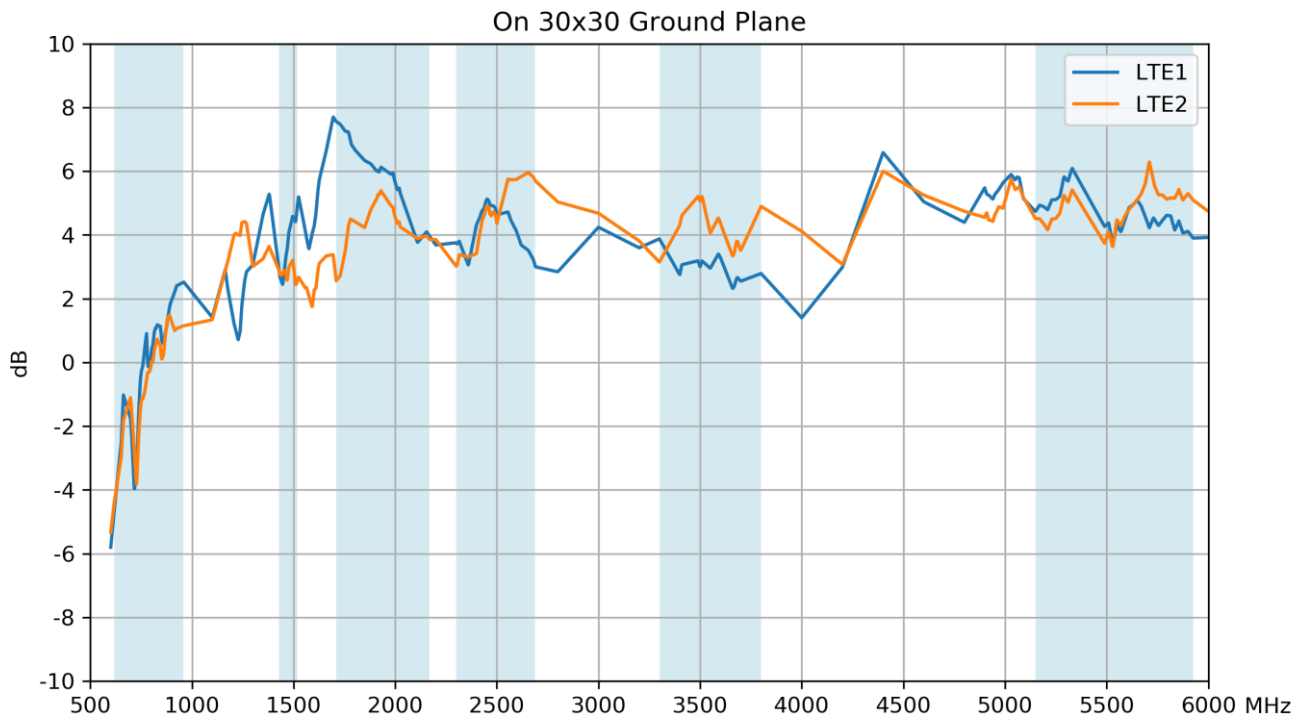

### 4.16 Peak Gain – Wi-Fi

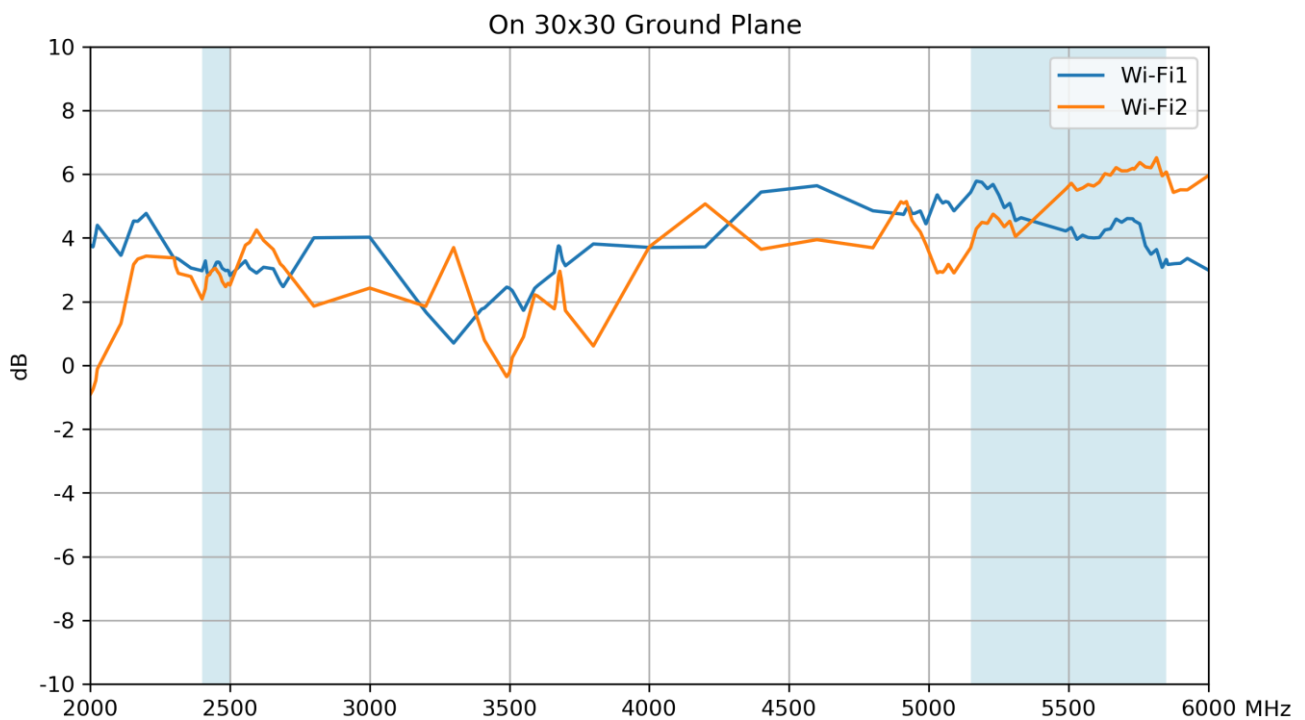

## 5. Radiation Patterns

### 5.1 Test Setup - 30\*30cm Ground Plane



## 5.2 GNSS 2D & 3D Radiation Patterns

1575MHz

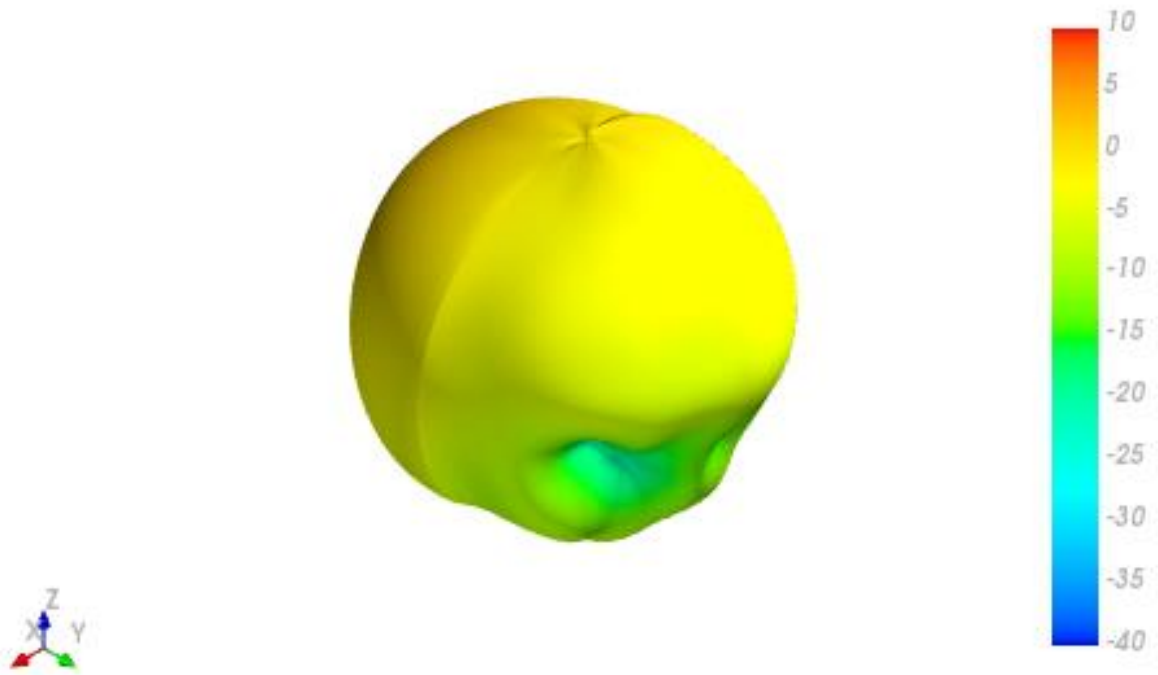

XY Plane

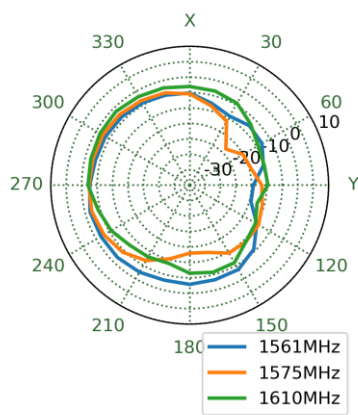

XZ Plane

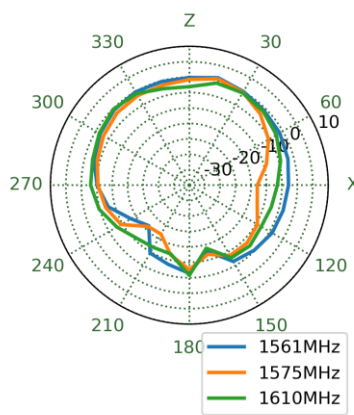

YZ Plane

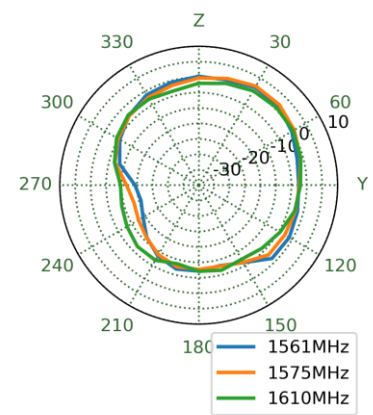

5.3 Cellular MIMO 1 2D & 3D Radiation Patterns

758MHz



XY Plane XZ Plane YZ Plane

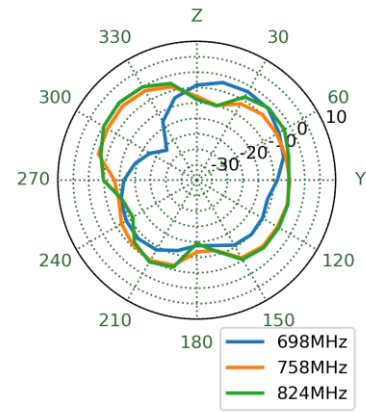
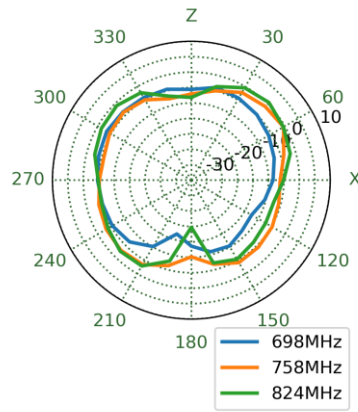
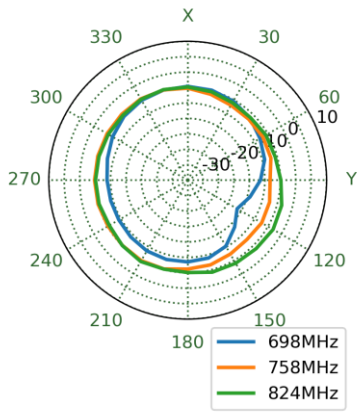

890MHz

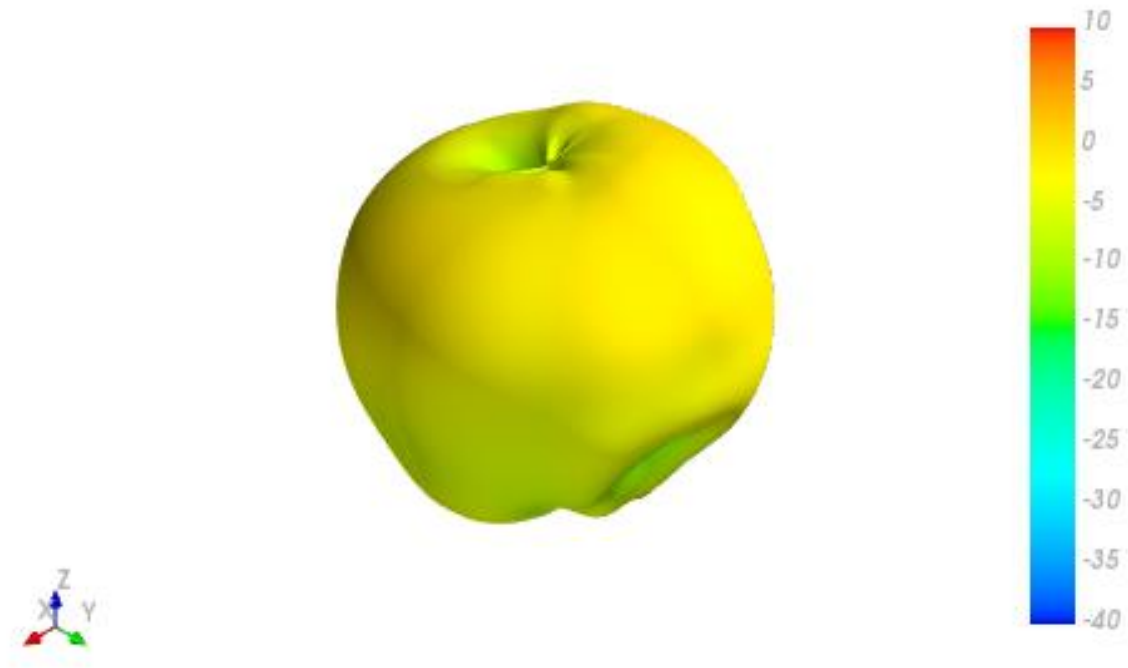

XY Plane XZ Plane YZ Plane

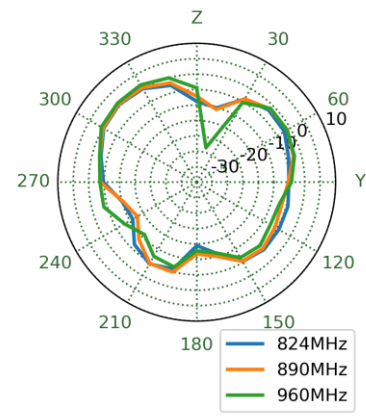
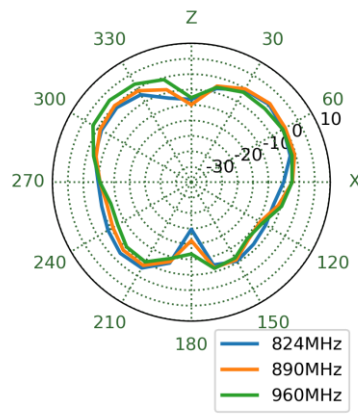
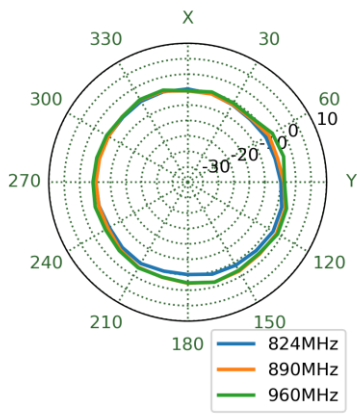

1805MHz

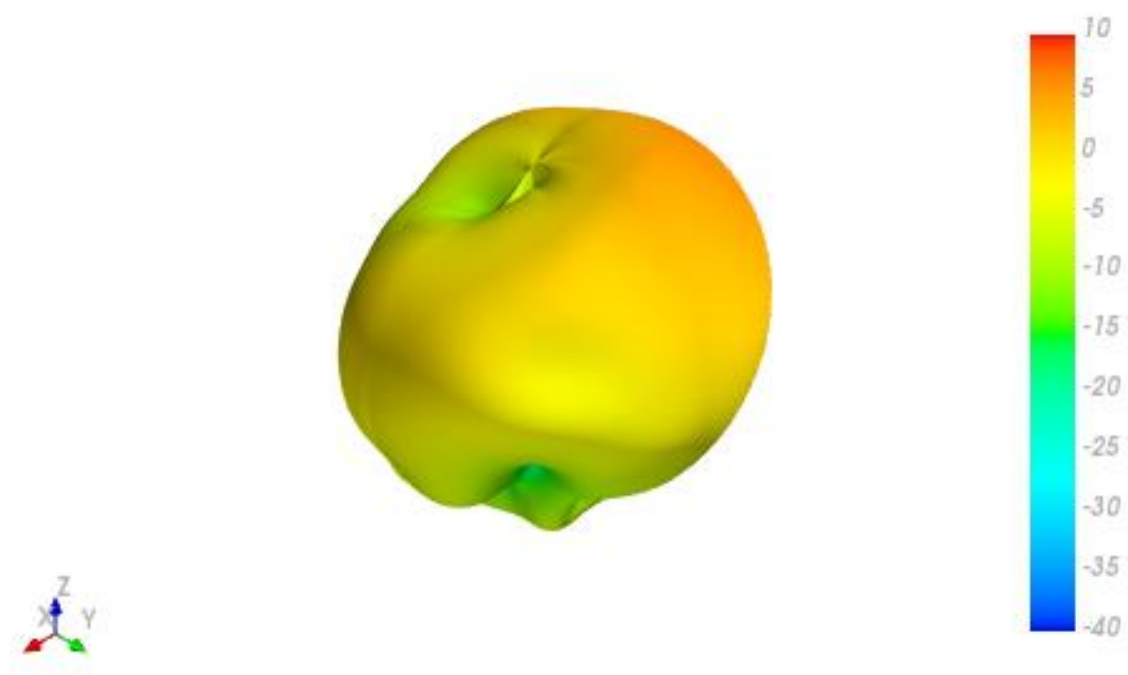

XY Plane XZ Plane YZ Plane

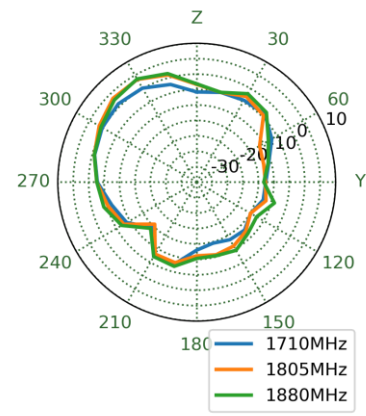
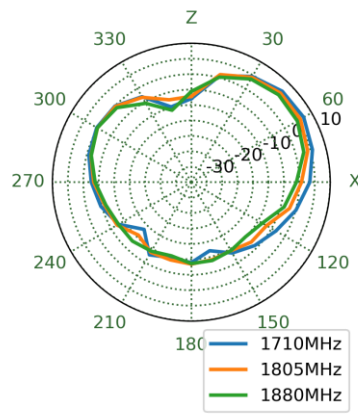
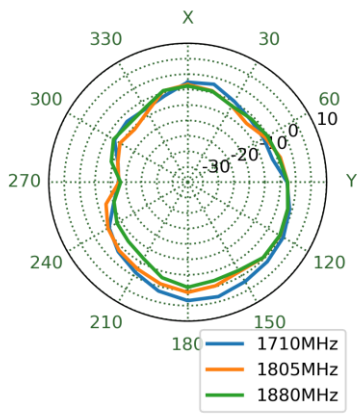

1920MHz

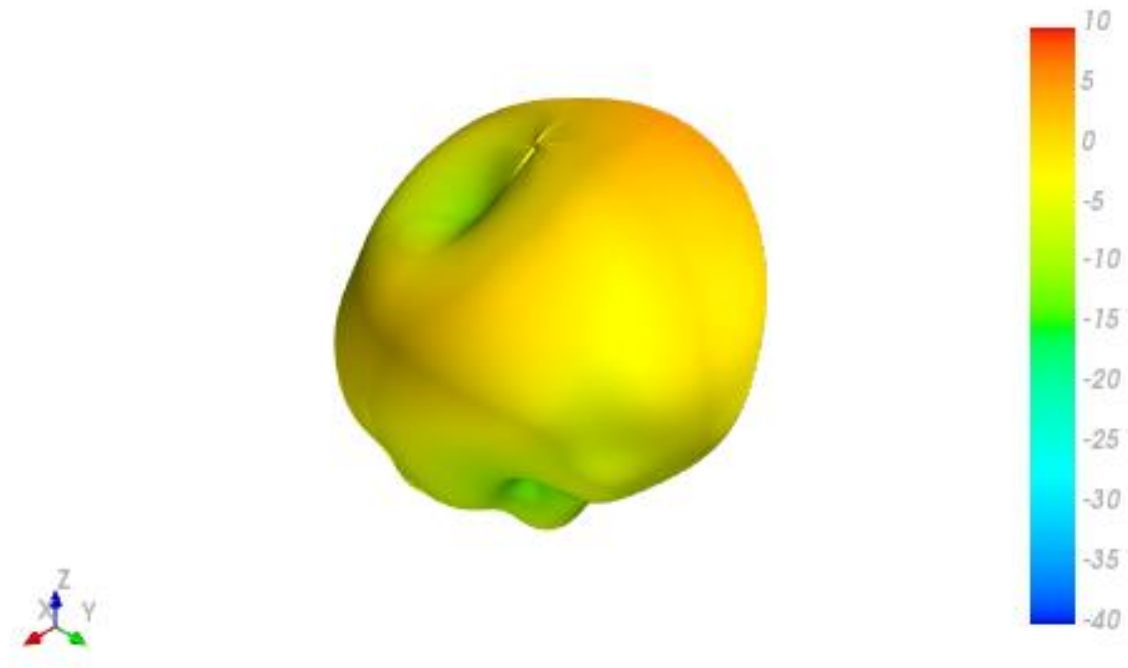

XY Plane XZ Plane YZ Plane

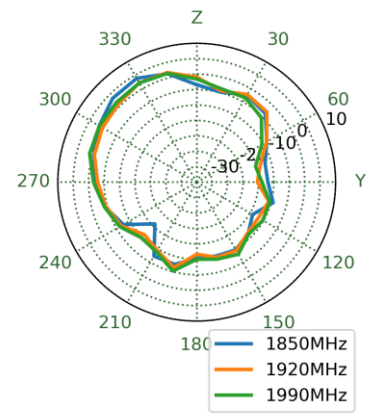
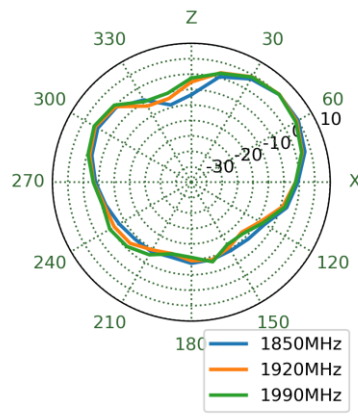
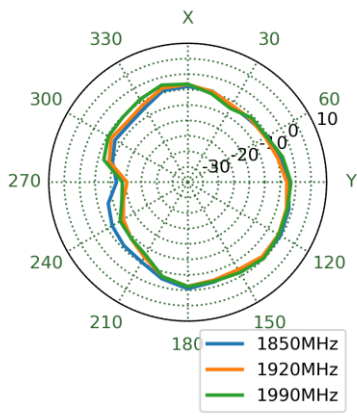

1990MHz

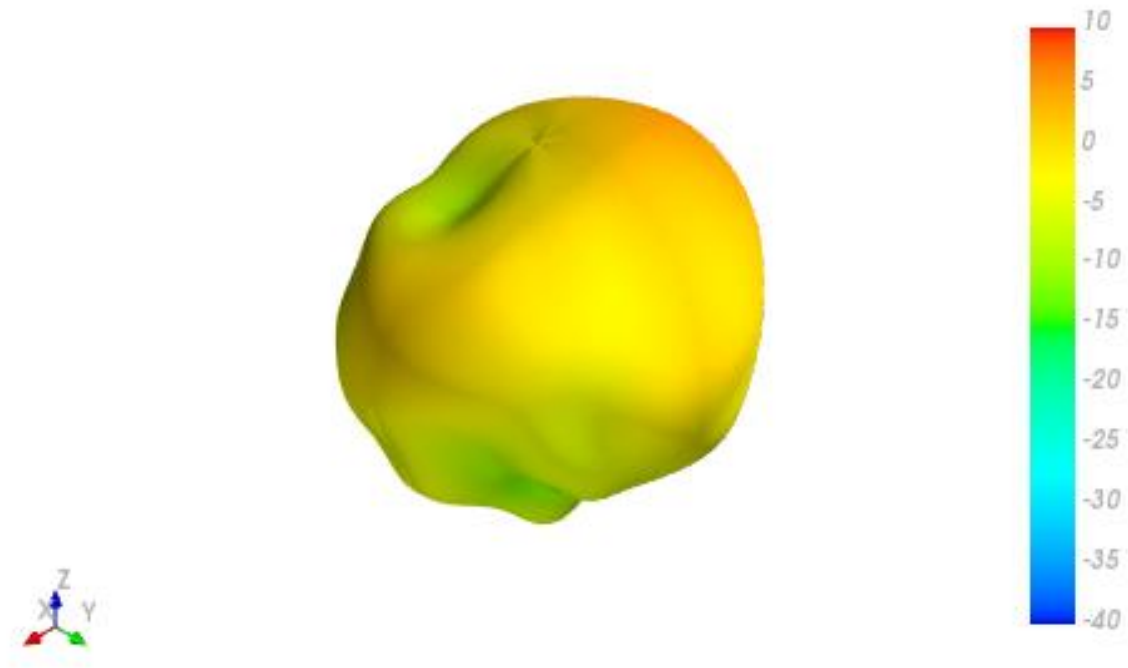

XY Plane XZ Plane YZ Plane

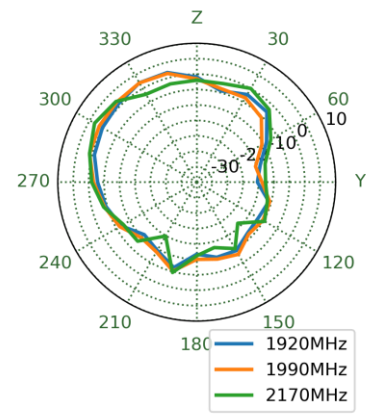
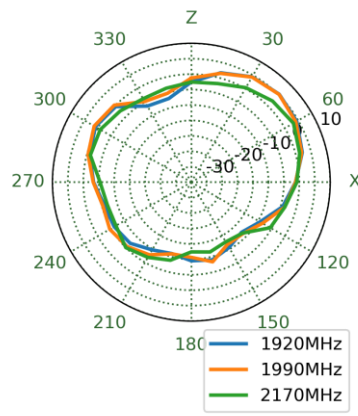
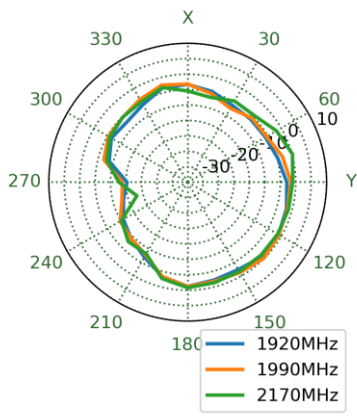

2500MHz

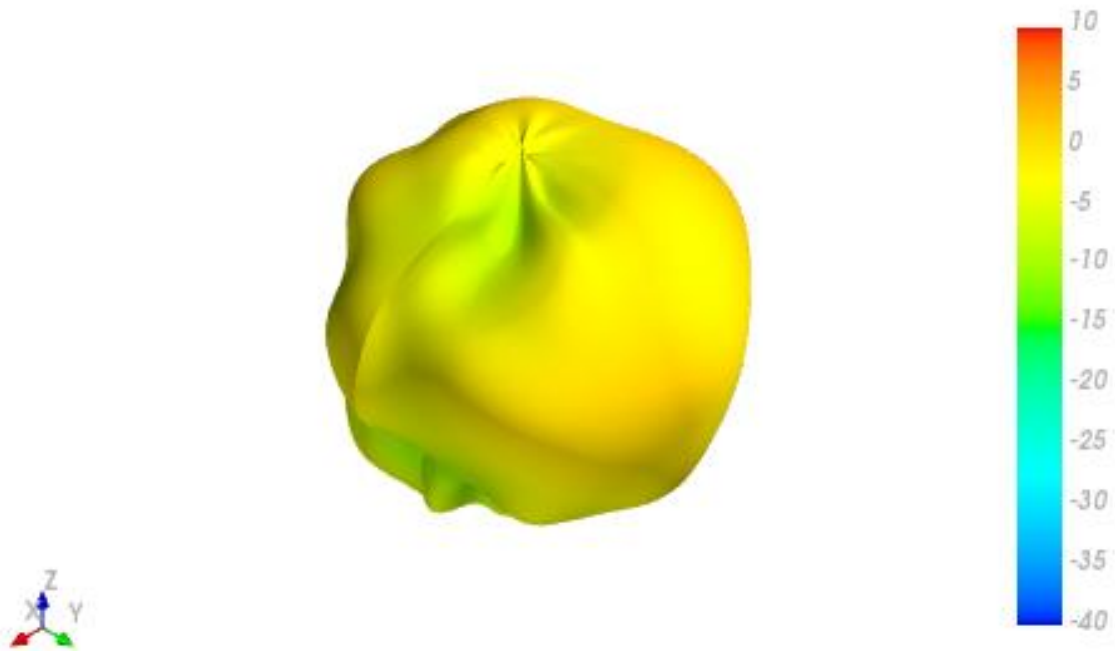

XY Plane XZ Plane YZ Plane

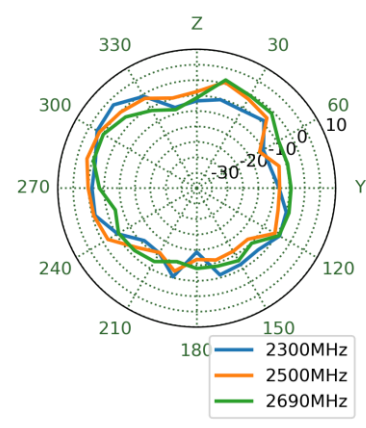
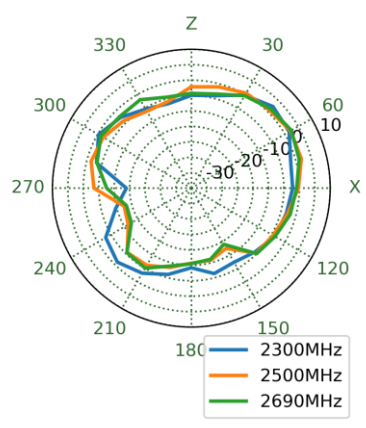
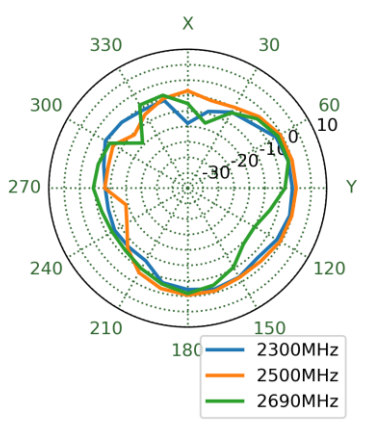

5.4 Cellular MIMO 2 2D & 3D Radiation Patterns

758MHz

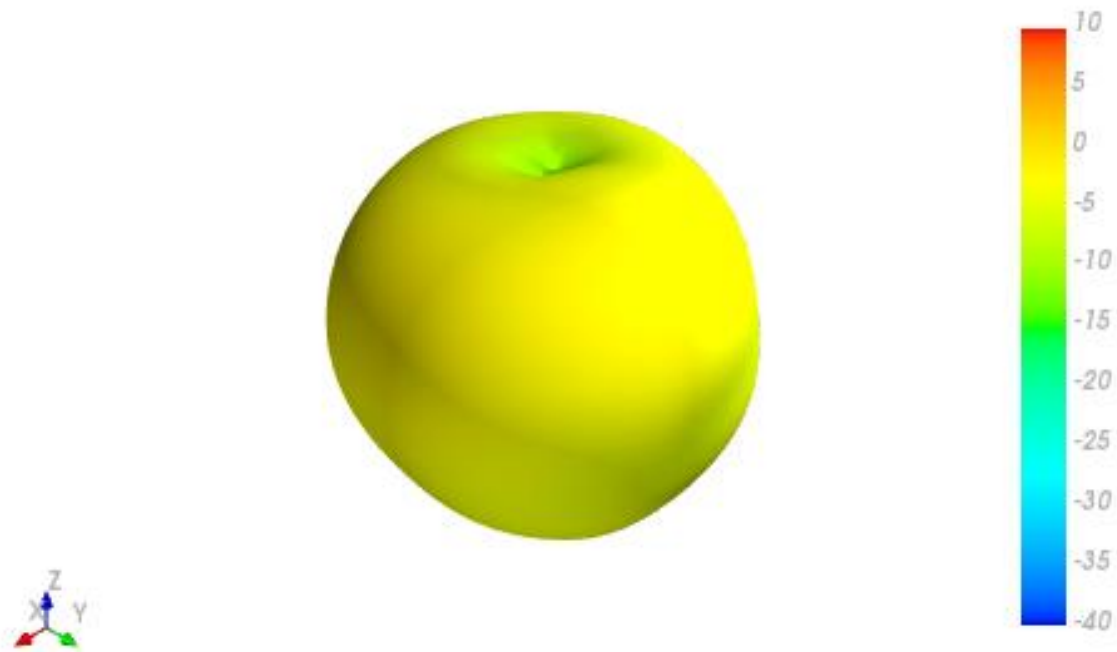

XY Plane

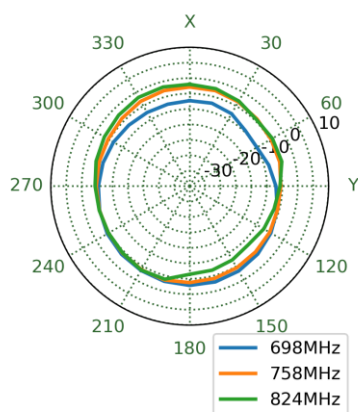

XZ Plane

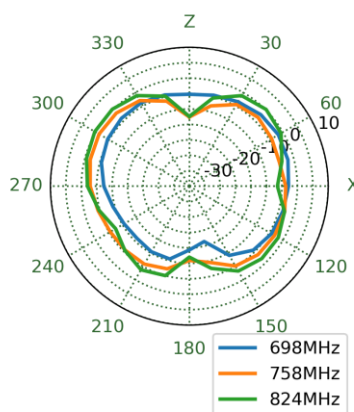

YZ Plane

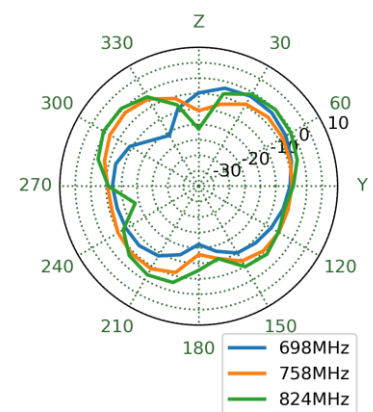

880MHz

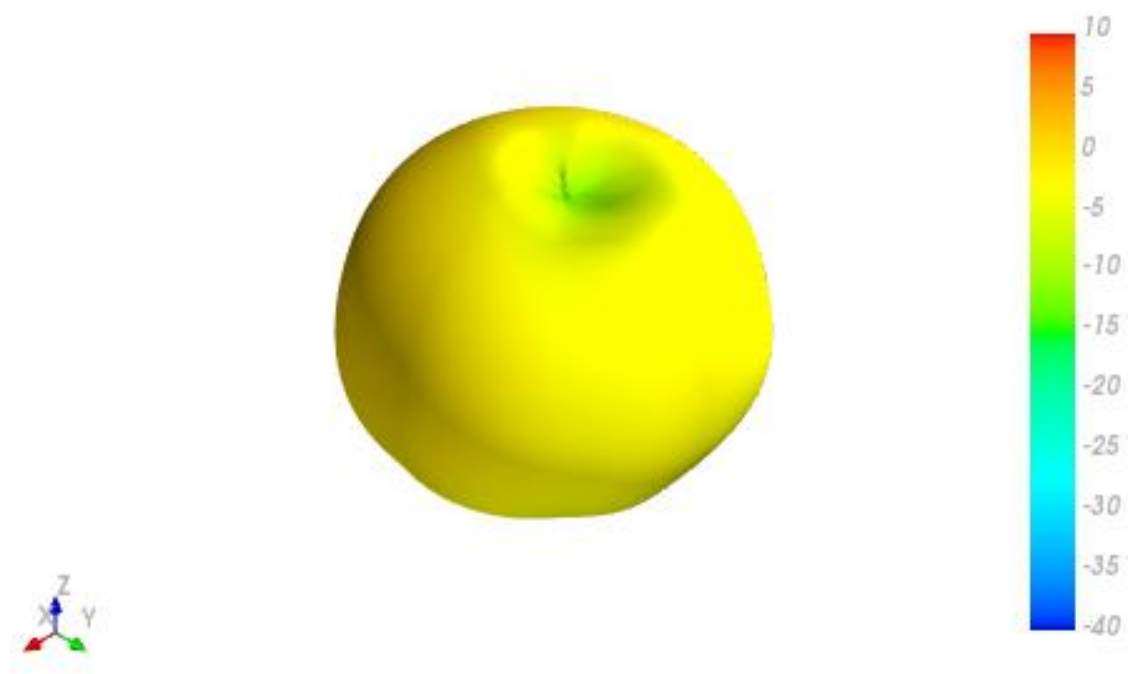

XY Plane XZ Plane YZ Plane

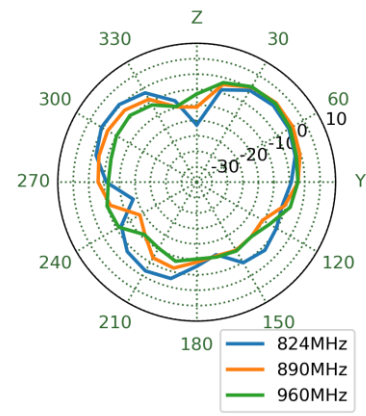
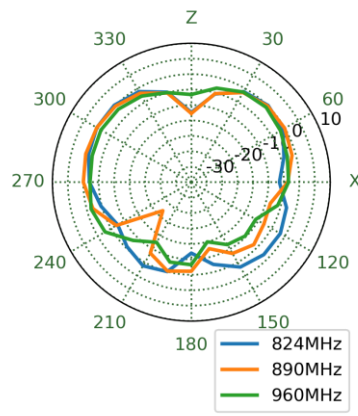
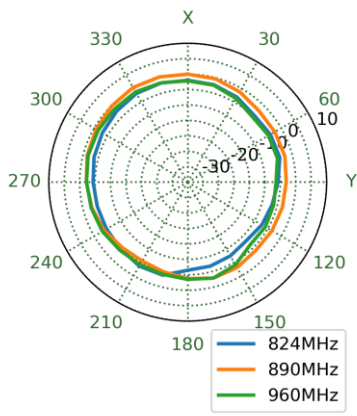

1805MHz

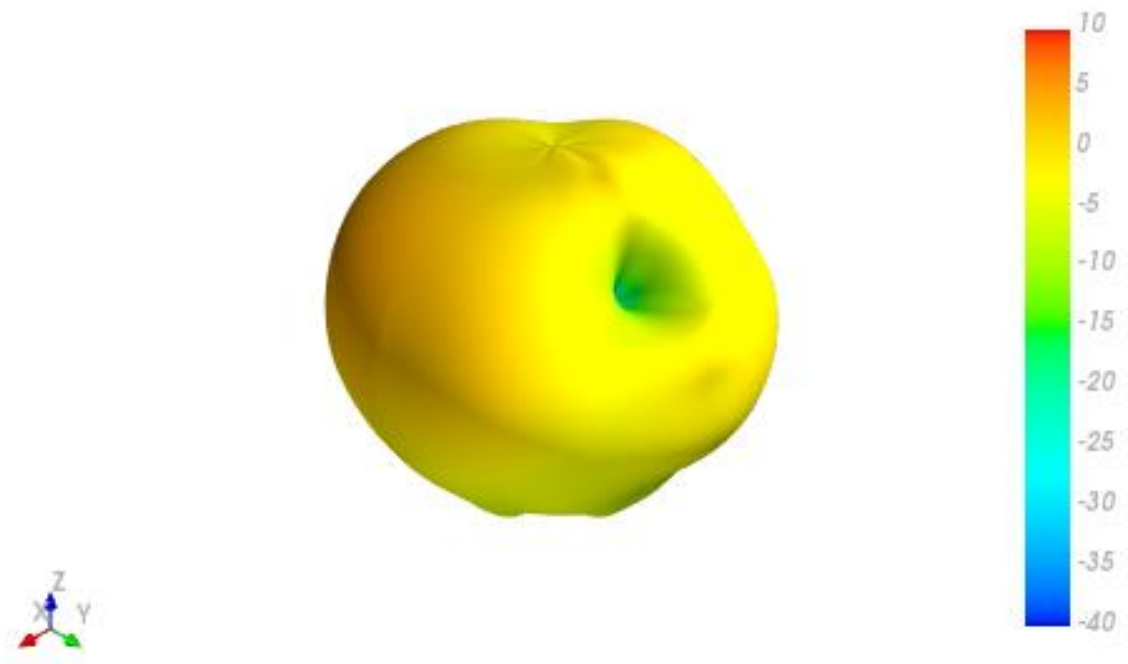

XY Plane XZ Plane YZ Plane

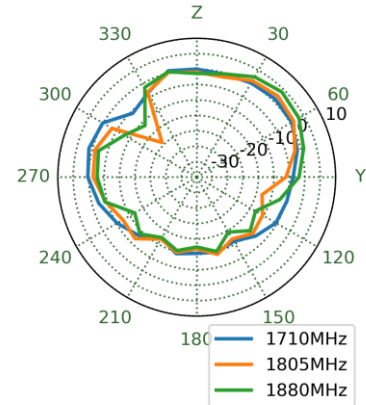
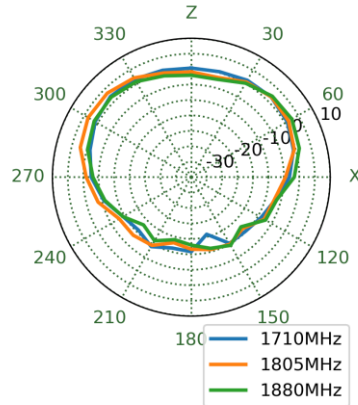
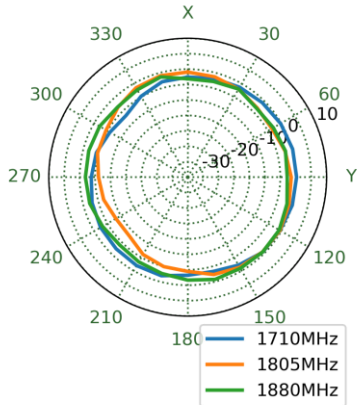

1920MHz

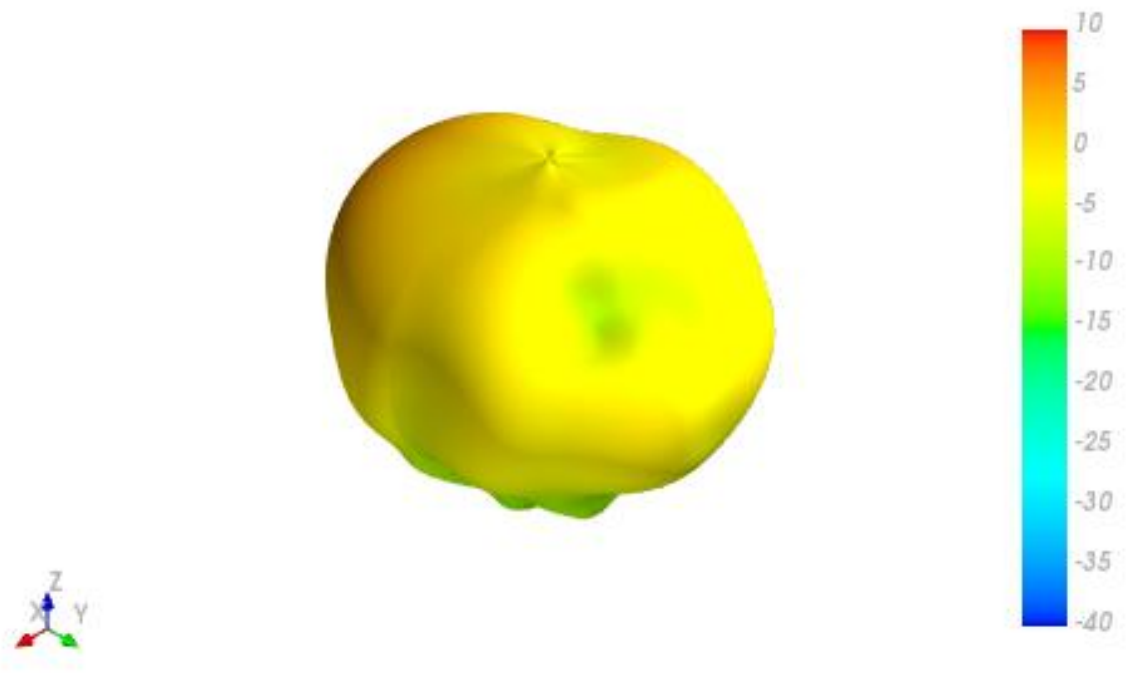

XY Plane XZ Plane YZ Plane

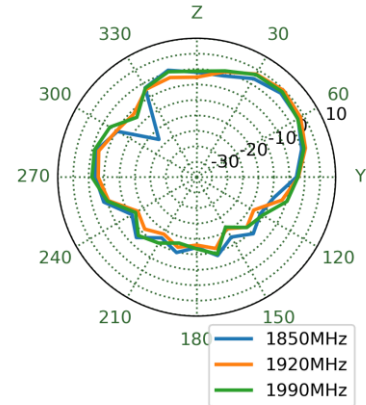
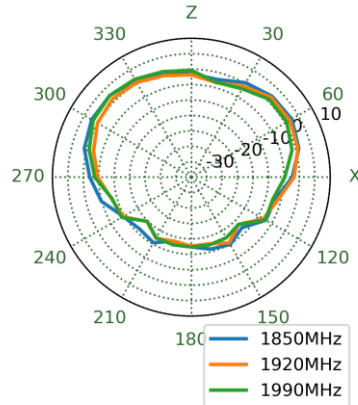
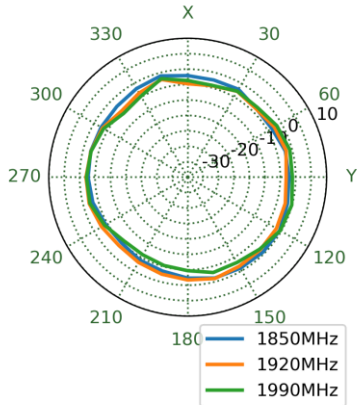

1990MHz

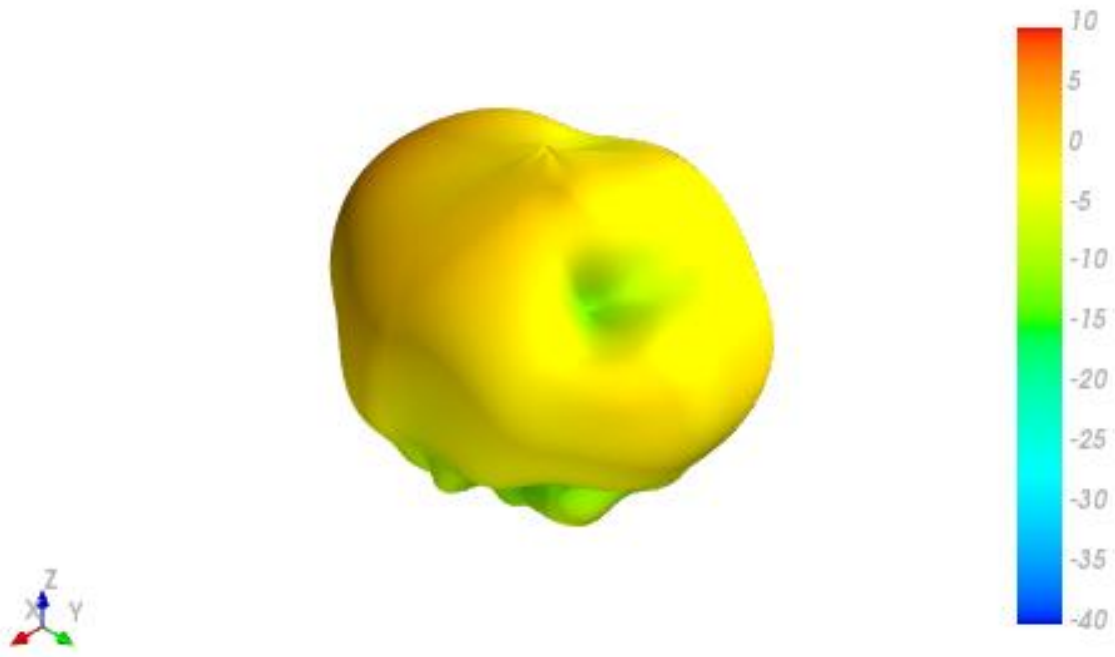

XY Plane XZ Plane YZ Plane

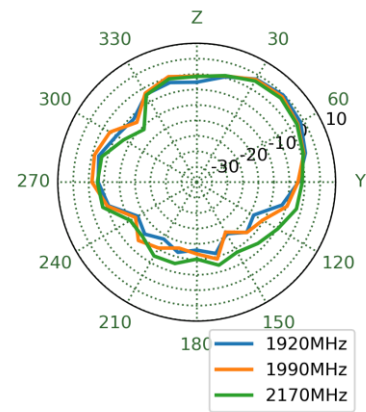
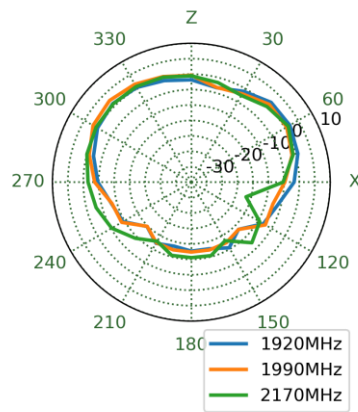
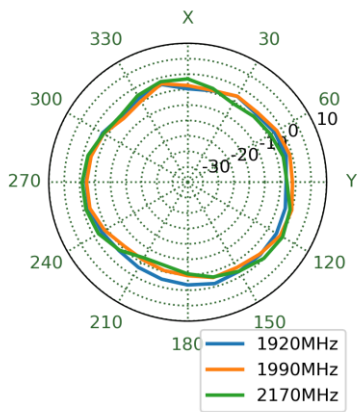

2500MHz

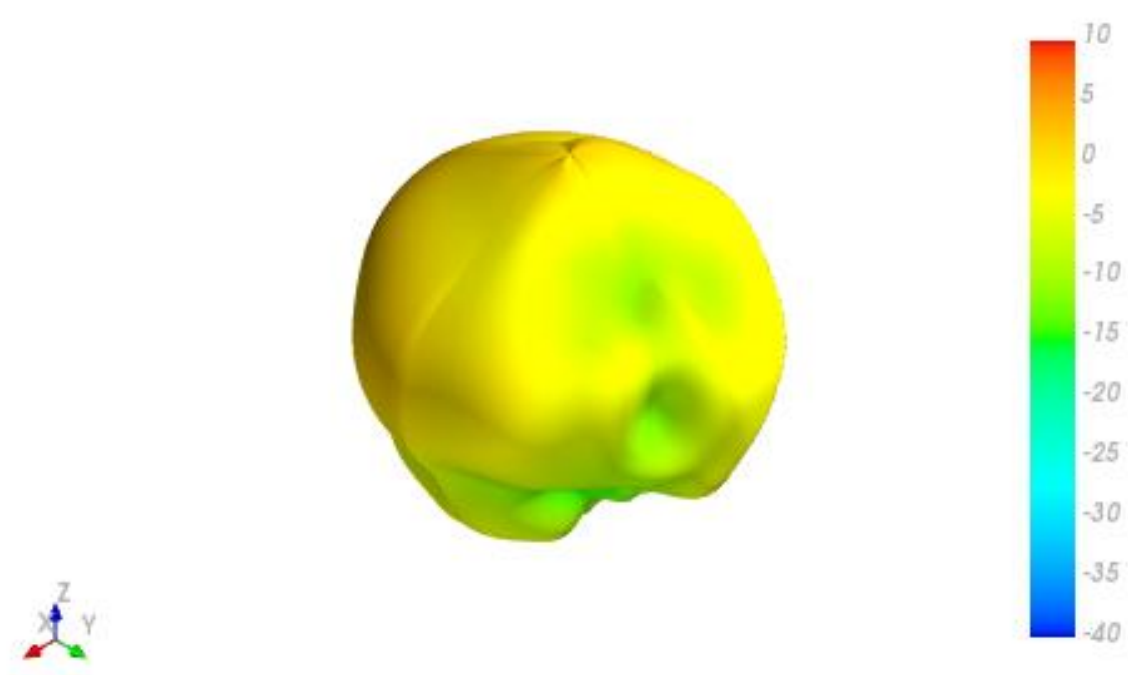

XY Plane XZ Plane YZ Plane

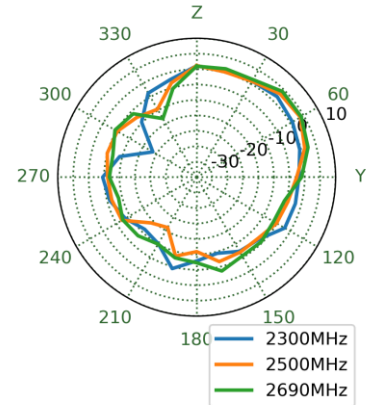
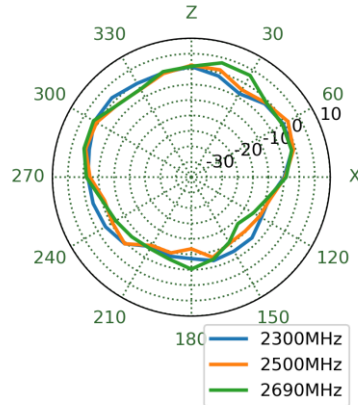
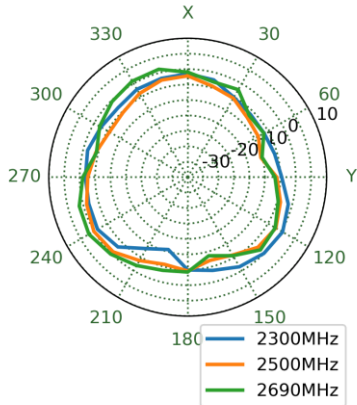

5.5 Wi-Fi MIMO 1 2D & 3D Radiation Patterns

2450MHz

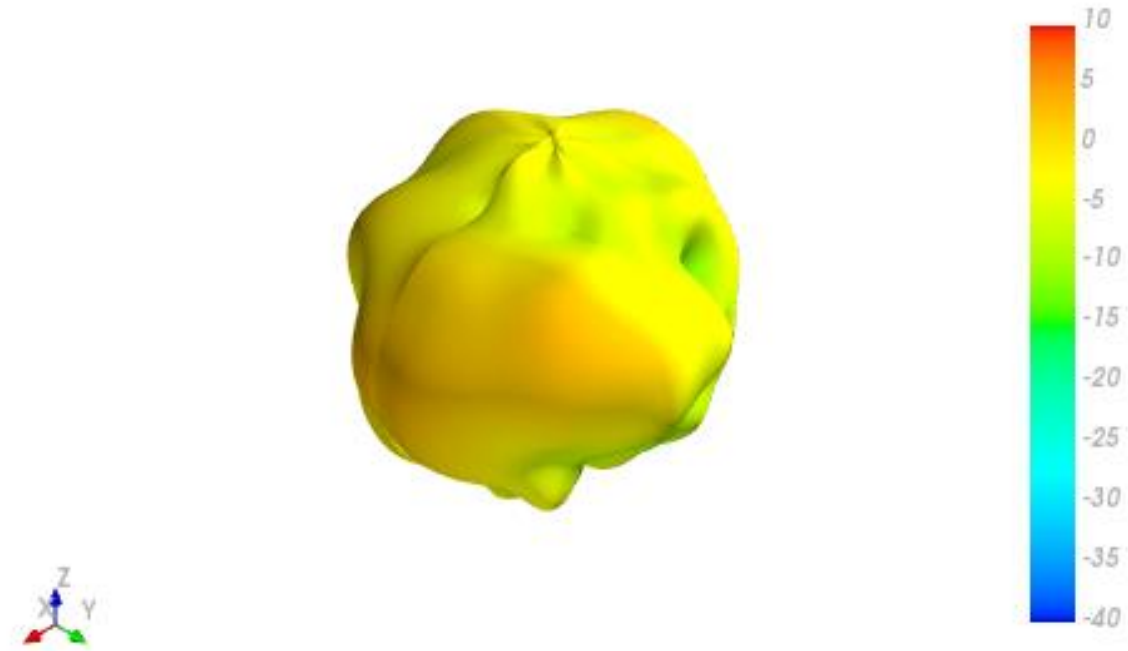

XY Plane XZ Plane YZ Plane

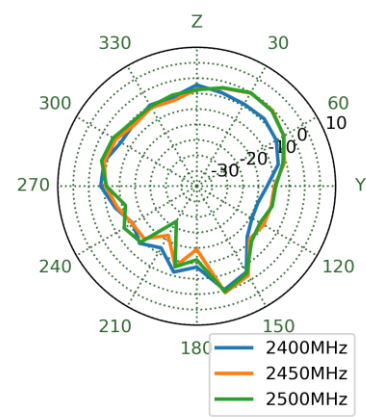
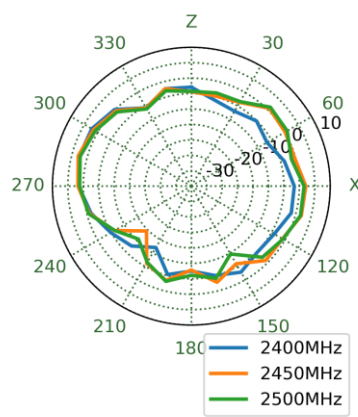
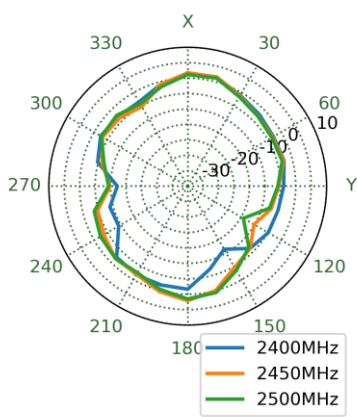

5550MHz

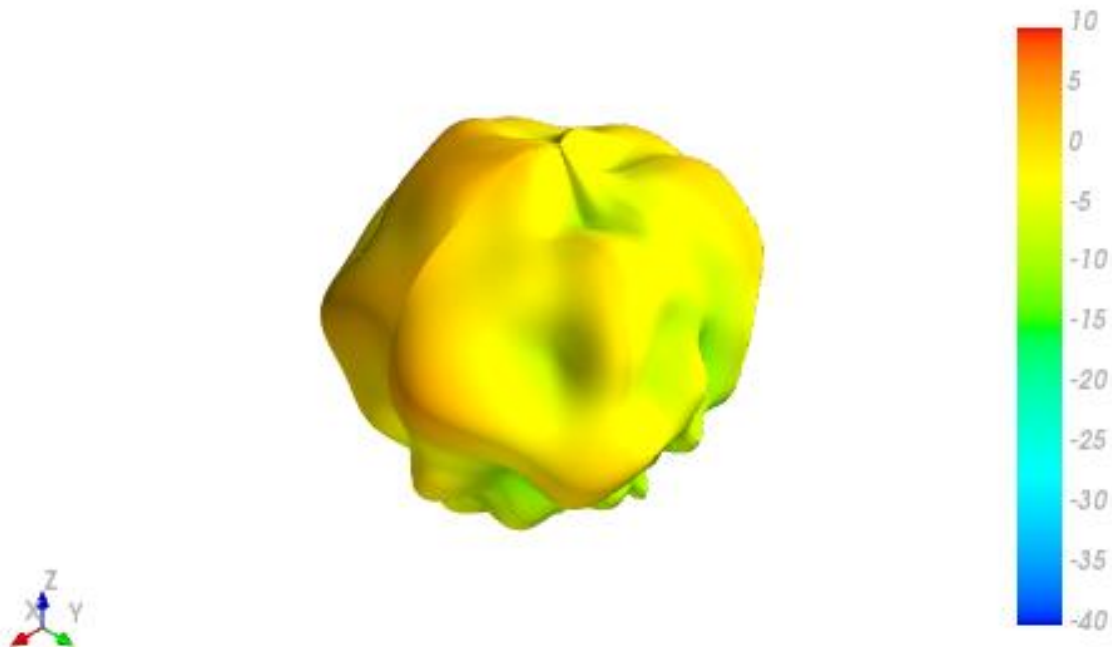

XY Plane XZ Plane YZ Plane

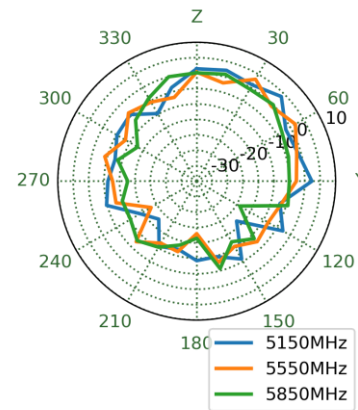
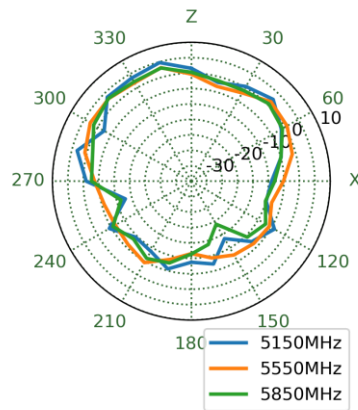
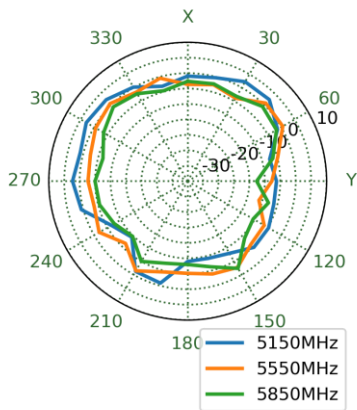

5.6 Wi-Fi MIMO 2 2D & 3D Radiation Patterns

2450MHz

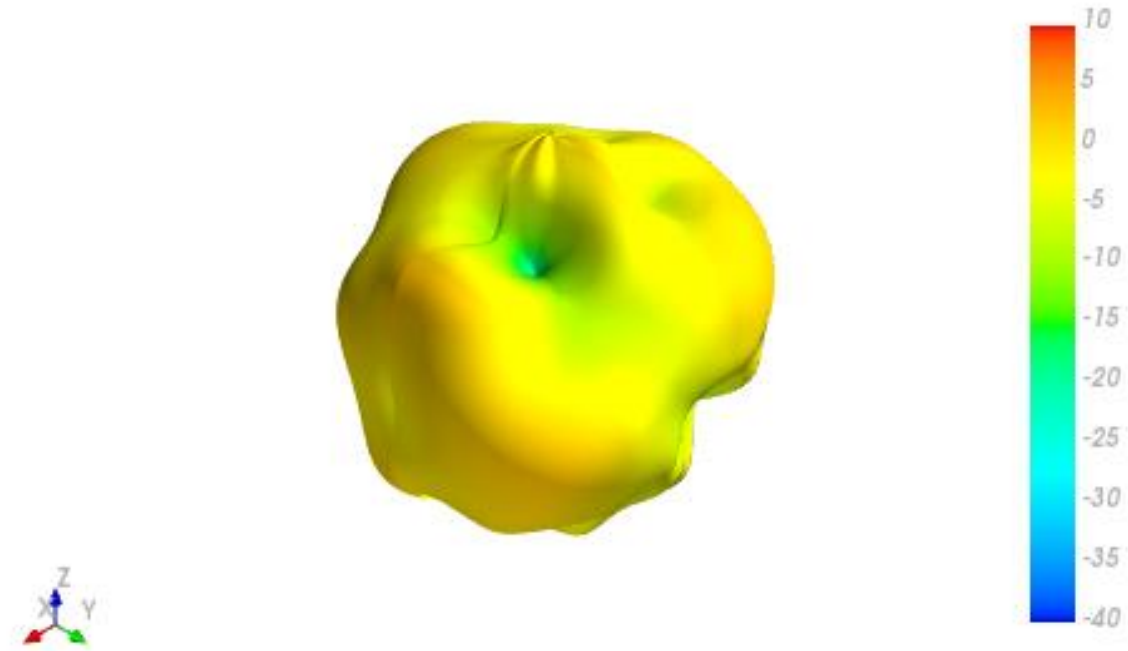

XY Plane XZ Plane YZ Plane

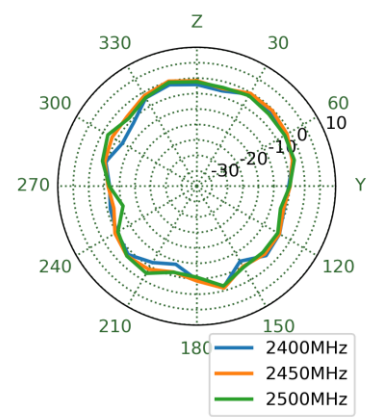
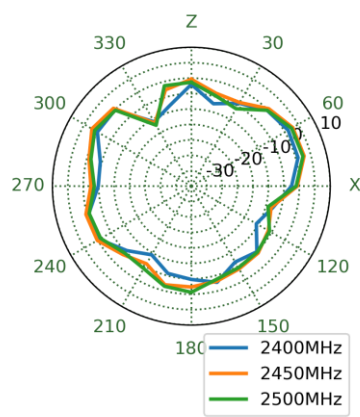
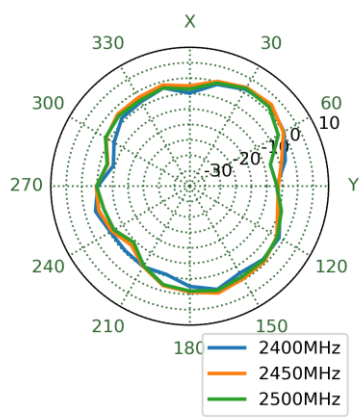

# 5550MHz

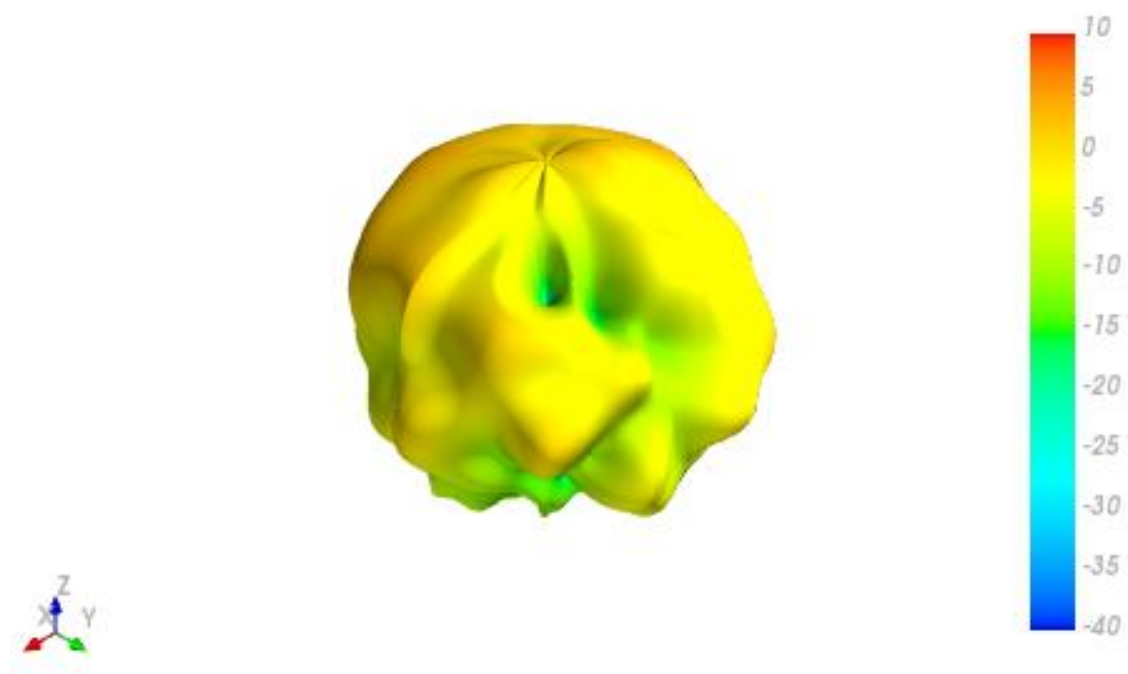

## XY Plane      XZ Plane      YZ Plane

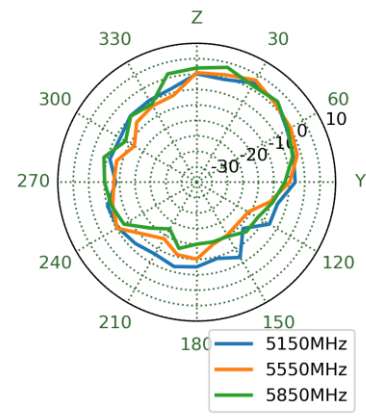
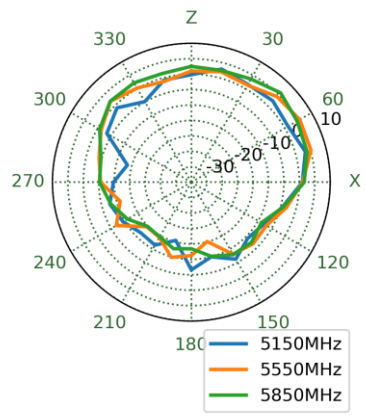
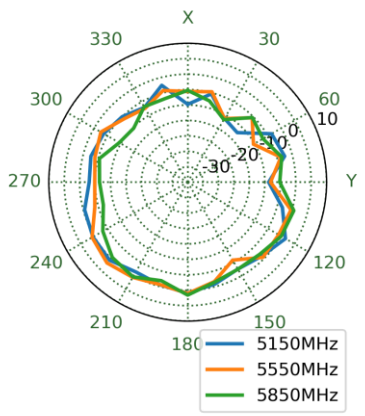

# 6. Mechanical Drawing (Units: mm)

ISO NO.: EDW.000937  
 STATE: Release  
 NOTES: 1. All models need to be confirmed.  
 2. Update 2 when REVISED & REWORKED

REV./AREA	DESCRIPTION	ENG.	APPROVED	DATE
01	Initial Design	Ruby	Aaron	2023/11/17
02	Update the total length to 3M	Ruby	Chenzen	2024/09/03

Whip Antenna-(174.18MHz):  
 700-500MHz Flexible Whip Antenna with M8 female connector

Whip Antenna-(174.18MHz):  
 700-500MHz Flexible Whip Antenna with M8 female connector

SM(M)ST Plug  
 Scale:2.5:1  
 1/4-36UNS-2B

M8 URF(M)ST Plug  
 Scale:2.5:1  
 3/8-24UNF-2B  
 Ø11.5±0.2

SM(M)ST Plug  
 Scale:2.5:1  
 1/4-36UNS-2B

RP-SM(M)ST Plug  
 Scale:2.5:1  
 1/4-36UNS-2B

Detail E  
 Scale:2:1

Approved By: Aaron  
 Design By: Ruby  
 DATE: 2023/11/17  
 TITLE: 7m Rubber 3000mm (M1290ALBCGR1.002) with staggered cable assembly and braid  
 PART NO.: M1290.K.LBCGR1.001  
 UNIT: mm  
 SCALE: 1:2.5  
 PAGES: 1/1  
 D02

No.	Rev.	Author	Check	Drawn	By	Part	Rev.
1	01	Ruby	Aaron	Ruby	Ruby	M1290ALBCGR1.002	1
2	01	Ruby	Aaron	Ruby	Ruby	M1290ALBCGR1.002	1
3	01	Ruby	Aaron	Ruby	Ruby	M1290ALBCGR1.002	1
4	01	Ruby	Aaron	Ruby	Ruby	M1290ALBCGR1.002	1
5	01	Ruby	Aaron	Ruby	Ruby	M1290ALBCGR1.002	1
6	01	Ruby	Aaron	Ruby	Ruby	M1290ALBCGR1.002	1
7	01	Ruby	Aaron	Ruby	Ruby	M1290ALBCGR1.002	1
8	01	Ruby	Aaron	Ruby	Ruby	M1290ALBCGR1.002	1
9	01	Ruby	Aaron	Ruby	Ruby	M1290ALBCGR1.002	1
10	01	Ruby	Aaron	Ruby	Ruby	M1290ALBCGR1.002	1
11	01	Ruby	Aaron	Ruby	Ruby	M1290ALBCGR1.002	1
12	01	Ruby	Aaron	Ruby	Ruby	M1290ALBCGR1.002	1
13	01	Ruby	Aaron	Ruby	Ruby	M1290ALBCGR1.002	1
14	01	Ruby	Aaron	Ruby	Ruby	M1290ALBCGR1.002	1
15	01	Ruby	Aaron	Ruby	Ruby	M1290ALBCGR1.002	1
16	01	Ruby	Aaron	Ruby	Ruby	M1290ALBCGR1.002	1
17	01	Ruby	Aaron	Ruby	Ruby	M1290ALBCGR1.002	1
18	01	Ruby	Aaron	Ruby	Ruby	M1290ALBCGR1.002	1
19	01	Ruby	Aaron	Ruby	Ruby	M1290ALBCGR1.002	1
20	01	Ruby	Aaron	Ruby	Ruby	M1290ALBCGR1.002	1
21	01	Ruby	Aaron	Ruby	Ruby	M1290ALBCGR1.002	1
22	01	Ruby	Aaron	Ruby	Ruby	M1290ALBCGR1.002	1
23	01	Ruby	Aaron	Ruby	Ruby	M1290ALBCGR1.002	1
24	01	Ruby	Aaron	Ruby	Ruby	M1290ALBCGR1.002	1
25	01	Ruby	Aaron	Ruby	Ruby	M1290ALBCGR1.002	1
26	01	Ruby	Aaron	Ruby	Ruby	M1290ALBCGR1.002	1
27	01	Ruby	Aaron	Ruby	Ruby	M1290ALBCGR1.002	1
28	01	Ruby	Aaron	Ruby	Ruby	M1290ALBCGR1.002	1
29	01	Ruby	Aaron	Ruby	Ruby	M1290ALBCGR1.002	1
30	01	Ruby	Aaron	Ruby	Ruby	M1290ALBCGR1.002	1

## 7. Packaging

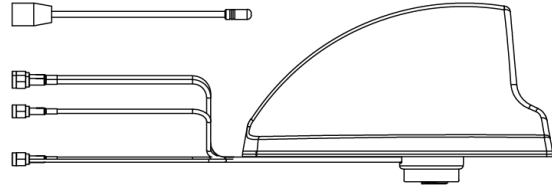

1pc MA1290.A.LBICGRT.005 per PE Bag  
Weight: 972.5g

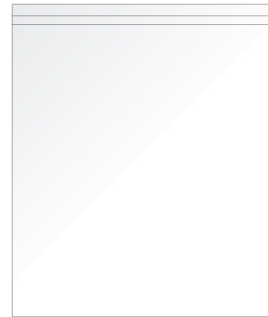

12pcs MA1290.A.LBICGRT.001 per Inner Trays

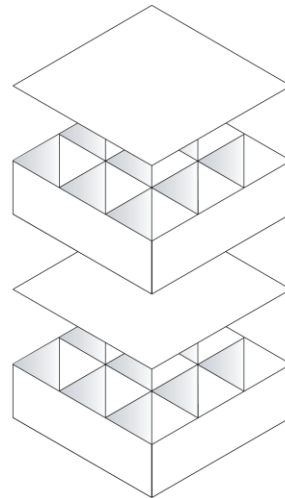

12pcs MA1290.A.LBICGRT.001 per Carton  
Dimensions: 506\*490\*250mm  
Weight: 11.67Kg

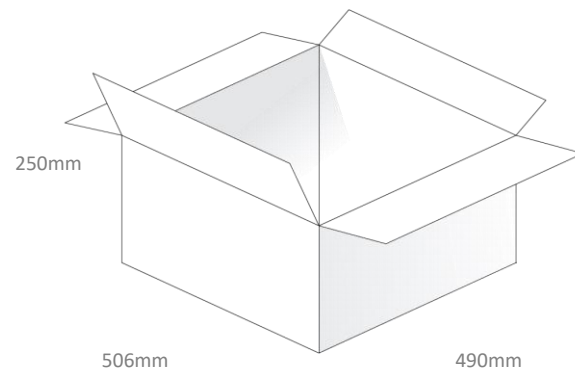

## 8. Installation

# Installation Instructions

## Raptor III Series

### 7-in-1 Permanent Mount Combination Antenna



#### A Introduction

The Taoglas Raptor III is an external combination antenna designed for mounting on the roof of a vehicle. The Raptor III can accommodate a combination of up to 7 antennas in one sleek housing. One 22mm(0.86") hole is required when installing this antenna. The cables are fed through this hole and secures the antenna to the surface with nut and washer.

The Raptor III is IP67 waterproof rated and includes a rubber base to provide a seal against water ingress.



#### Electrical Safety

The Raptor III MA1280 contains an active GPS/GNSS antenna.  
Rated voltage: 3-5VDC Rated current: 24mA maximum

**The supply to this device must be provided with over-current protection of 1A maximum.**

**Power consumption@1.8V (mA) 4.5 mA**

**Power consumption@3.0V (mA) 10 mA**

**Power consumption@5.5V (mA) 24 mA**

#### B Mounting & Location

The Raptor III can be mounted on any surface, without the need for a ground plane. When mounting on a vehicle roof panel ensure to mount on a flat surface. When mounting the Raptor III, it should be placed as far as possible away from other roof-mounted features such as the aircon unit, light bar etc.



#### Sealing

In order to ensure that the installation is sealed against the mounting surface care must be taken regarding curvature of the mounting panel. It is highly recommended to install the antenna on a clean, flat and level surface. After installation the compression of the rubber boot against the mounting panel should be checked and a small bead of neutral cure silicone sealant can be applied around the periphery of the base of the antenna if required.

Mount on a flat surface

#### C Mounting Hole

When preparing to drill the hole, mask the area around the hole position to protect the surface. Drill a pilot hole through the panel and increase the hole size to 22mm(0.86") diameter. Ensure the drill bit does not contact the headliner. Deburr and clean the area around the hole carefully removing all waste. Remove paint and primer from under panel surface to ensure adequate earth contact by washer and nut. Apply petroleum jelly or paint around cut edge of the hole to prevent corrosion



## D Installation of the Antenna

Feed the cables and thread through the hole. Position the antenna over the hole and press down onto the panel with pressure. A plastic washer with a slot for cable routing is added first followed by a split nut(M20). These provide options for vertical or horizontal cable routing. Secure the antenna in place by attaching the nut from the underside of the panel, only a final tighten by spanner is required.

Recommended Mounting Torque: 5N-m

## E Routing and Connection of the Cables

The Cables supplied in a braided assembly for ease of installation. A power cable, colored red, is also supplied for powering the AM/FM. The heatshrink will denote which cable is which for ease of installation. Connect each individual connector to the correct port of the device, if any cable is unused please fit a 50Ω terminator to the individual connection.

## G Notices



### Caution

To comply with FCC RF Exposure requirements in section 1.1310 of the FCC Rules, antennas used with this device must be installed to provide a separation distance of at least 20 cm from all persons to satisfy RF exposure compliance.



### Warning

**Do not** Operate the transmitter when someone is within 20 cm of the antenna.  
**Do not** operate the equipment in an explosive atmosphere.



### European Waste Electronic Equipment Directive 2002/96/EC

Please ensure that your old Waste Electricals and Electronics are recycled do not throw them away into standard waste.



### Directive 2014/53/EU Radio Equipment Directive (RED)

#### Harmonised Standards and References:

**EN 301 489-1 (V2.2.1)**: ElectroMagnetic Compatibility (EMC) standard for radio equipment and services; Part 1: Common technical requirements. Referencing CENELEC EN 55032 Class B.

**Waiver:** This document represents information compiled by Taoglas to the best of our current knowledge. This is not intended to be used as a representation or warranty of fitness of the products described for any particular purpose. This document details guidelines for general information purposes only. When planning installations, always seek specialist advice and ensure that the products are always installed by a properly qualified installer in accordance with applicable regional laws and regulations.



## 9. Application Note

The MA1290 antenna GPS, Cellular & Wi-Fi performance with different cable lengths is shown below.

### 9.1 Return Loss

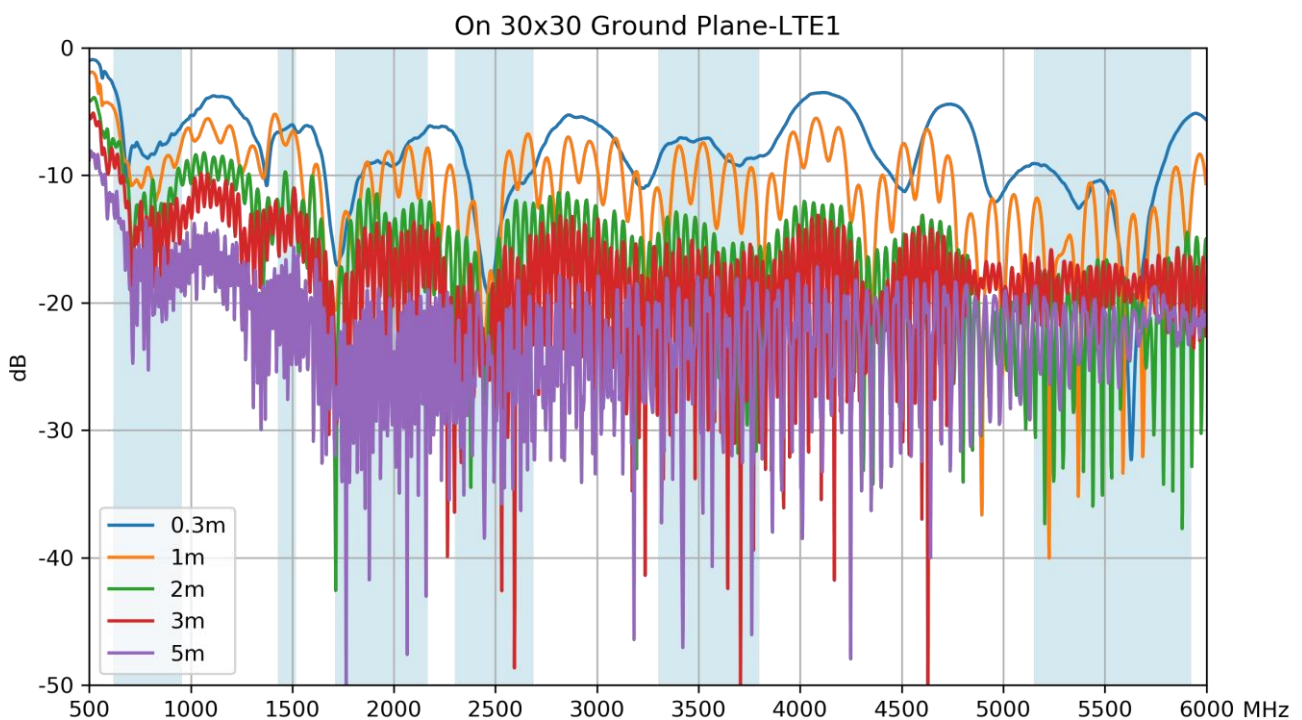
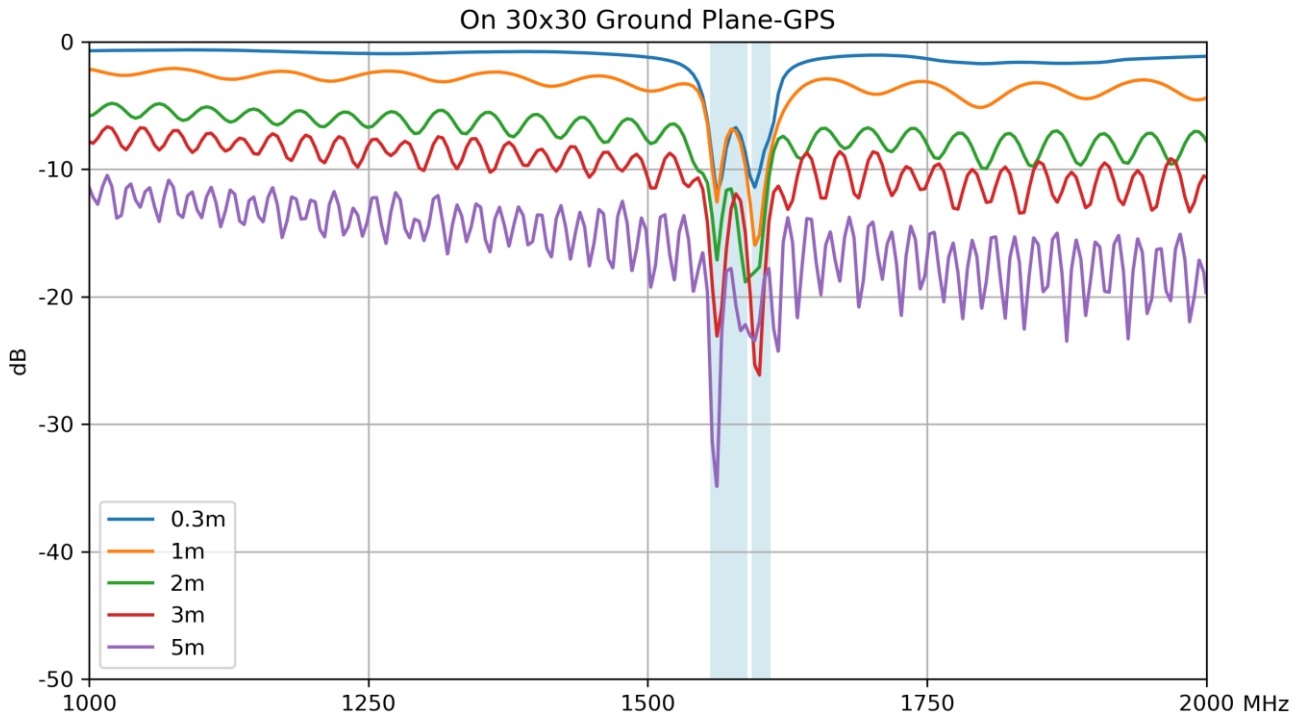

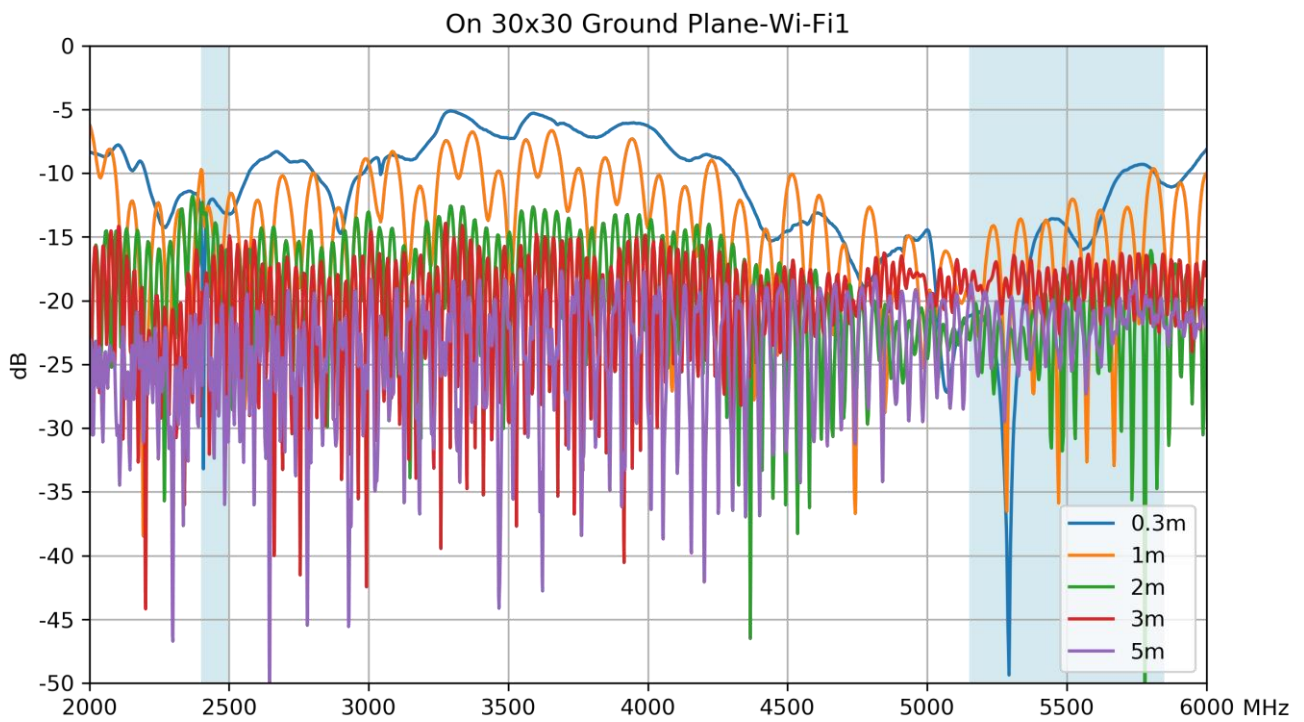
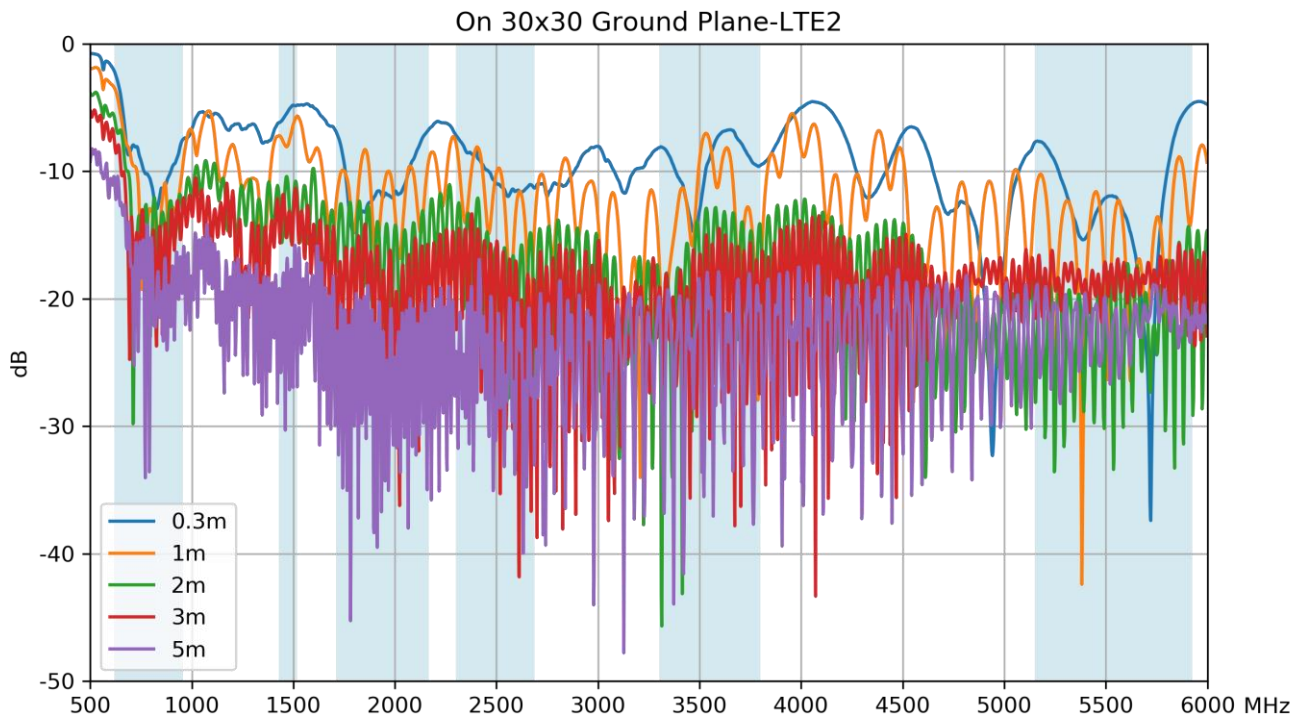

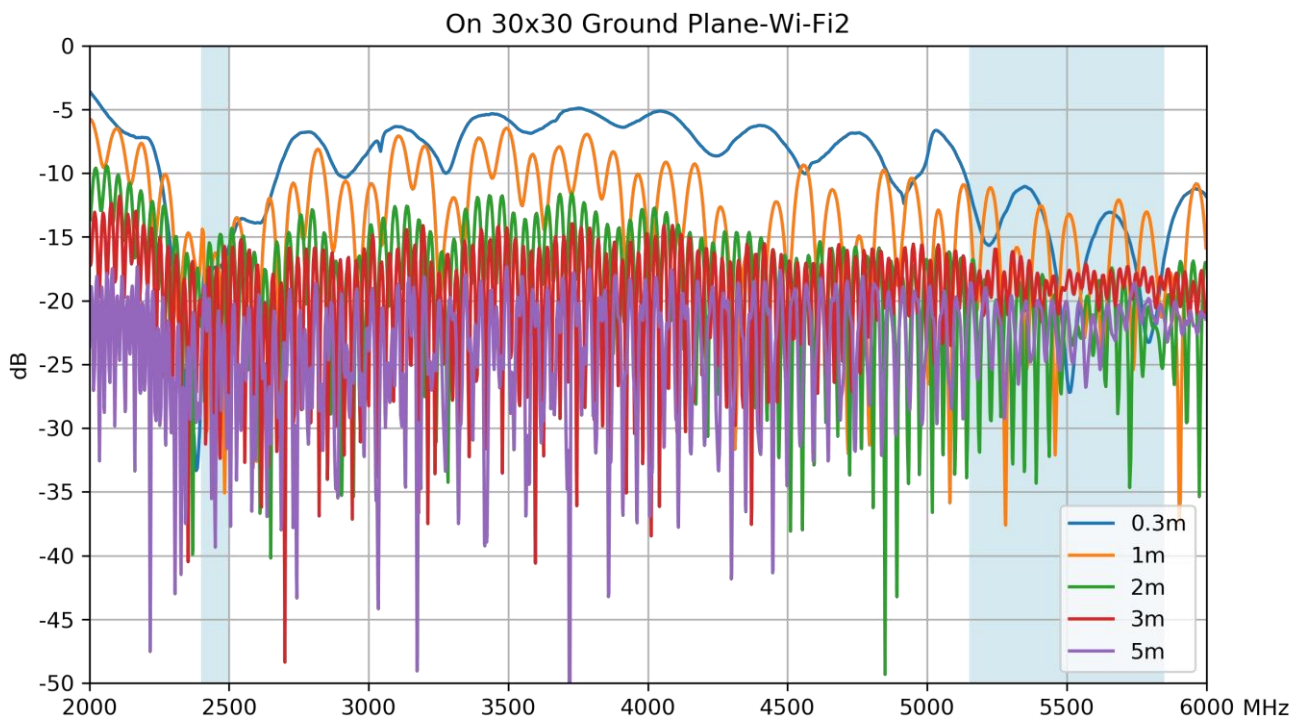

## 9.2 Efficiency

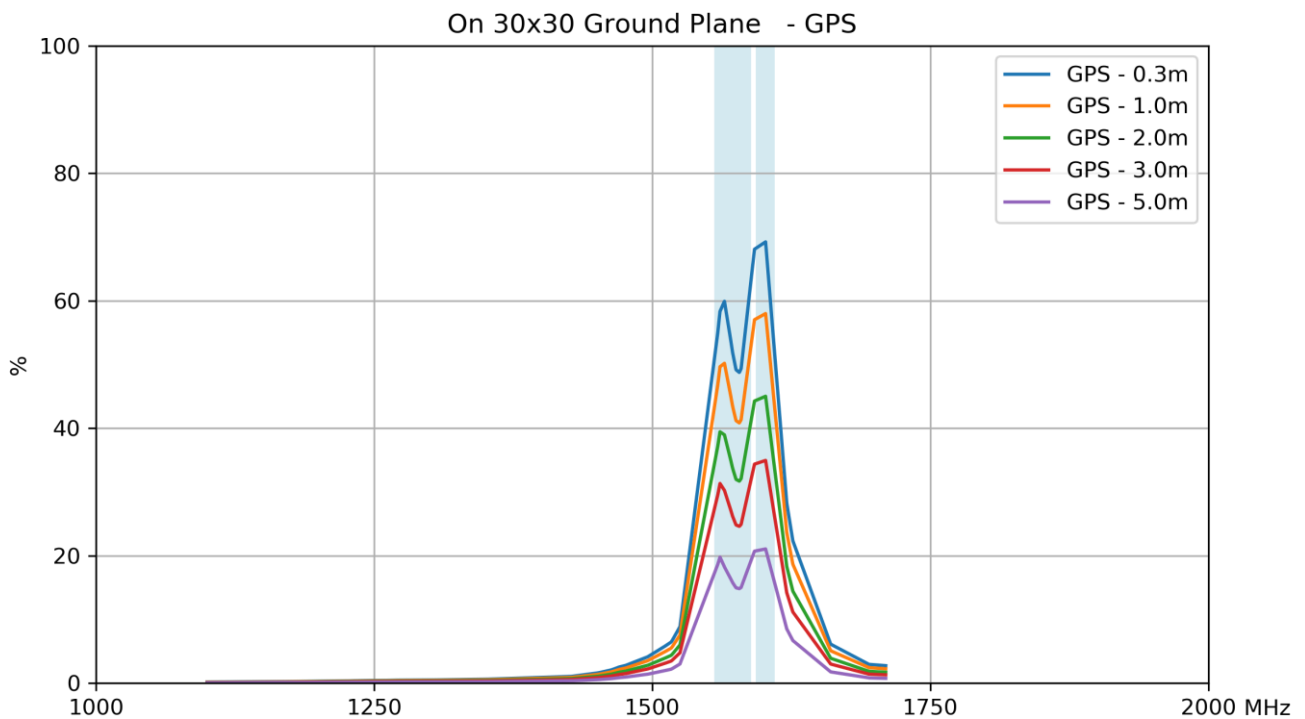

On 30x30 Ground Plane - LTE1

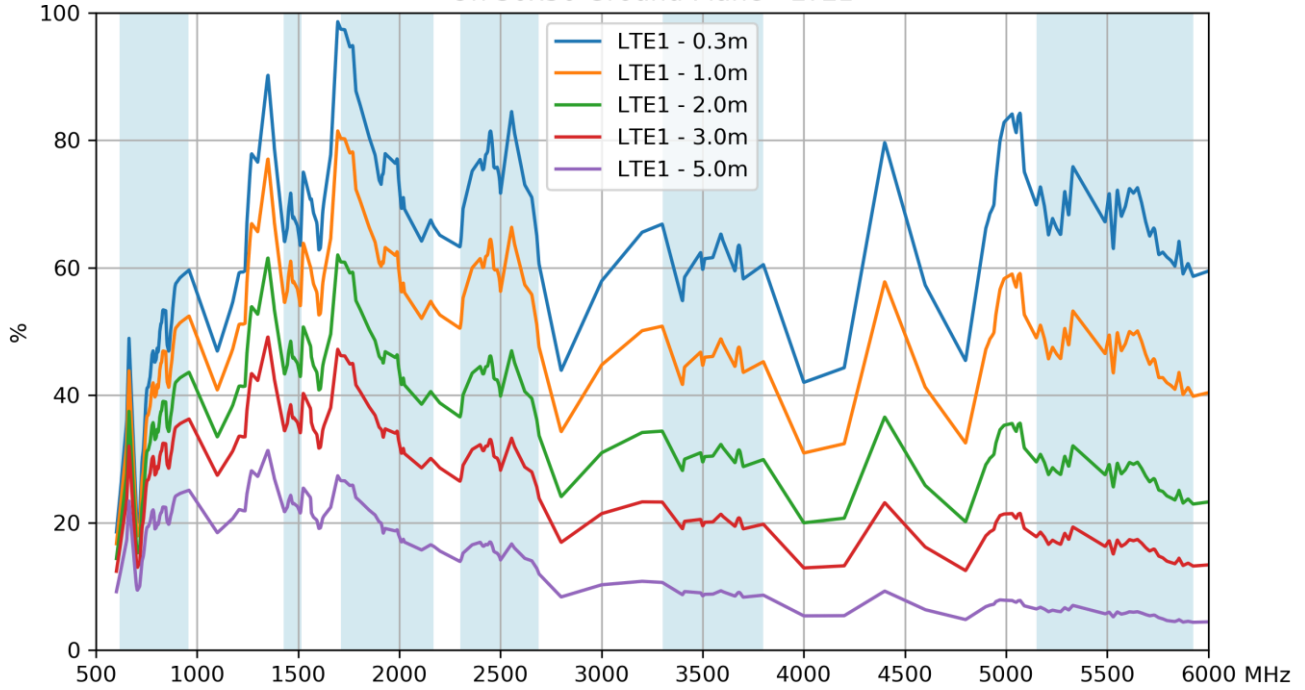

On 30x30 Ground Plane - LTE2

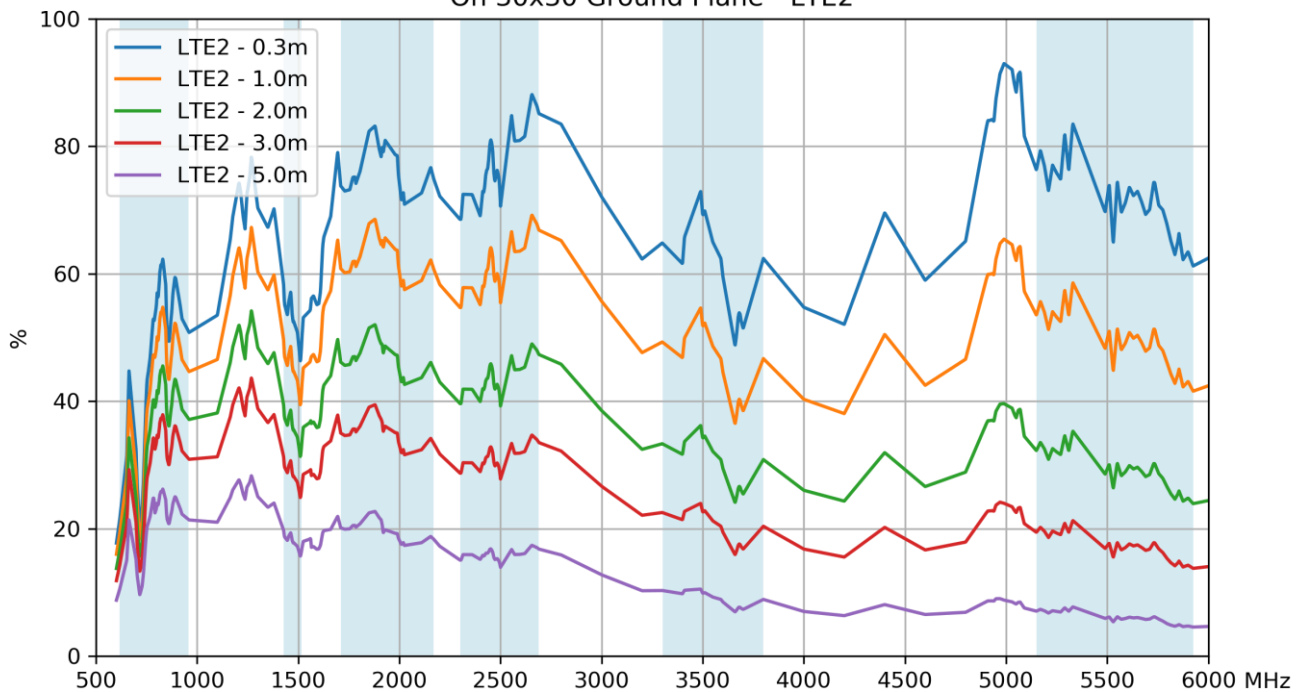

On 30x30 Ground Plane - Wi-Fi1

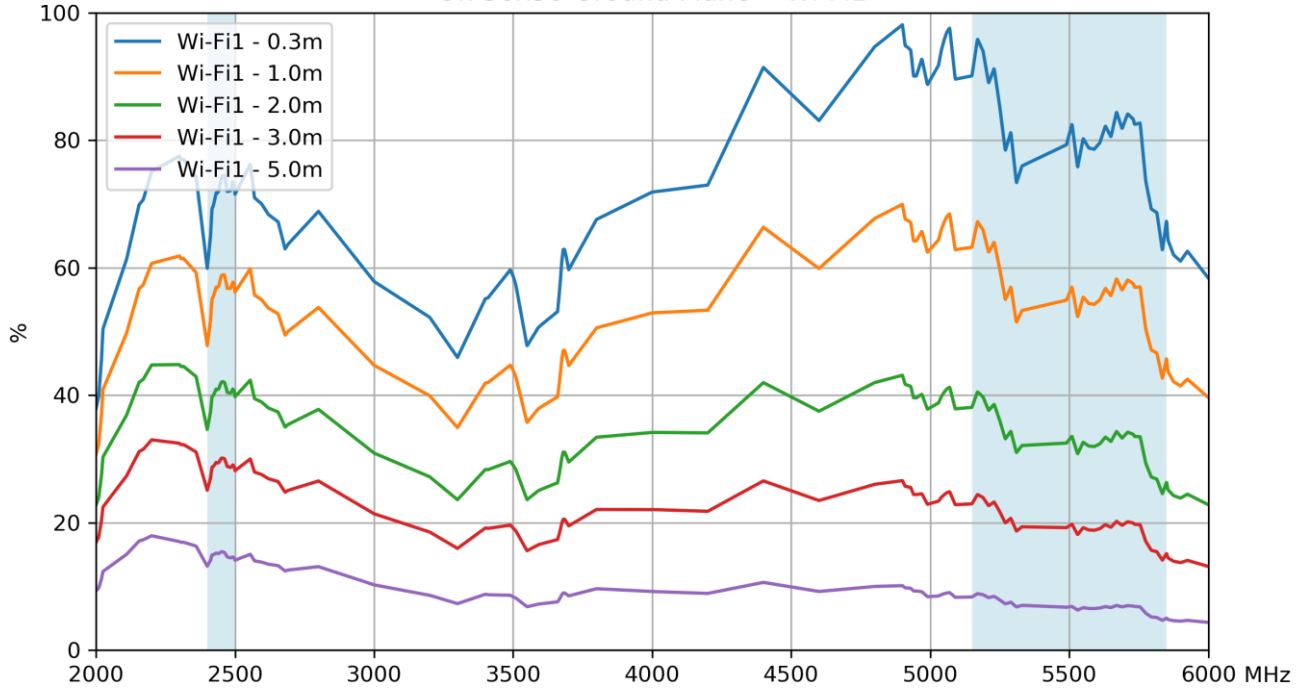

On 30x30 Ground Plane - Wi-Fi2

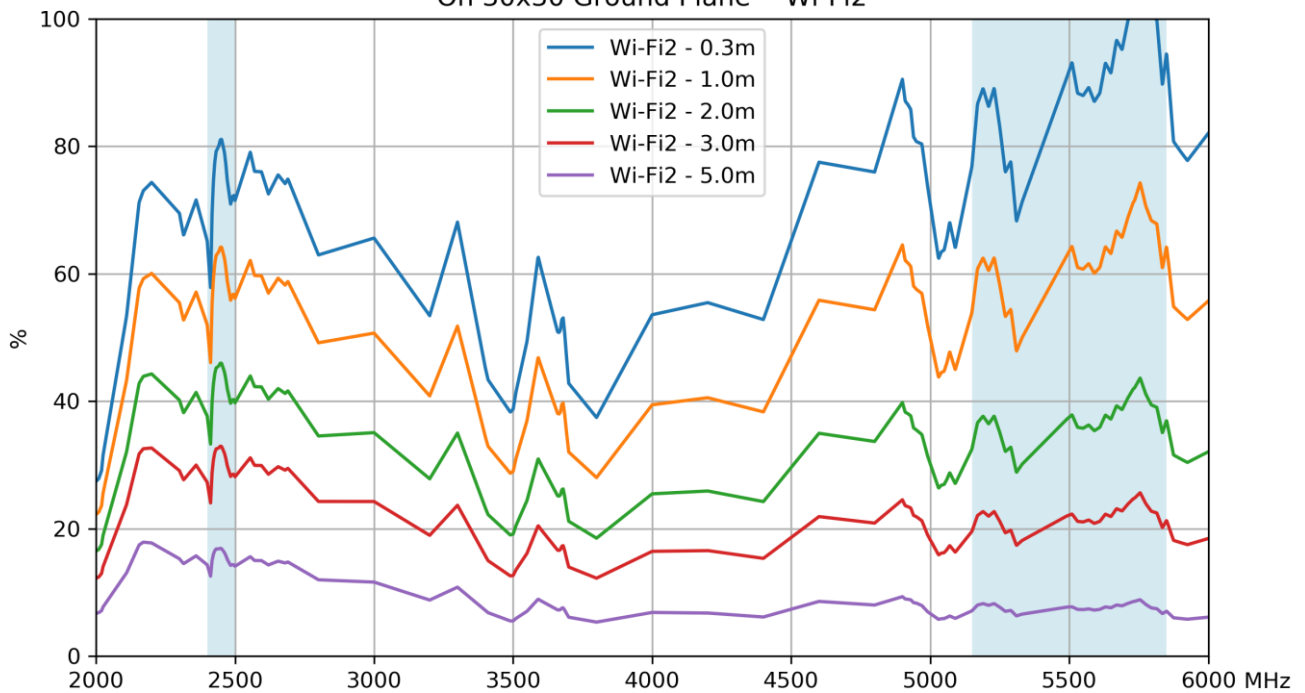

### 9.3 Average Gain

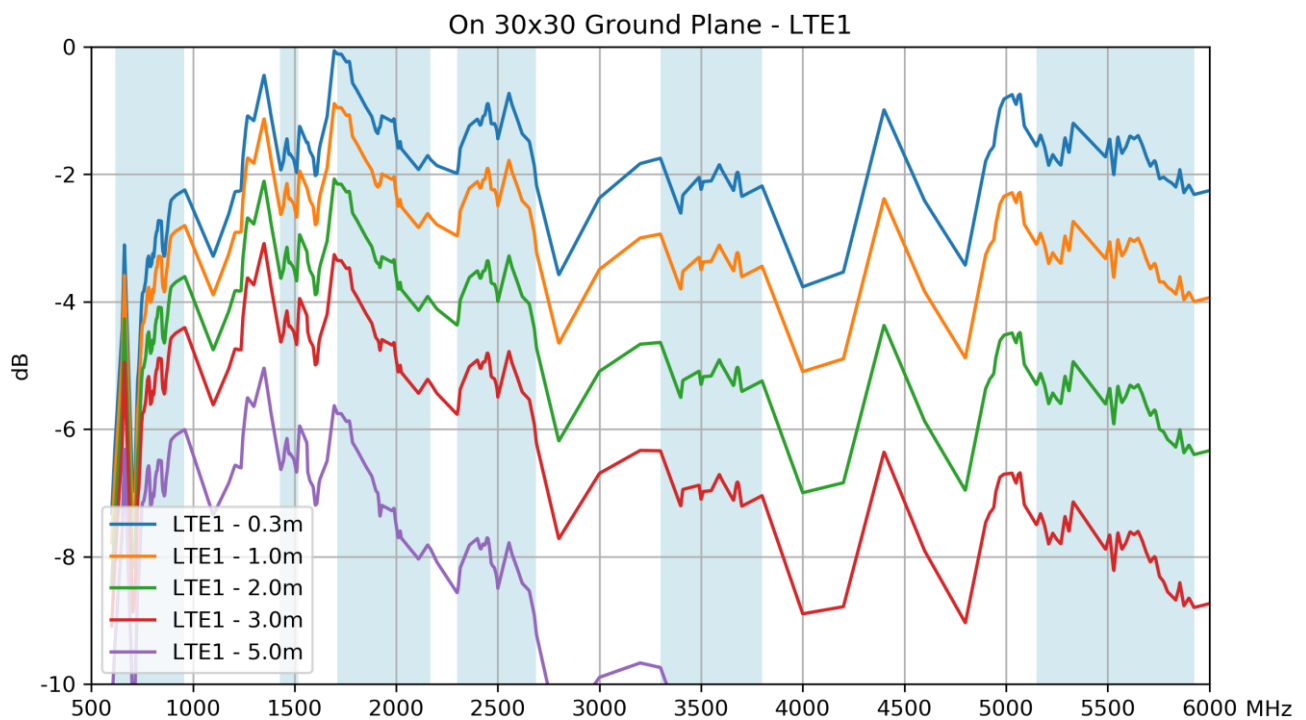
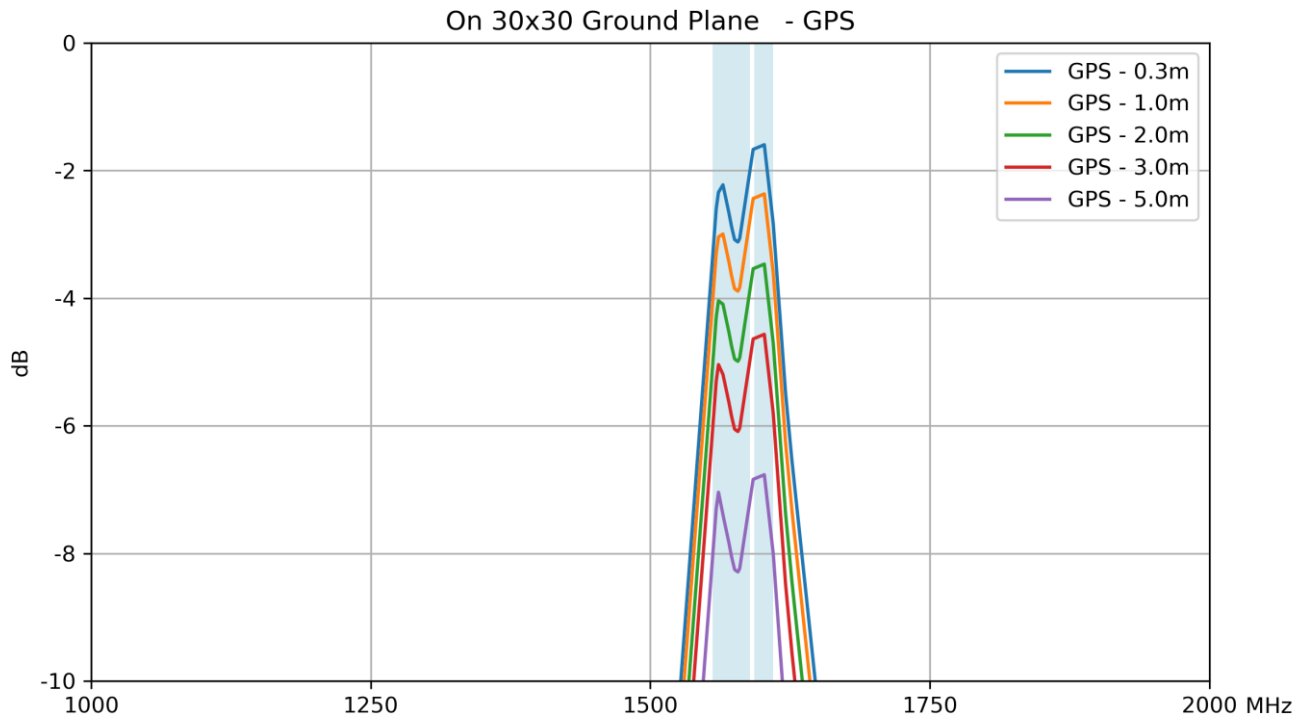

On 30x30 Ground Plane - LTE2

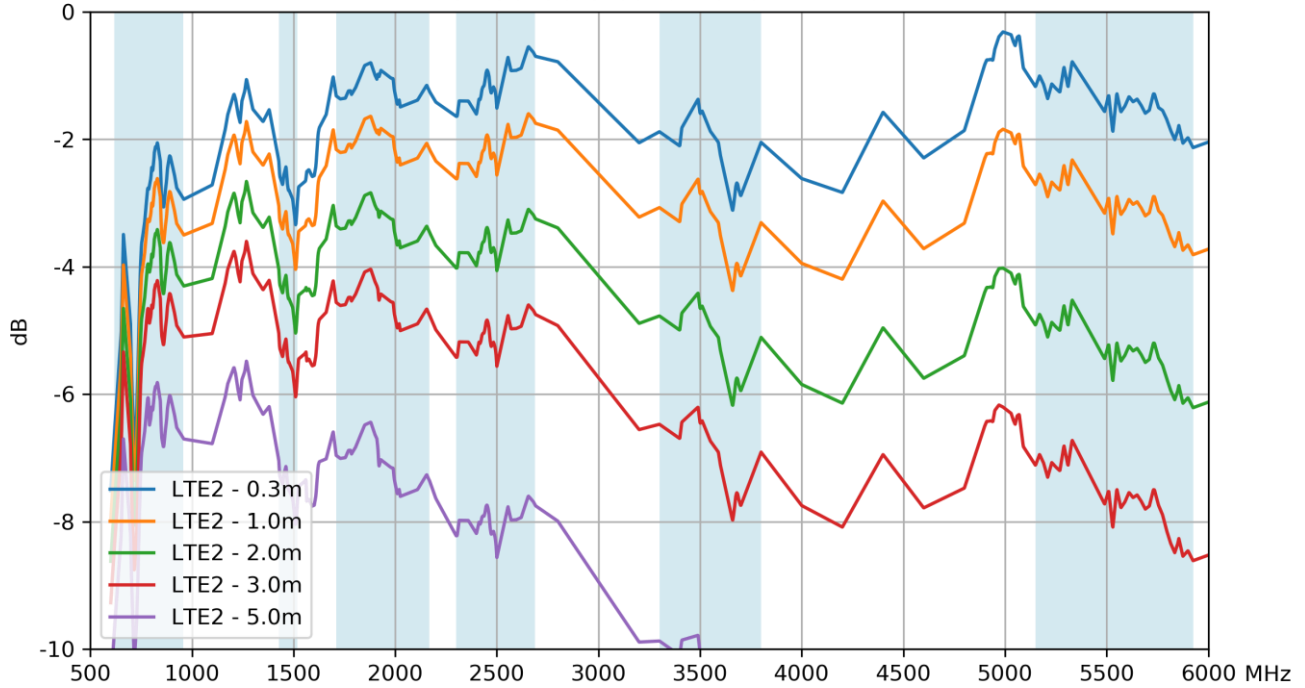

On 30x30 Ground Plane - Wi-Fi1

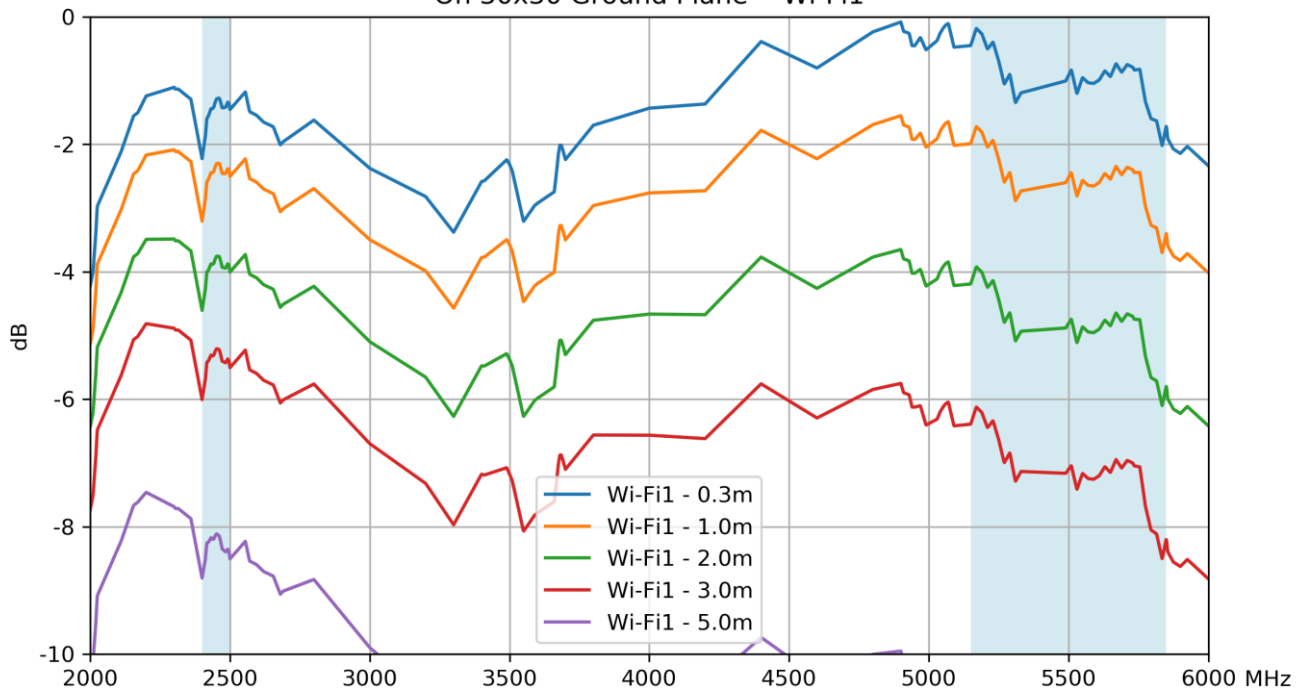

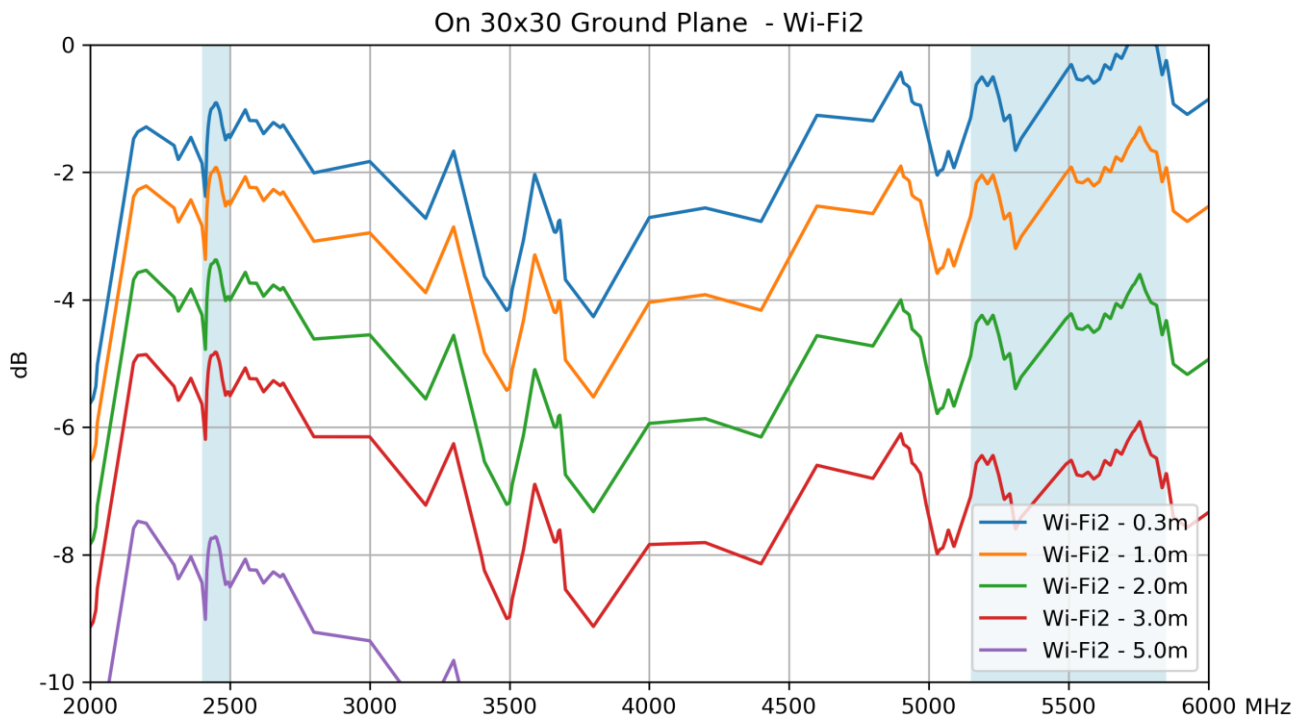

## 9.4 Peak Gain

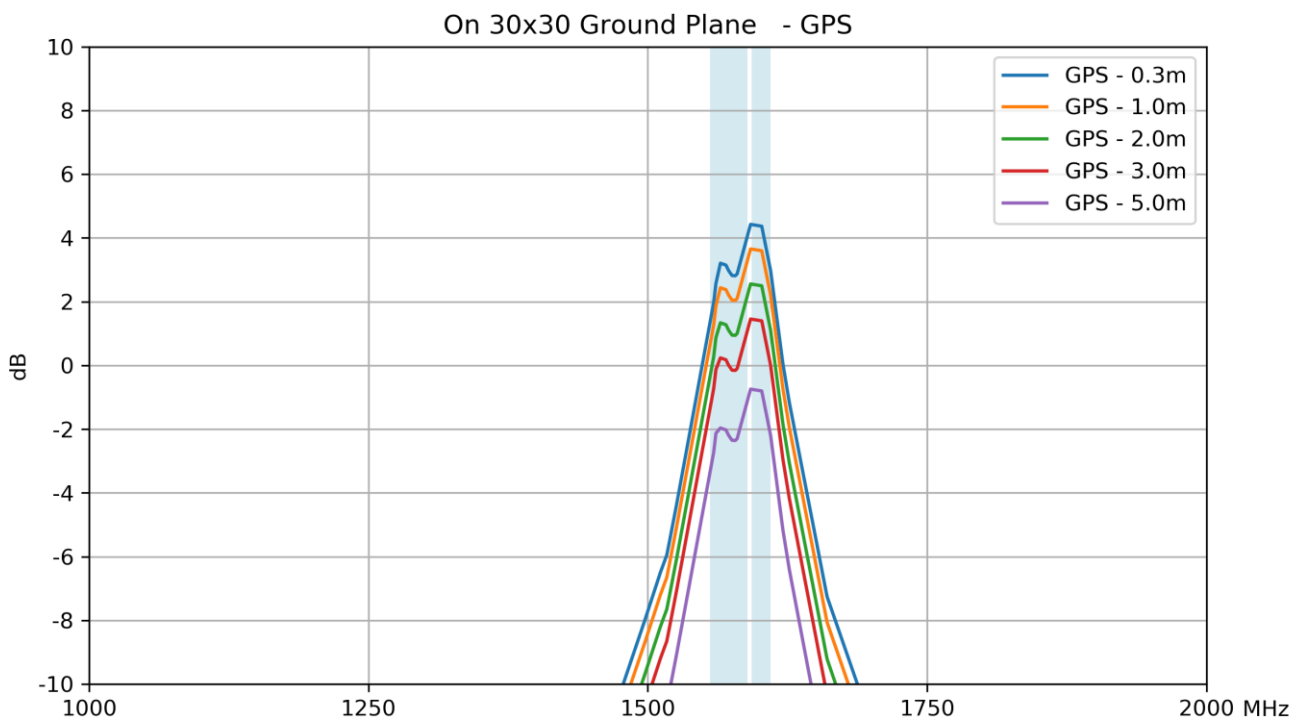

On 30x30 Ground Plane - LTE1

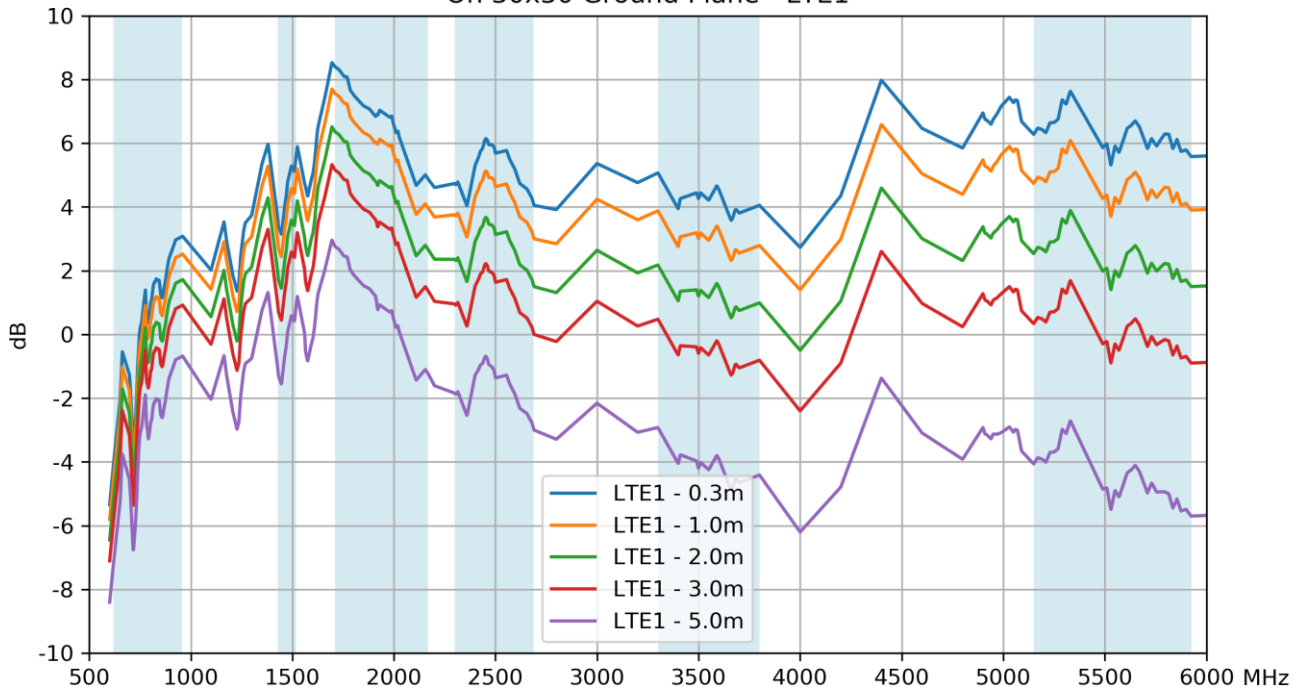

On 30x30 Ground Plane - LTE2

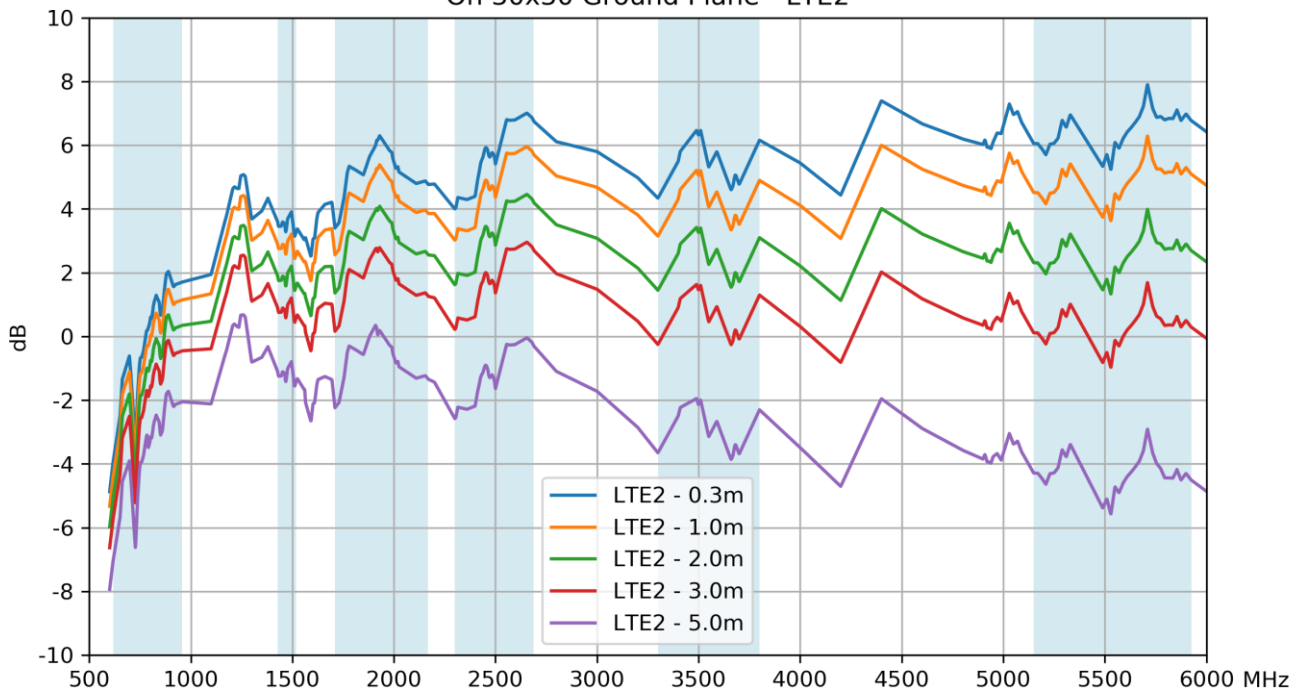

On 30x30 Ground Plane - Wi-Fi1

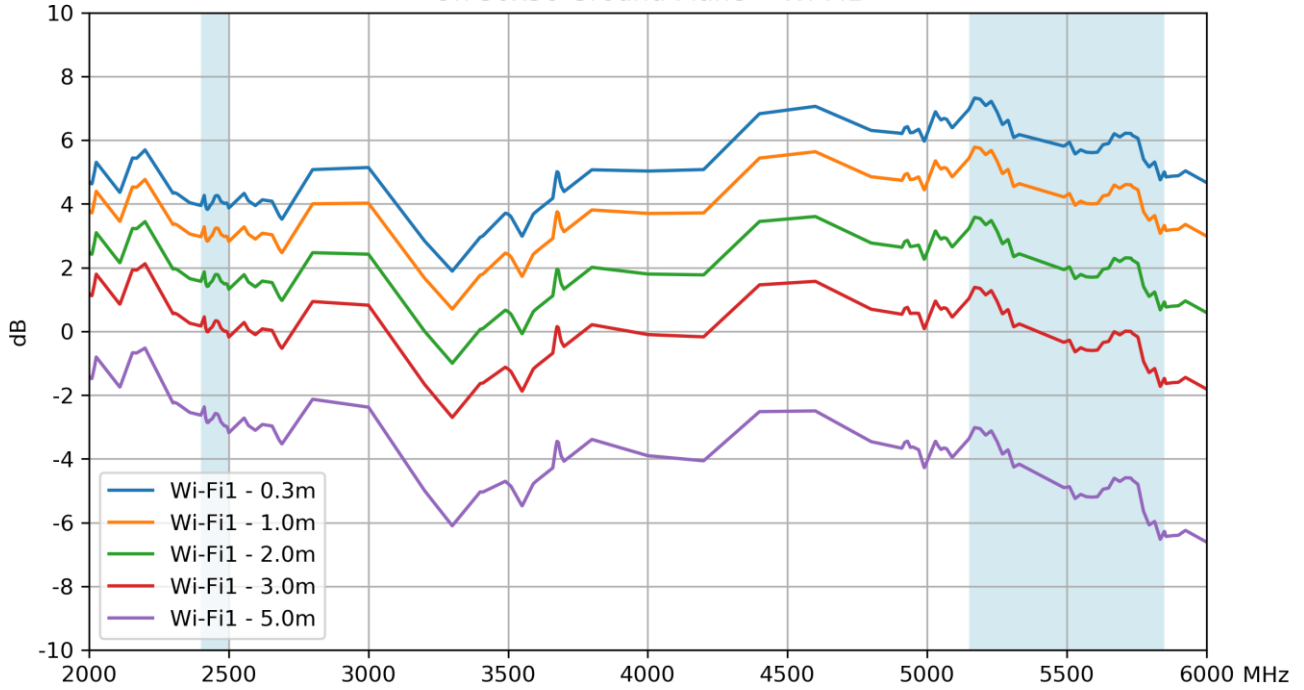

On 30x30 Ground Plane - Wi-Fi2

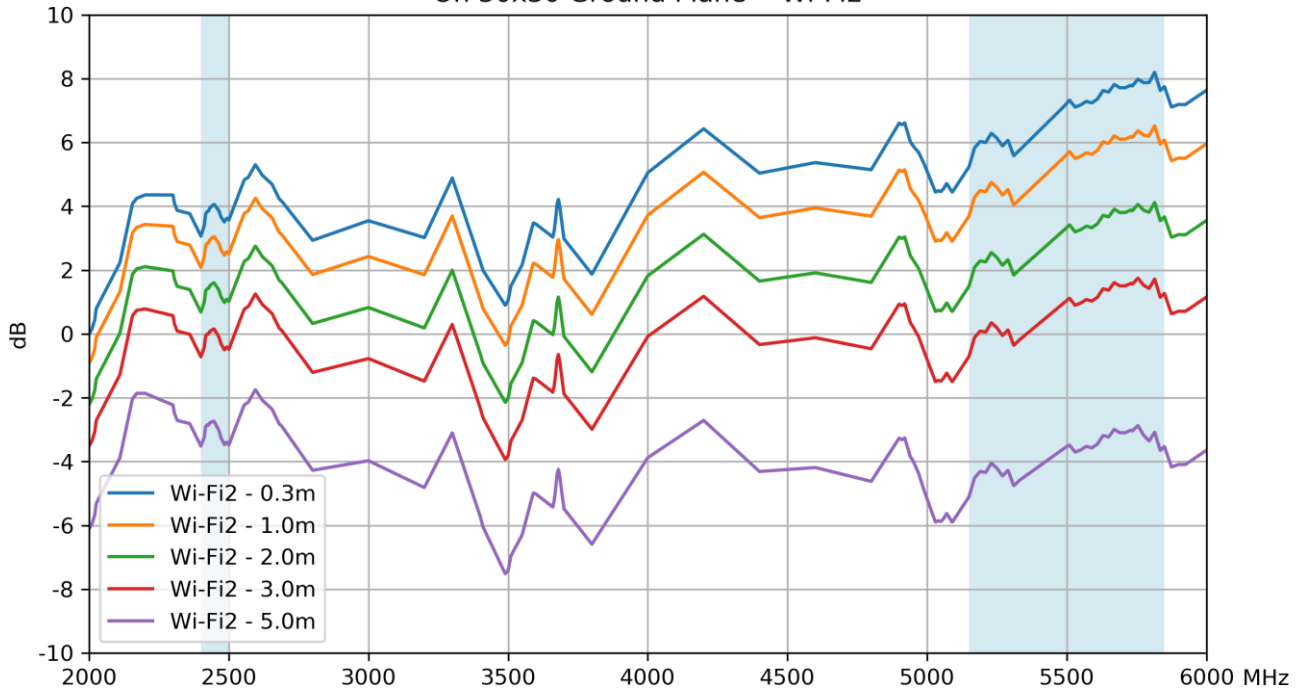

## 9.5 5G/4G performance over different cable lengths

5G/4G MIMO Electrical											
Frequency (MHz)	5G NR B71	LTE 700	GSM 850/900	5G NR B74~76	Band 3,9	Band 2,25,35,39	Bands 1,23,66	LTE 2600	5G NR B77~79	LTE 5200	
	617~698	698~824	824~960	1427~1518	1710~1880	1850~1990	1920~2170	2300~2690	3300~3500	5150~5925	
Efficiency (%)											
MIMO 1	0.3m	32.9	39.2	52.7	67.4	89.6	76.2	71.6	75.1	61.5	66.7
	1.0m	29.5	34.8	46.3	57.4	73.8	62.3	58.1	59.4	46.1	46.1
	2.0m	25.2	29.4	38.5	45.6	56.0	46.7	43.1	42.5	30.6	27.2
	3.0m	21.5	24.8	32.1	36.2	42.5	35.0	31.9	30.4	20.3	16.1
	5.0m	15.8	17.7	22.2	22.9	24.4	19.7	17.5	15.6	8.9	5.6
MIMO 2	0.3m	32.5	43.9	55.1	53.4	76.2	80.0	75.6	77.1	59.3	71.5
	1.0m	29.1	39.0	48.4	45.5	62.8	65.4	61.3	60.9	44.5	49.4
	2.0m	24.9	32.9	40.3	36.1	47.6	49.1	45.5	43.6	29.5	29.2
	3.0m	21.3	27.7	33.5	28.7	36.1	36.8	33.7	31.2	19.6	17.2
	5.0m	15.5	19.7	23.2	18.1	20.8	20.7	18.5	15.9	8.6	6.0
Average Gain (dB)											
MIMO 1	0.3m	-4.8	-4.1	-2.8	-1.7	-0.5	-1.2	-1.5	-1.3	-2.1	-1.8
	1.0m	-5.3	-4.6	-3.3	-2.4	-1.3	-2.1	-2.4	-2.3	-3.4	-3.4
	2.0m	-6.0	-5.3	-4.1	-3.4	-2.5	-3.3	-3.7	-3.7	-5.1	-5.7
	3.0m	-6.7	-6.1	-4.9	-4.4	-3.7	-4.6	-5.0	-5.2	-6.9	-7.9
	5.0m	-8.0	-7.5	-6.5	-6.4	-6.1	-7.1	-7.6	-8.1	-10.5	-12.5
MIMO 2	0.3m	-4.9	-3.6	-2.6	-2.7	-1.2	-1.0	-1.2	-1.1	-2.3	-1.5
	1.0m	-5.4	-4.1	-3.2	-3.4	-2.0	-1.8	-2.1	-2.2	-3.5	-3.1
	2.0m	-6.0	-4.8	-4.0	-4.4	-3.2	-3.1	-3.4	-3.6	-5.3	-5.4
	3.0m	-6.7	-5.6	-4.8	-5.4	-4.4	-4.3	-4.7	-5.1	-7.1	-7.6
	5.0m	-8.1	-7.1	-6.4	-7.4	-6.8	-6.8	-7.3	-8.0	-10.6	-12.2
Peak Gain (dBi)											
MIMO 1	0.3m	-1.8	0.1	1.9	4.3	7.8	6.9	6.2	5.5	4.1	6.3
	1.0m	-2.3	-0.4	1.3	3.6	7.0	6.1	5.3	4.5	2.9	4.7
	2.0m	-3.0	-1.2	0.5	2.6	5.8	4.8	4.0	3.0	1.1	2.4
	3.0m	-3.7	-1.9	-0.3	1.6	4.6	3.6	2.7	1.6	-0.7	0.1
	5.0m	-5.0	-3.4	-1.9	-0.4	2.2	1.1	0.1	-1.4	-4.2	-4.5
MIMO 2	0.3m	-1.9	-0.4	1.4	3.5	4.9	5.9	5.5	5.7	5.4	6.6
	1.0m	-2.4	-0.9	0.8	2.8	4.0	5.0	4.6	4.7	4.2	5.0
	2.0m	-3.1	-1.6	0.0	1.8	2.8	3.8	3.3	3.3	2.4	2.7
	3.0m	-3.8	-2.3	-0.8	0.8	1.6	2.5	2.0	1.8	0.6	0.4
	5.0m	-5.1	-3.8	-2.4	-1.2	-0.8	0.0	-0.6	-1.1	-3.0	-4.2

## 9.6 Wi-Fi performance over different cable lengths

Wi-Fi MIMO			
Frequency (MHz)	Cable Length	2400~2500	5150~5850
<b>Efficiency (%)</b>			
MIMO 1	0.3m	71.4	80.4
	1.0m	56.5	55.7
	2.0m	40.4	33.0
	3.0m	29.0	19.5
	5.0m	14.8	6.9
MIMO 2	0.3m	74.9	90.2
	1.0m	59.3	62.4
	2.0m	42.5	36.9
	3.0m	30.4	21.8
	5.0m	15.6	7.6
<b>Average Gain (dB)</b>			
MIMO 1	0.3m	-1.5	-1.0
	1.0m	-2.5	-2.5
	2.0m	-3.9	-4.8
	3.0m	-5.4	-7.1
	5.0m	-8.3	-11.6
MIMO 2	0.3m	-1.3	-0.5
	1.0m	-2.3	-2.1
	2.0m	-3.7	-4.3
	3.0m	-5.2	-6.6
	5.0m	-8.1	-11.2
<b>Peak Gain (dBi)</b>			
MIMO 1	0.3m	4.1	6.1
	1.0m	3.1	4.5
	2.0m	1.6	2.3
	3.0m	0.1	0.0
	5.0m	-2.8	-4.5
MIMO 2	0.3m	3.8	7.1
	1.0m	2.8	5.5
	2.0m	1.3	3.2
	3.0m	-0.1	0.9
	5.0m	-3.0	-3.7

Changelog for the datasheet

**SPE-24-8-118 – MA1290.A.LBICGT.Y.001**

<b>Revision: B (Current Version)</b>	
Date:	2024-06-06
Notes:	Updated cable length from 5m to 3m.
Author:	Gary West

**Previous Revisions**

<b>Revision: A (Original First Release)</b>	
Date:	2023-05-08
Notes:	
Author:	Jack Conroy



**TAOGLAS**®

[www.taoglas.com](http://www.taoglas.com)

