



TAOGLAS®



Datasheet

Guardian

Part No:
MA997.A.003

Description

7in1 Guardian - 1*GNSS, 4*5G/4G MIMO and 2*Wi-Fi MIMO

Features:

Low-profile Housing with Wall Mount
1* GNSS (L1/L5)
4* 5G/4G MIMO 600 – 6000 MHz
2* WI-FI MIMO 2.4GHz/5.8/7.125 GHz
Worldwide 4G Bands including 3G and 2G
IP67 Waterproof Enclosure
Dims: 146.05mm * 136.05mm * 20mm
Cables: 2m Low Loss TGC-302 and RG174
Connectors: GNSS and Cellular SMA(M) / Wi-Fi RP-SMA(M)
Custom Cables and Connectors Available
RoHS & Reach Compliant

1.	Introduction	3
2.	Specification	5
3.	Mechanical Drawing	9
4.	Packaging	10
5.	Antenna Characteristics	12
6.	LNA Characteristics	21
7.	Radiation Patterns	24
<hr/>		
	Changelog	89

Taoglas makes no warranties based on the accuracy or completeness of the contents of this document and reserves the right to make changes to specifications and product descriptions at any time without notice. Taoglas reserves all rights to this document and the information contained herein. Reproduction, use or disclosure to third parties without express permission is strictly prohibited.



1. Introduction



The Taoglas MA997 Guardian Series has been designed to be the smallest, high-performance combination panel antenna in the world. The heavy-duty, IP67 rated, external enclosure combines all 7 antenna elements in a low profile, compact form. The Guardian combines 1x GNSS, 4x 5G/4G Cellular antennas and 2x Wi-Fi 6 antennas making it compatible with the next generation of modules and routers.

The MA997 has been designed as a low-profile solution for IoT and Automotive applications where space is at a premium allowing it to be installed in the headliners of vehicles or on the back window of a vehicle. The Guardian series is an ideal external combination antenna solution that can be used where drilling a hole through the roof of a vehicle or a metal panel for an external antenna is not feasible or desired.

Typical applications include:

- Passenger Bus and Rail Applications
- Automotive and Heavy Equipment
- Vehicle Tracking and Telematics
- First Responder and Emergency Services
- HPUE applications such as Public Safety Communications and Critical Infrastructure and Utilities

The Guardian can be adhesive, or wall mounted as standard. The adhesive pad and wall bracket are included in the product packaging. Pole and desk mount option are also available as separate kits.

Taoglas also provides services to ensure optimum overall performance for your entire system by working closely with the customer to design in the best antenna and potential additional components for your system. 5G/4G applications demand high-speed data uplink and downlink. High efficiency and high gain MIMO antennas are necessary to achieve the required signal to noise ratio and throughput required to solve these challenges.

Taoglas also takes care to ensure high isolation between the MIMO antennas to prevent self-interference. Low loss cables are used to keep efficiency high over longer cable lengths. In contrast, smaller MIMO antennas with poor quality thin cables will have reduced efficiency and isolation, which would lead to a large drop in system throughput, increased incidences of signal drops, and may indeed not make a system connection at all.

Cable type and length, and connectors are fully customizable, and the Guardian can also be customized for other configurations. Contact your regional Taoglas customer support team for more information.

2. Specification

GNSS Frequency Bands					
GPS	L1 1575.42 MHz	L2 1227.6 MHz	L5 1176.45 MHz		
	■	□	■		
GLONASS	G1 1602 MHz	G2 1248 MHz	G3 1207 MHz		
	■	□	□		
Galileo	E1 1575.24 MHz	E5a 1176.45 MHz	E5b 1201.5 MHz	E6 1278.75 MHz	
	■	■	□	□	
BeiDou	B1C 1575.42 MHz	B1I 1561 MHz	B2a 1176.45 MHz	B2b 1207.14 MHz	B3 1268.52 MHz
	■	■	■	□	□
L-Band	L-Band 1542 MHz				
	□				
QZSS (Regional)	L1 1575.42 MHz	L2C 1227.6 MHz	L5 1176.45 MHz	L6 1278.75e6	
	■	□	■	□	
IRNSS (Regional)	L5 1176.45 MHz				
	■				
SBAS	L1/E1/B1 1575.42 MHz	L5/B2a/E5a 1176.45 MHz	G1 1602 MHz	G2 1248 MHz	G3 1207 MHz
	■	■	■	□	□

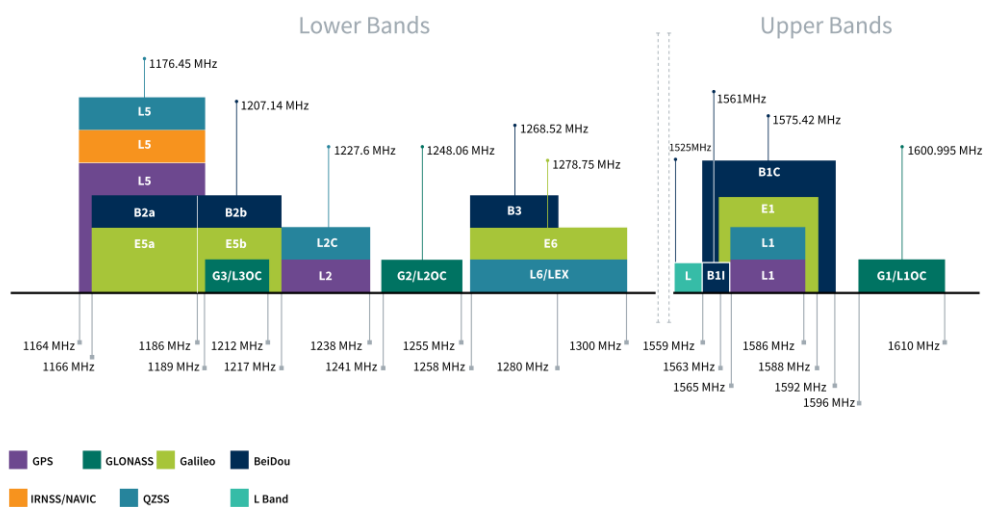

GNSS Bands and Constellations

GNSS Electrical				
Frequency (MHz)	1176.45	1561	1575.42	1603
Passive Antenna Efficiency (%)	58.5	68.5	60.7	62.5
Average Gain (dB)	-2.33	-1.64	-2.17	-2.04
Peak Gain (dBi)	2.31	2.94	2.87	3.08
PCO (cm)	N/A	N/A	N/A	N/A
PCV (cm)	N/A	N/A	N/A	N/A
Group Delay Mean (ns)	46.51	29.7	31.48	19.62
Group Delay Variation (ns)	72	52	88	92
Impedance	50 Ω			
Polarization	Linear			
Radiation Pattern	Omni			
Max. input power	10W			
*Tested on 70x70 mm ground plane				

LNA and Filter Electrical Properties				
Frequency (MHz)	1176.45	1561	1575.42	1603
Gain(dB)	30.3	28.2	28.3	28.3
Nosie Figure(dB)	2.6	2.8	2.8	2.4
Return Loss (dB)	< -8			
Input Voltage (V)	+ 1.8 to 5.5			
Current consumption (mA)	10 \pm 3			
Outer Band Attenuation (dB)	> 70dB @ 600-960MHz ; > 65dB @ 1710-3000MHz			

LTE Electrical									
Band	Frequency (MHz)	Measurement	Efficiency (%)	Average Gain (dB)	Peak Gain (dBi)	Impedance	Polarization	Radiation Pattern	Max. input power
5G NR/4G Band 71	617-698	LTE1	41.0	-3.87	1.85	50 Ω	Linear	Omni	2W
		LTE2	43.0	-3.66	1.78				
		LTE3	47.5	-3.24	4.23				
		LTE4	39.5	-4.03	2.26				
4G/3G Band 12,13,14,17,28,29	698-824	LTE1	56.2	-2.50	3.06				
		LTE2	52.7	-2.78	3.76				
		LTE3	45.8	-3.39	2.94				
		LTE4	53.0	-2.76	3.81				
4G/3G/NB-IoT/Cat M Band 5,8,18,19,20,26,27	824-960	LTE1	62.6	-2.04	3.53				
		LTE2	64.5	-1.90	3.96				
		LTE3	53.2	-2.74	3.46				
		LTE4	59.0	-2.29	5.15				
5G NR/4G Band 21,32,74,75,76	1427-1518	LTE1	71.0	-1.49	3.95				
		LTE2	58.3	-2.34	2.63				
		LTE3	59.8	-2.23	2.49				
		LTE4	67.0	-1.74	3.66				
4G/3G Band 1,2,3,4,9,23,25,35,39,66	1710-2200	LTE1	47.4	-3.24	2.61				
		LTE2	46.0	-3.37	2.49				
		LTE3	46.7	-3.30	3.18				
		LTE4	49.5	-3.05	3.32				
4G/3G Band 7,30,38,40,41	2300-2690	LTE1	52.6	-2.79	4.33				
		LTE2	50.4	-2.97	3.65				
		LTE3	51.7	-2.87	3.48				
		LTE4	52.9	-2.76	4.18				
5G NR/4G Band 22,42,48,77,78,79	3300-5000	LTE1	66.4	-1.78	7.26				
		LTE2	63.9	-1.95	6.95				
		LTE3	64.3	-1.92	6.21				
		LTE4	69.3	-1.59	7.42				
LTE5200/Wi-Fi5800	5150-5925	LTE1	54.5	-2.63	5.96				
		LTE2	58.9	-2.30	5.15				
		LTE3	56.1	-2.51	5.21				
		LTE4	52.1	-2.83	5.38				

Wi-Fi Electrical									
Band	Frequency (MHz)	Measurement	Efficiency (%)	Average Gain (dB)	Peak Gain (dBi)	Impedance	Polarization	Radiation Pattern	Max. input power
WiFi - 2GHz	2400-2500	Wi-Fi1	47.1	-3.27	2.45	50 Ω	Linear	Omni	2W
		Wi-Fi2	43.1	-3.66	2.74				
WiFi - 5GHz	5150-5850	Wi-Fi1	61.0	-2.14	5.00				
		Wi-Fi2	58.5	-2.33	4.70				
WiFi - 6GHz	5925-7125	Wi-Fi1	54.7	-2.62	5.15				
		Wi-Fi2	54.7	-2.62	4.44				

Mechanical	
Dimensions	146.06 x 136.05 x 20mm
Weight	800g
Material	ASA
Connector	GNSS – SMA(M) Wi-Fi – SMA(M) – RP LTE – SMA(M)
Cable	GNSS – RG-174 Wi-Fi – TGC-302 LTE – TGC-302

Environmental	
Temperature Range	-40°C to 85°C
Relative Humidity	Non-condensing 65°C 95% RH
RoHs & REACH Compliant	Yes

3. Mechanical Drawing

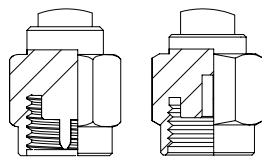
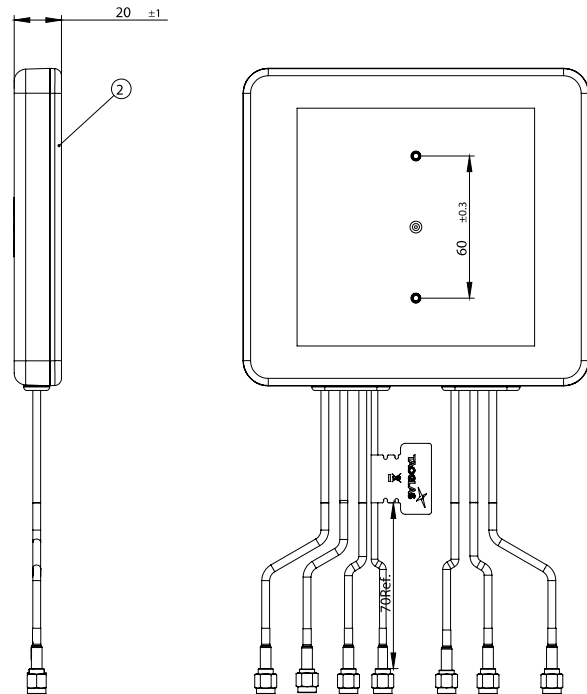
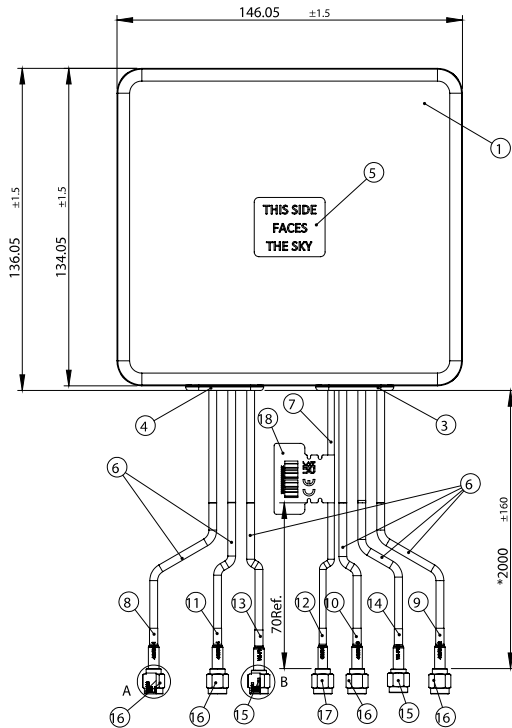

DETAIL A
SCALE 2 : 1

DETAIL B
SCALE 2 : 1

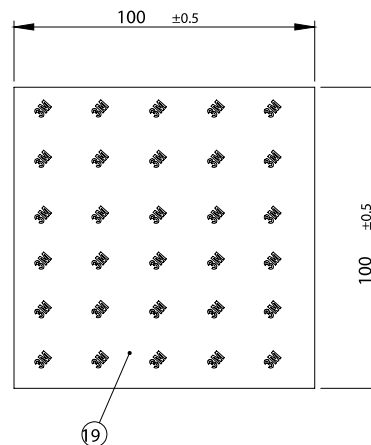
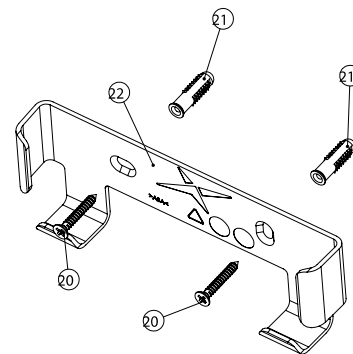

	Name	Material	Finish	Qty
1	Top Housing	ASA	Black	1
2	Bottom housing_Guardian_Black	ASA	Black	1
3	Grommet 1_Black	Silicone Rubber	Black	1
4	Grommet 2_Black	Silicone Rubber	Black	1
5	Clear Label White Font (30x25)	PET	Clear Label White Font	1
6	TGC-302 low loss coaxial cable	PVC	Black	6
7	RG174 Coaxial Cable	PVC	Black	1
8	Heat Shrink Tube(4G/5G-1)	PE	Red Tube/White Text	1
9	Heat Shrink Tube(4G/5G-2)	PE	Red Tube/White Text	1
10	Heat Shrink Tube(4G/5G-3)	PE	Red Tube/White Text	1
11	Heat Shrink Tube(4G/5G-4)	PE	Red Tube/White Text	1
12	Heat Shrink Tube(GNSS)	PE	Blue Tube/White Text	1
13	Heat Shrink Tube (WiFi-1)	PE	Yellow tube/ Black text	1
14	Heat Shrink Tube (WiFi-2)	PE	Yellow Tube/Black Text	1
15	SMA(M)ST_RP	Brass	AU PLATING	2
16	SMA(M)ST Plug for TGC-302	Brass	Au Plated	4
17	SMA(M)ST Plug_for RG-31B/RG-174	Brass	Au Plated	1
18	CE,WEEE and UKCA mark logo Label	PEPA	White	1
19	Double Adhesive Foam(100x100x3.54)	CR4305-3(M9448HK 3.5)	Black	1
20	Tapping Screw_M3.5*25 countersink flat	SUS304	N/A	2
21	Wall Mount Stud 6*24L	Nylon	White	2
22	Wall Mounting Bracket	ASA	Black	1

4. Packaging

1 PCS / Zipper bag



1 PCS / PE bag



Box: 260 x 235 x 105mm
 SPQ Label
 Barcode Label
 Weight: 820g



6 PCS / Carton
Carton: 475 x 272 x 325mm
Carton Label
Weight: 5.69Kg



5. Antenna Characteristics

5.1 Test Setup

AUT



Vector Network Analyzer

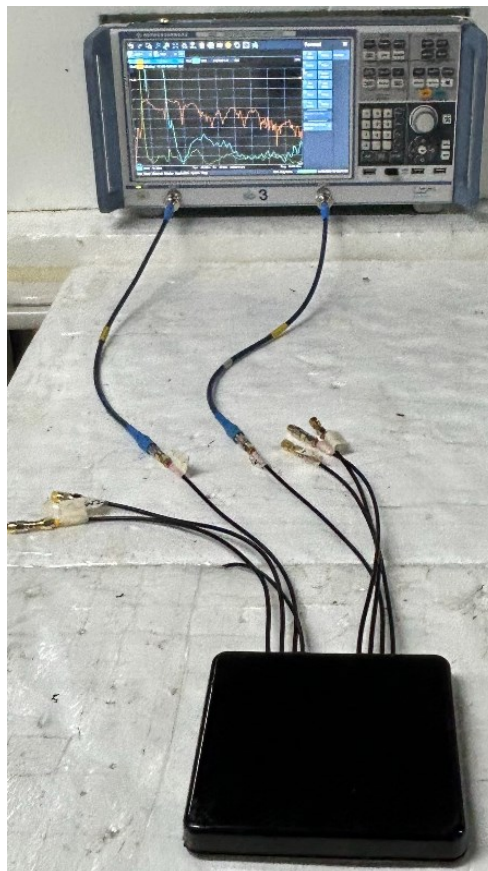

VNA Test Set-up

5.2 GNSS – Return Loss

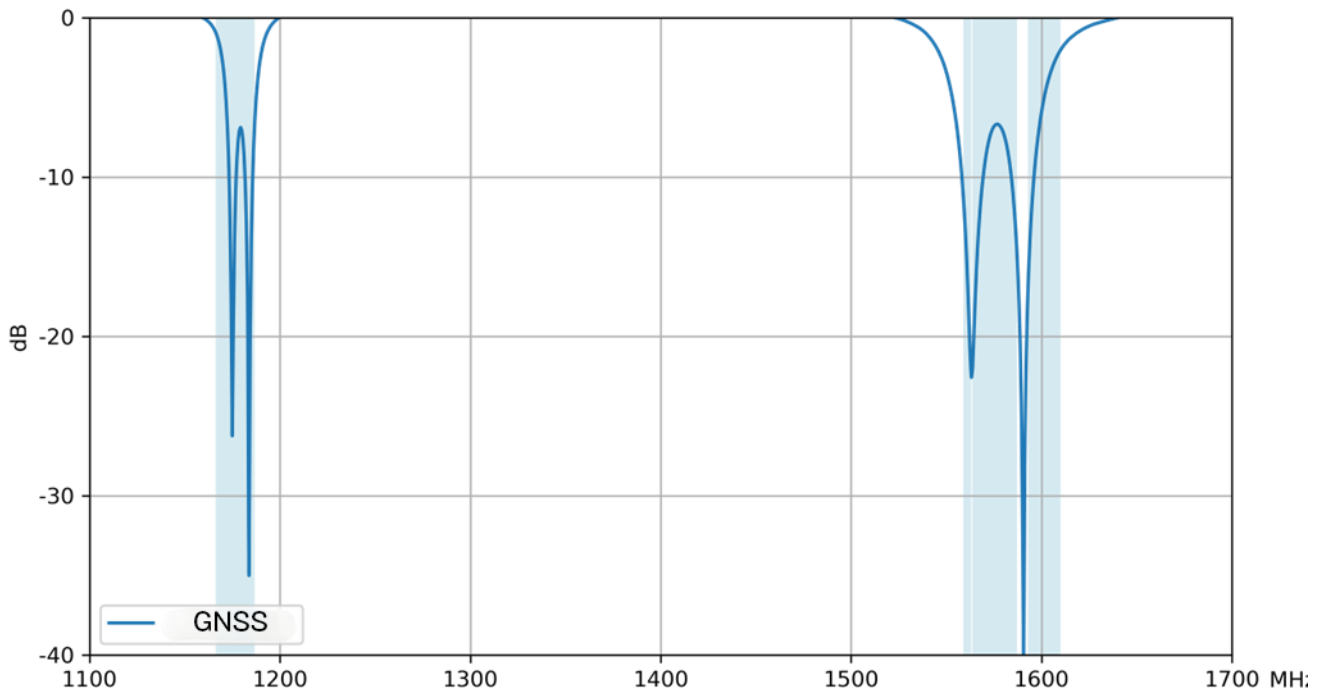

5.3 GNSS – Efficiency

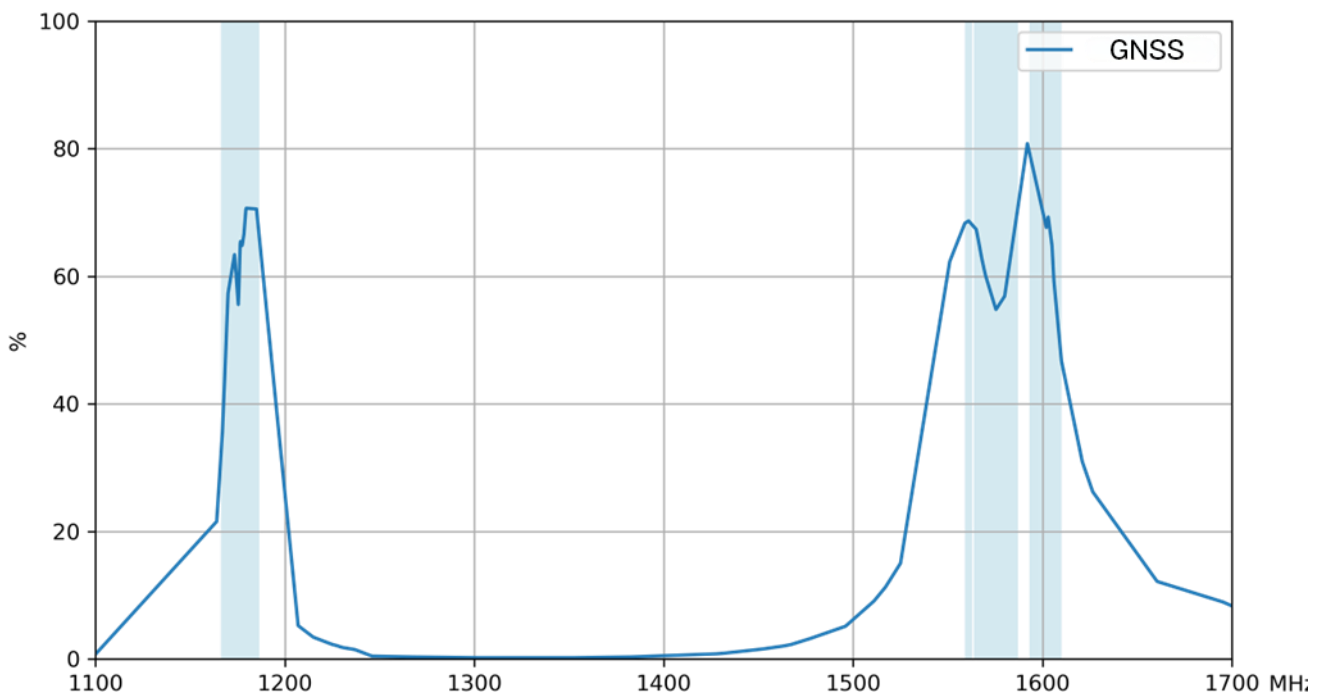

5.4 GNSS – Average Gain

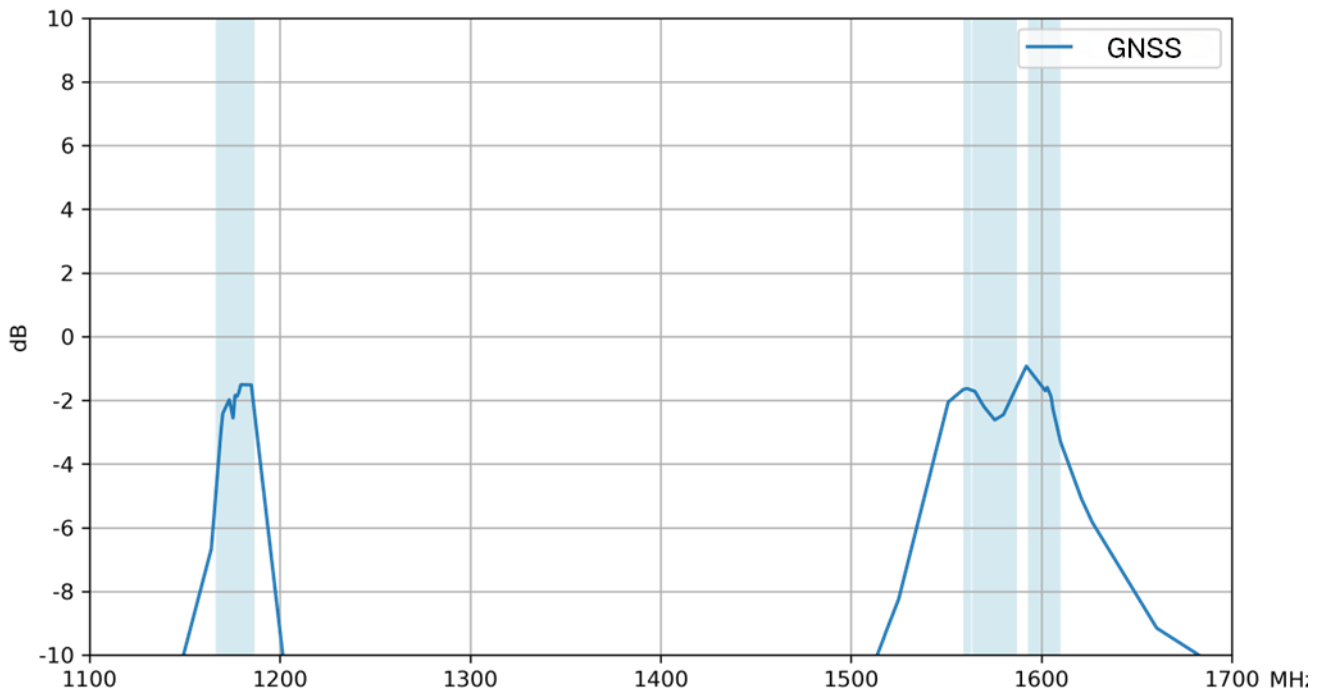

5.5 GNSS – Peak Gain

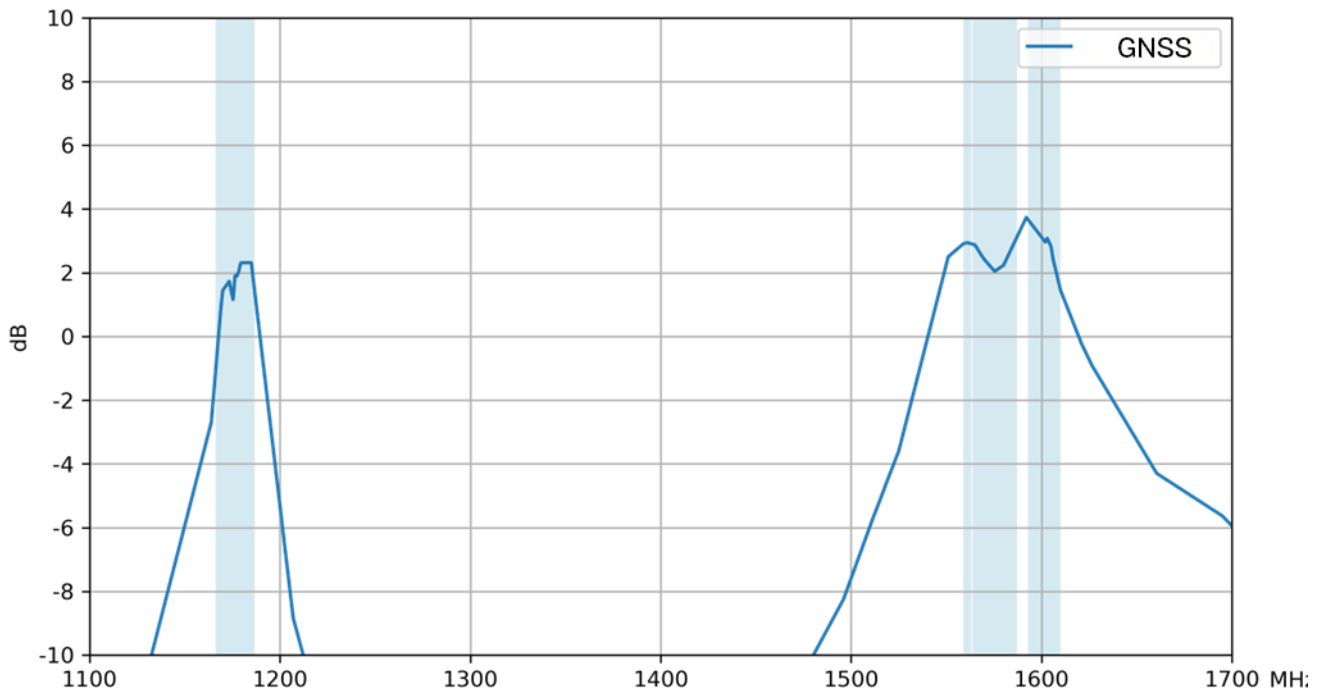

5.6 LTE - Return Loss

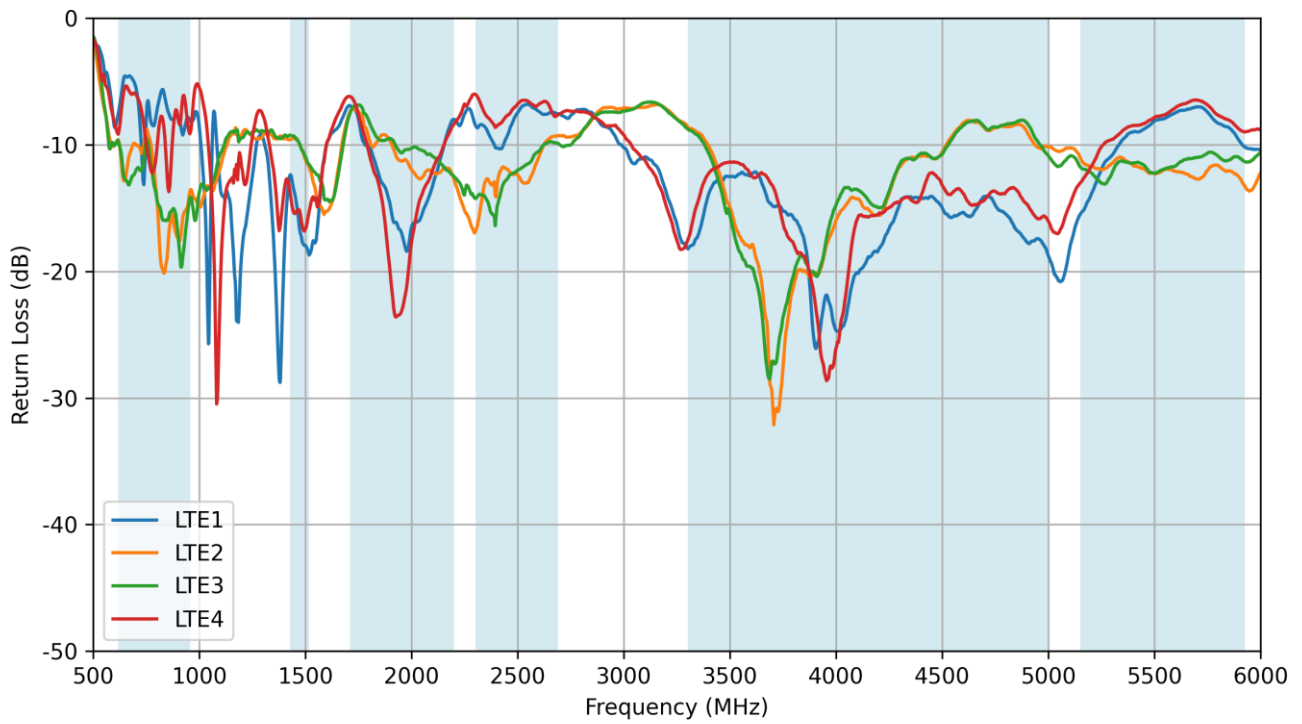

5.7 LTE - VSWR

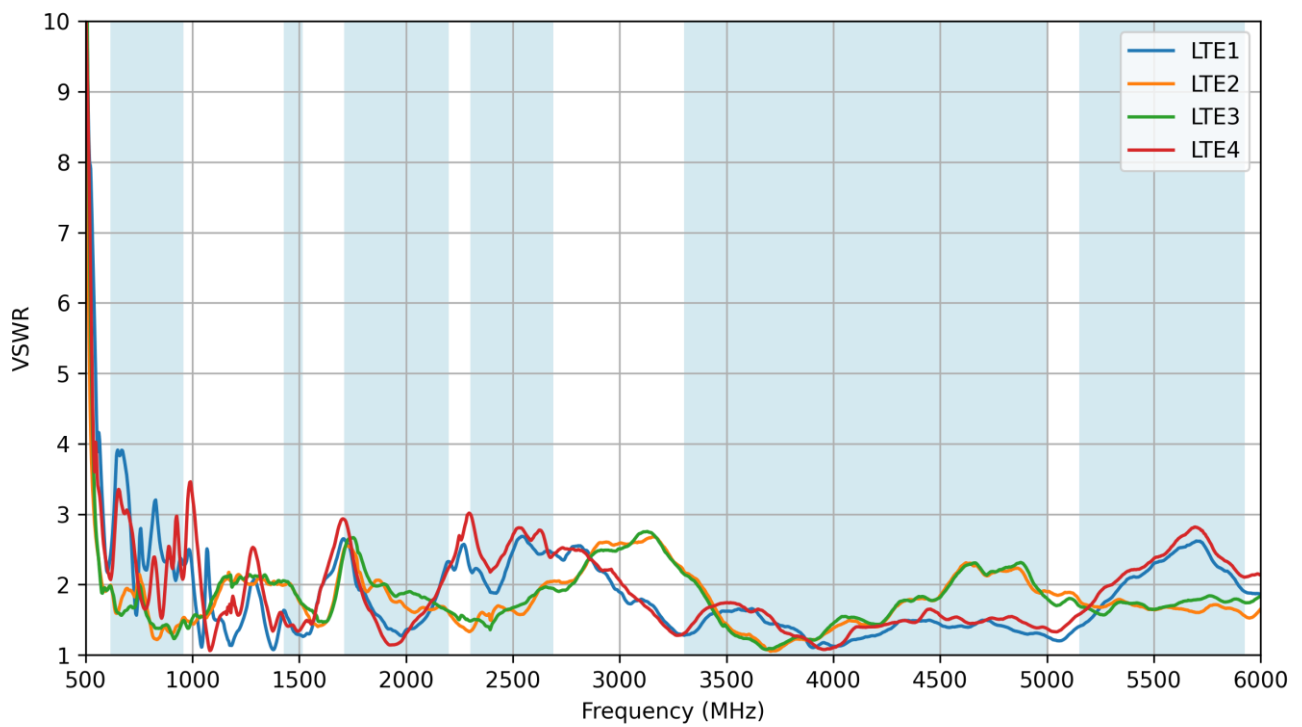

5.8 LTE - Isolation

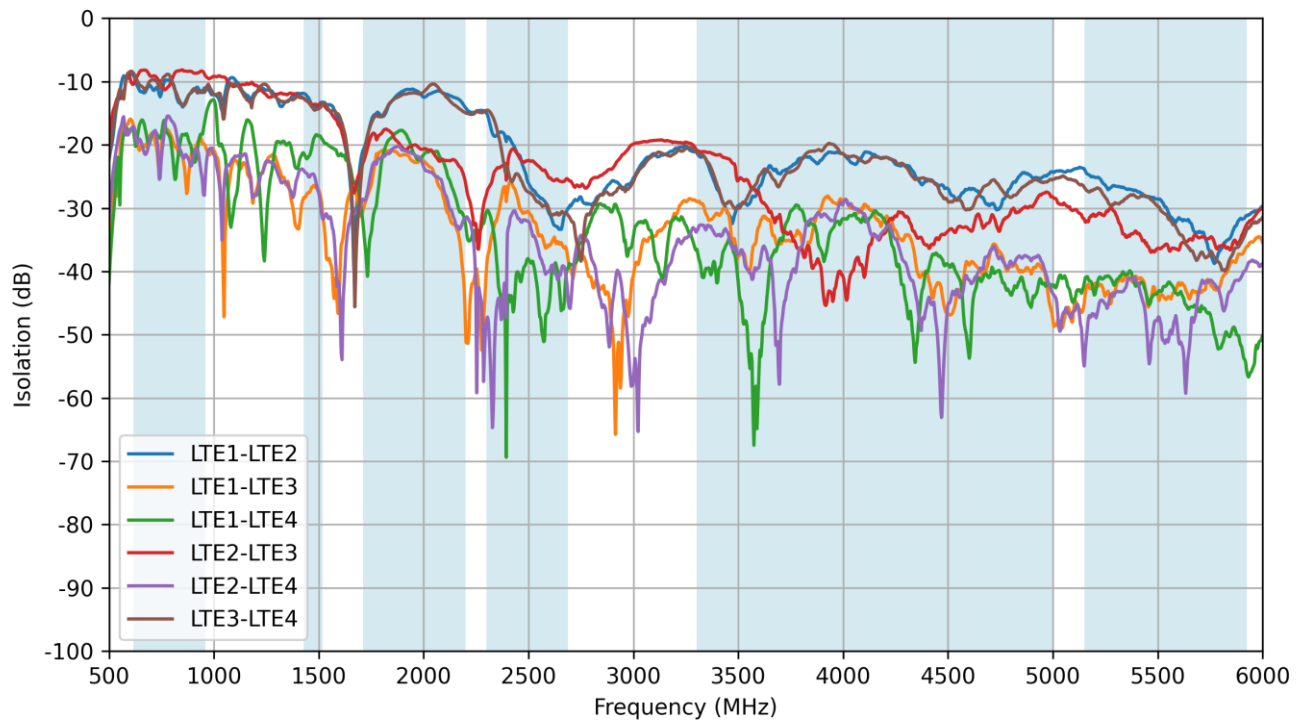

5.9 LTE - Efficiency

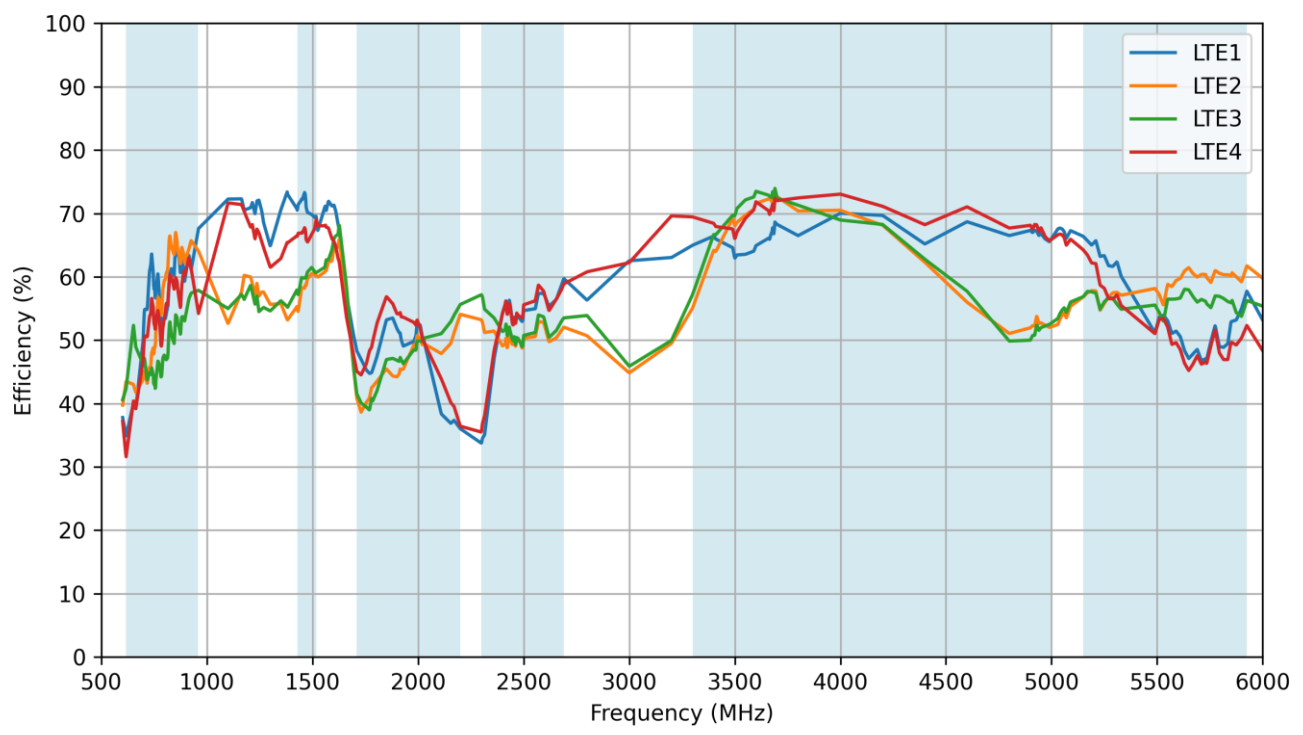

5.10 LTE - Average Gain

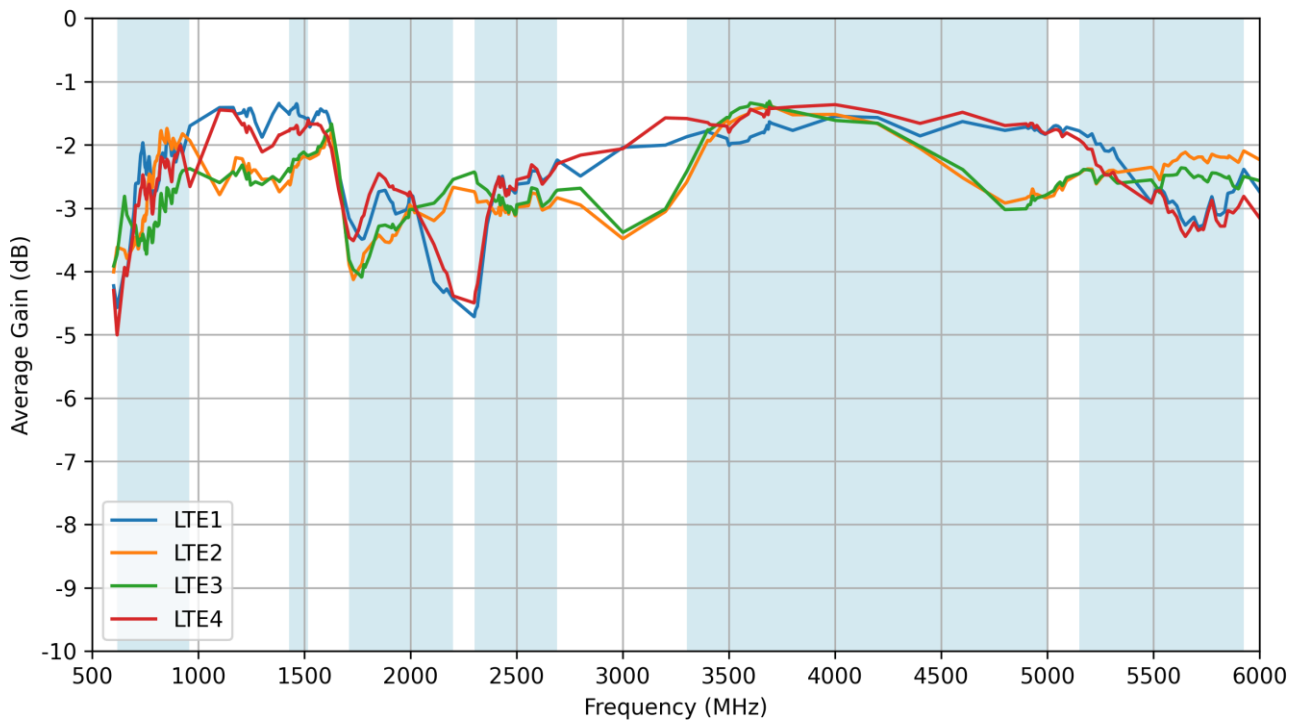

5.11 LTE - Peak Gain

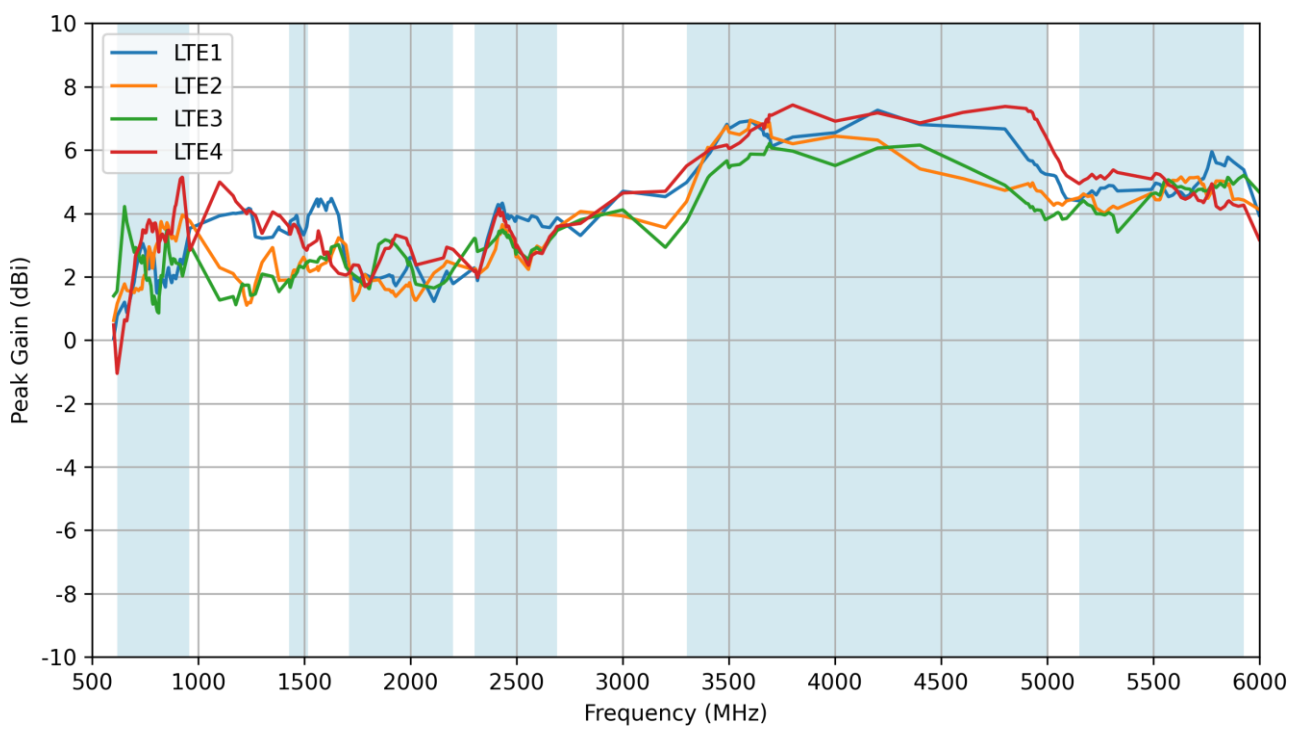

5.12 Wi-Fi - Return Loss

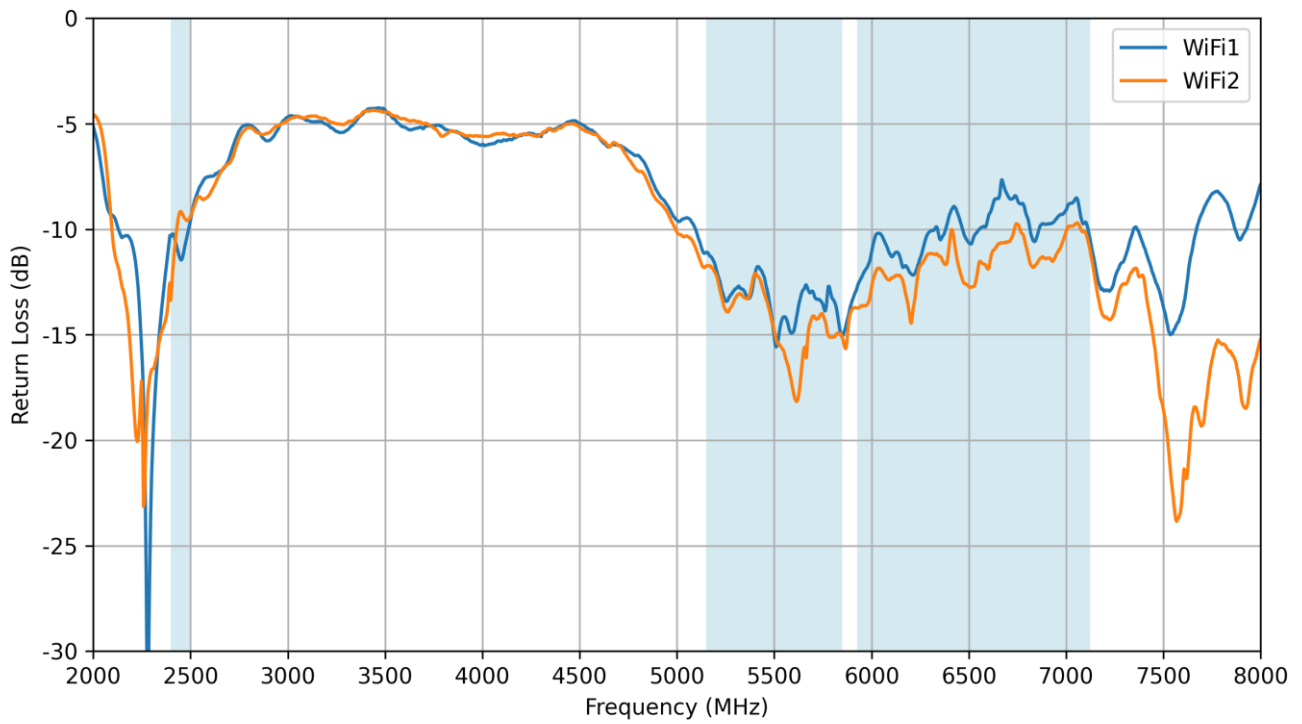

5.13 Wi-Fi - VSWR

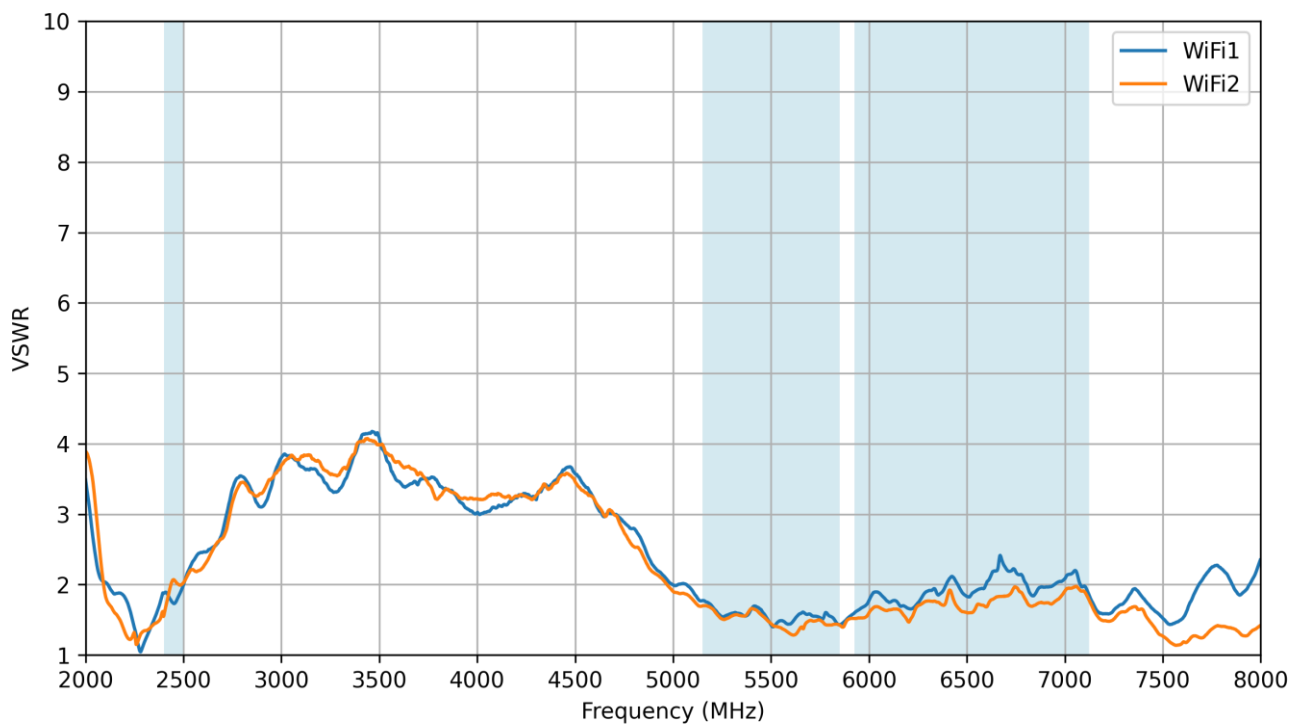

5.14 Wi-Fi - Isolation

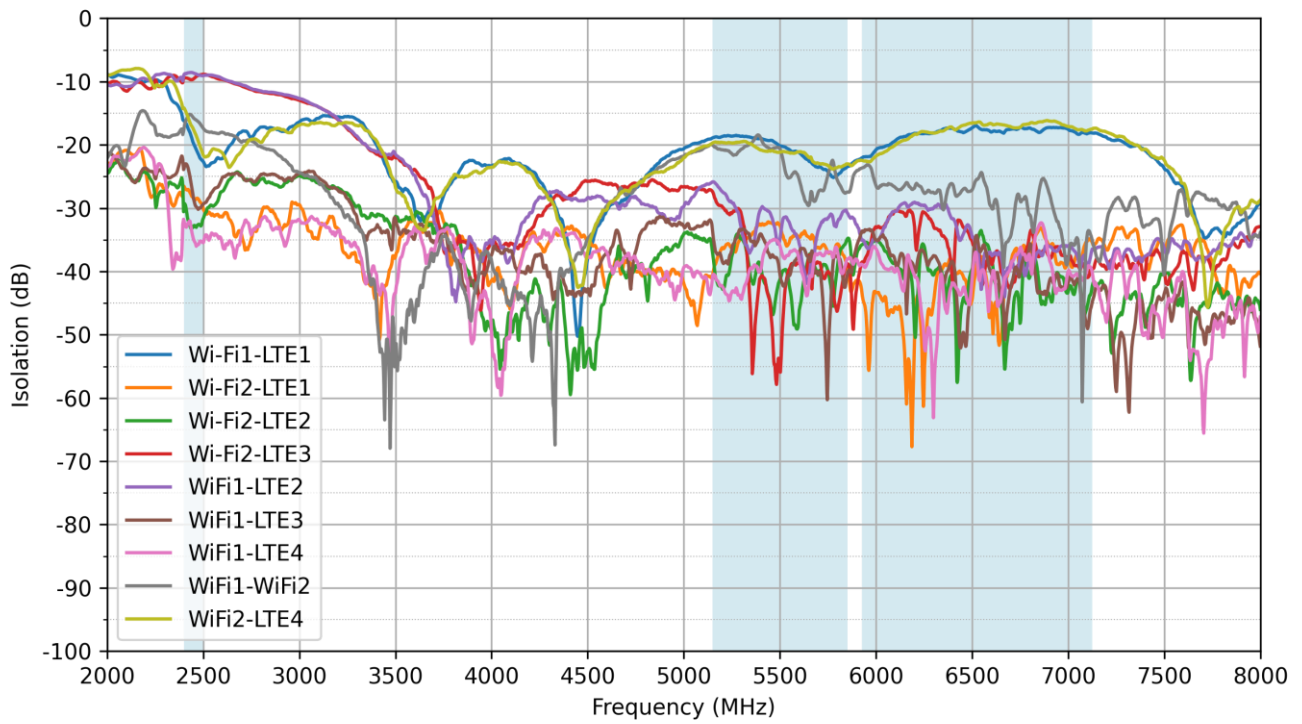

5.15 Wi-Fi - Efficiency

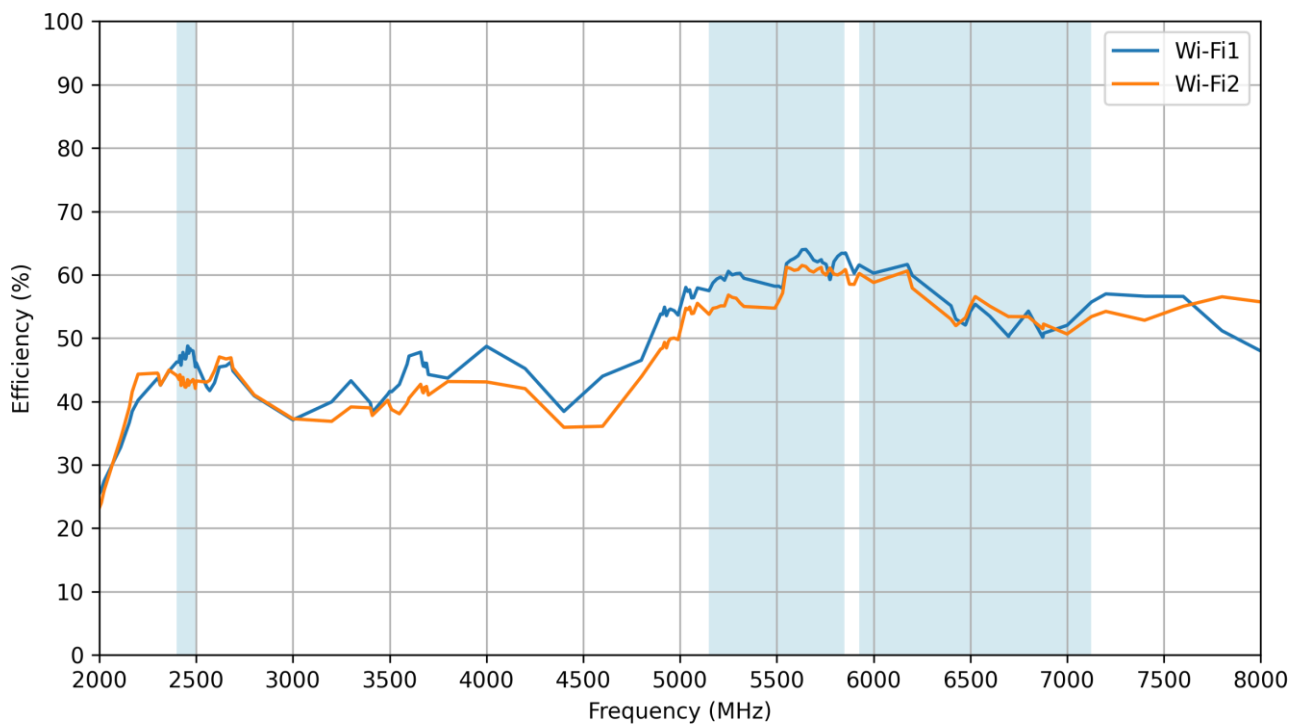

5.16 Wi-Fi - Average Gain

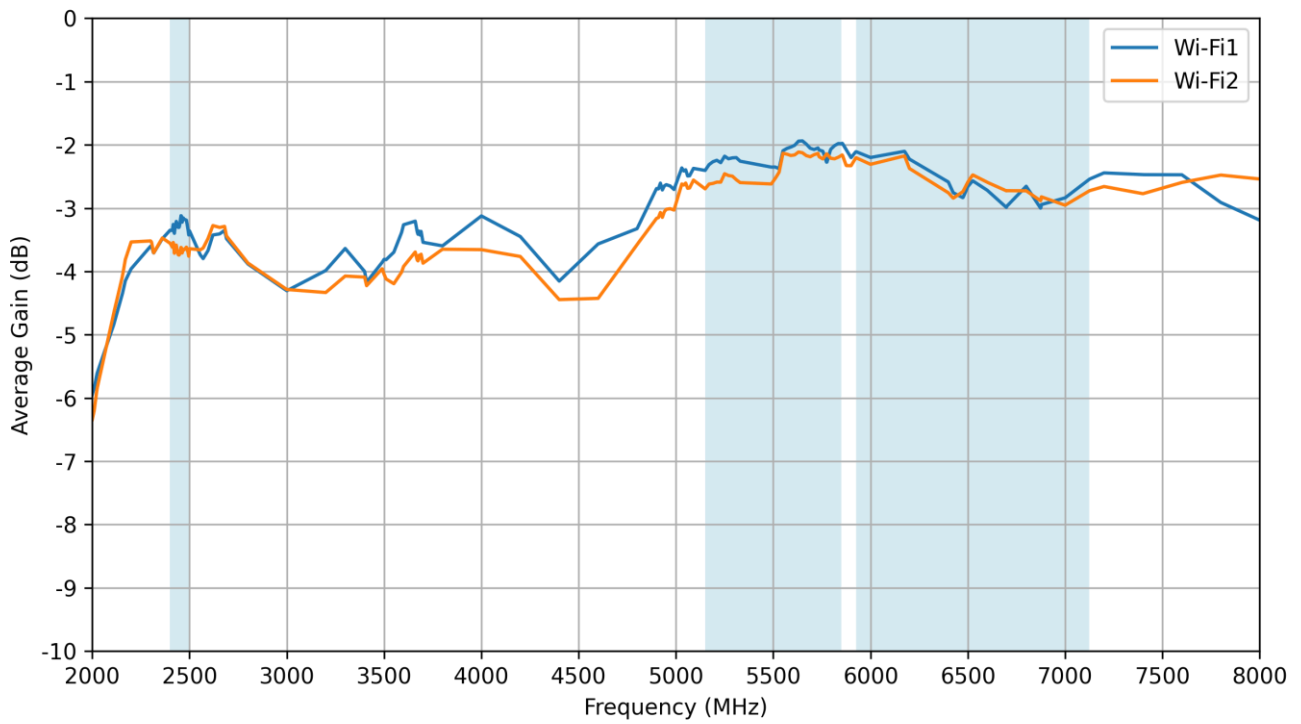

5.17 Wi-Fi - Peak Gain

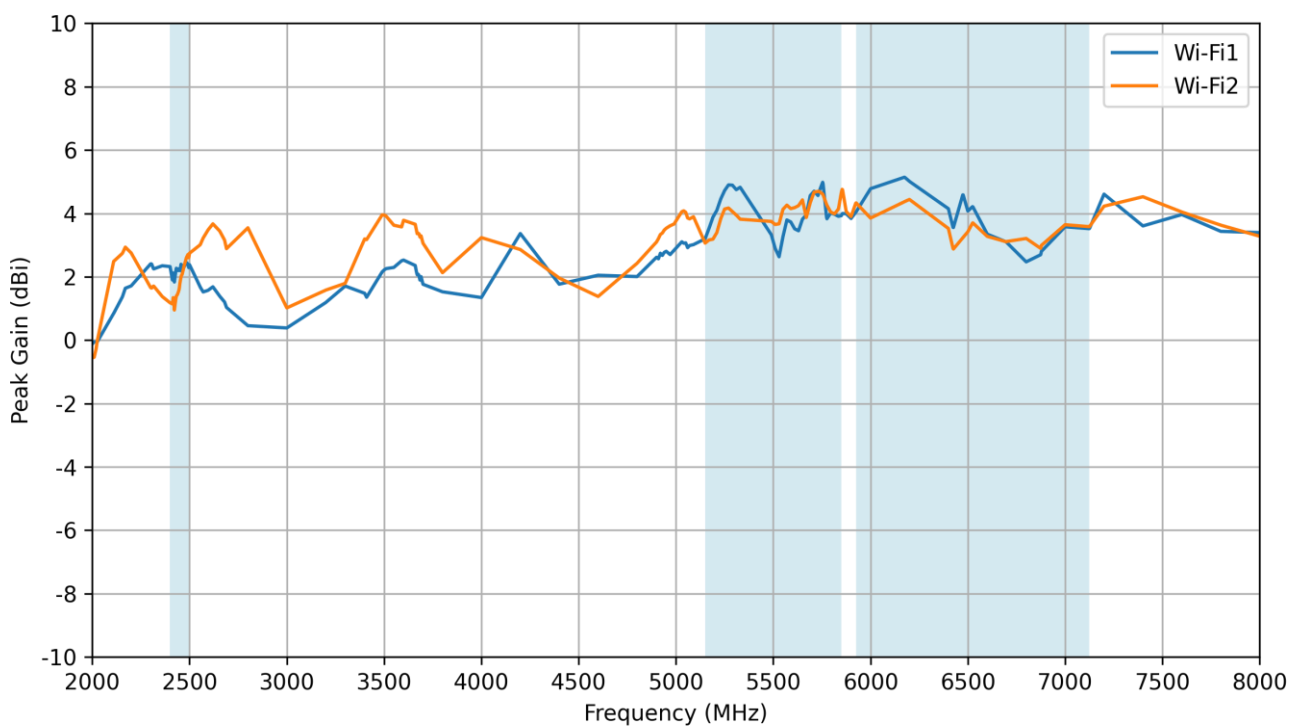

6. LNA Characteristics

6.1 Block Diagram



6.2 LNA Gain – Low-Band

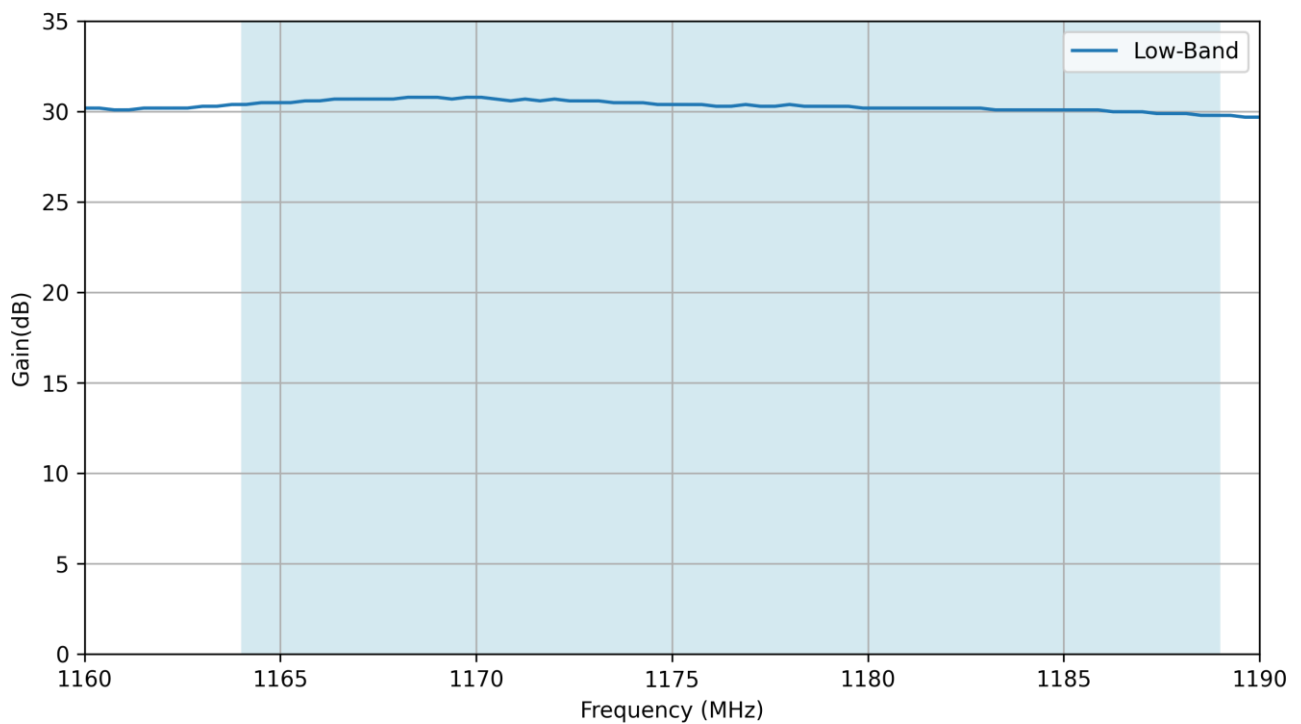

6.3 LNA Gain – High-Band

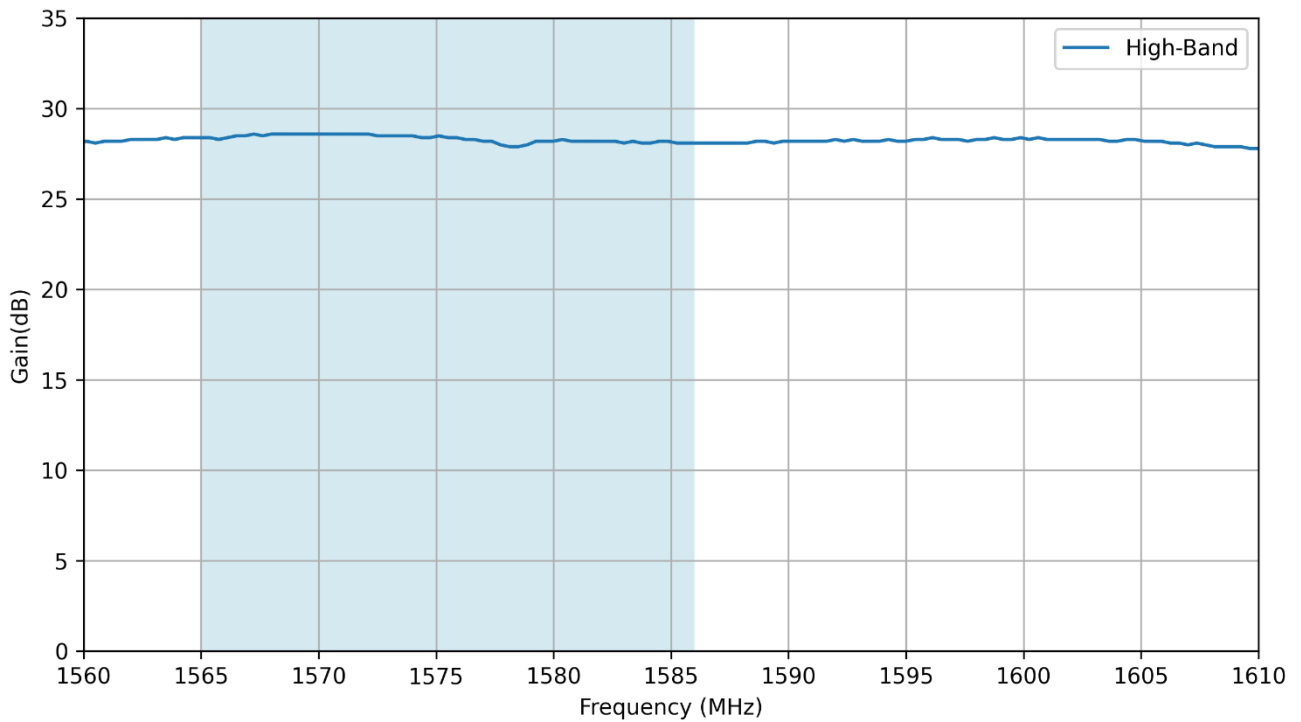

6.4 Noise Figure – Low-Band

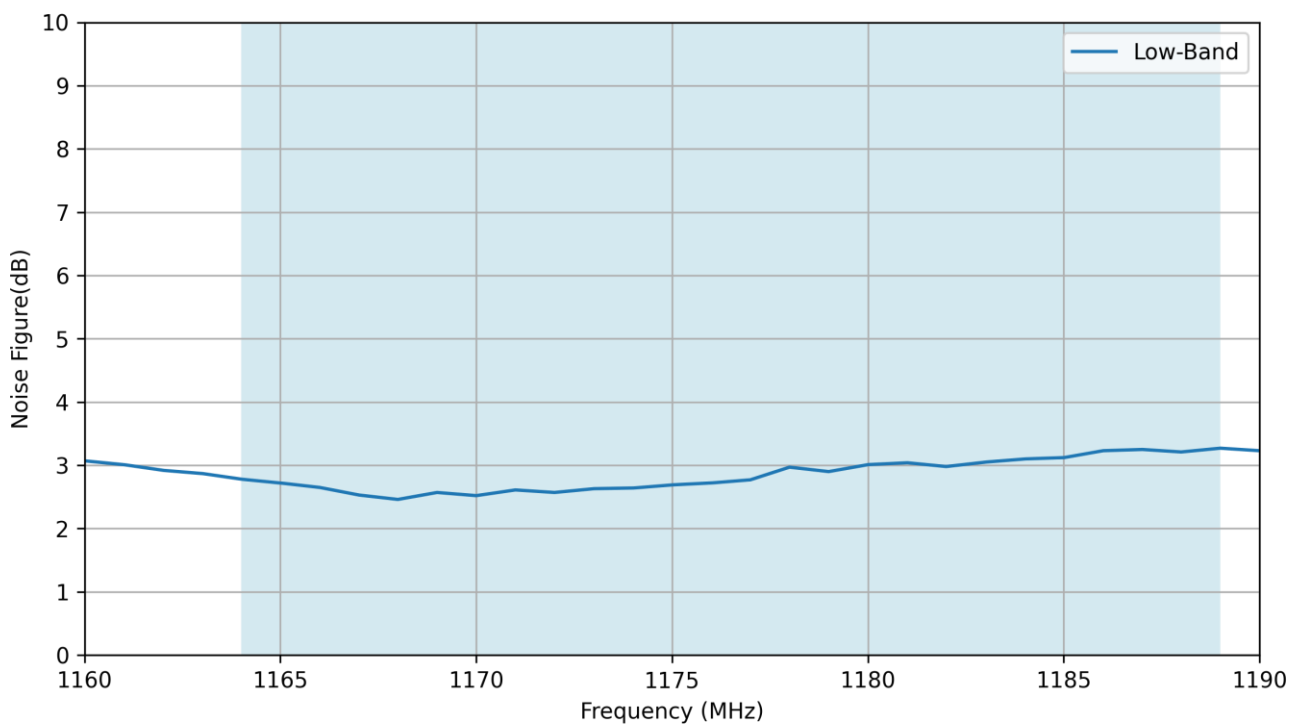

6.5 Noise Figure – High-Band

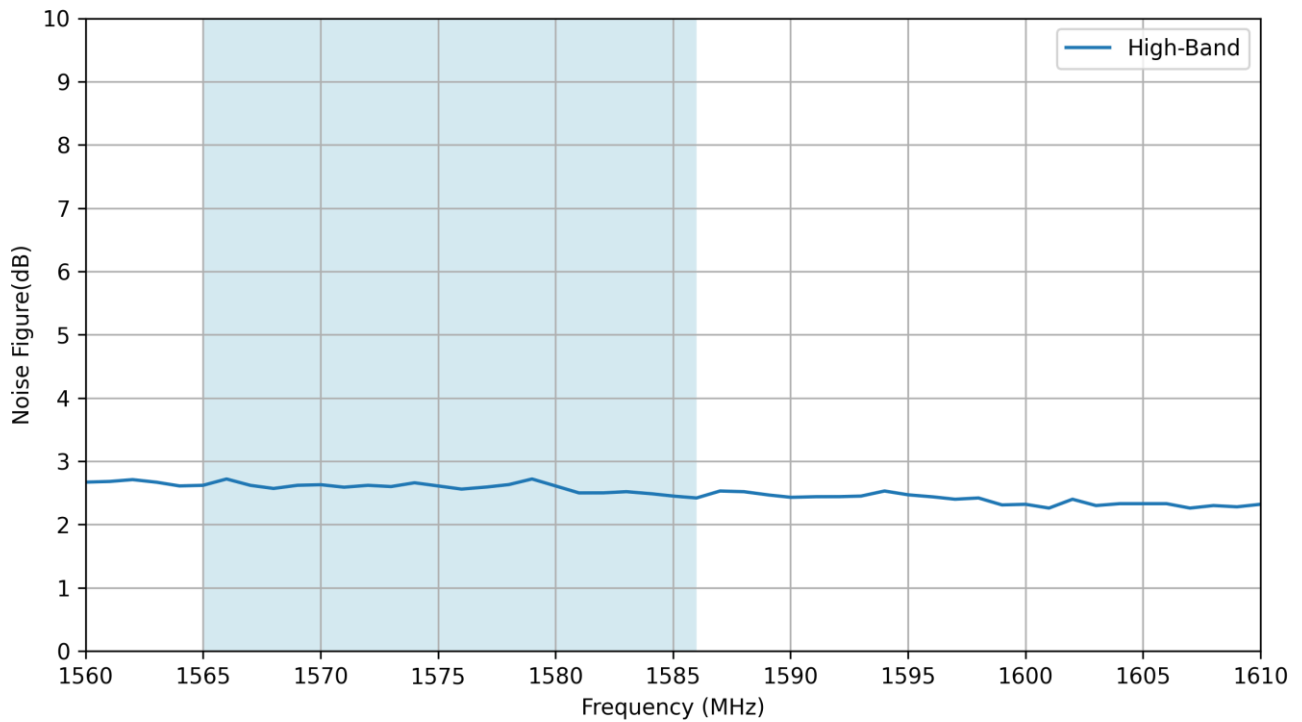

6.6 Out Of Band Rejection

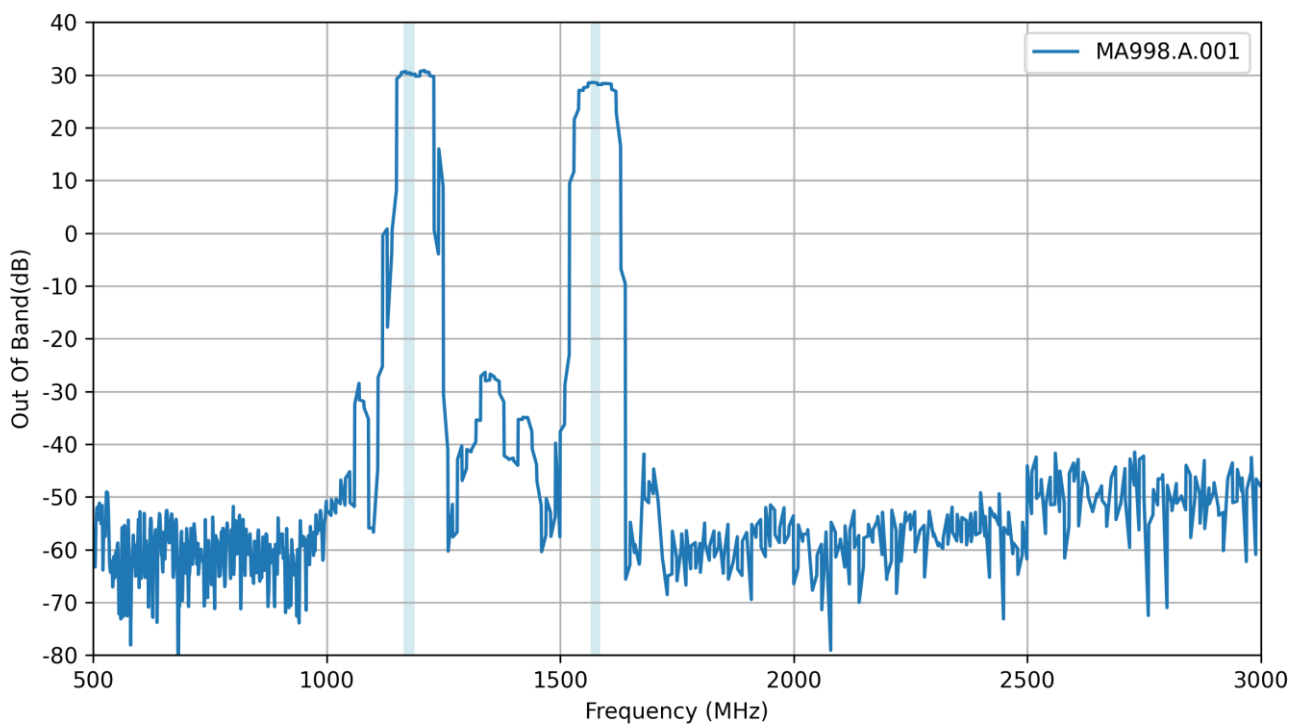

7. Radiation Patterns

7.1 Test Setup

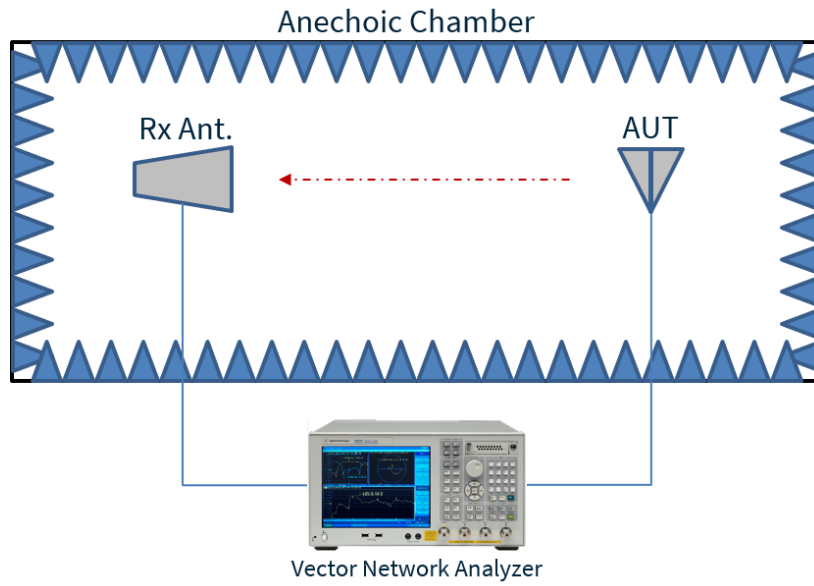

7.2 GNSS Patterns at 1176 MHz

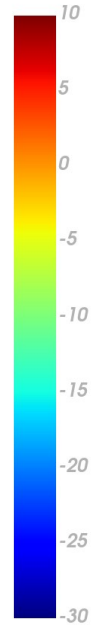
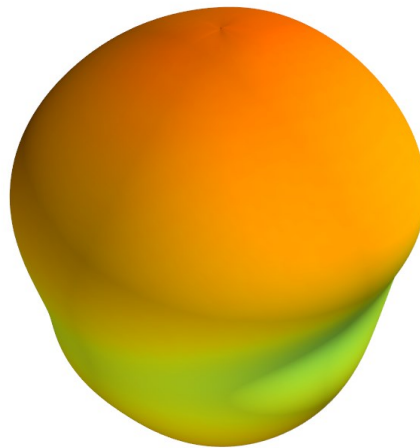

XZ Plane YZ Plane XY Plane

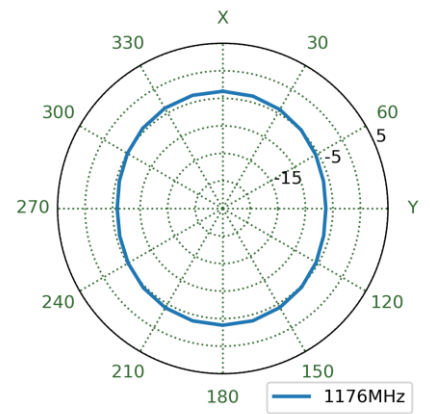
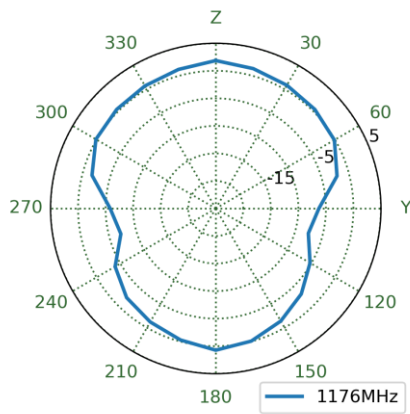
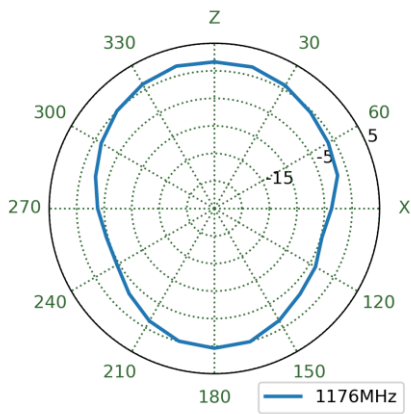

7.3 GNSS Patterns at 1561 MHz

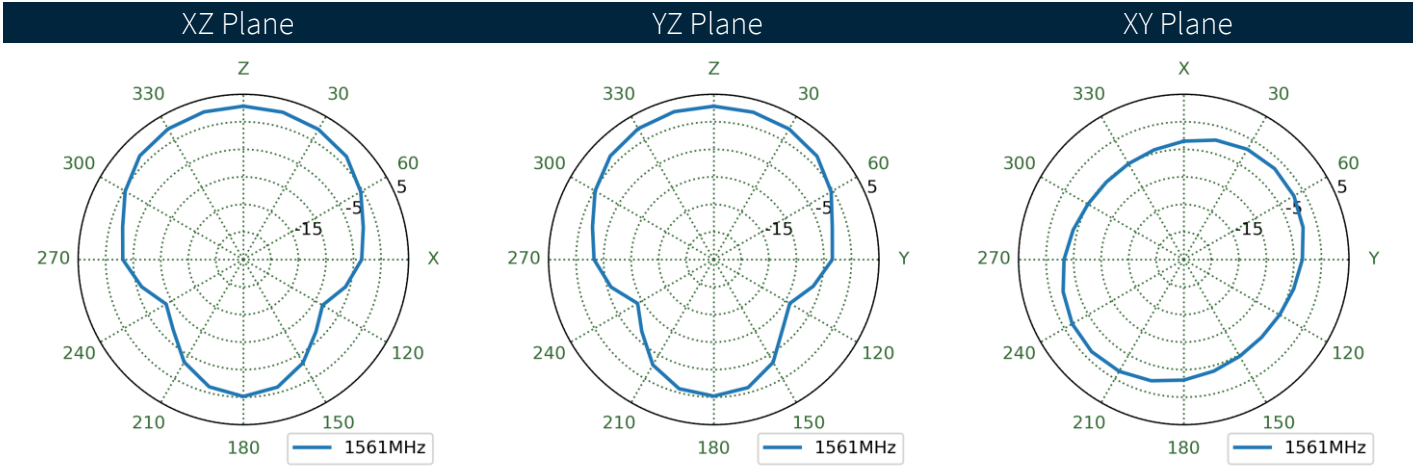
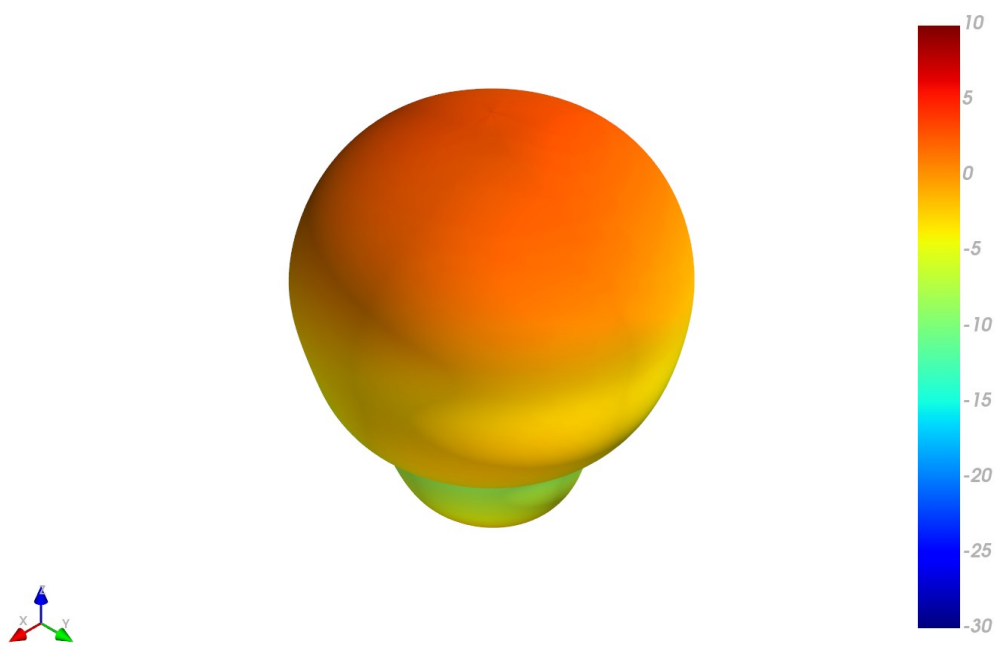

7.4 GNSS Patterns at 1575 MHz

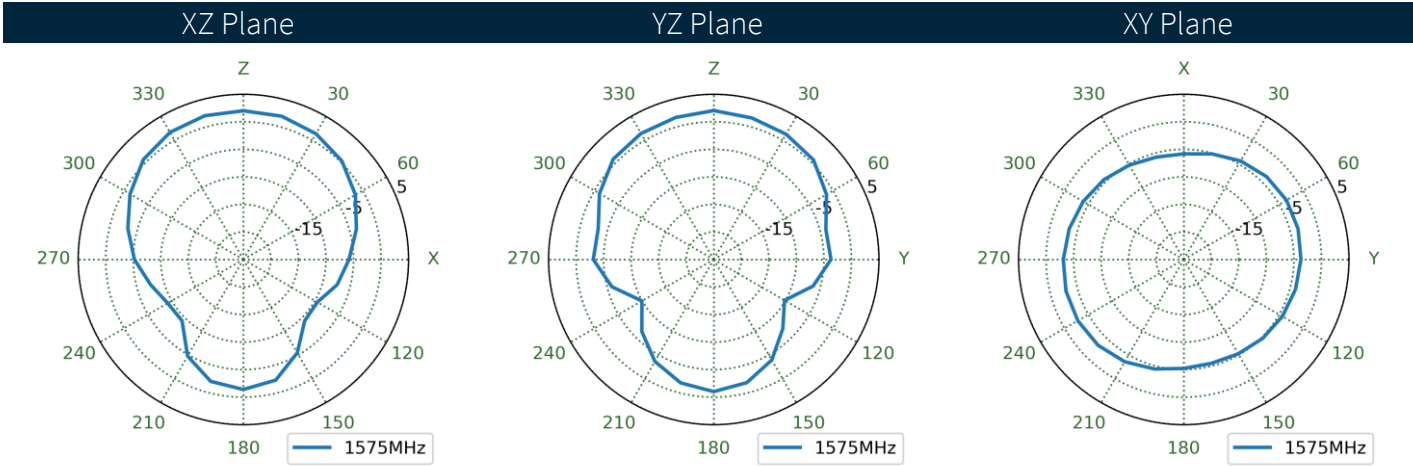
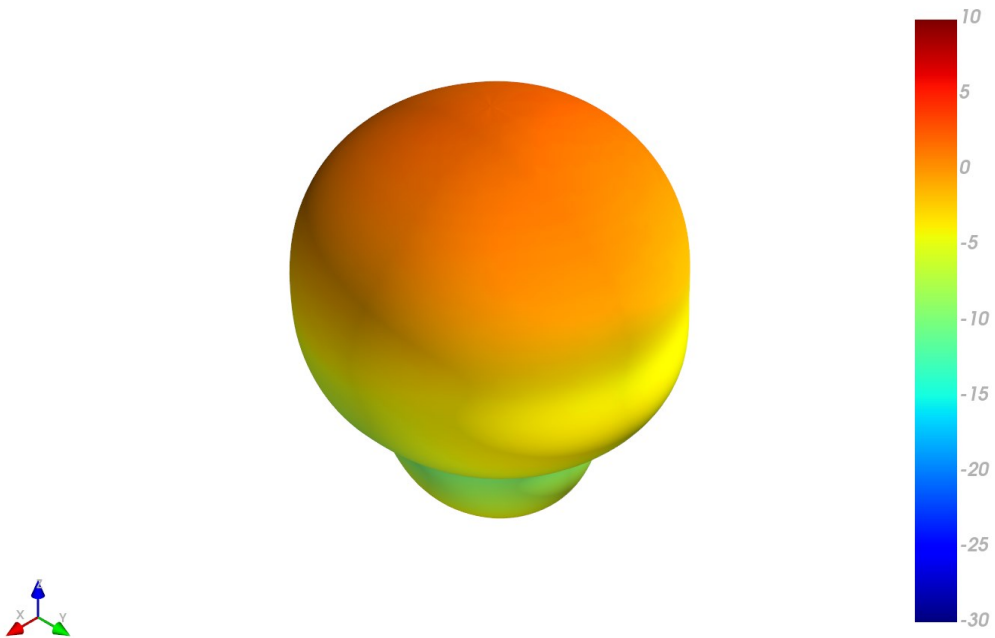

7.5 GNSS Patterns at 1602 MHz

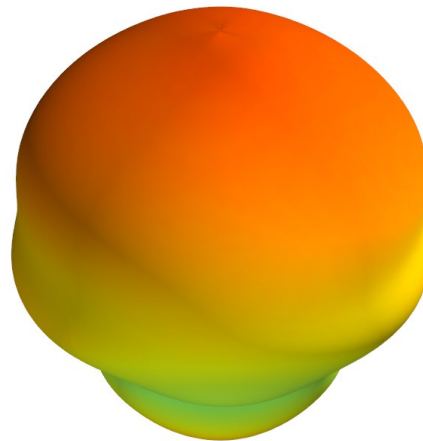

XZ Plane YZ Plane XY Plane

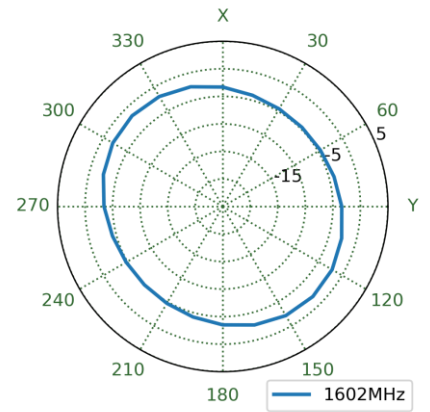
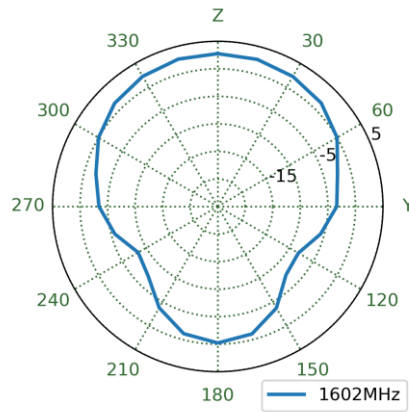
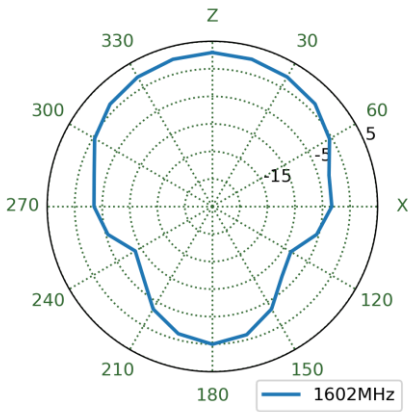

7.6 LTE1 Patterns at 650 MHz

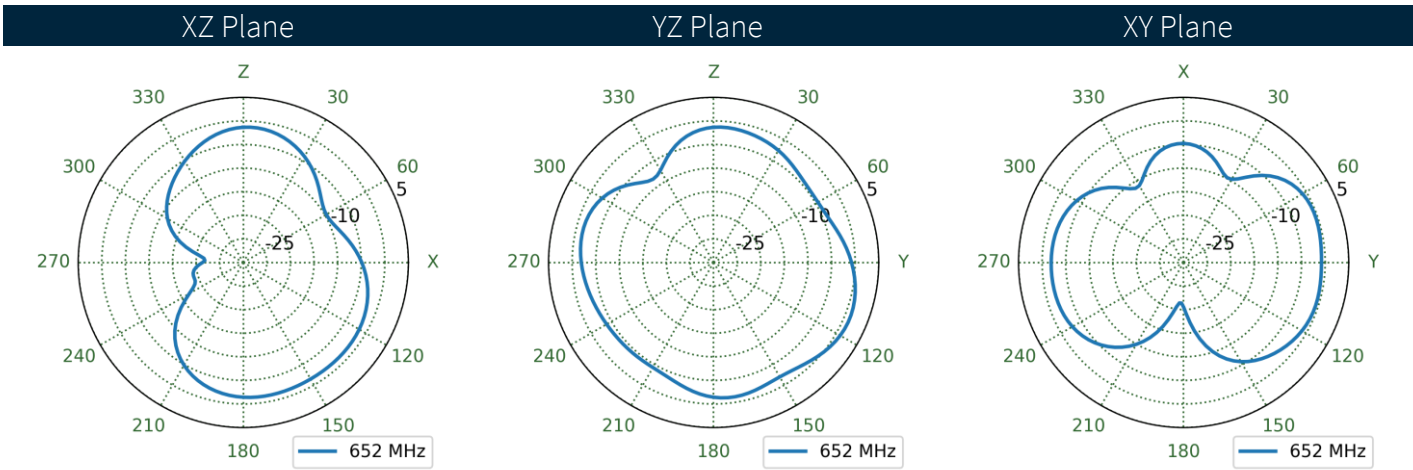
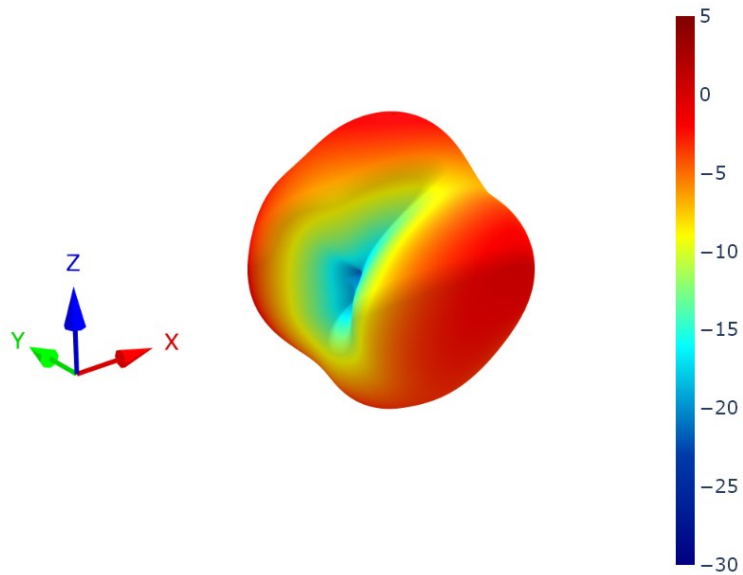

7.7 LTE2 Patterns at 650 MHz

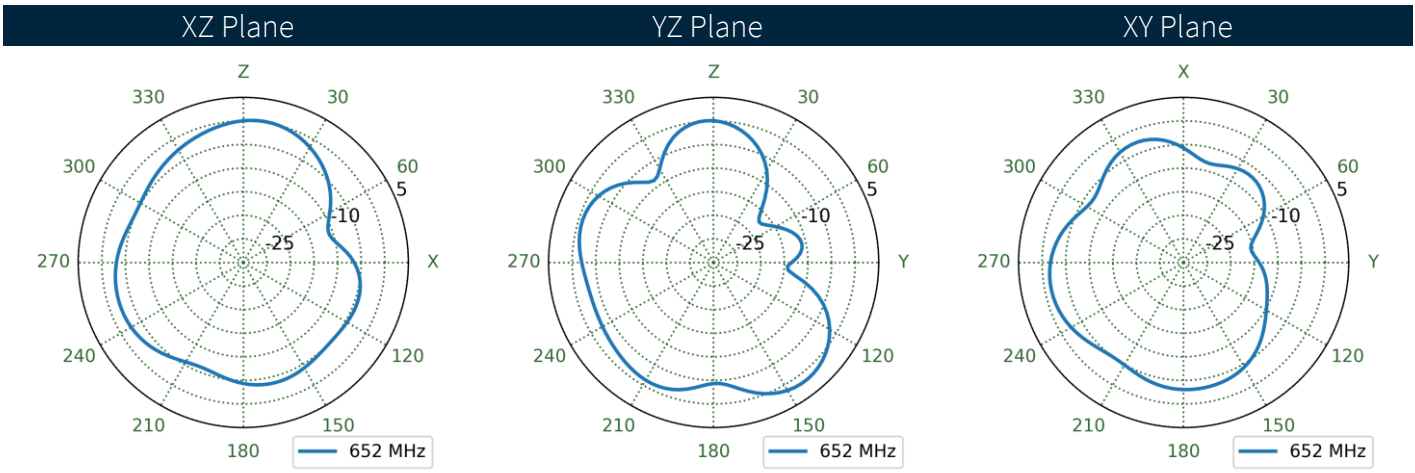
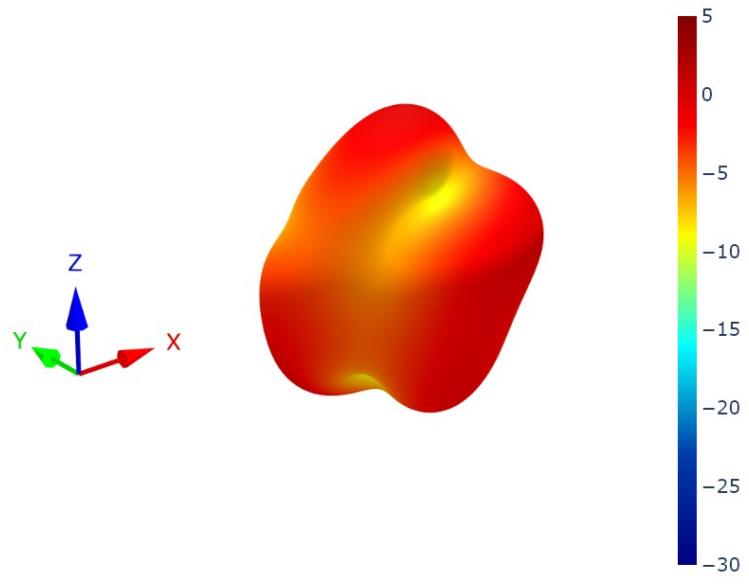

7.8 LTE3 Patterns at 650 MHz

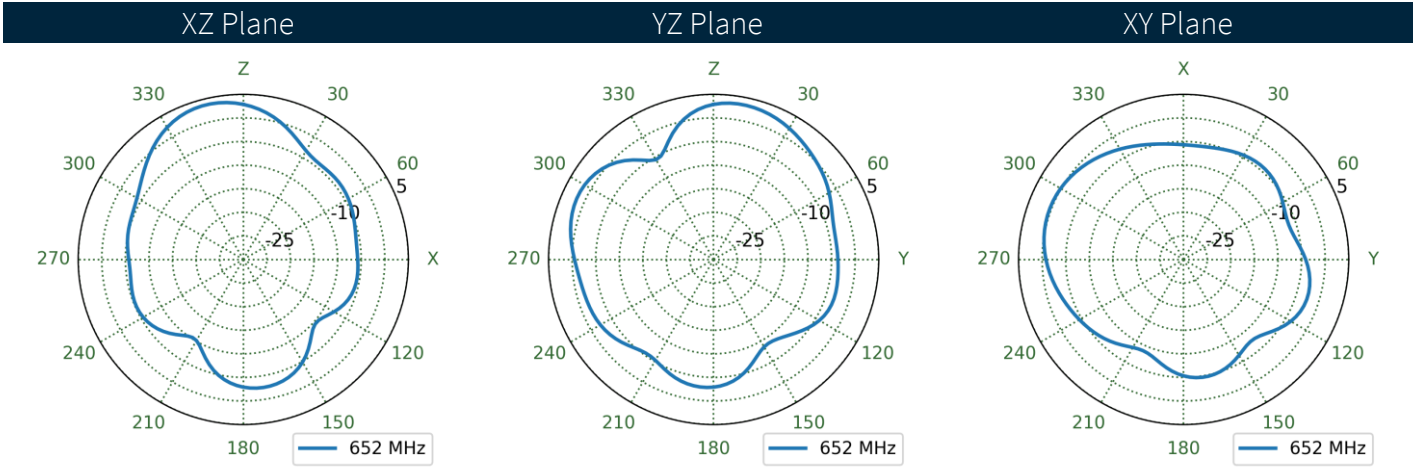
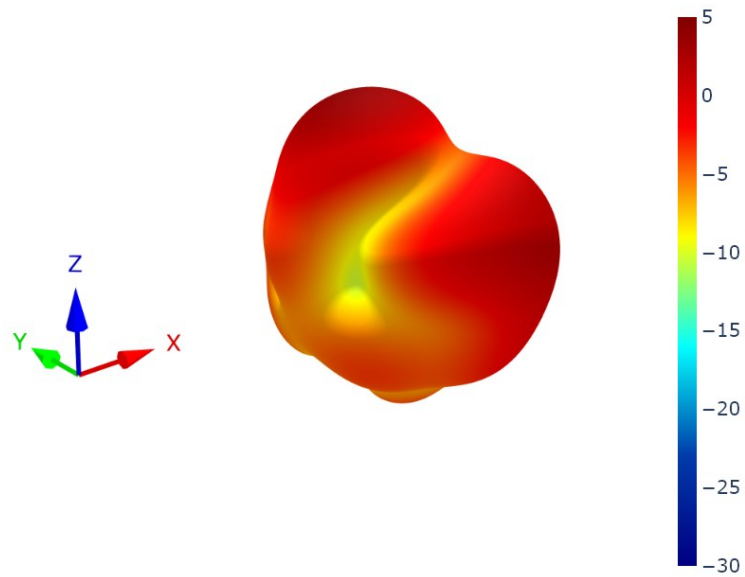

7.9 LTE4 Patterns at 650 MHz

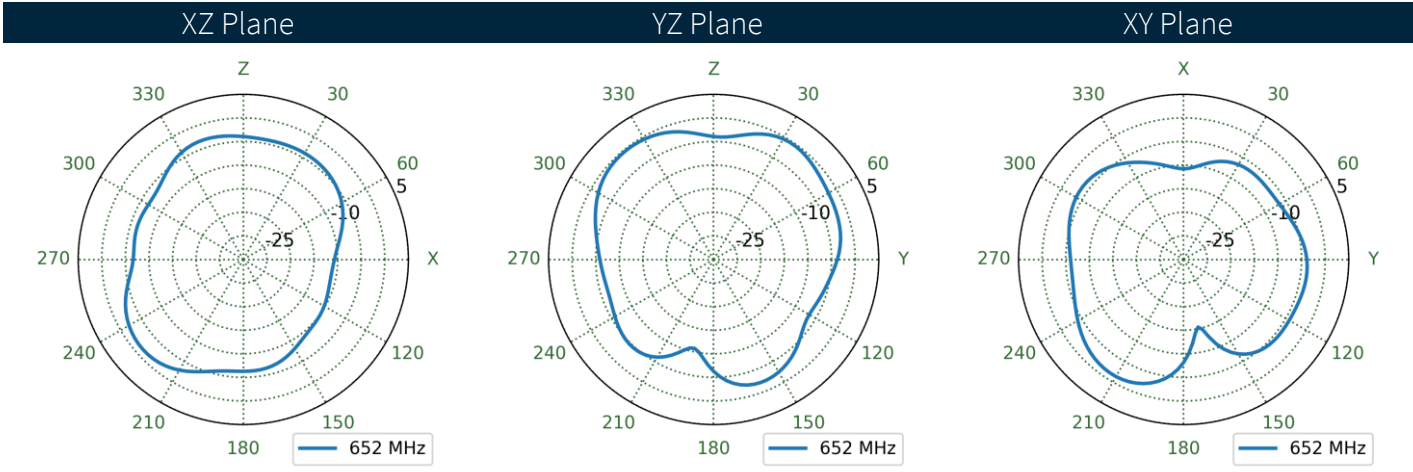
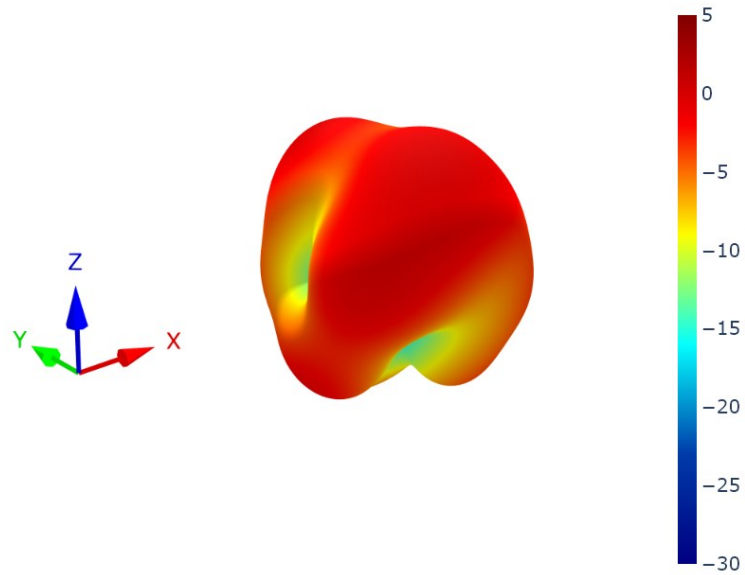

7.10 LTE1 Patterns at 750 MHz

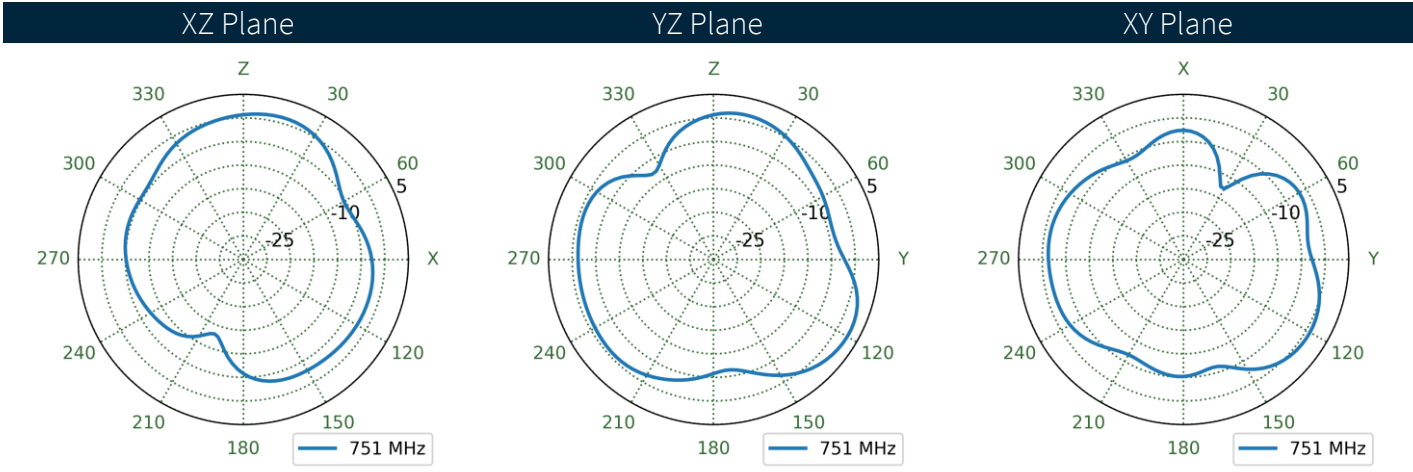
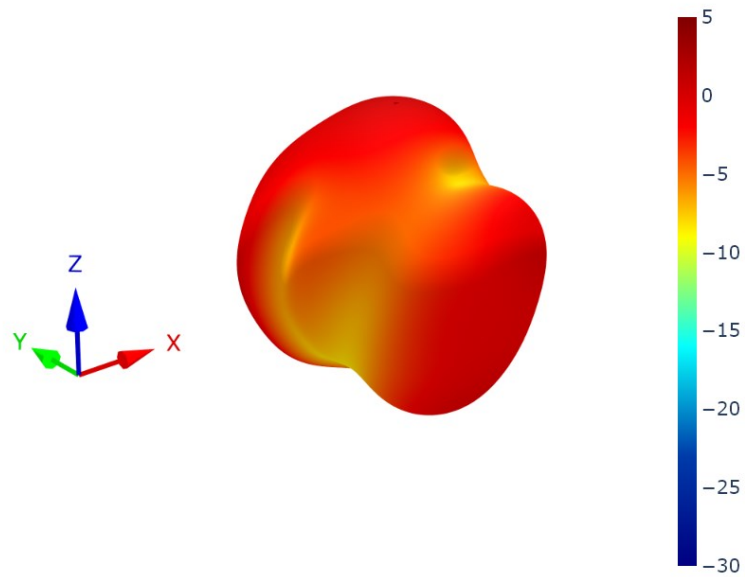

7.11 LTE2 Patterns at 750 MHz

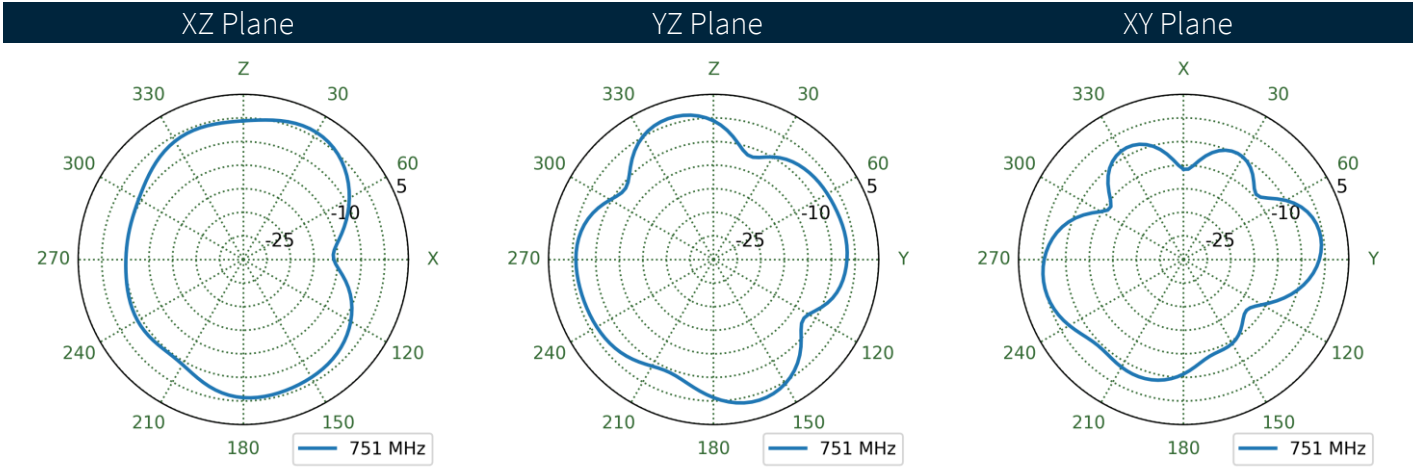
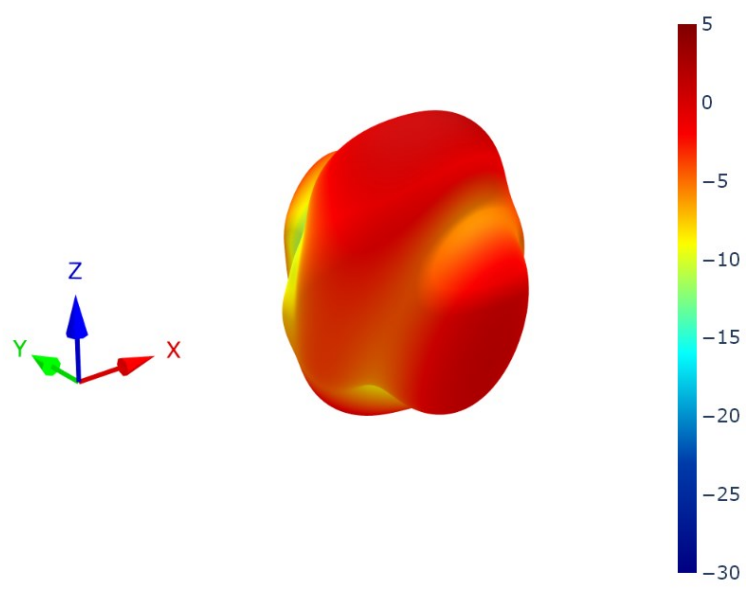

7.12 LTE3 Patterns at 750 MHz

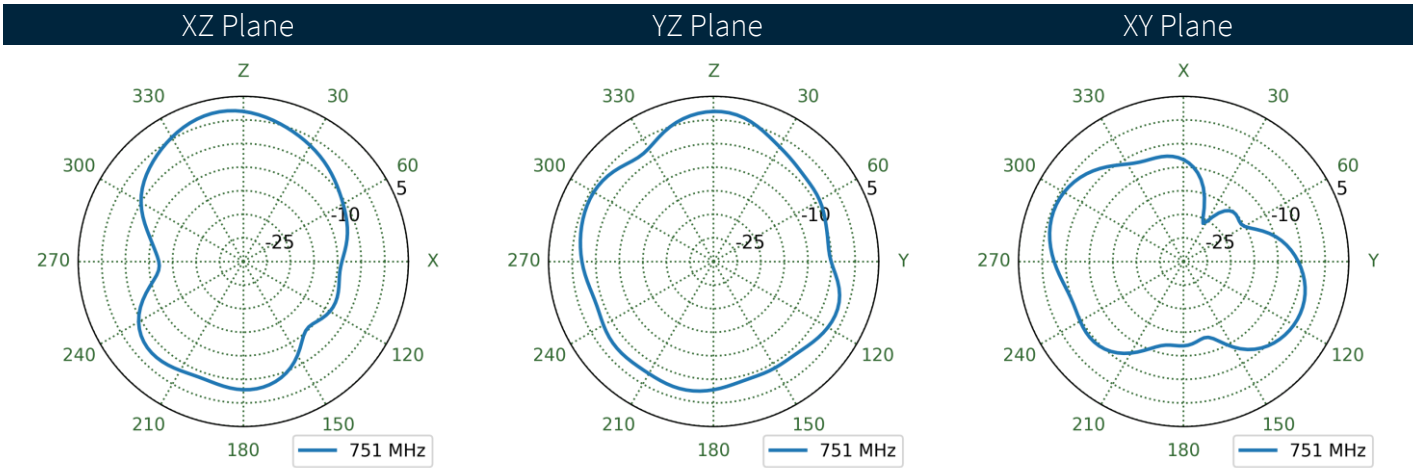
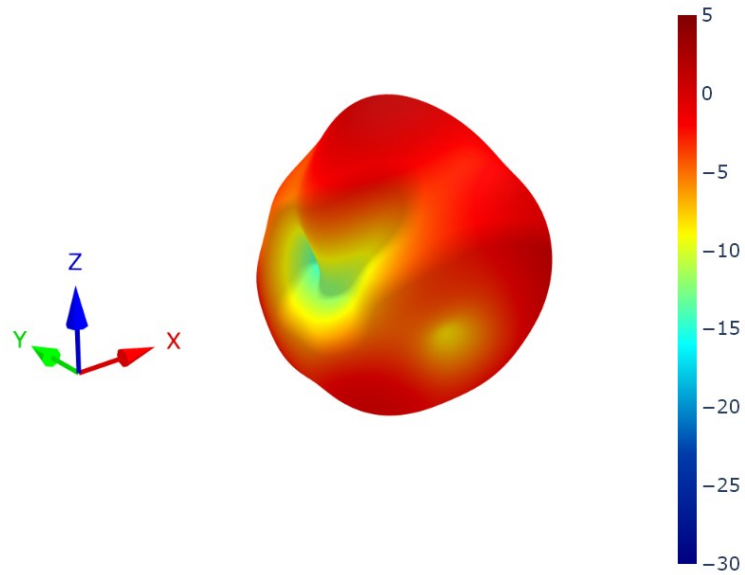

7.13 LTE4 Patterns at 750 MHz

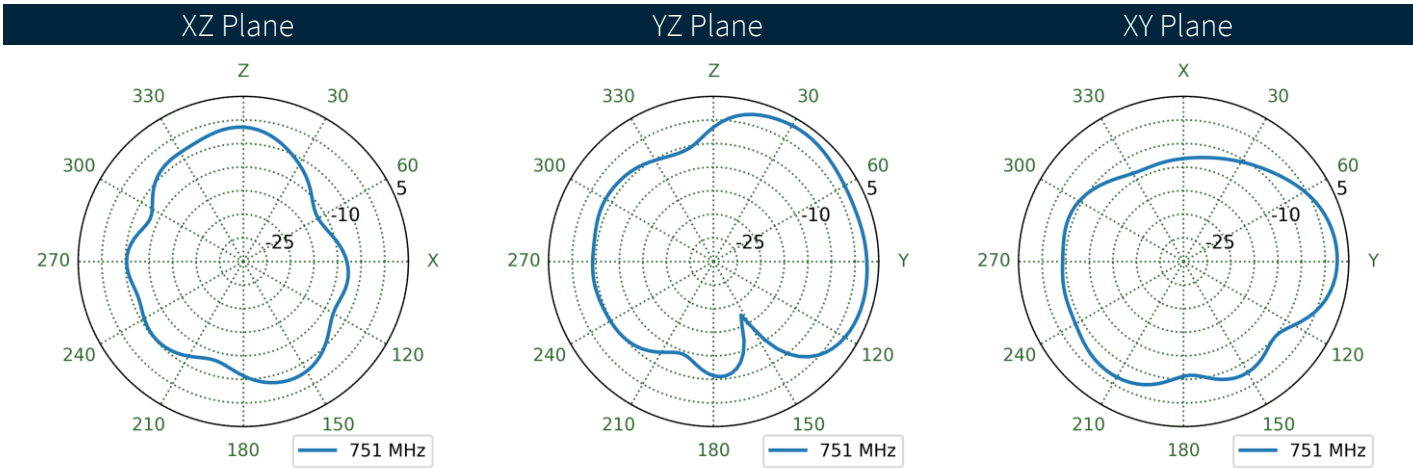
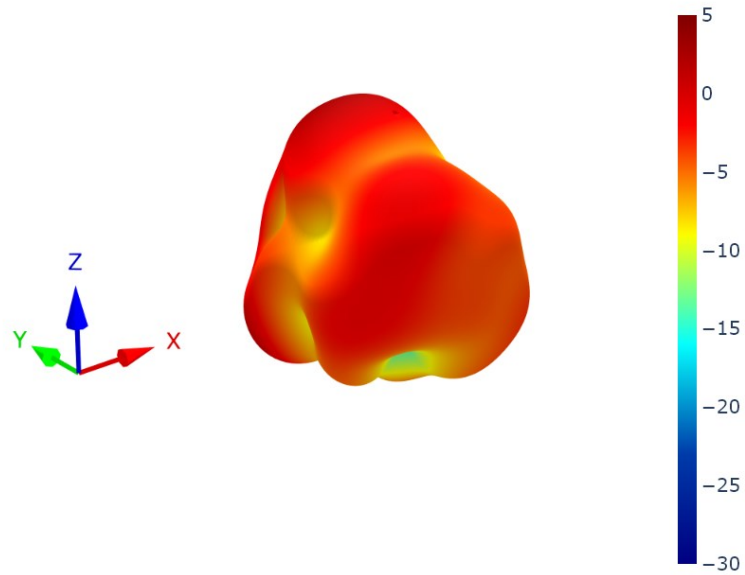

7.14 LTE1 Patterns at 890 MHz

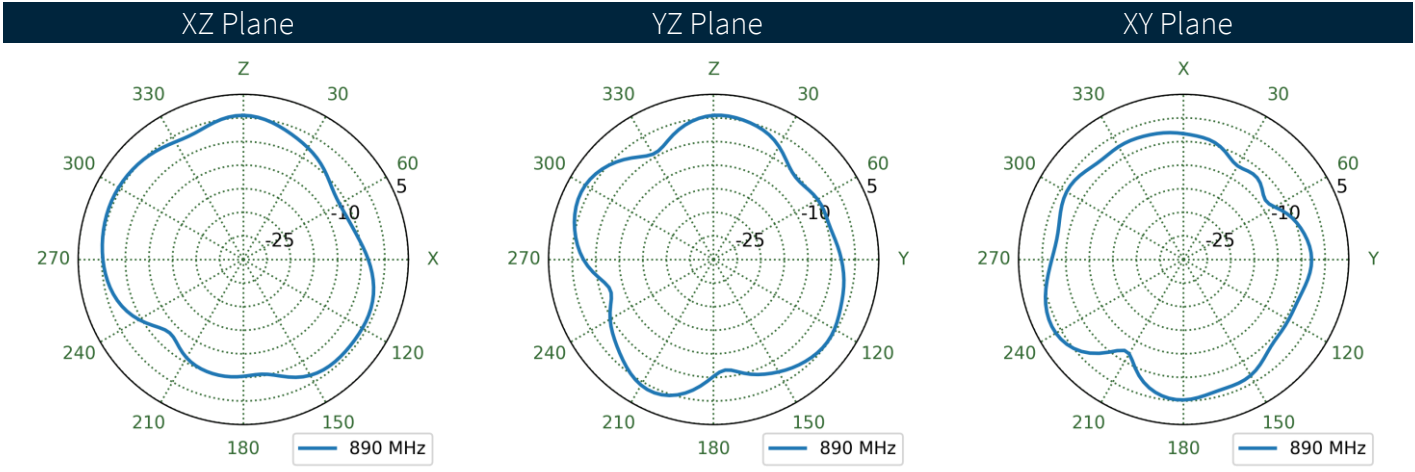
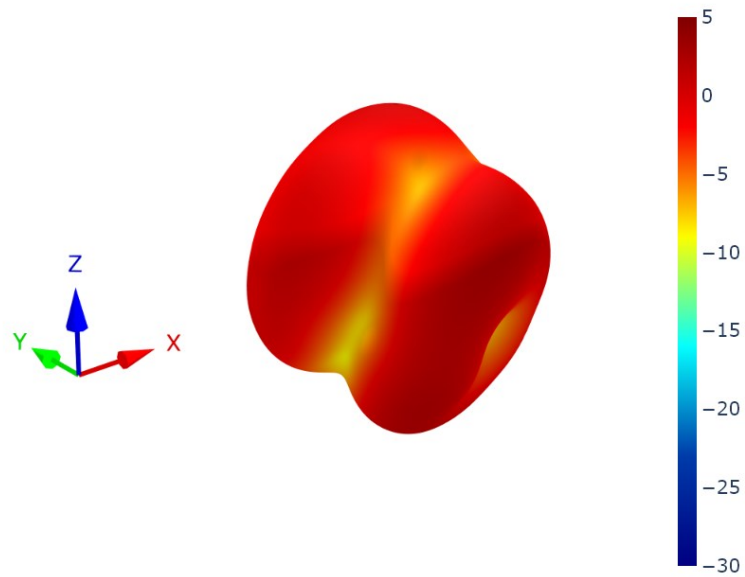

7.15 LTE2 Patterns at 890 MHz

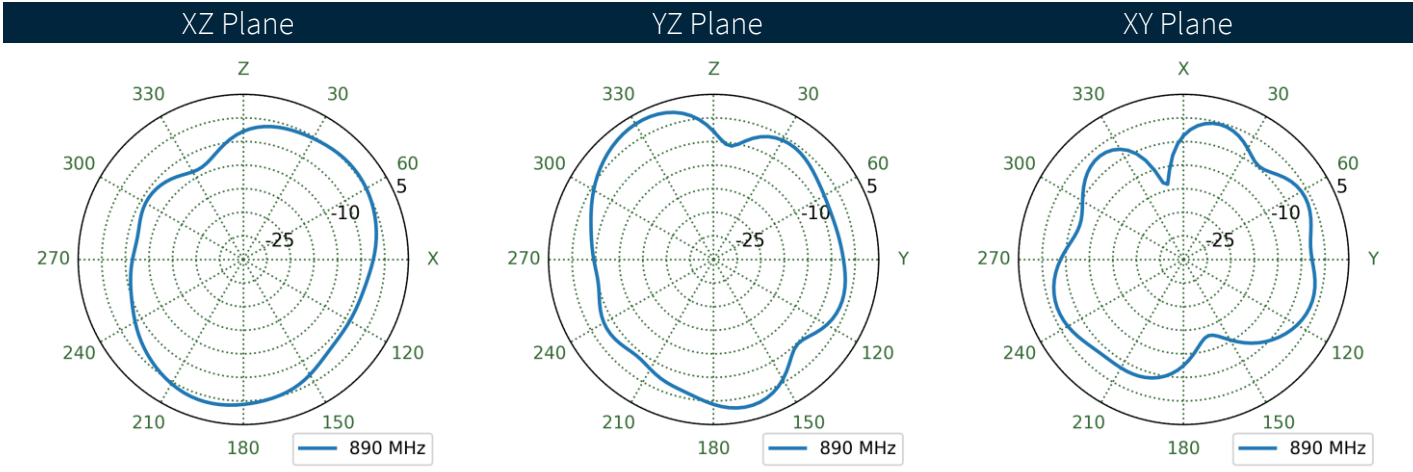
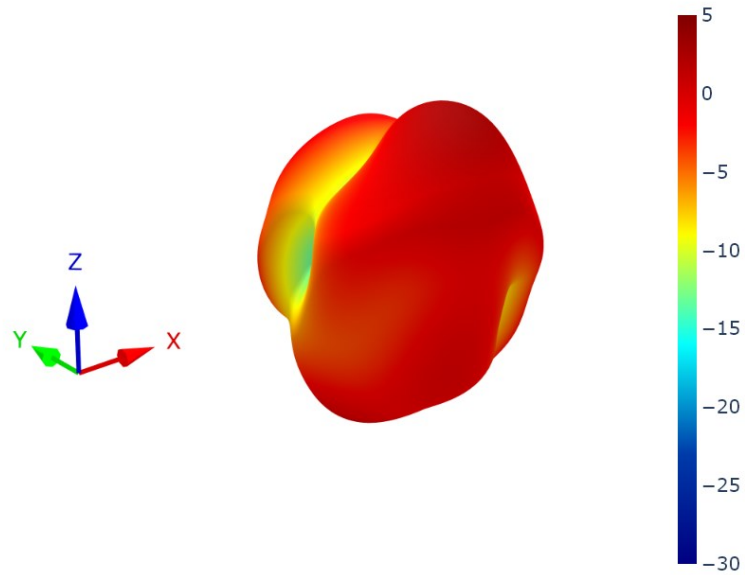

7.16 LTE3 Patterns at 890 MHz

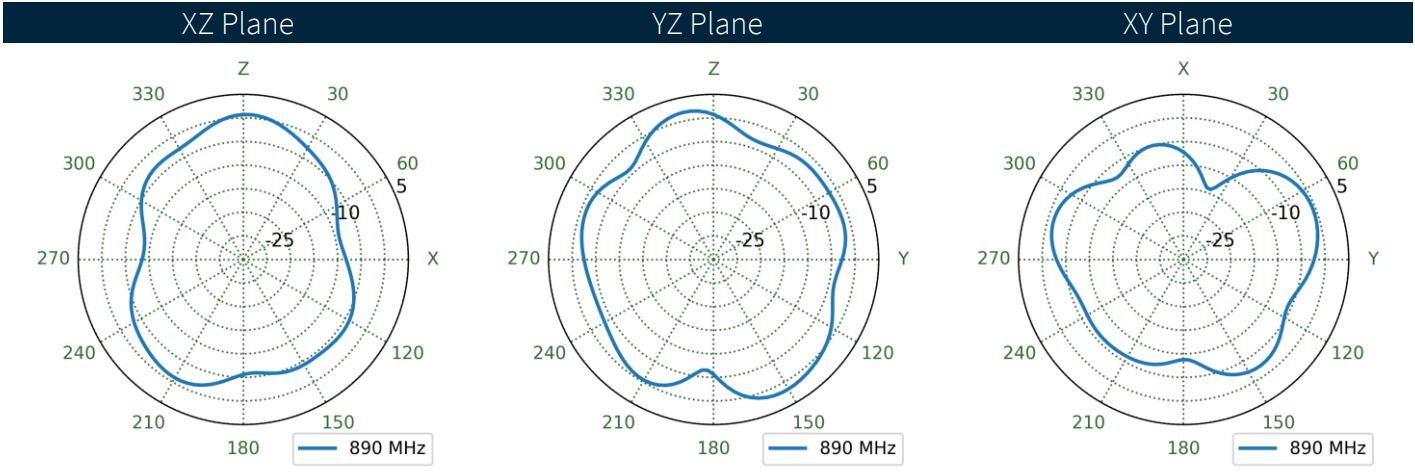
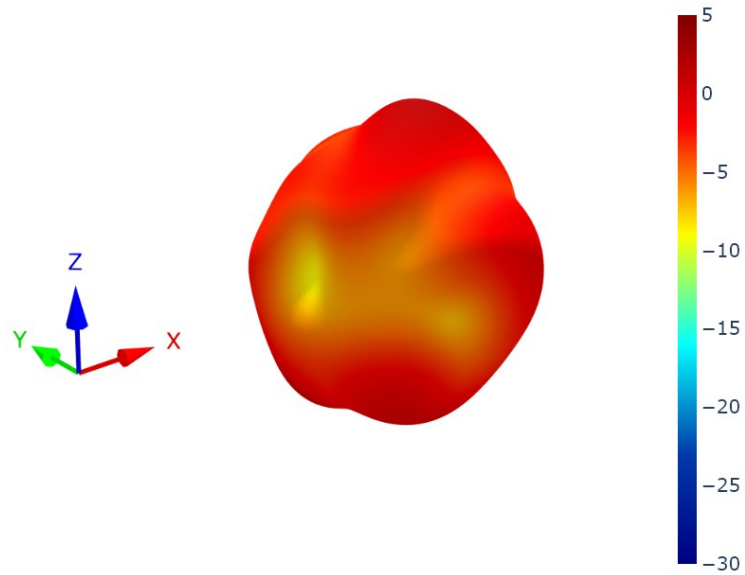

7.17 LTE4 Patterns at 890 MHz

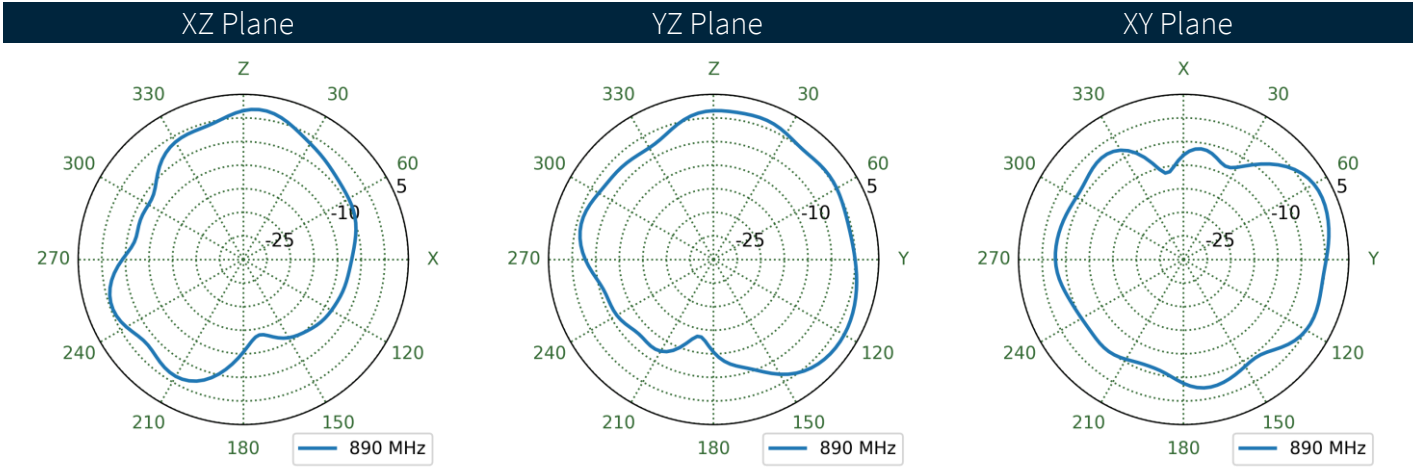
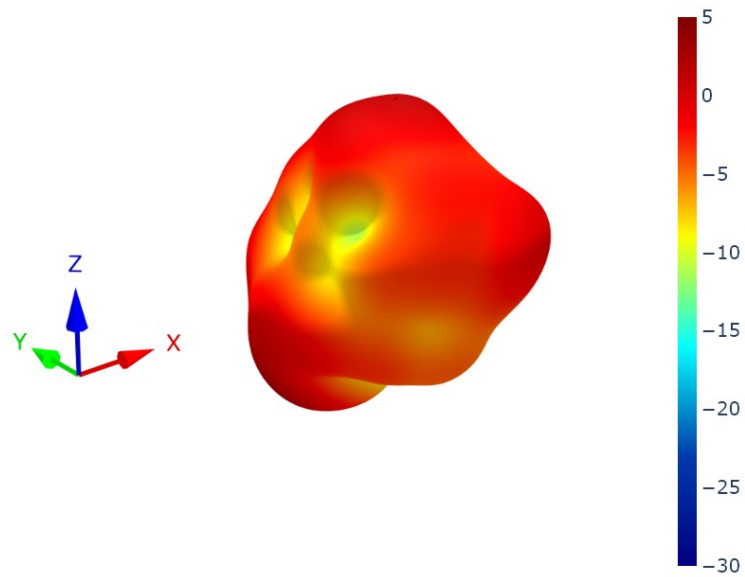

7.18 LTE1 Patterns at 1470 MHz

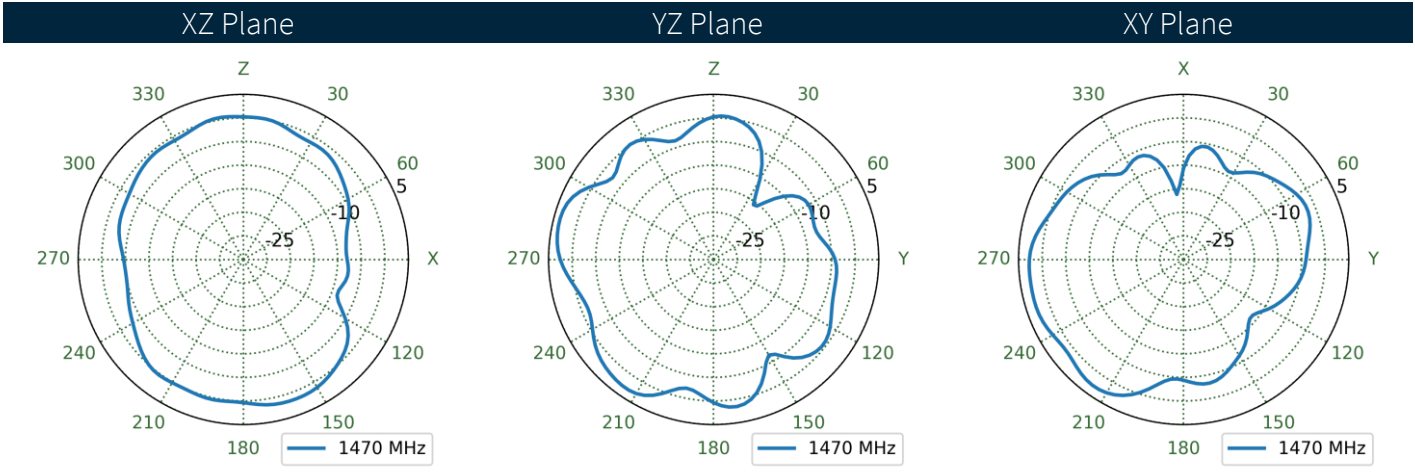
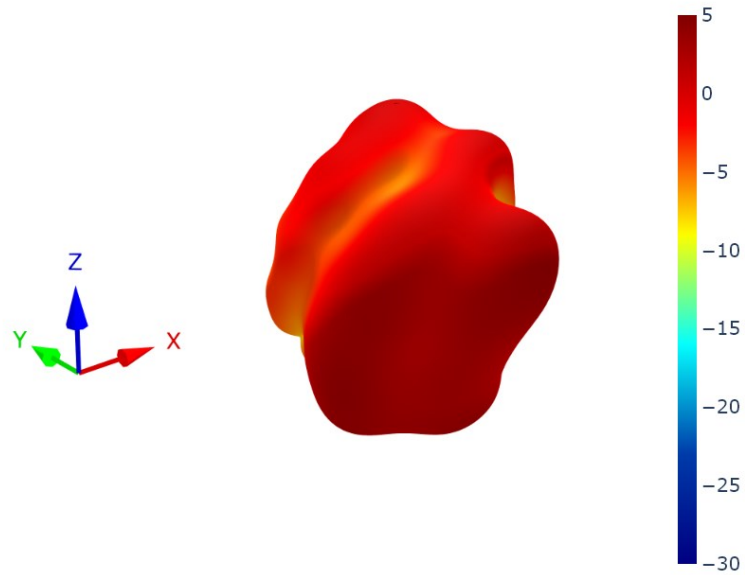

7.19 LTE2 Patterns at 1470 MHz

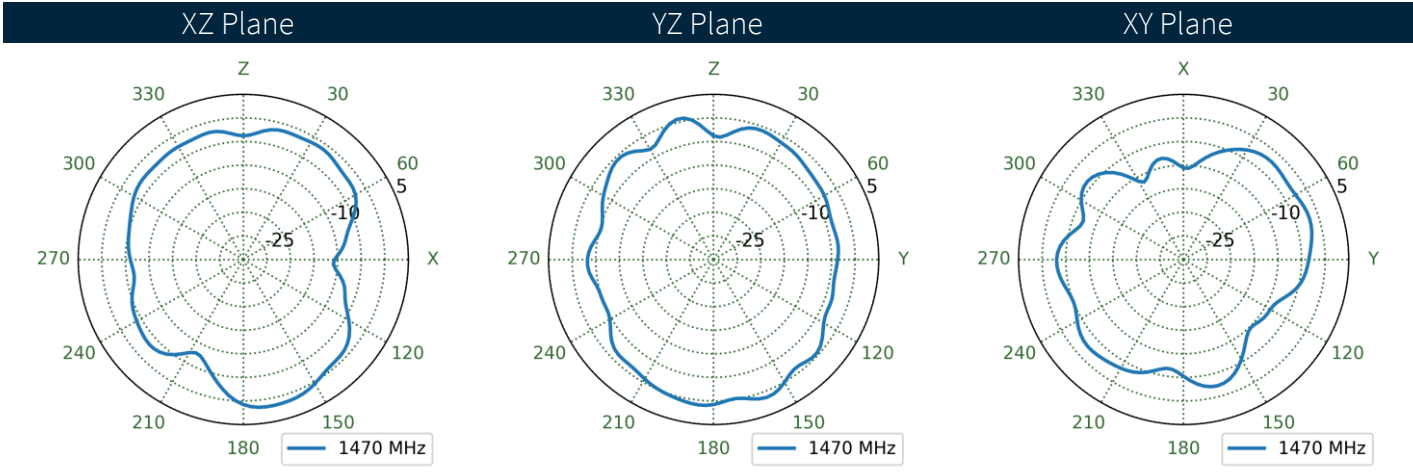
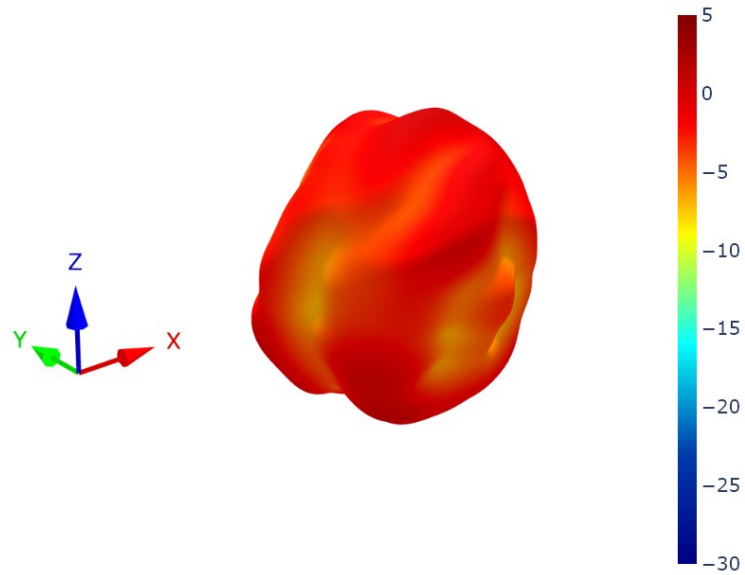

7.20 LTE3 Patterns at 1470 MHz

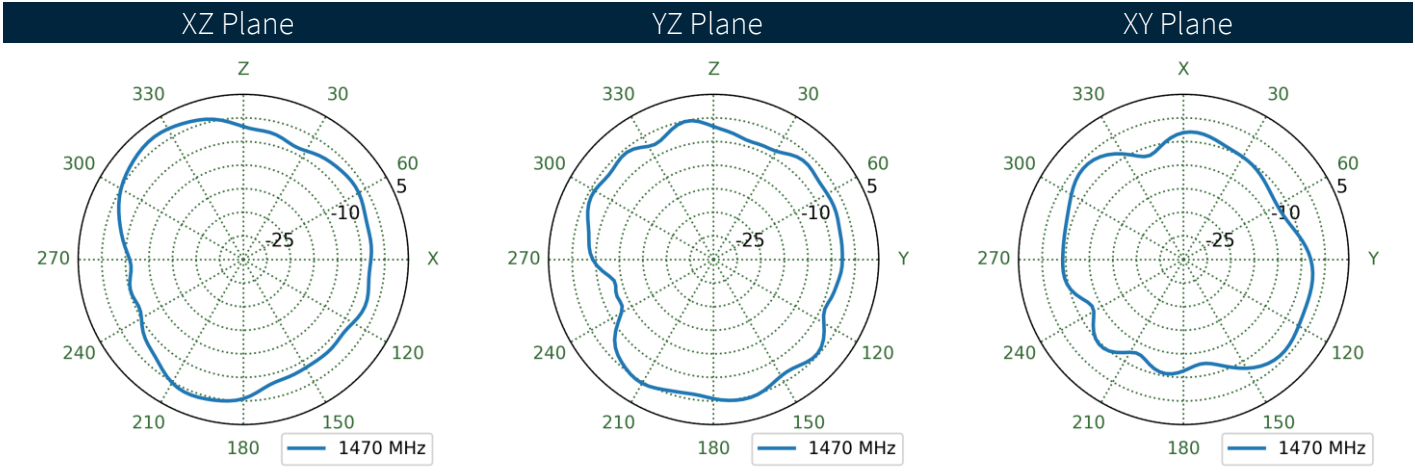
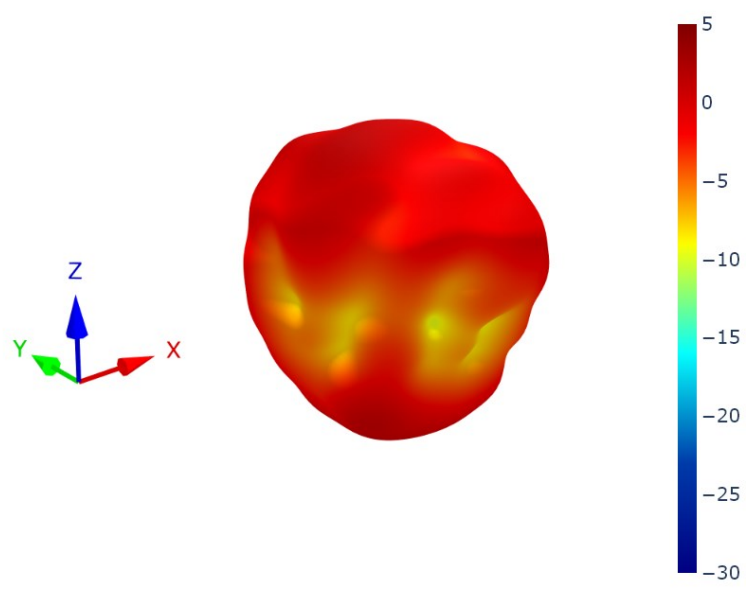

7.21 LTE4 Patterns at 1470 MHz

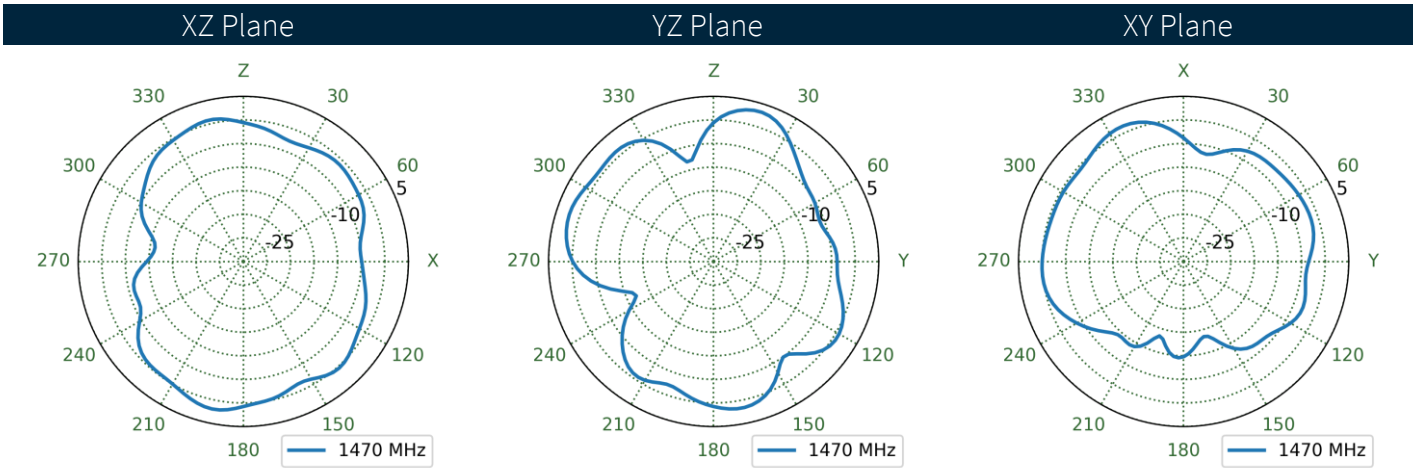
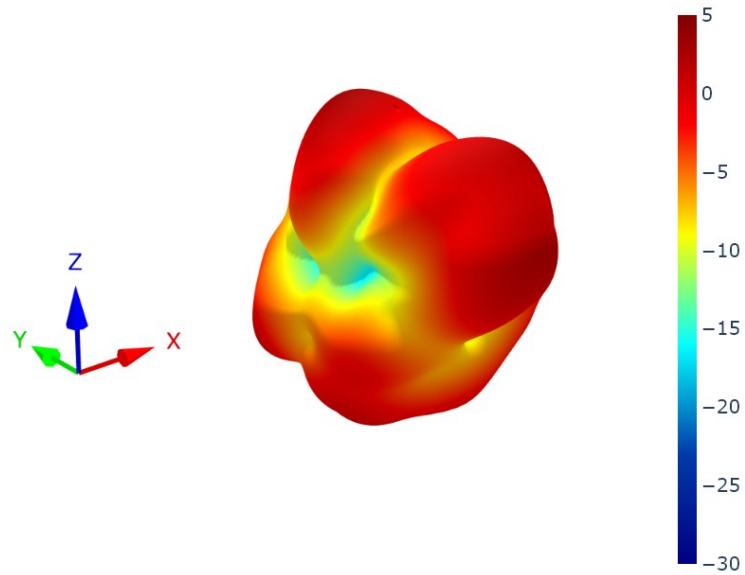

7.22 LTE1 Patterns at 1805 MHz

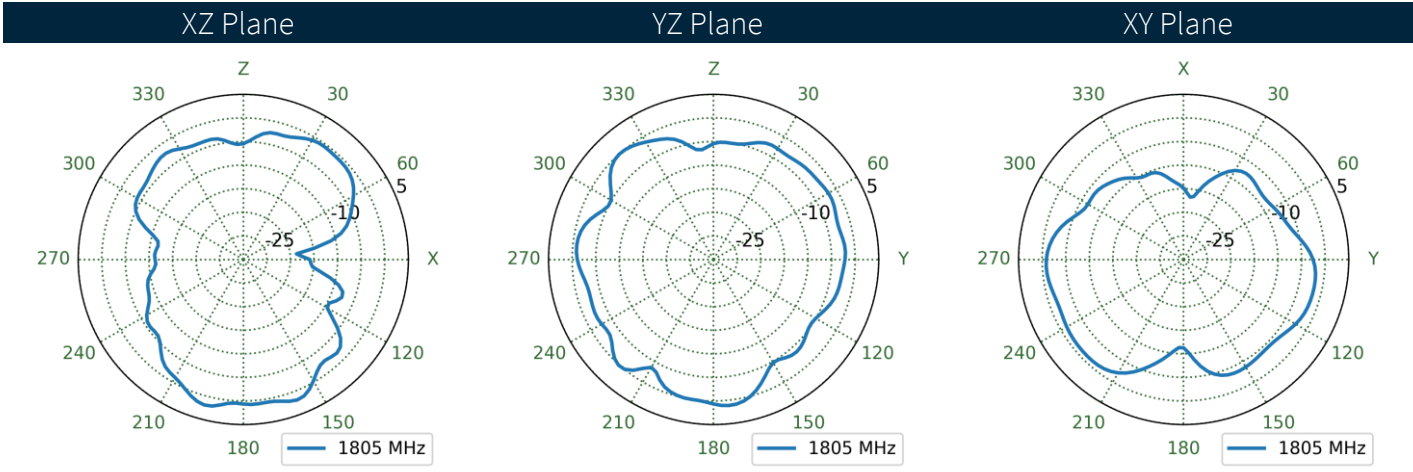
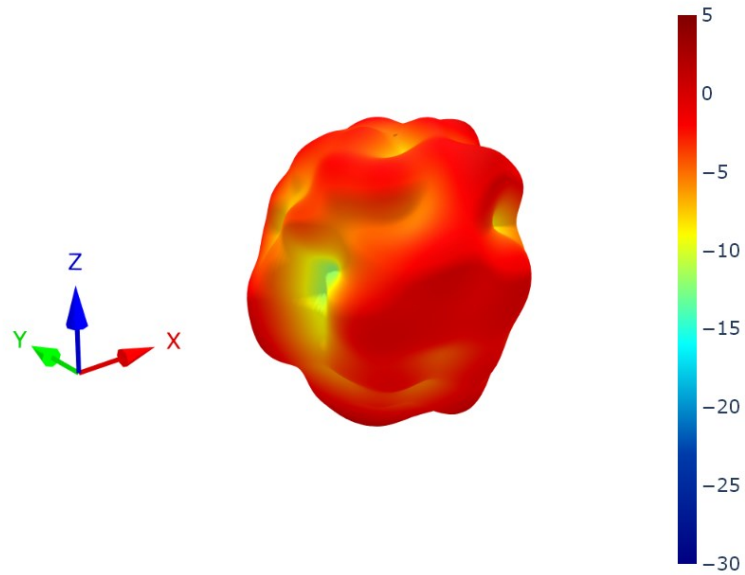

7.23 LTE2 Patterns at 1805 MHz

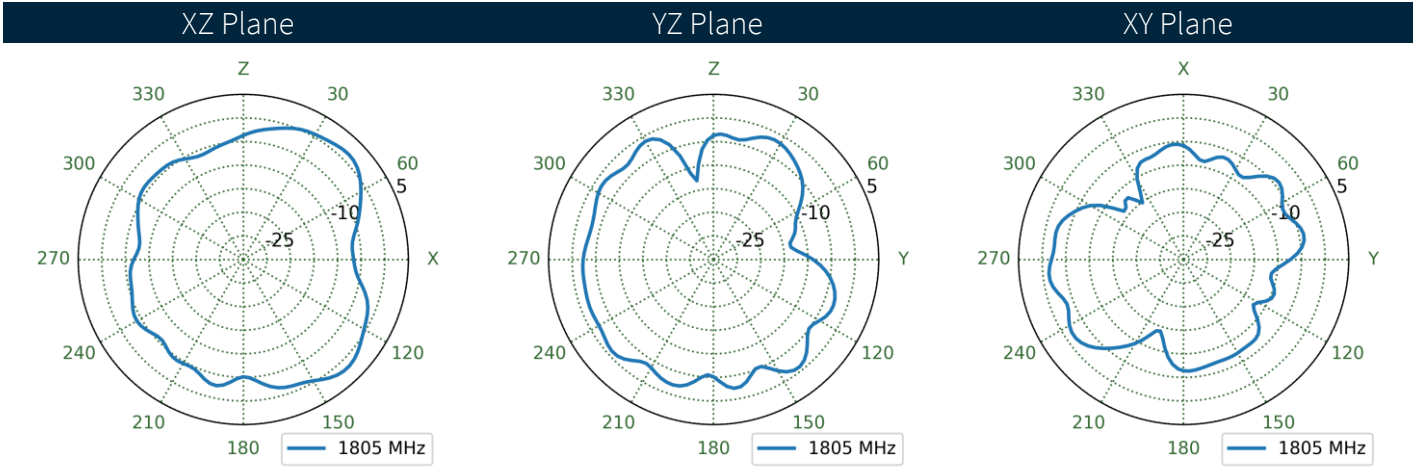
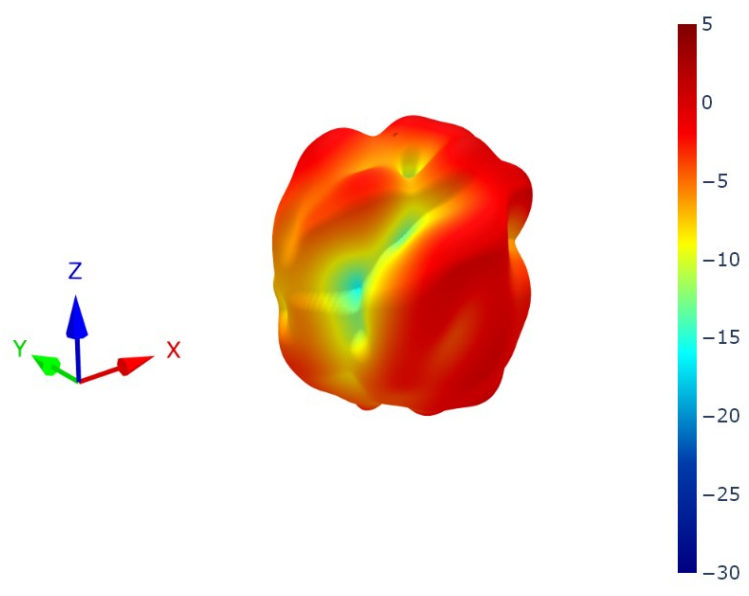

7.24 LTE3 Patterns at 1805 MHz

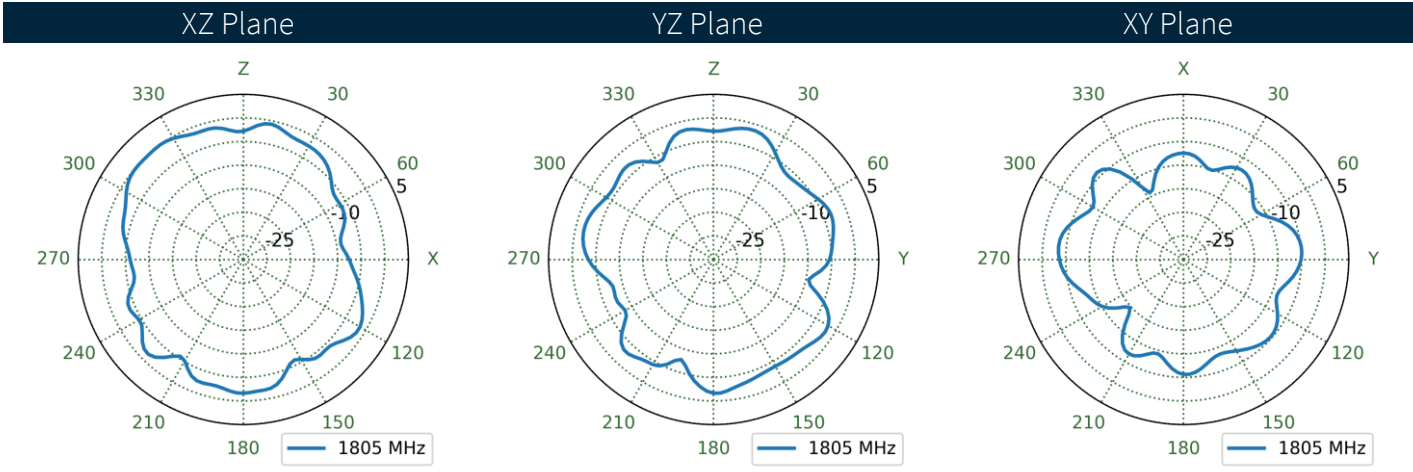
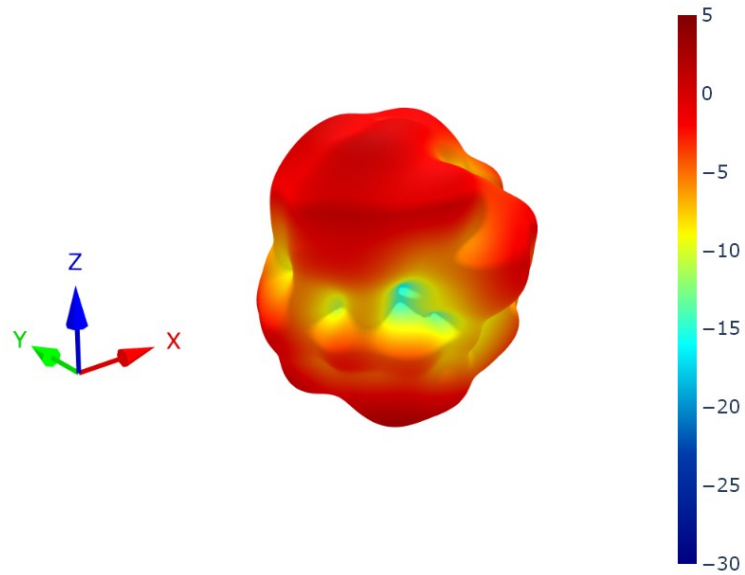

7.25 LTE4 Patterns at 1805 MHz

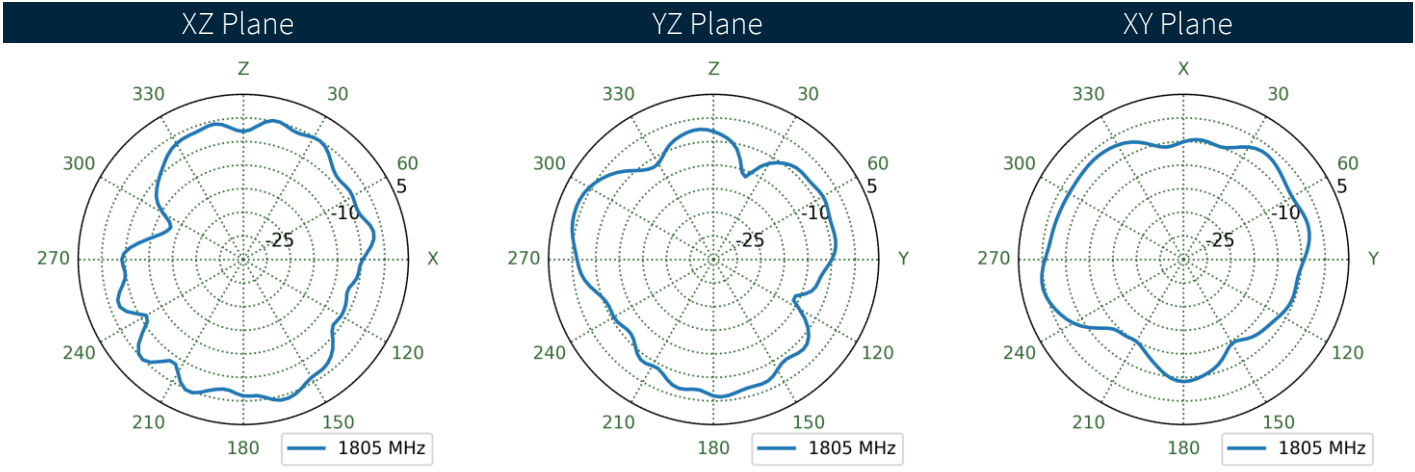
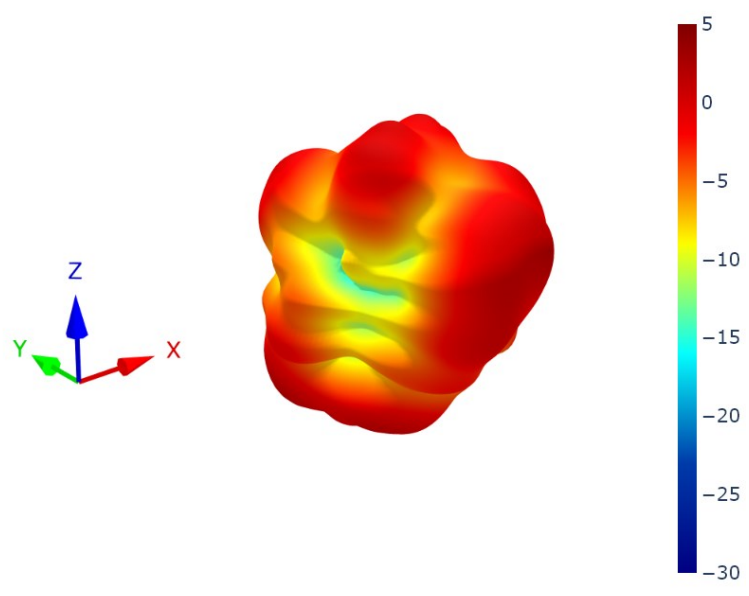

7.26 LTE1 Patterns at 1920 MHz

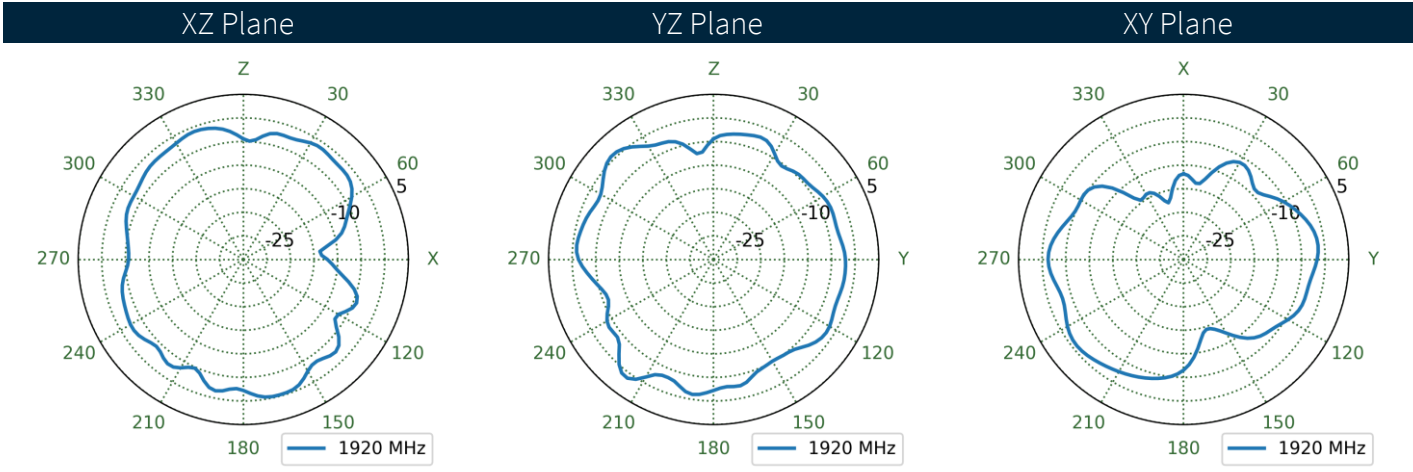
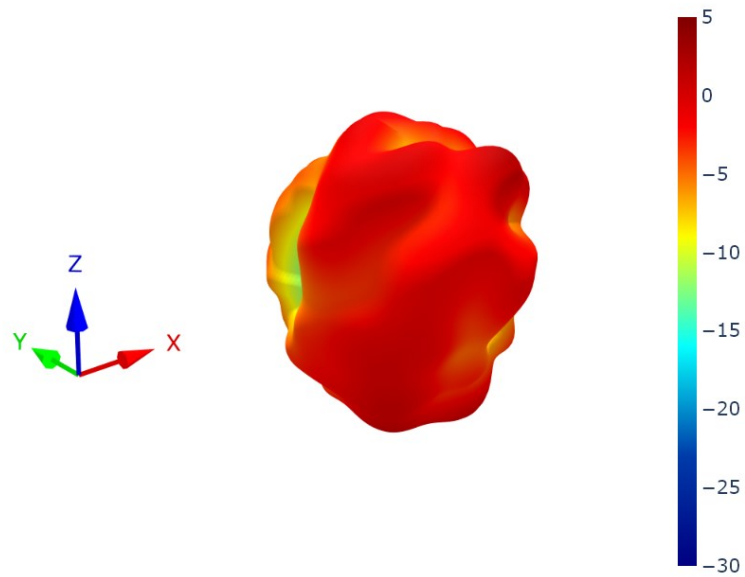

7.27 LTE2 Patterns at 1920 MHz

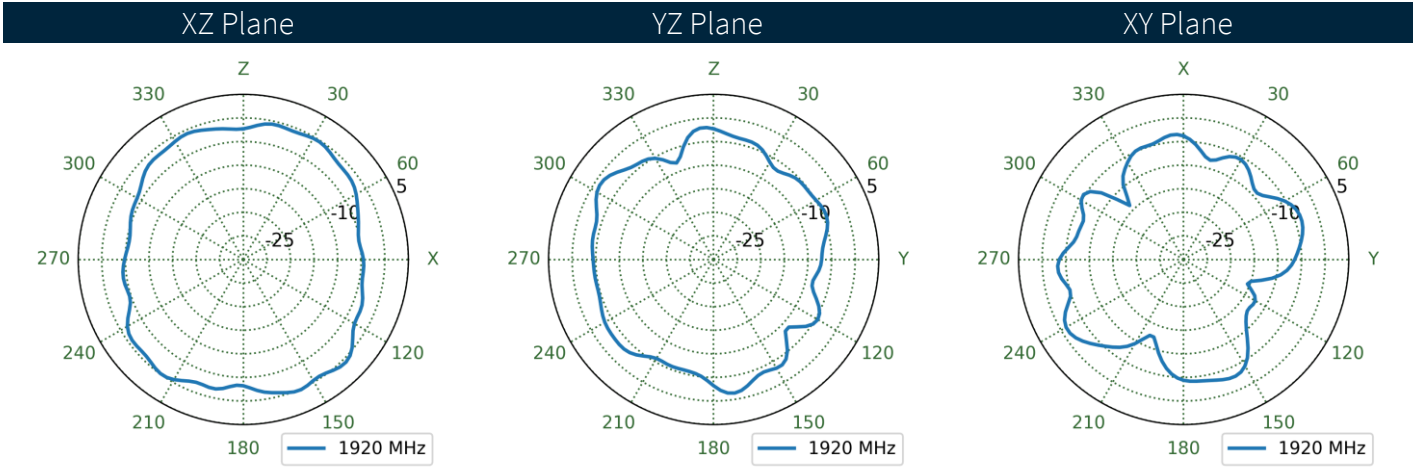
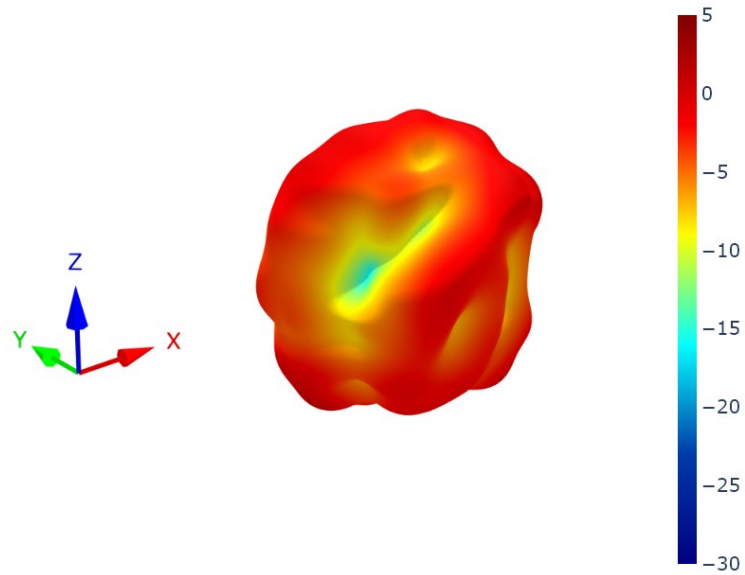

7.28 LTE3 Patterns at 1920 MHz

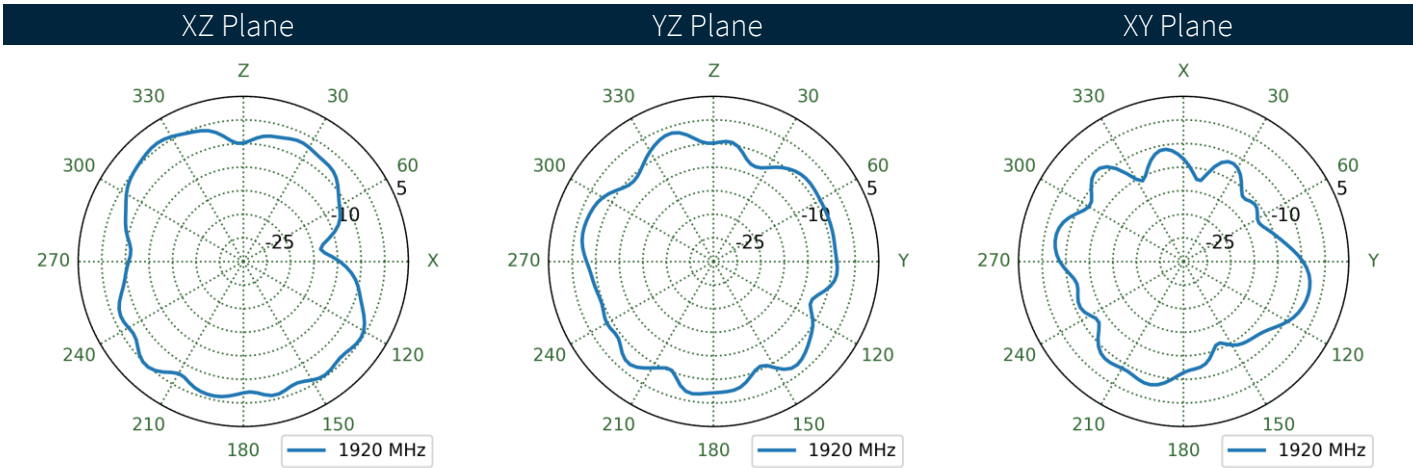
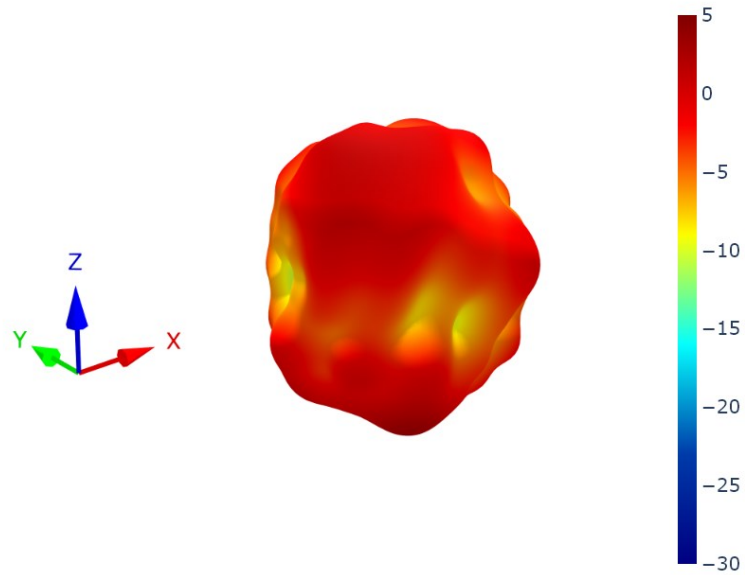

7.29 LTE4 Patterns at 1920 MHz

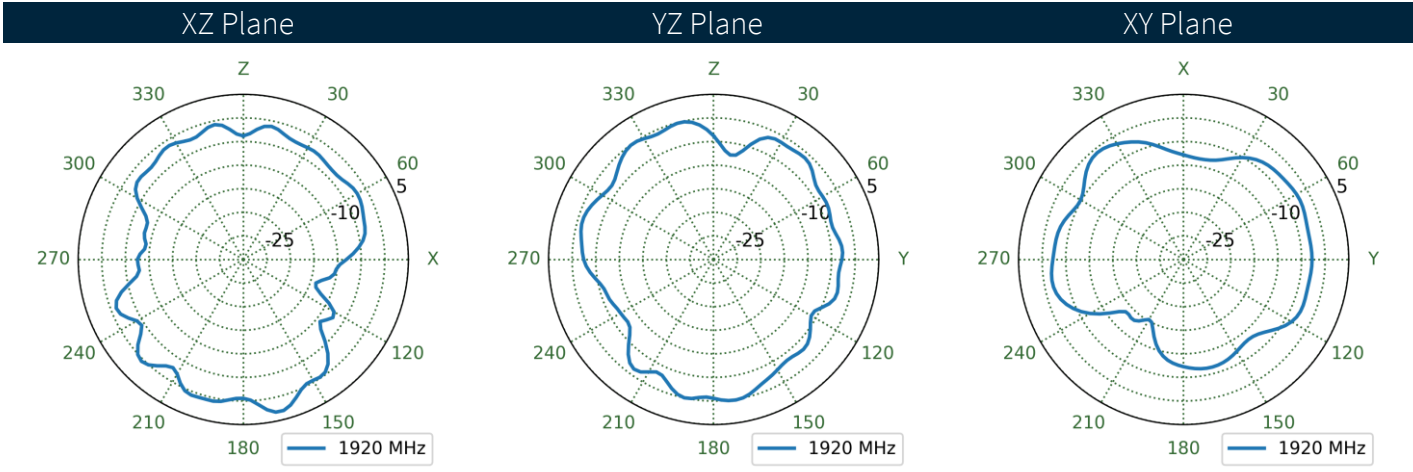
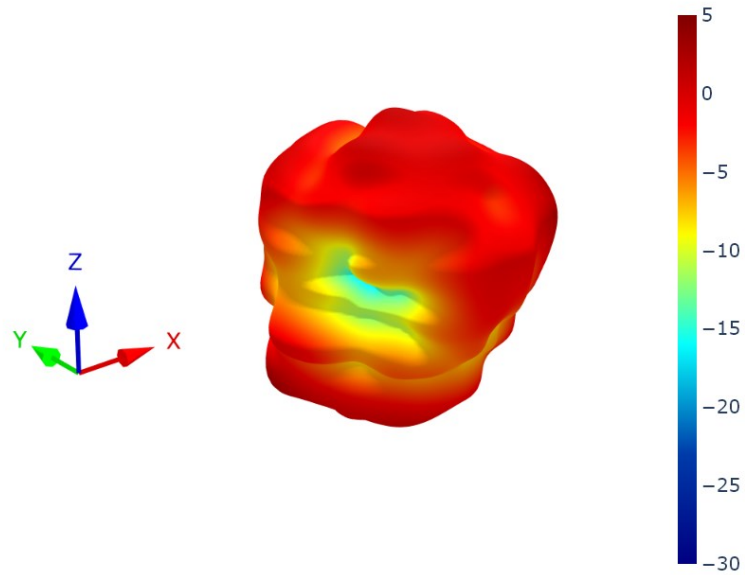

7.30 LTE1 Patterns at 1990 MHz

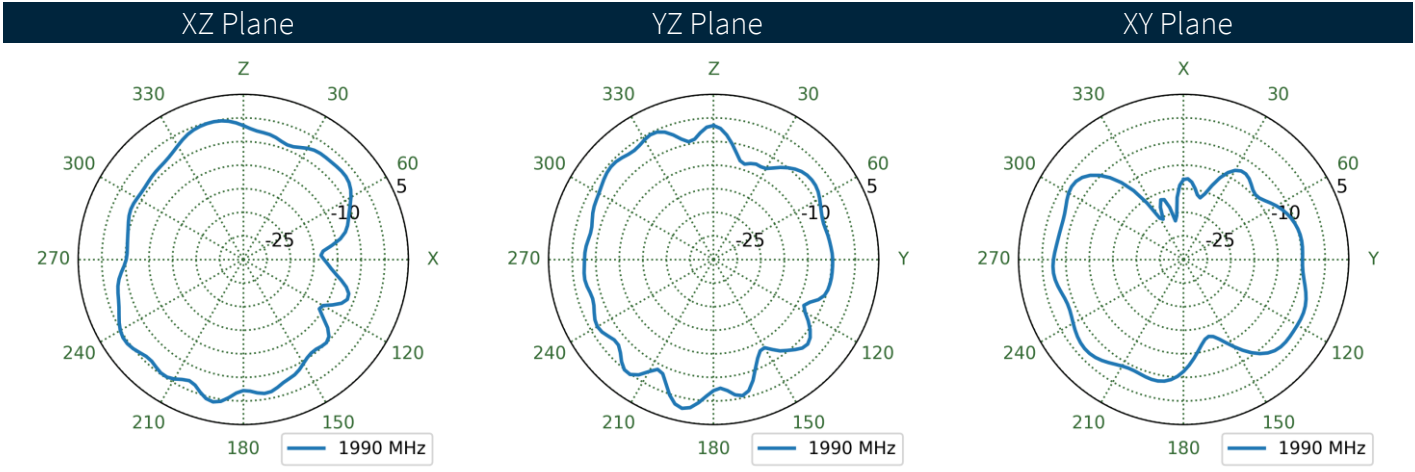
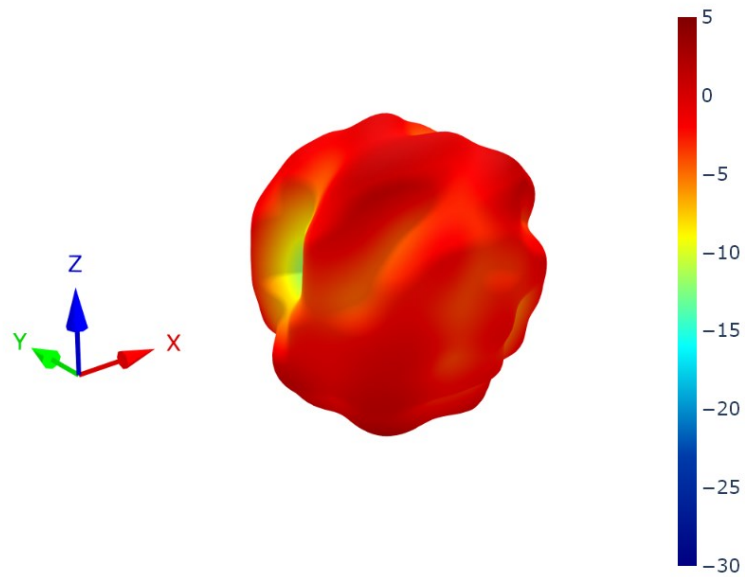

7.31 LTE2 Patterns at 1990 MHz

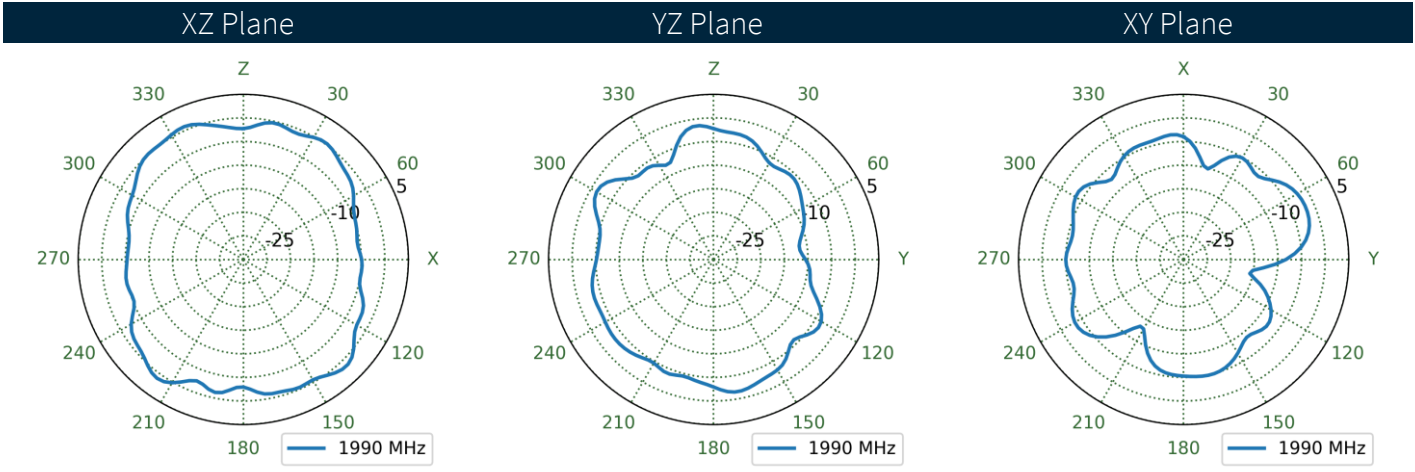
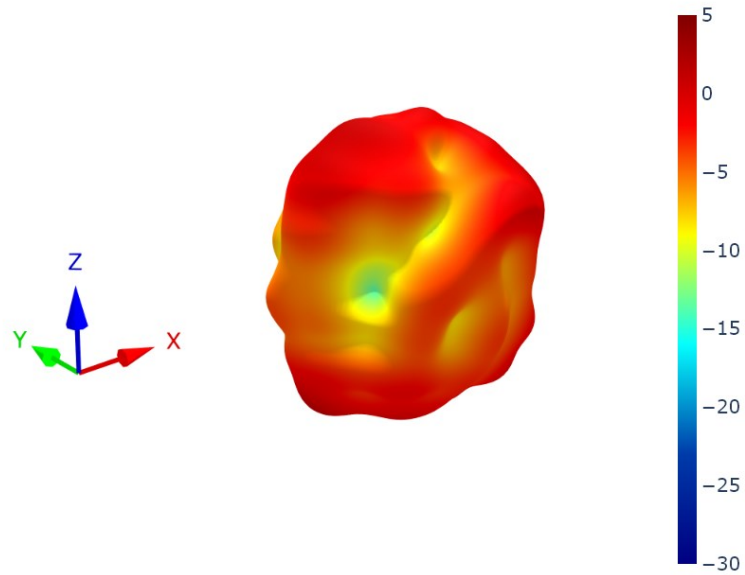

7.32 LTE3 Patterns at 1990 MHz

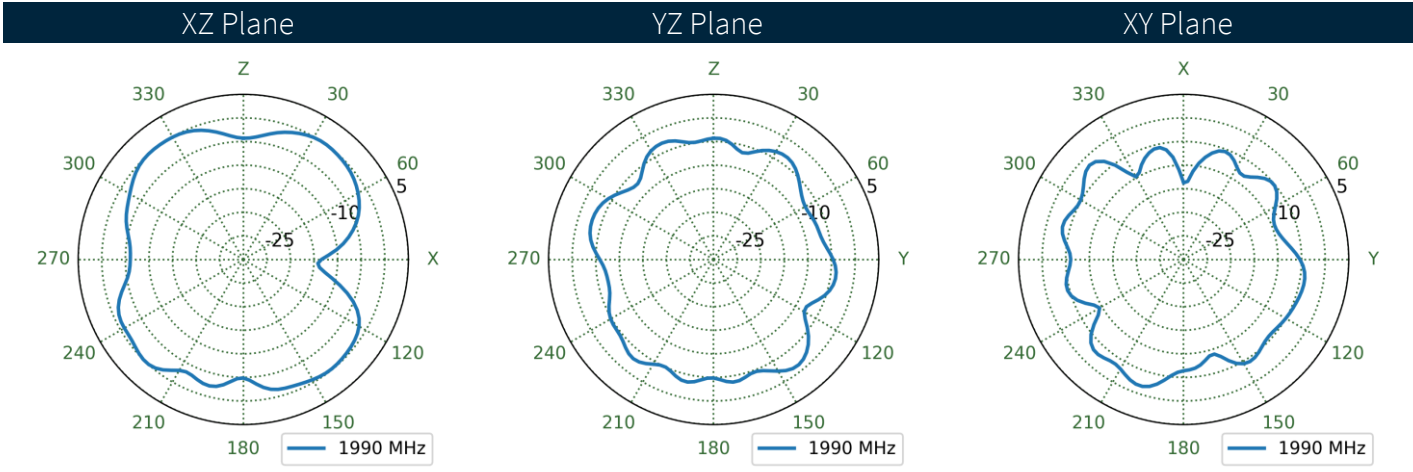
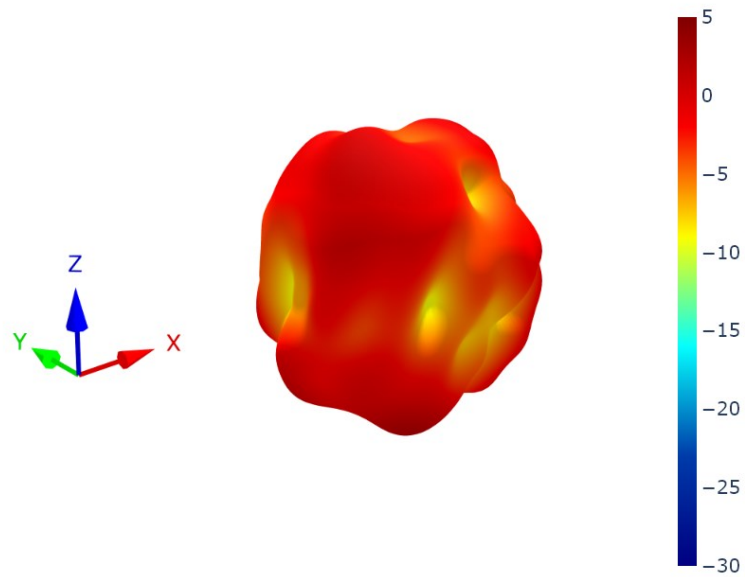

7.33 LTE4 Patterns at 1990 MHz

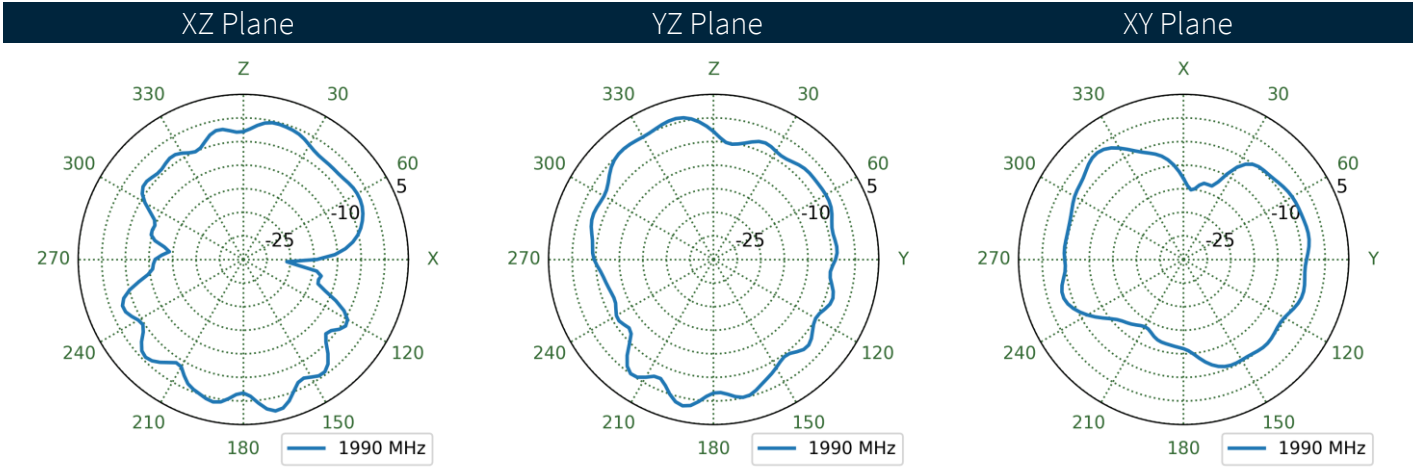
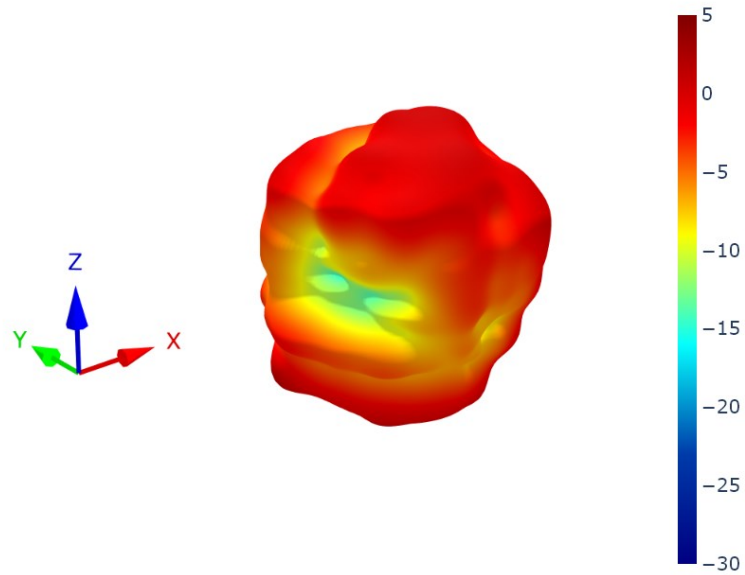

7.34 LTE1 Patterns at 2360 MHz

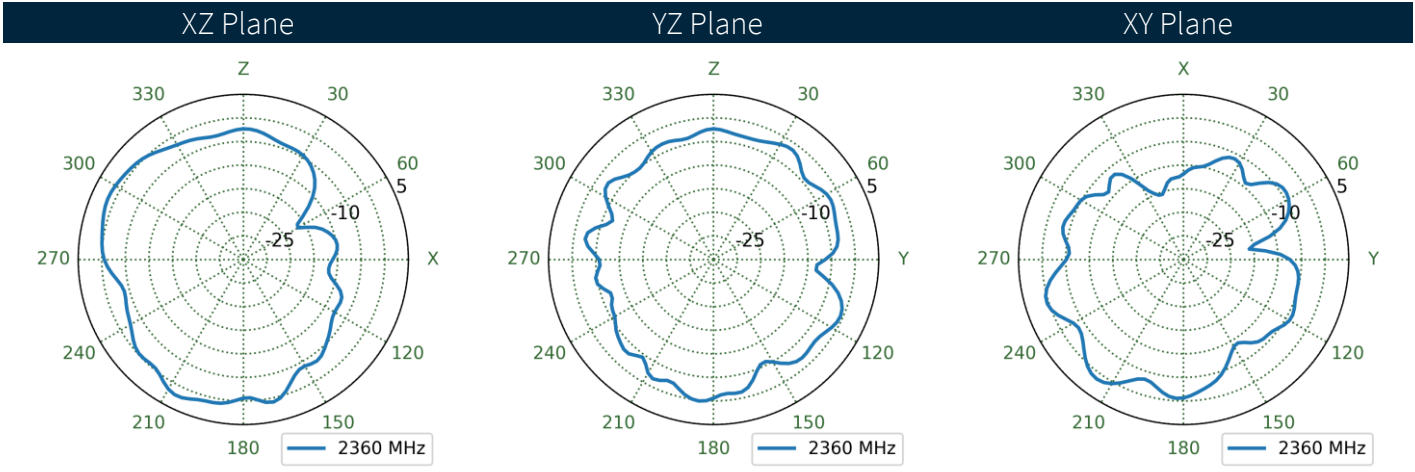
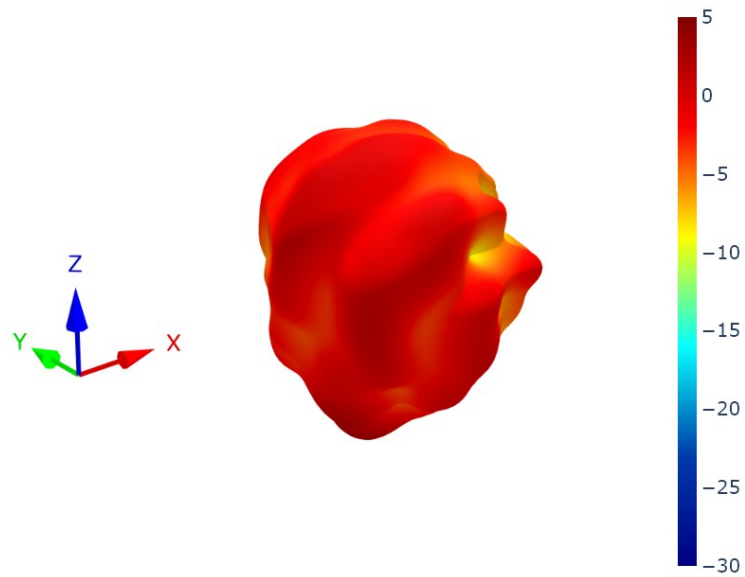

7.35 LTE2 Patterns at 2360 MHz

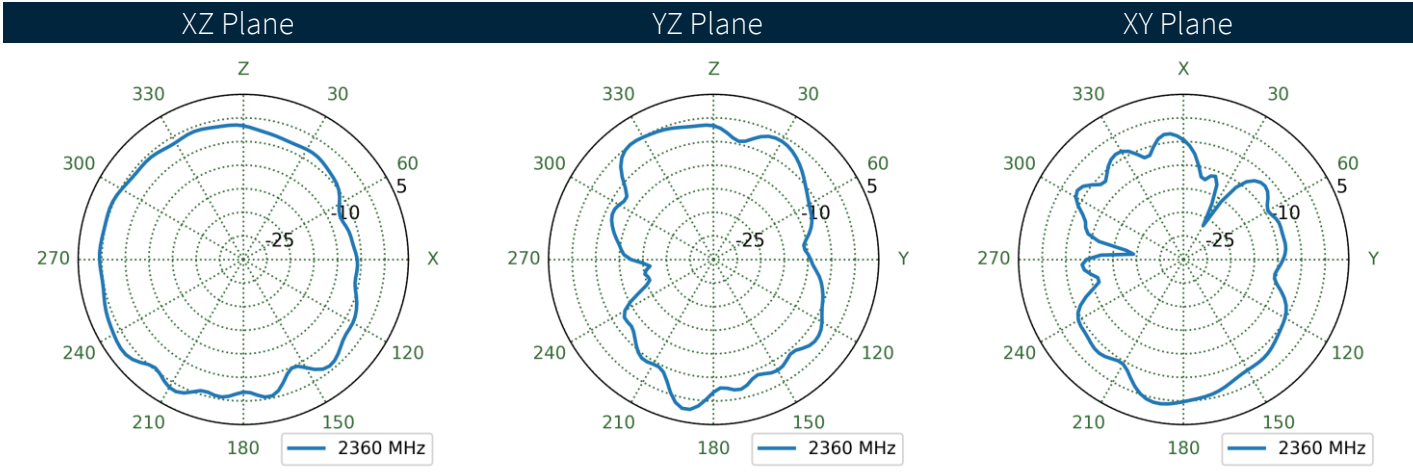
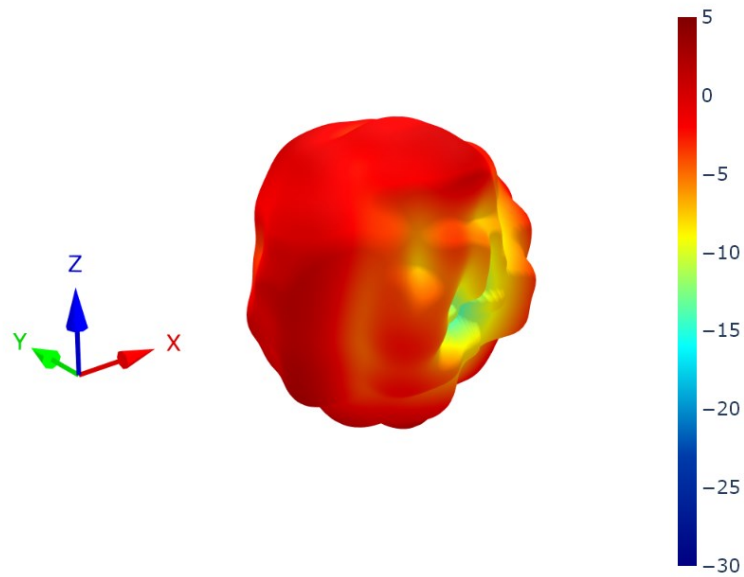

7.36 LTE3 Patterns at 2360 MHz

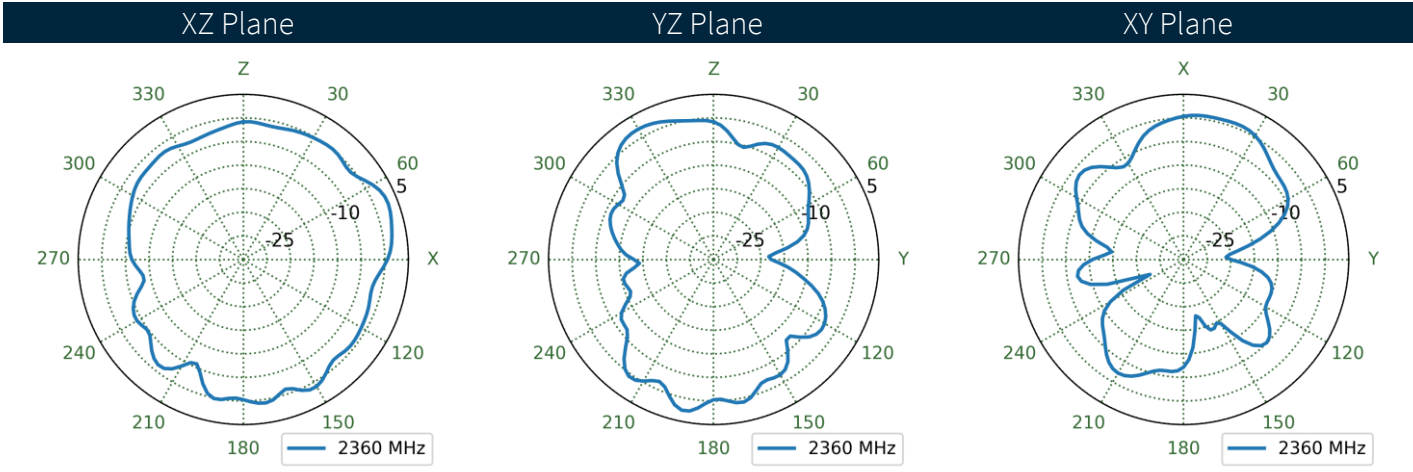
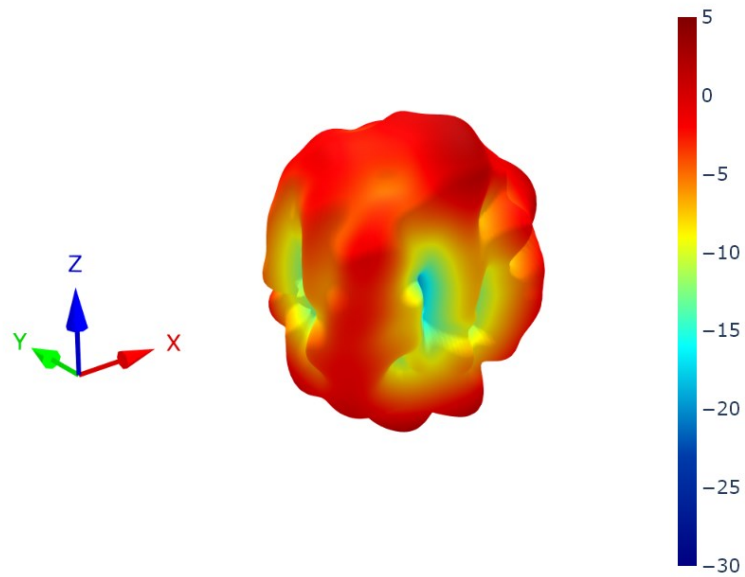

7.37 LTE4 Patterns at 2360 MHz

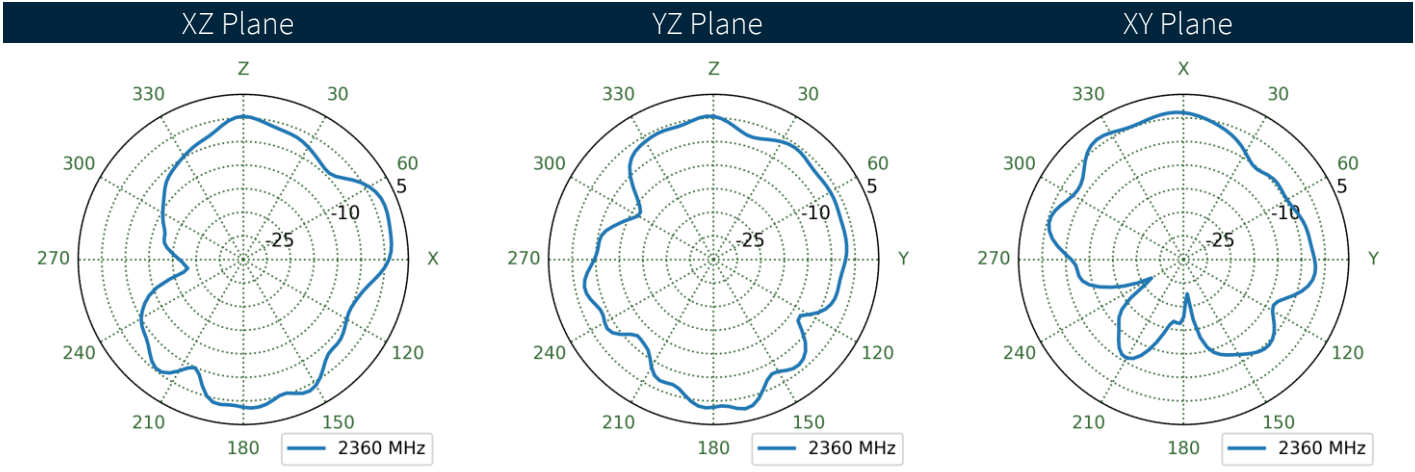
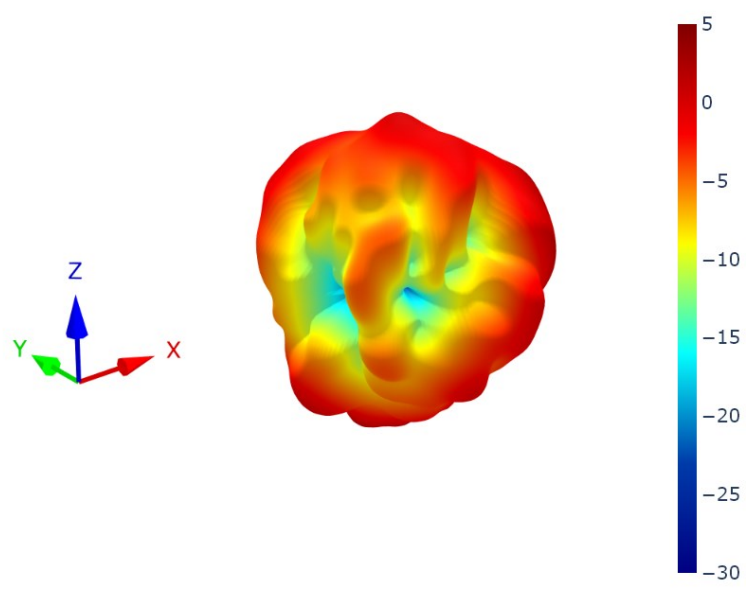

7.38 LTE1 Patterns at 2595 MHz

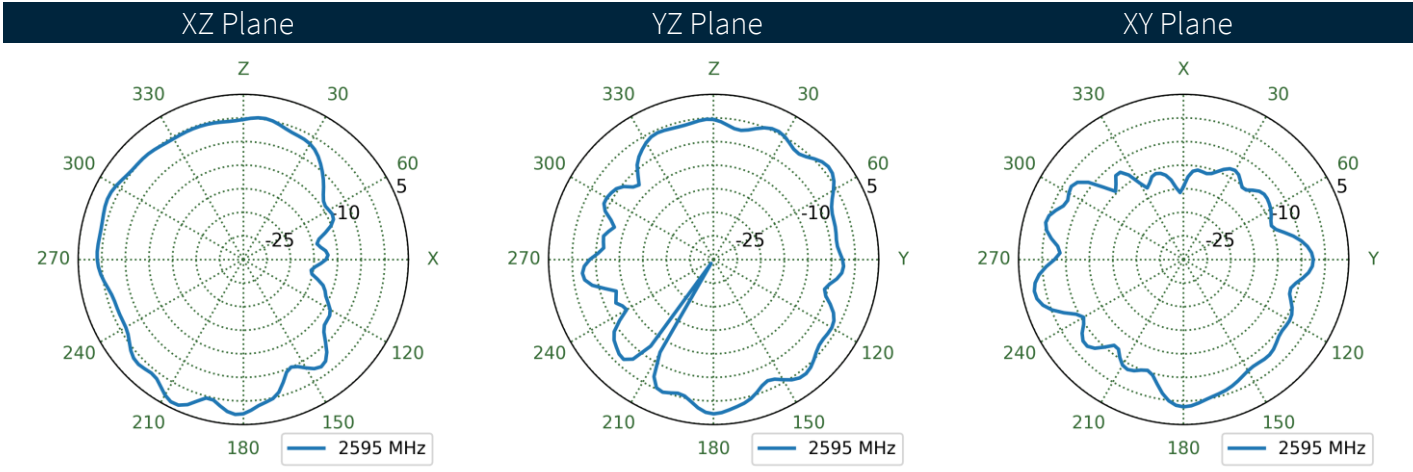
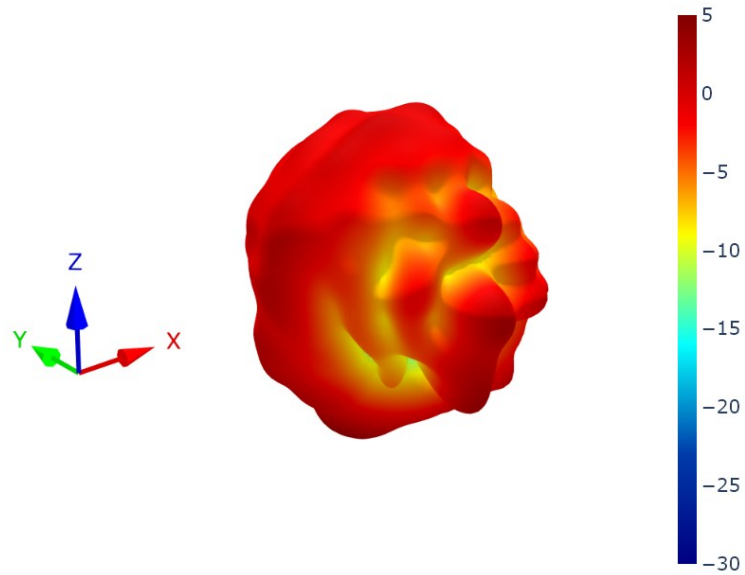

7.39 LTE2 Patterns at 2595 MHz

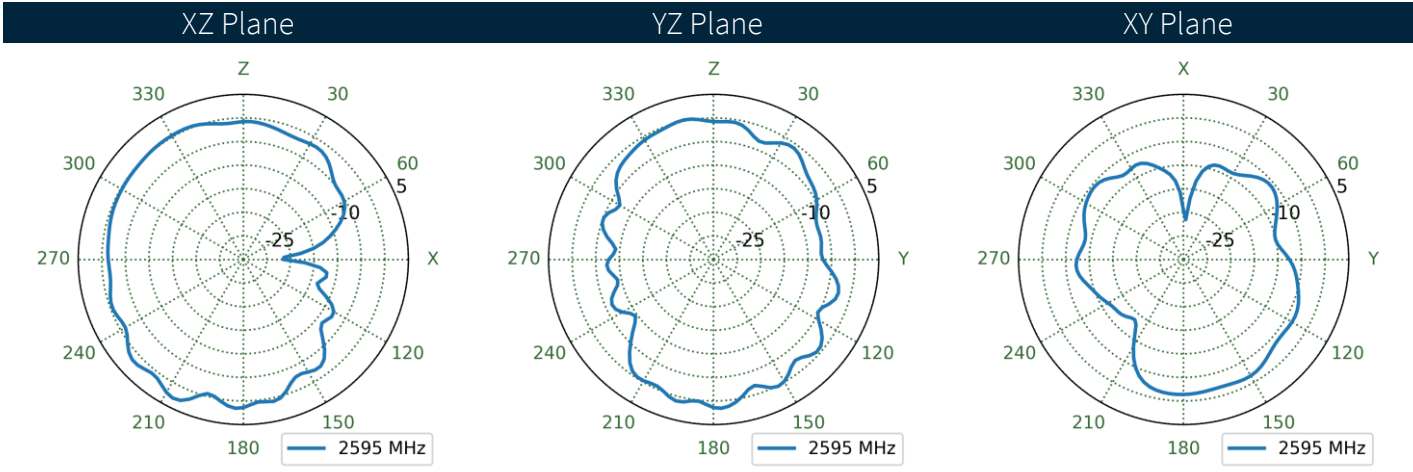
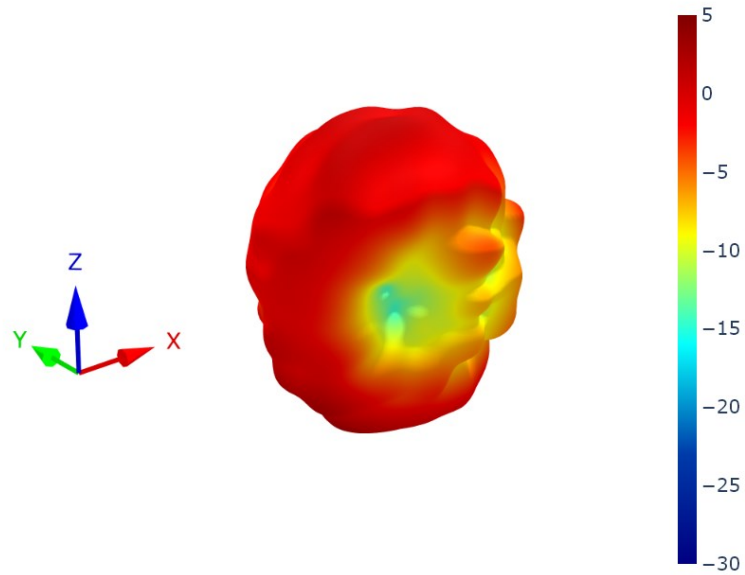

7.40 LTE3 Patterns at 2595 MHz

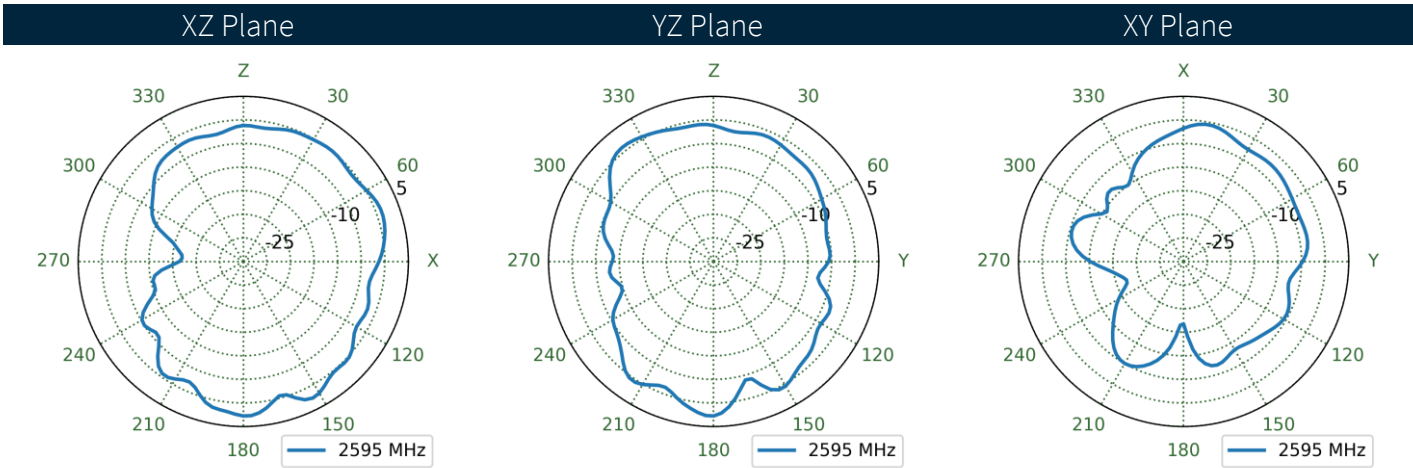
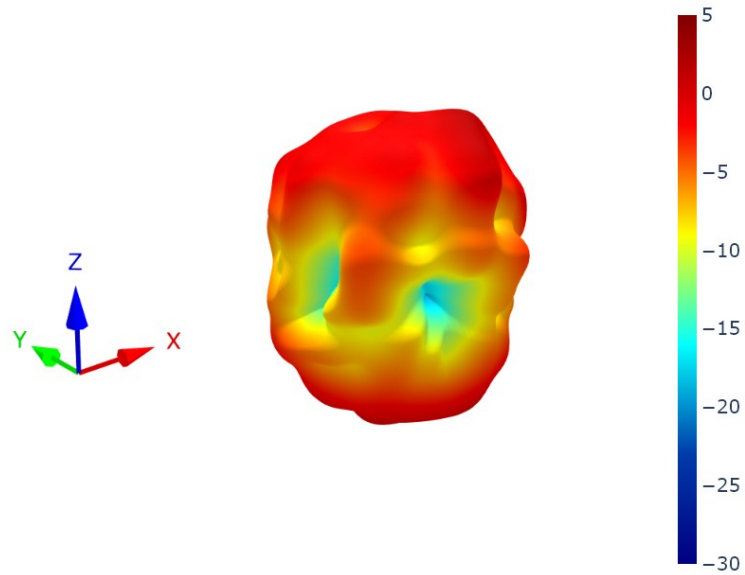

7.41 LTE4 Patterns at 2595 MHz

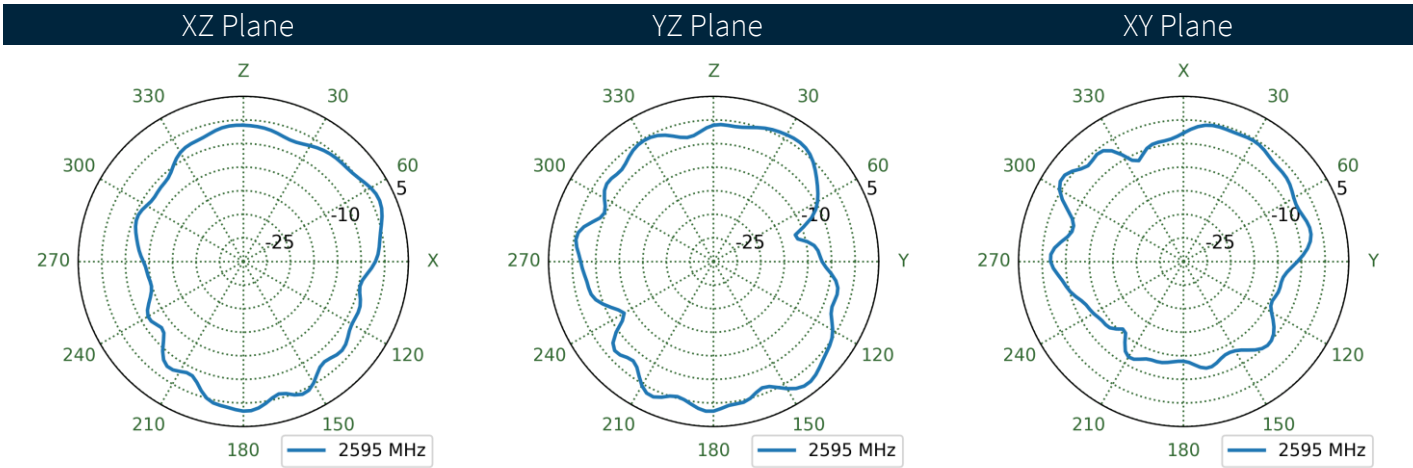
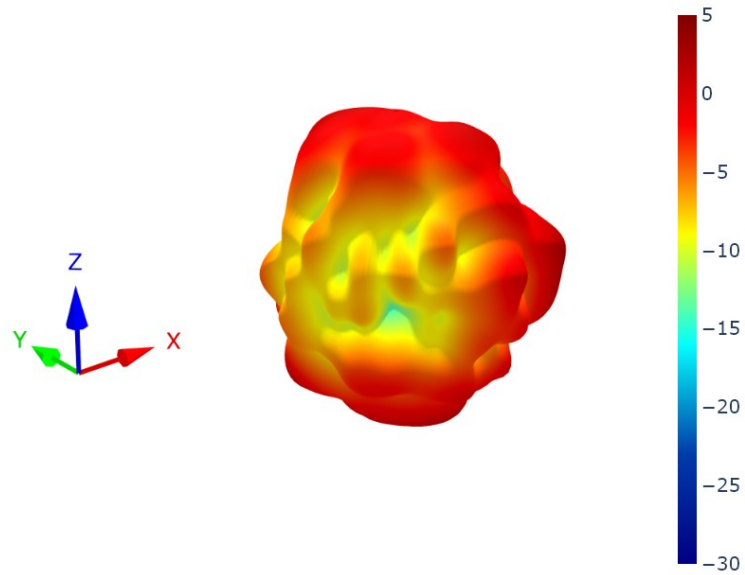

7.42 LTE1 Patterns at 3550 MHz

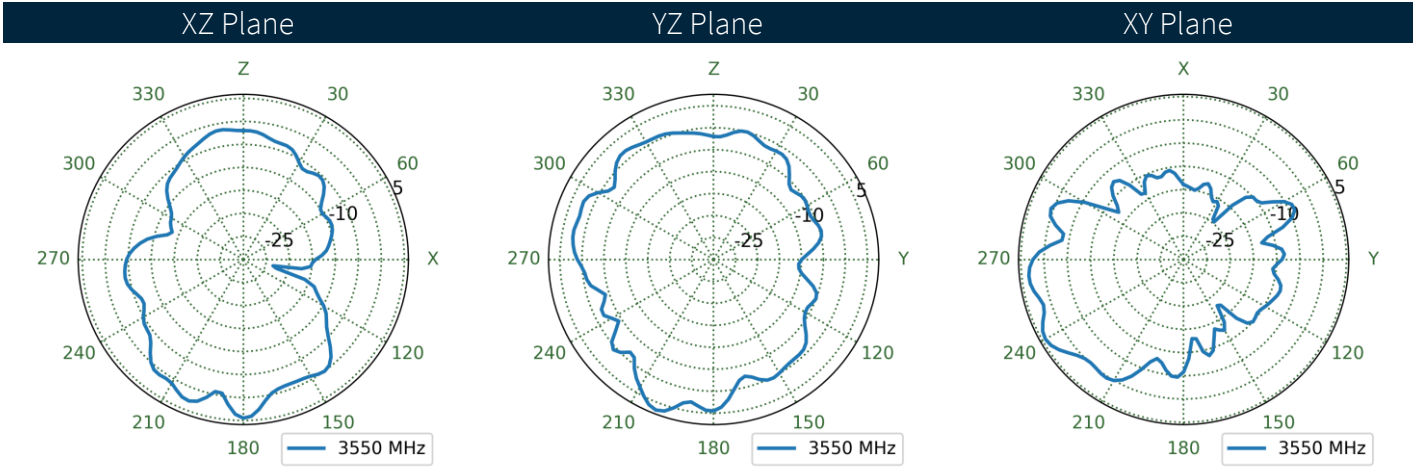
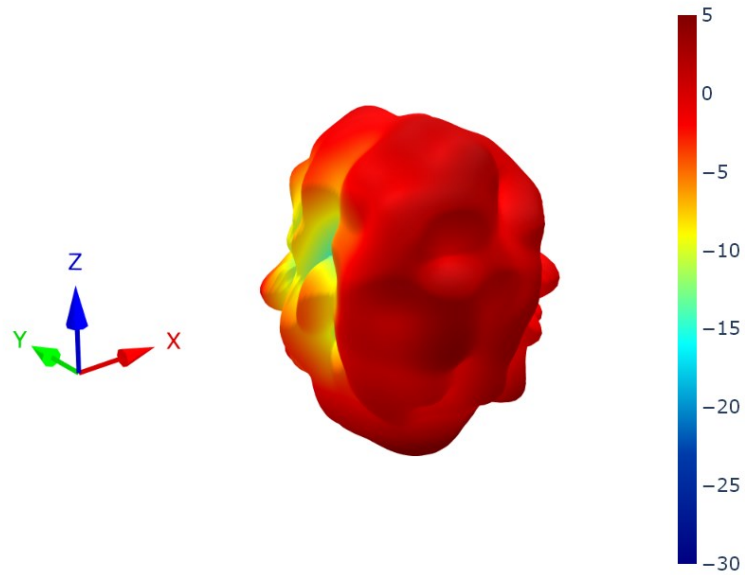

7.43 LTE2 Patterns at 3550 MHz

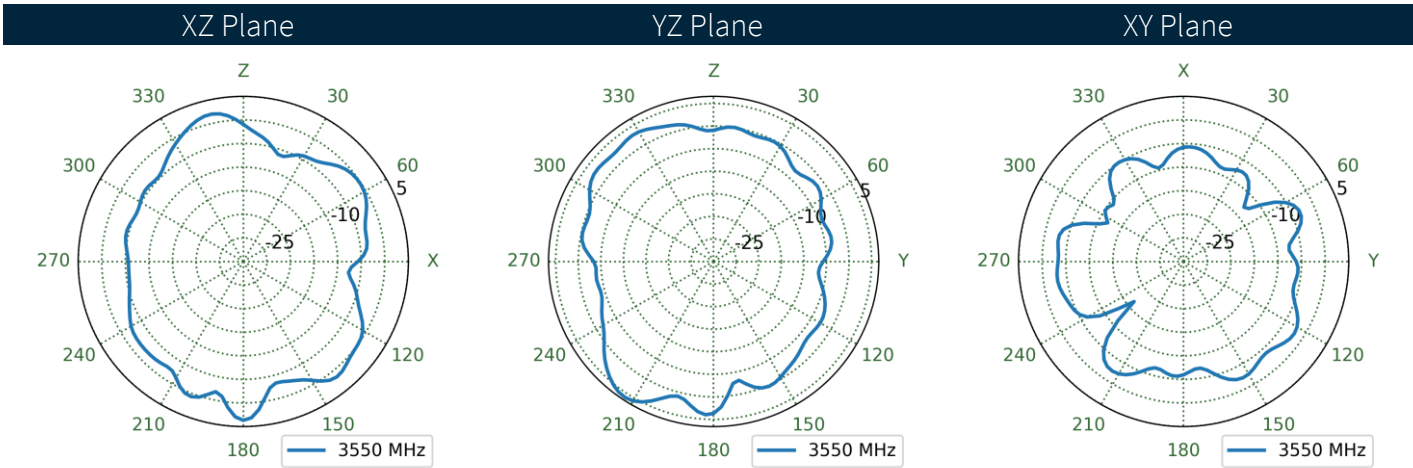
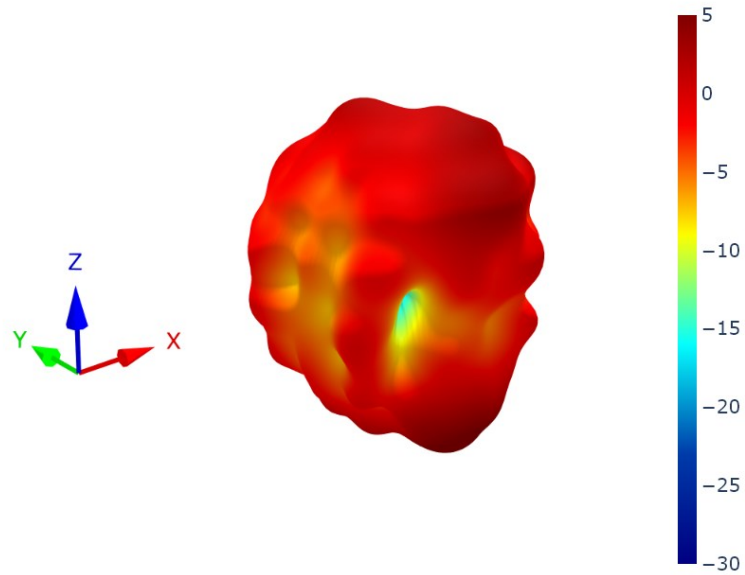

7.44 LTE3 Patterns at 3550 MHz

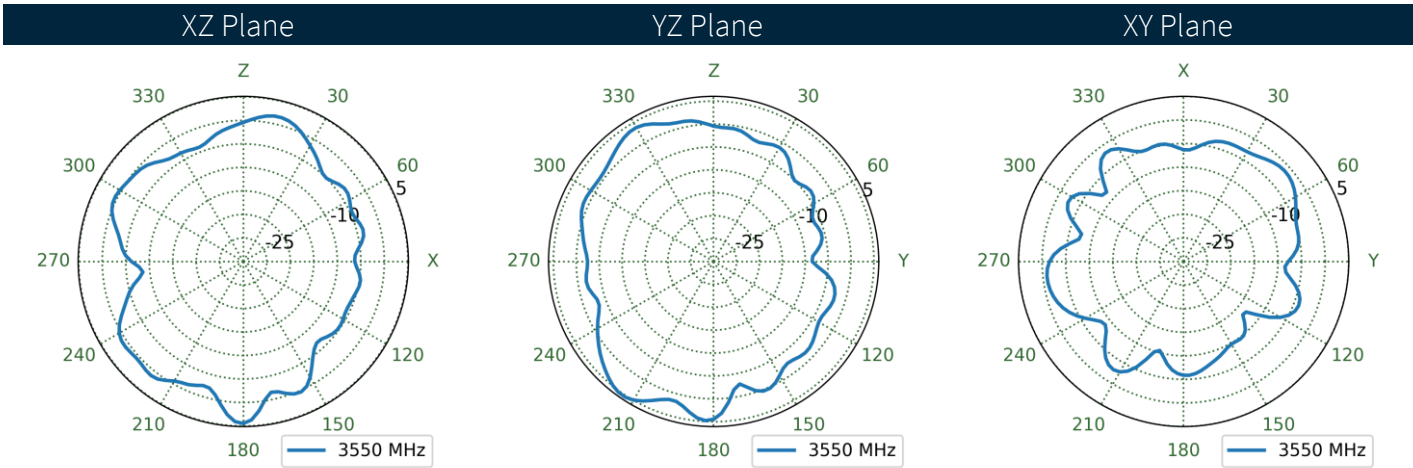
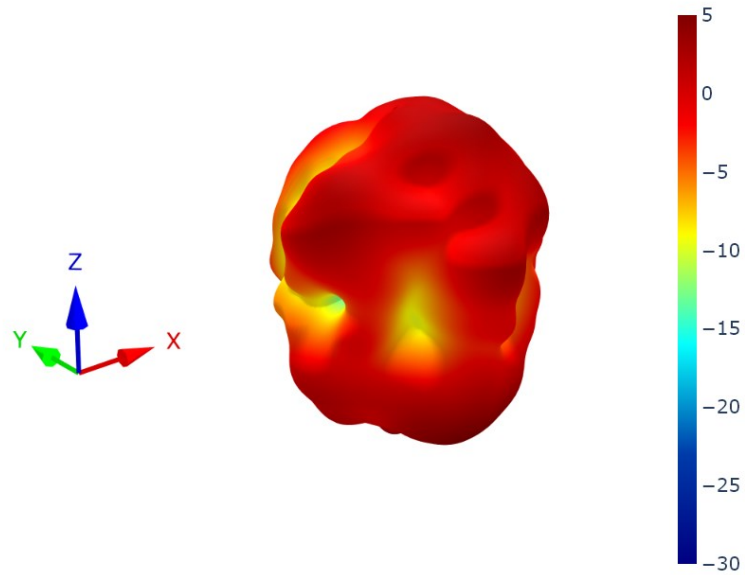

7.45 LTE4 Patterns at 3550 MHz

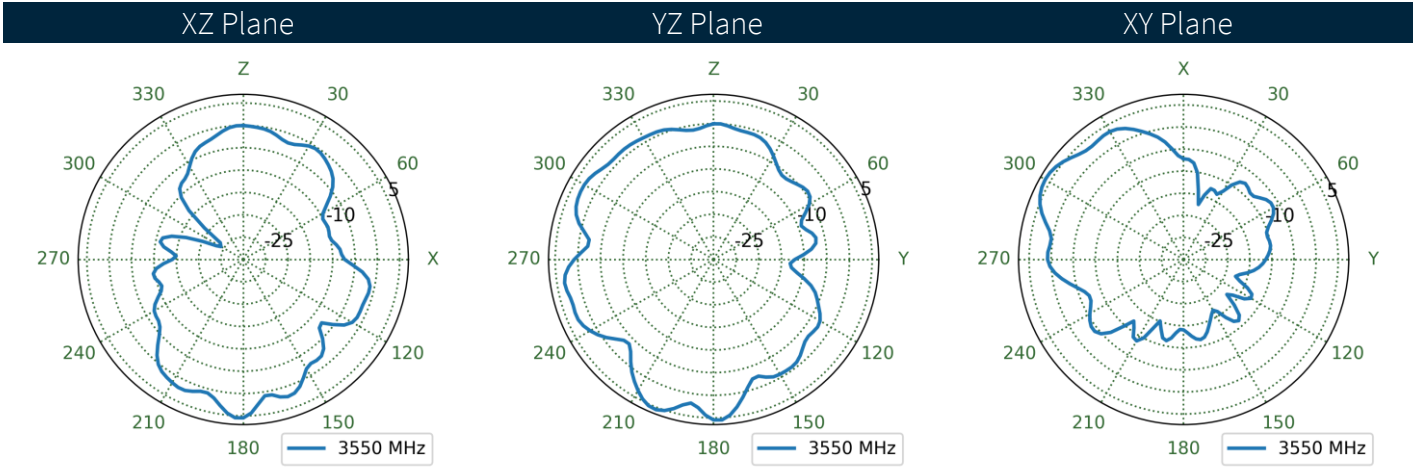
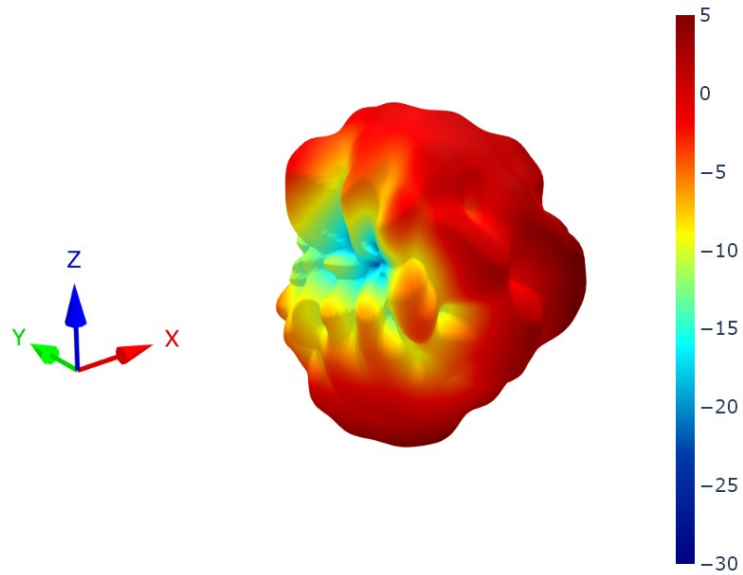

7.46 LTE1 Patterns at 4600 MHz

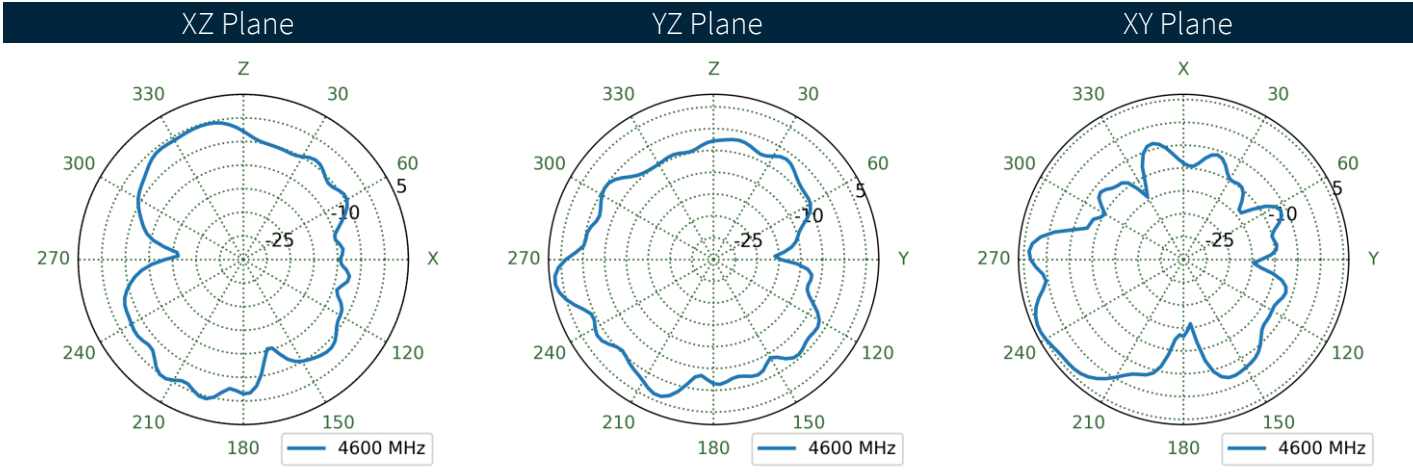
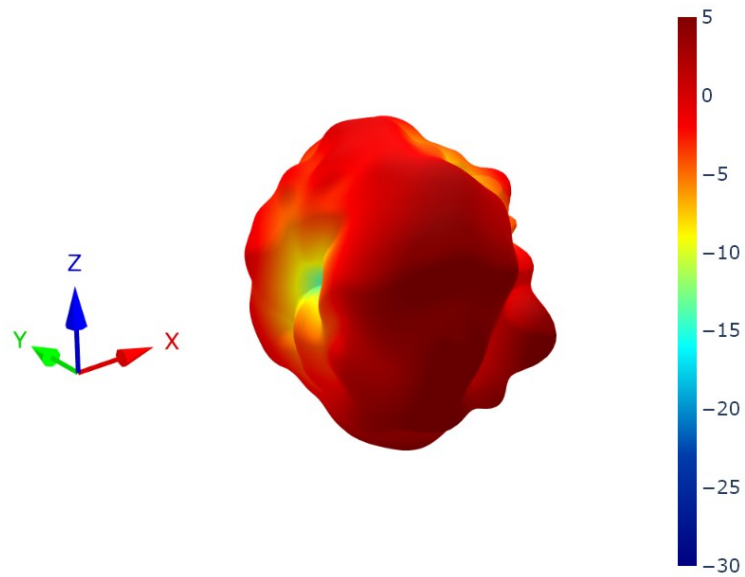

7.47 LTE2 Patterns at 4600 MHz

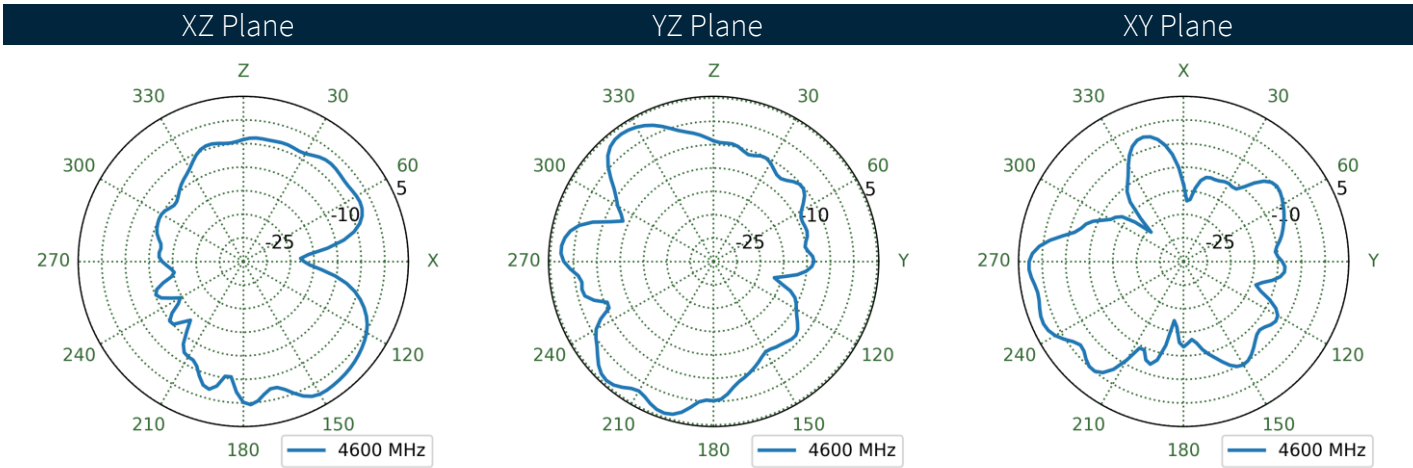
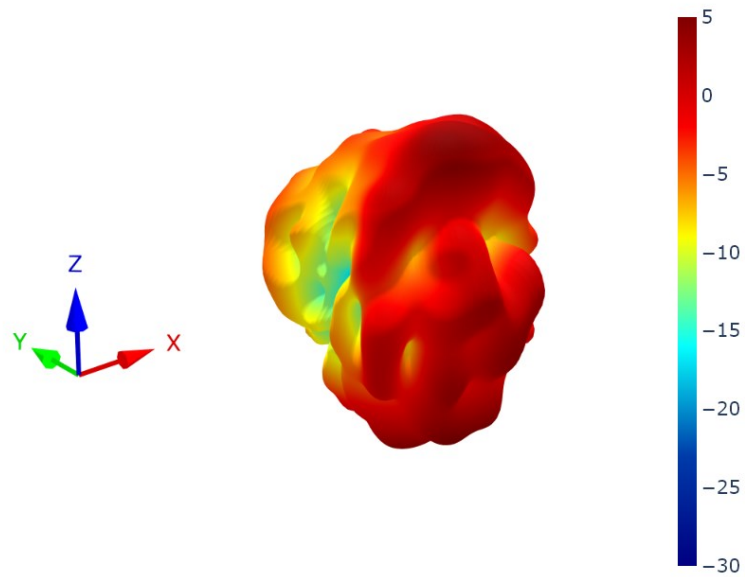

7.48 LTE3 Patterns at 4600 MHz

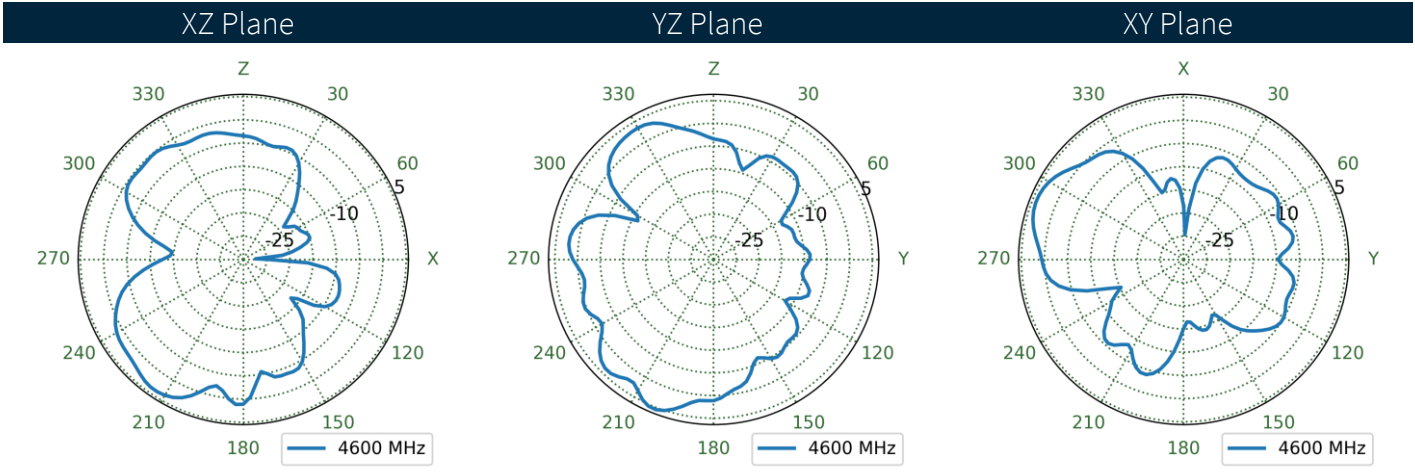
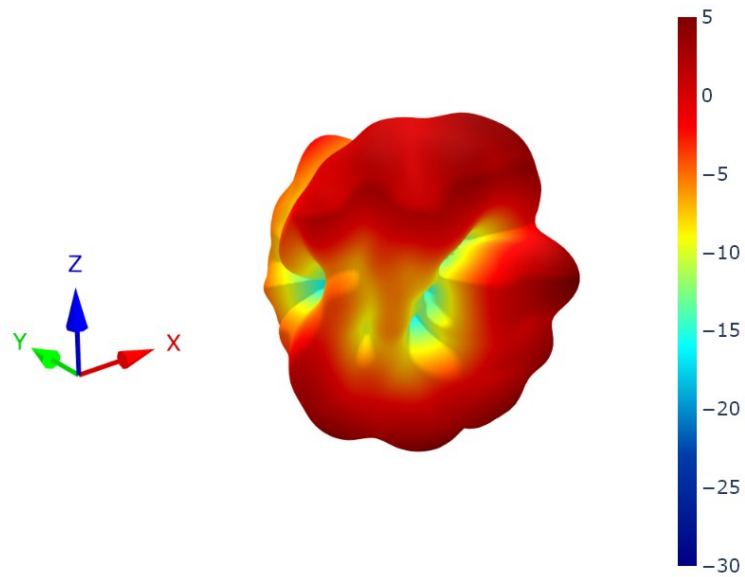

7.49 LTE4 Patterns at 4600 MHz

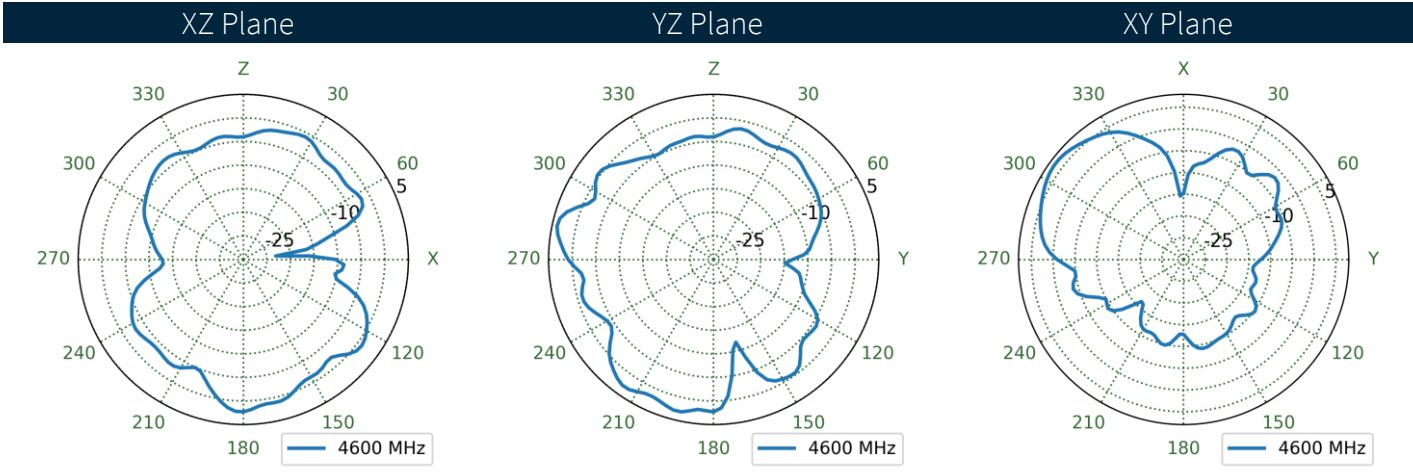
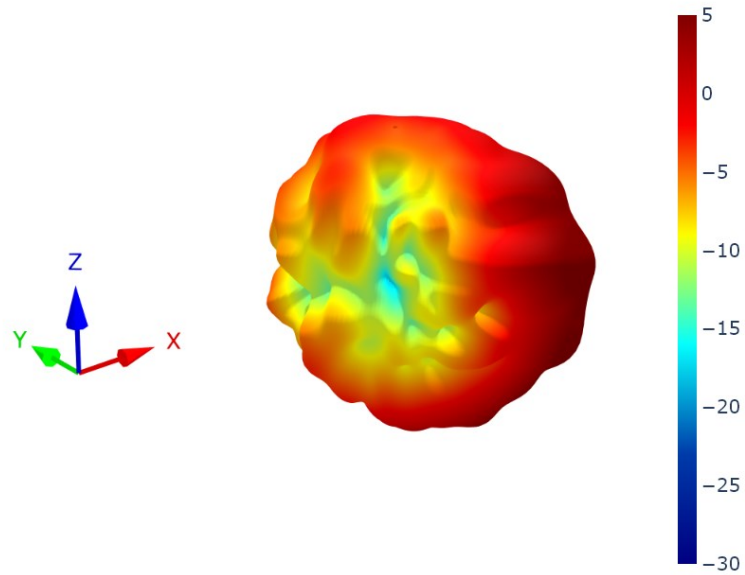

7.50 LTE1 Patterns at 4800 MHz

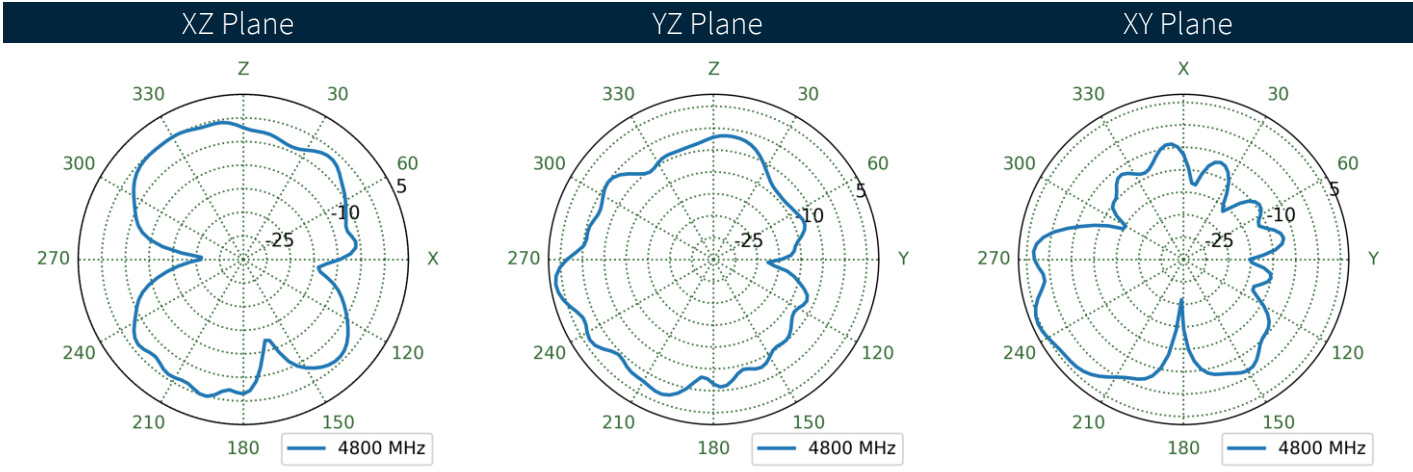
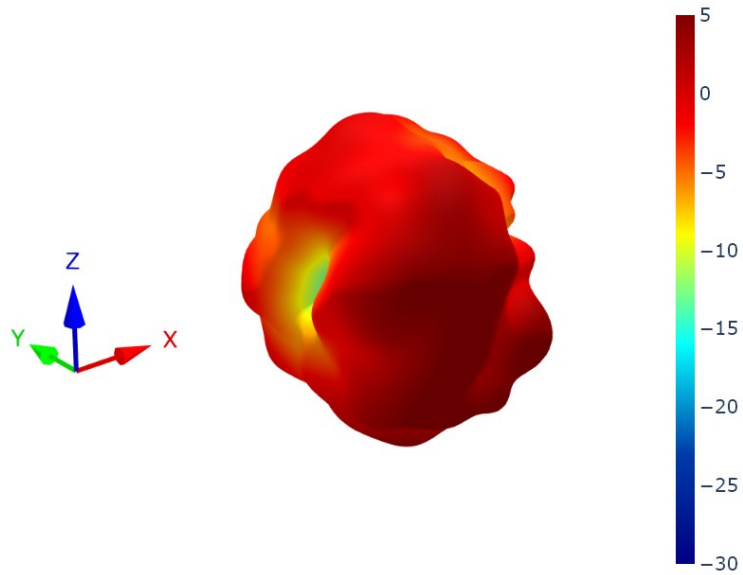

7.51 LTE2 Patterns at 4800 MHz

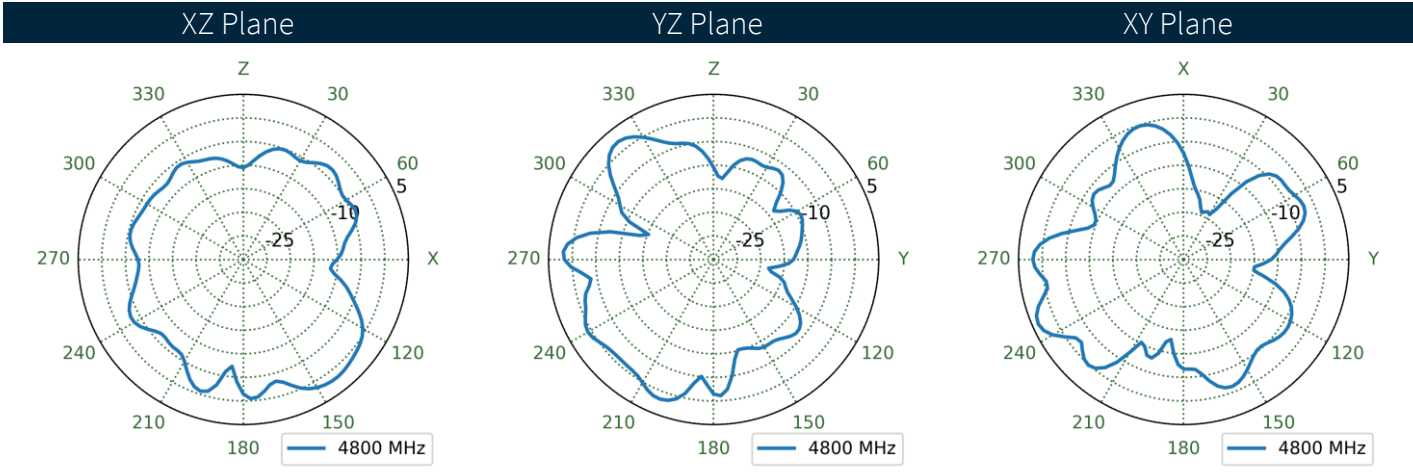
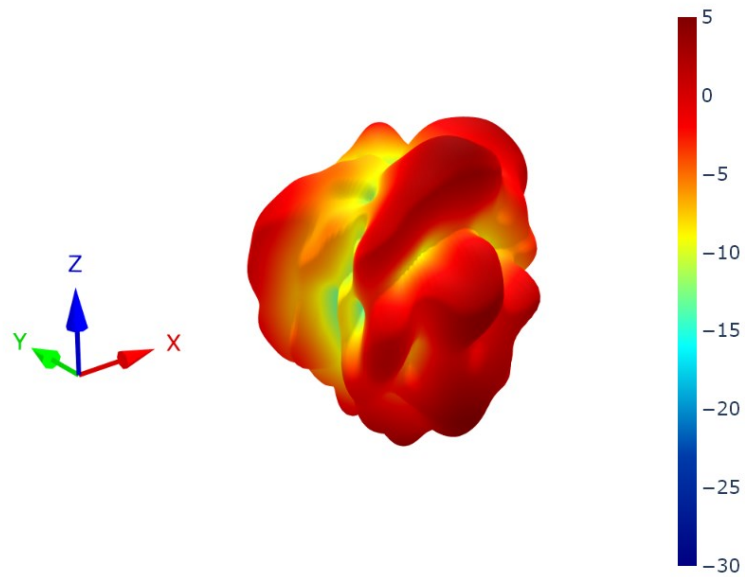

7.52 LTE3 Patterns at 4800 MHz

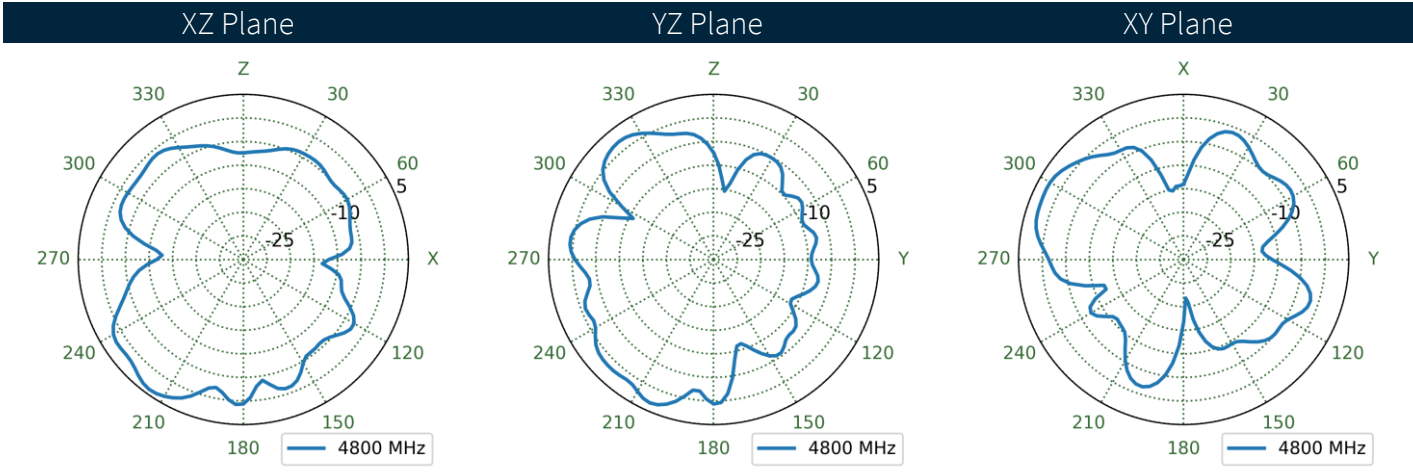
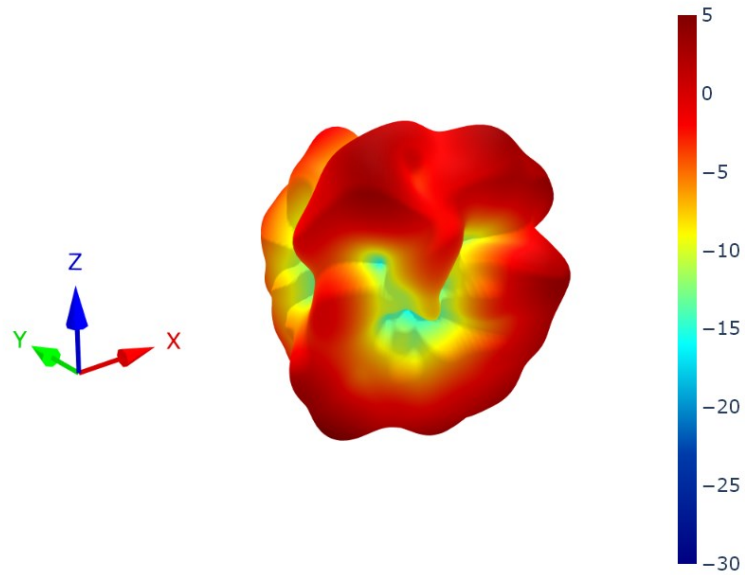

7.53 LTE4 Patterns at 4800 MHz

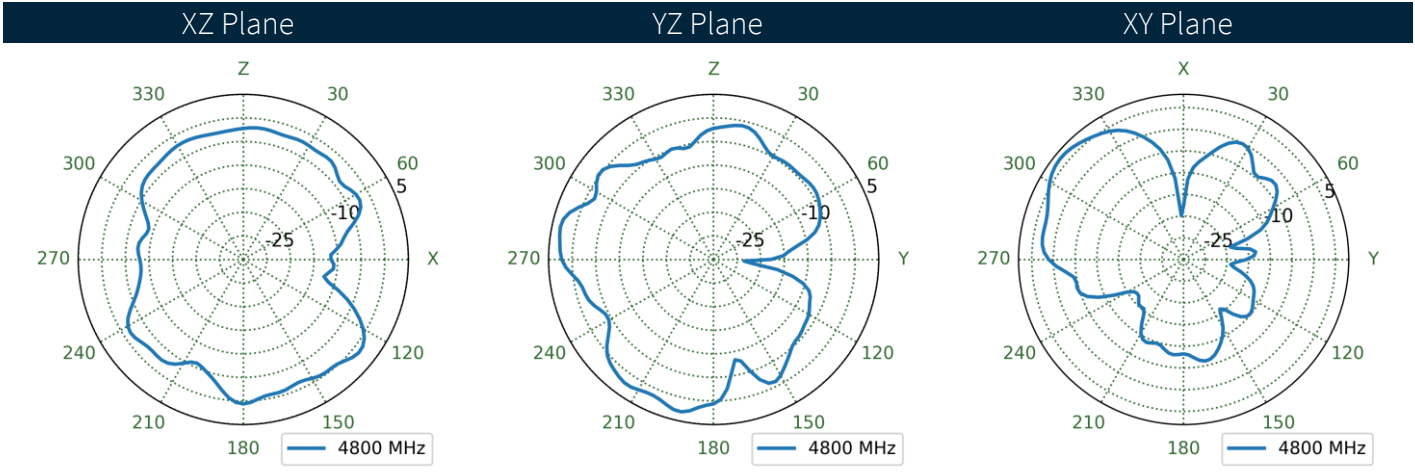
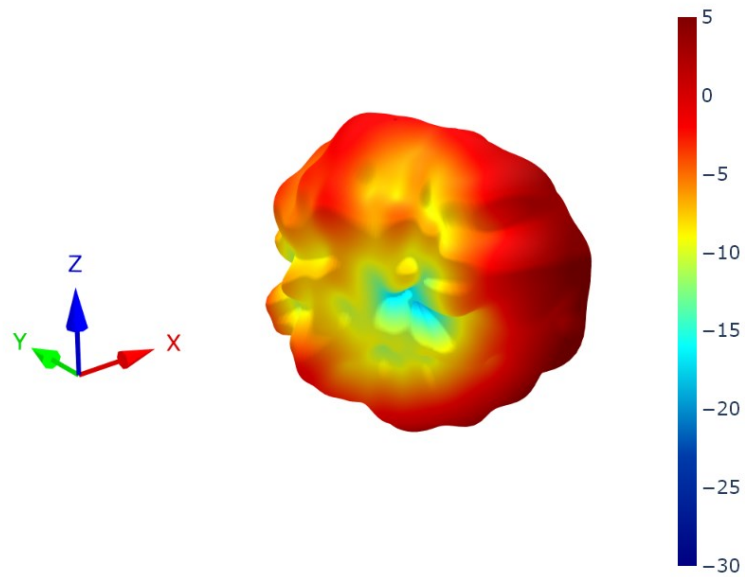

7.54 LTE1 Patterns at 5530 MHz

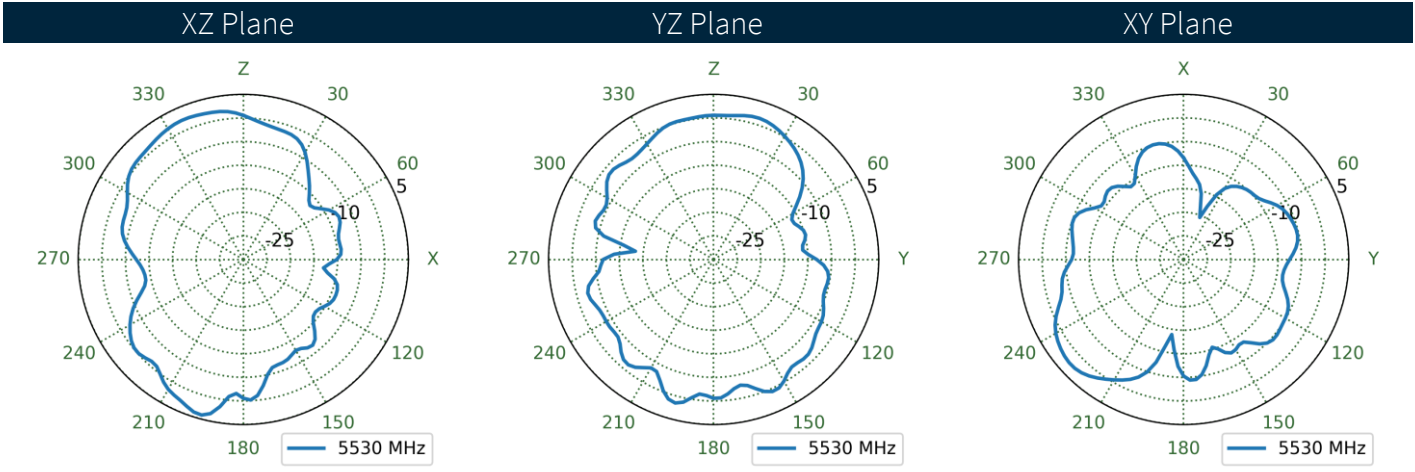
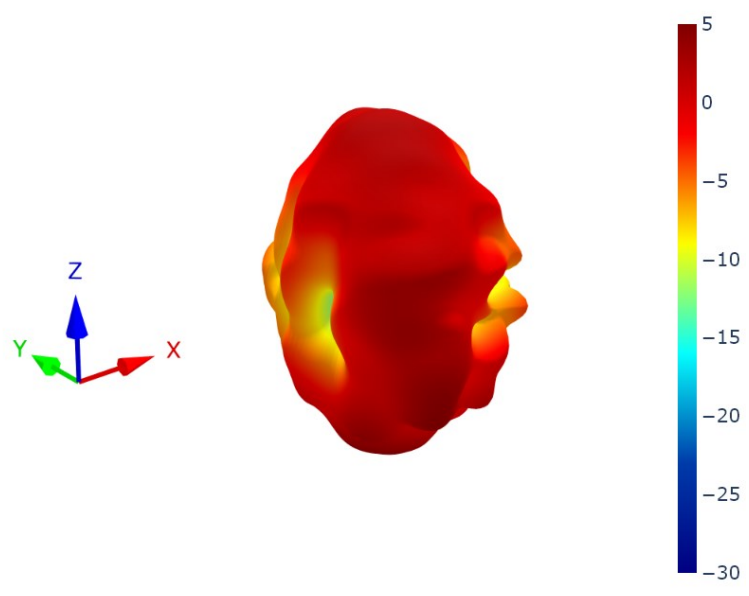

7.55 LTE2 Patterns at 5530 MHz

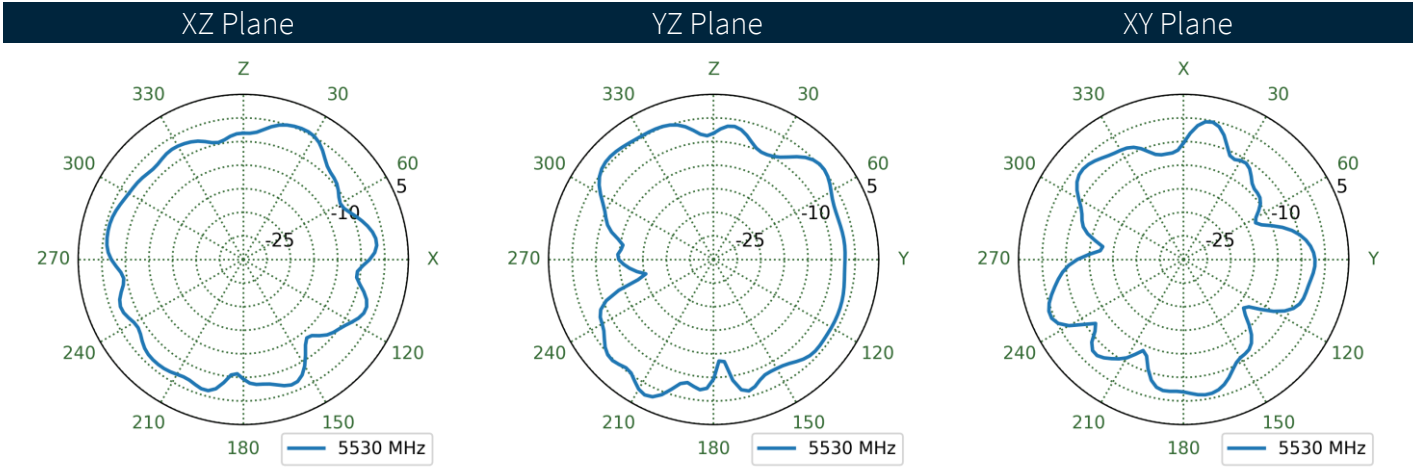
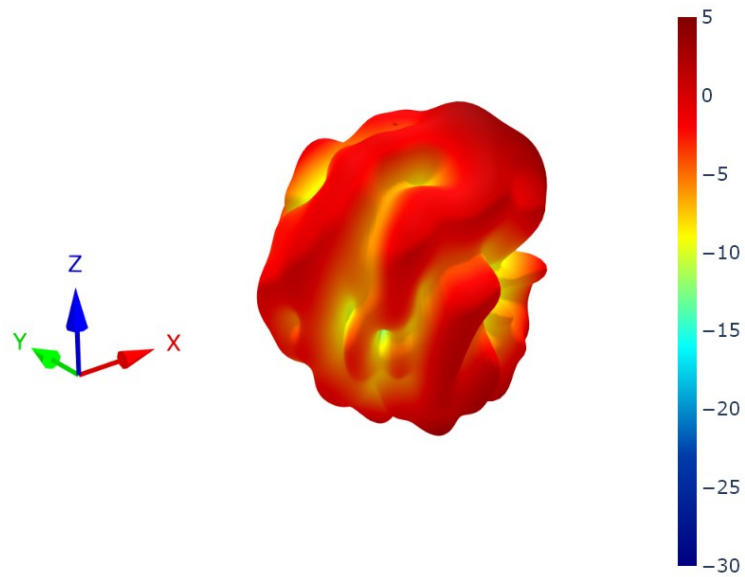

7.56 LTE3 Patterns at 5530 MHz

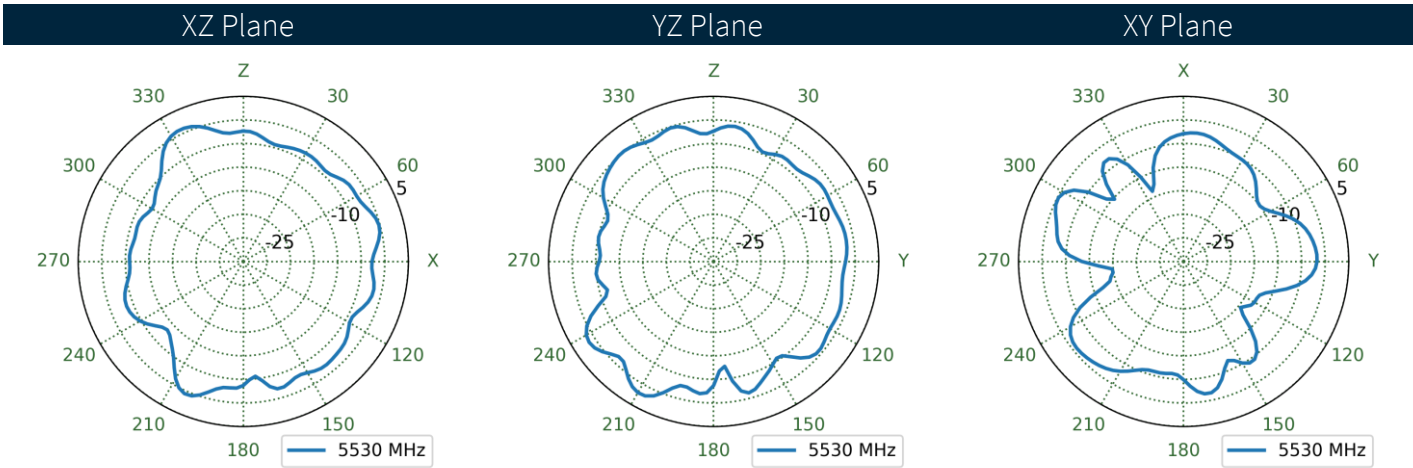
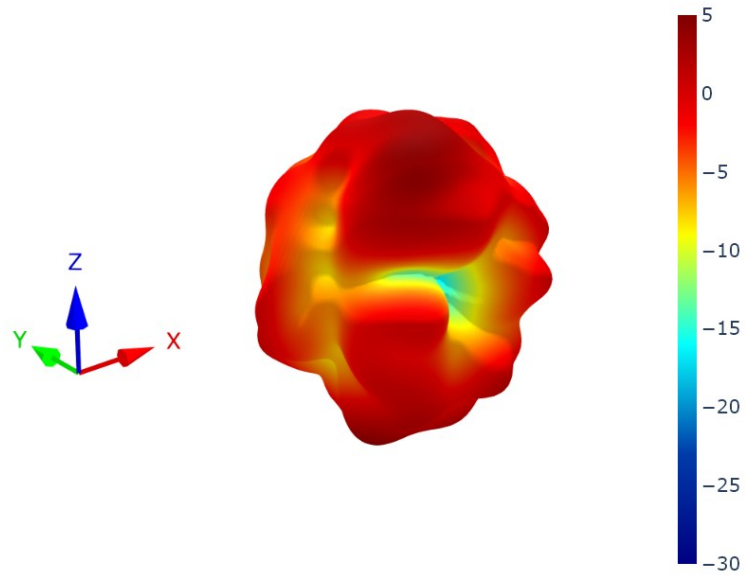

7.57 LTE4 Patterns at 5530 MHz

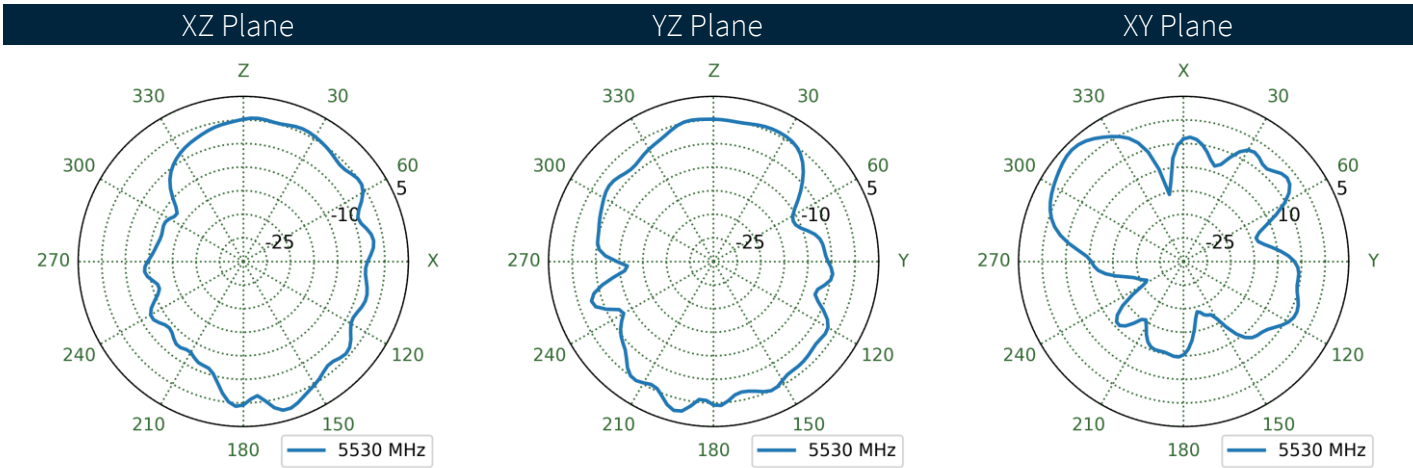
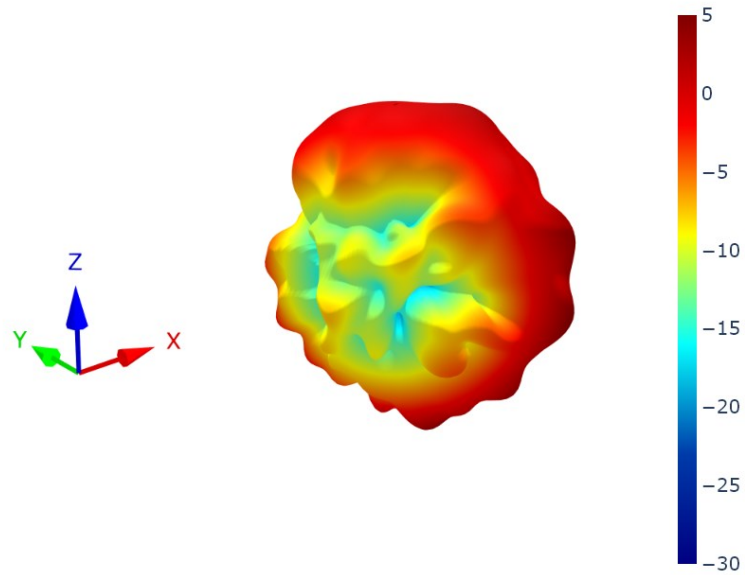

7.58 Wi-Fi1 Patterns at 2450 MHz

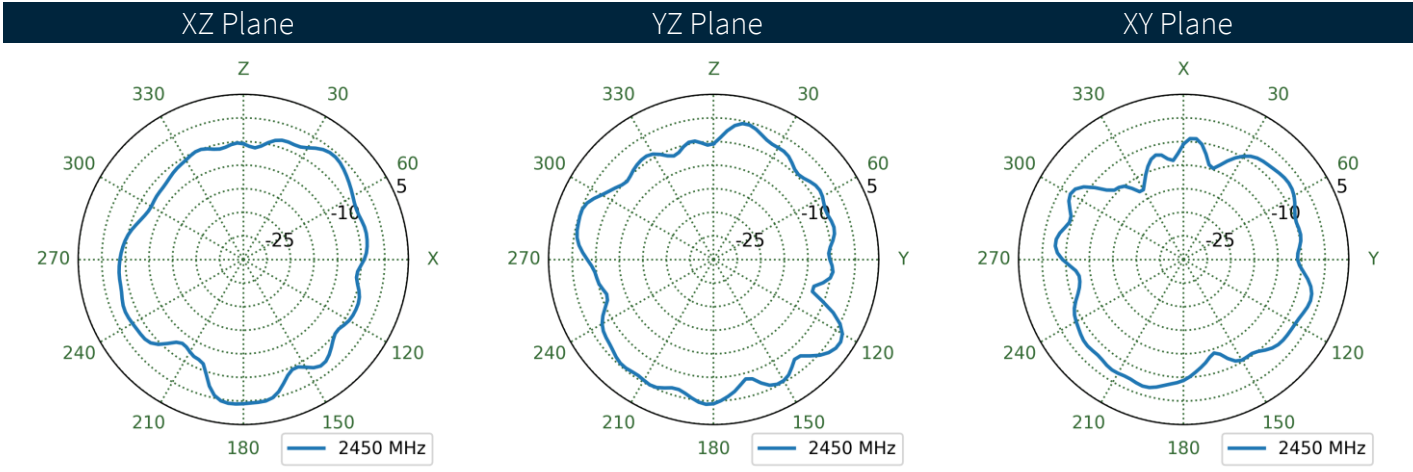
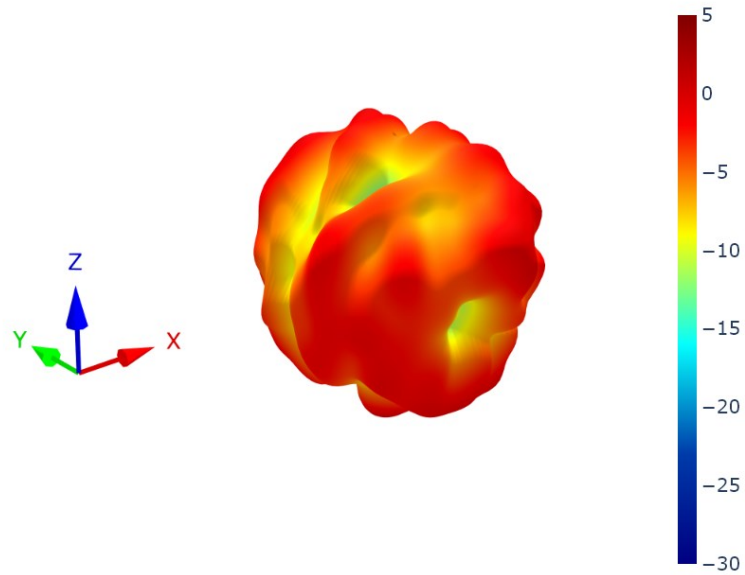

7.59 Wi-Fi2 Patterns at 2450 MHz

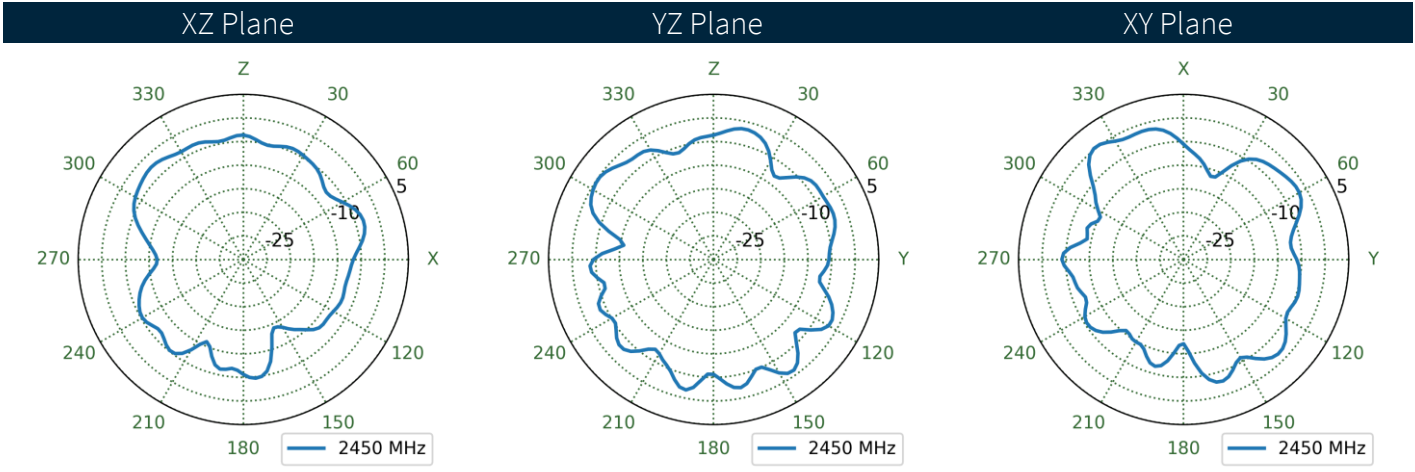
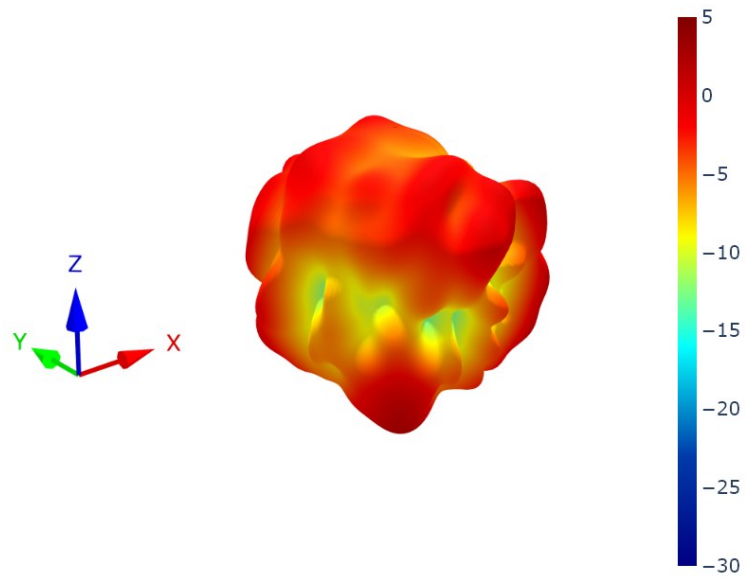

7.60 Wi-Fi1 Patterns at 5500 MHz

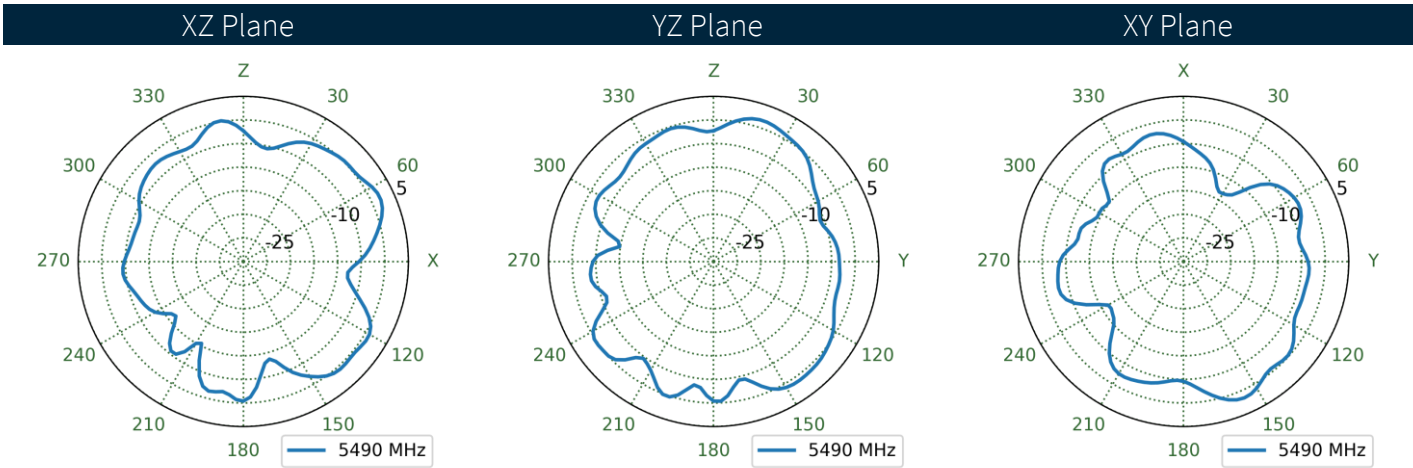
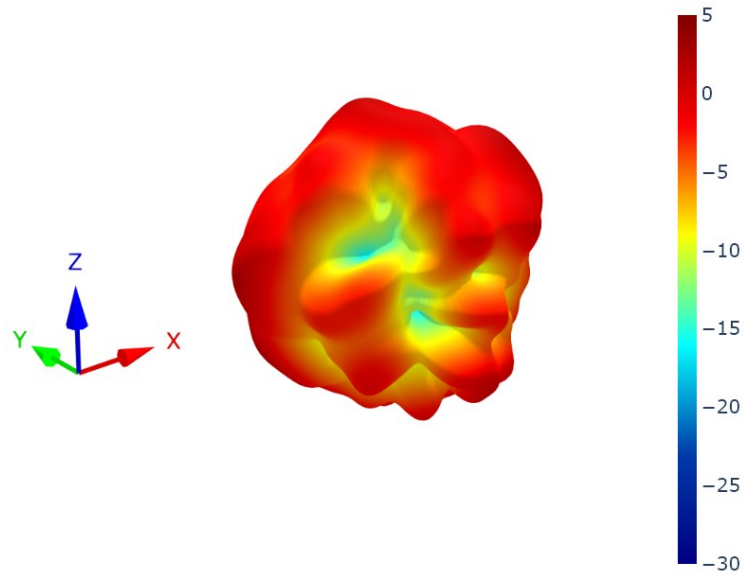

7.61 Wi-Fi2 Patterns at 5500 MHz

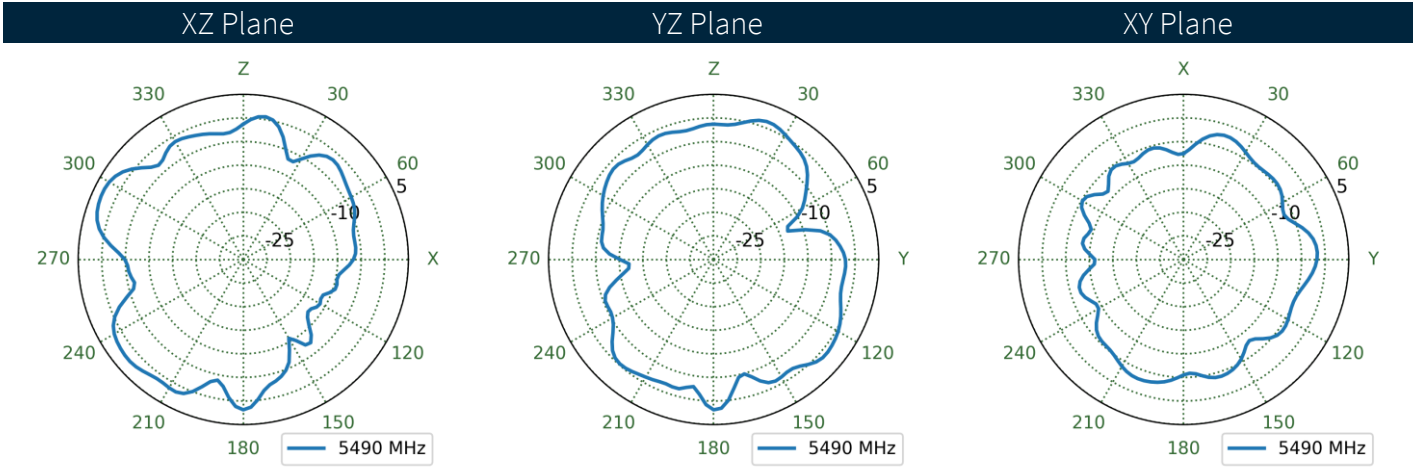
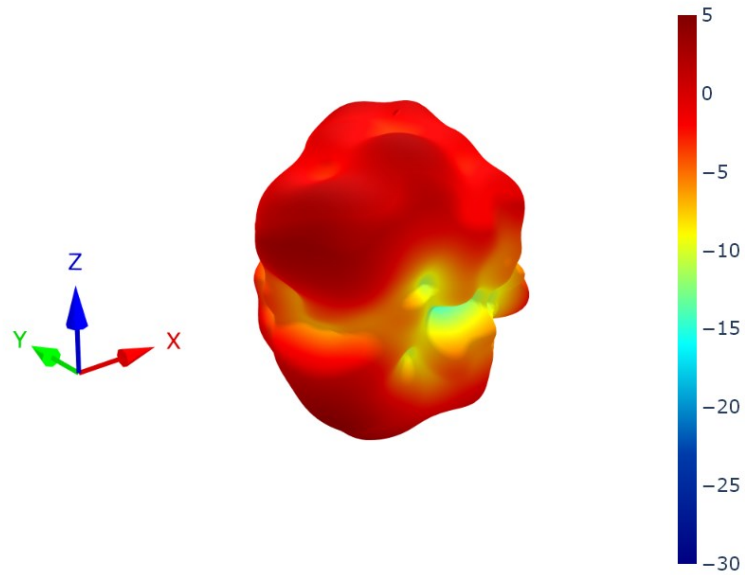

7.62 Wi-Fi1 Patterns at 6525 MHz

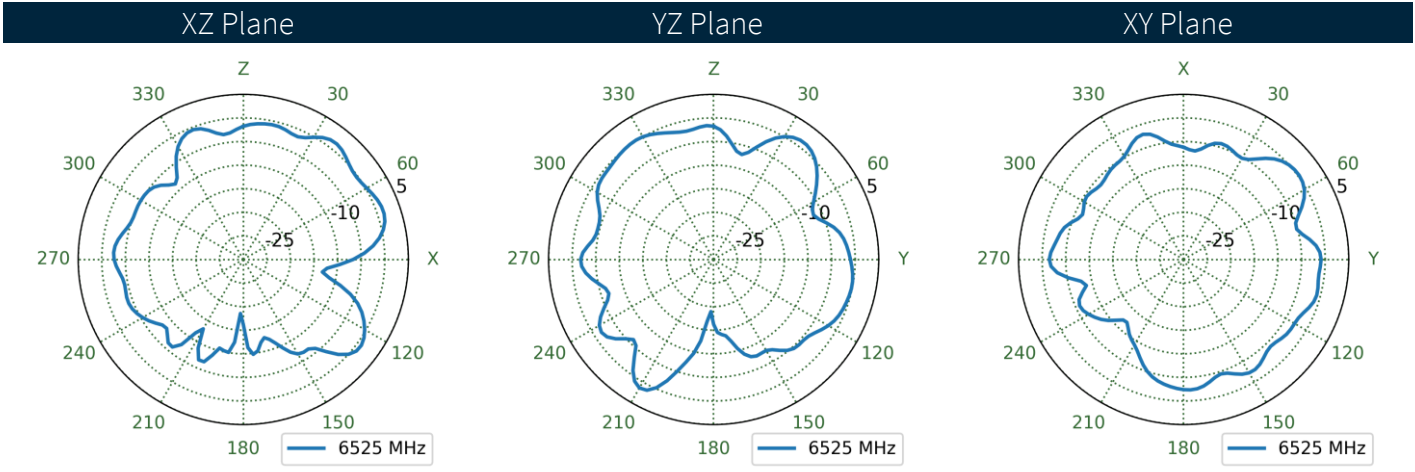
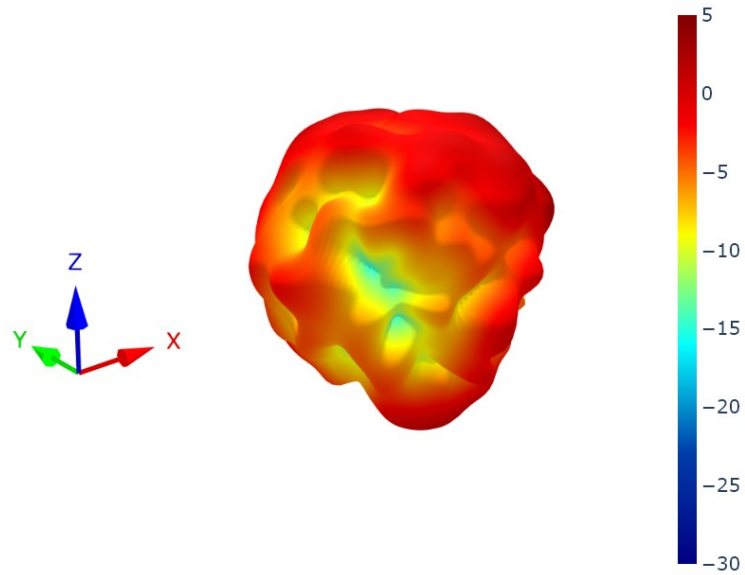

7.63 Wi-Fi2 Patterns at 6525 MHz

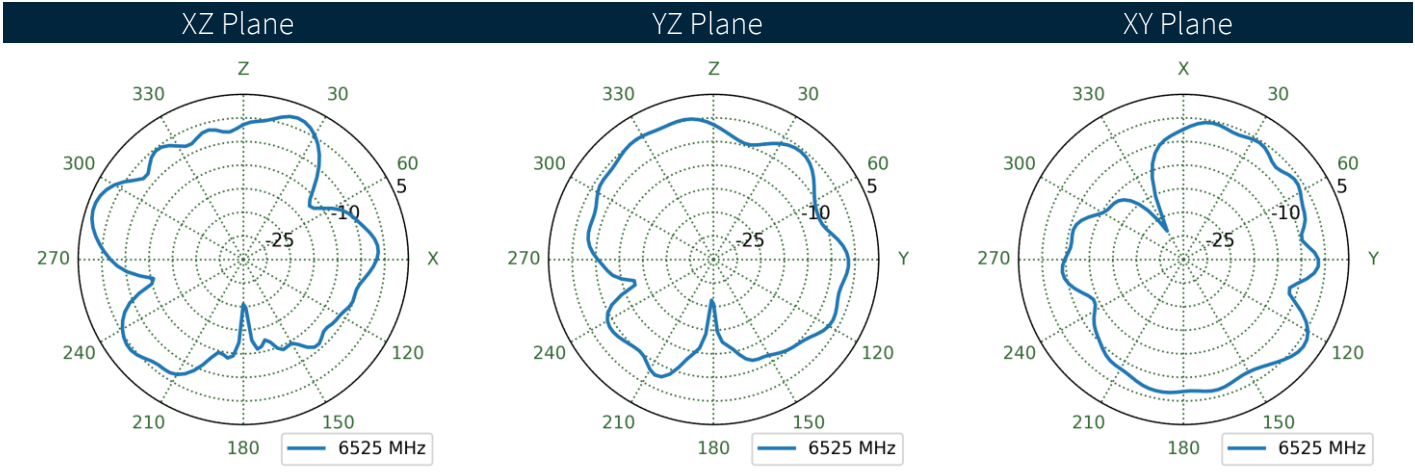
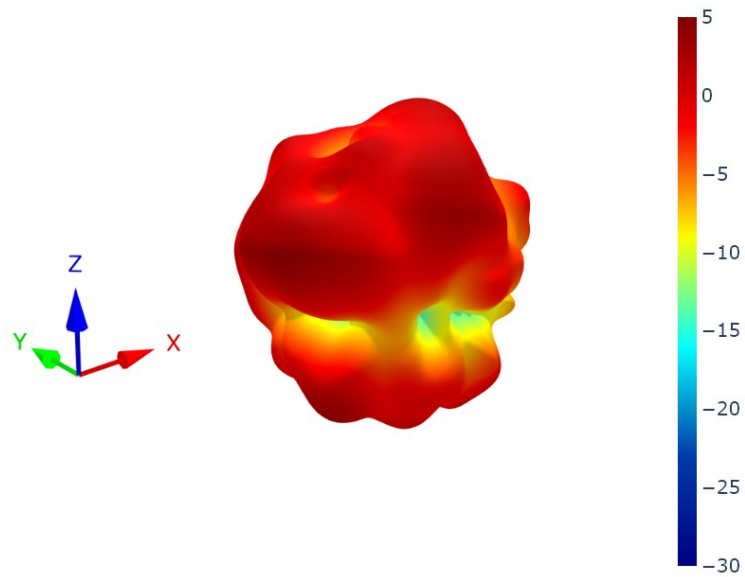

Changelog for the datasheet

SPE-24-8-112-A – MA997.A.003

Revision: A (Original First Release)

Date:	2024-06-20
Notes:	Initial Release
Author:	Cesar Sousa

Previous Revisions

