

Final datasheet

Short circuit rugged 1200 V TRENCHSTOP™ IGBT 7 technology

Features

- $V_{CE} = 1200\text{ V}$
- $I_C = 3\text{ A}$
- Low saturation voltage $V_{CEsat} = 2\text{ V}$ at $T_{vj} = 150^\circ\text{C}$
- Short circuit ruggedness $8\ \mu\text{s}$
- Wide range of dv/dt controllability
- Complete product spectrum and PSpice Models: <http://www.infineon.com/igbt/>

Potential applications

- Industrial drives

Product validation

- Qualified for industrial applications according to the relevant tests of JEDEC47/20/22
- Encapsulation for the application required

Description

Package pin definition:

- Pin 1 (G) - gate
- Pin 2 (E) - emitter
- TAB (C) - collector

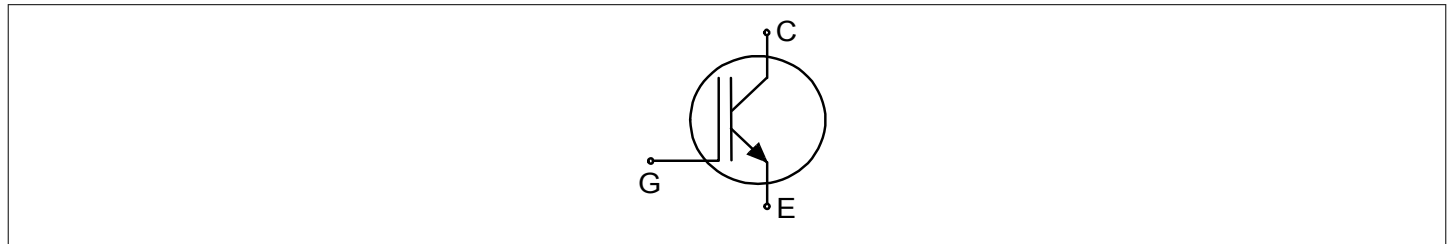
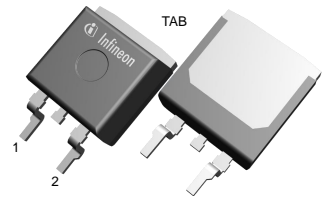

Type	Package	Marking
IGB03N120S7	PG-TO263-3-STD-C1.6	G03MS7

Table of contents

	Description	1
	Features	1
	Potential applications	1
	Product validation	1
	Table of contents	2
1	Package	3
2	IGBT	3
3	Characteristics diagrams	6
4	Package outlines	11
5	Testing conditions	12
	Revision history	13
	Disclaimer	14

1 Package

Table 1 Characteristic values

Parameter	Symbol	Note or test condition	Values			Unit
			Min.	Typ.	Max.	
Internal emitter inductance measured 5 mm (0.197 in.) from case	L_E			7		nH
Storage temperature	T_{stg}		-55		150	°C
Soldering temperature	T_{sold}	reflow soldering (MSL1 according to JEDEC J-STA-020)			260	°C
Thermal resistance, 6 cm ² Cu on PCB junction to ambient	$R_{th(j-a)}$				40	K/W
IGBT thermal resistance, junction-case	$R_{th(j-c)}$			2.51	3.39	K/W

2 IGBT

Table 2 Maximum rated values

Parameter	Symbol	Note or test condition	Values	Unit
Collector-emitter voltage	V_{CE}	$T_{vj} \geq 25 \text{ °C}$	1200	V
DC collector current, limited by T_{vjmax}	I_C	$T_c = 25 \text{ °C}$	9	A
		$T_c = 100 \text{ °C}$	5	
Pulsed collector current, t_p limited by T_{vjmax}	I_{Cpulse}		9	A
Turn-off safe operating area		$V_{CE} \leq 1200 \text{ V}, T_{vj} \leq 150 \text{ °C}$	9	A
Gate-emitter voltage	V_{GE}		±20	V
Transient gate-emitter voltage	V_{GE}	$t_p \leq 0.5 \text{ } \mu\text{s}, D < 0.001$	±25	V
Short-circuit withstand time	t_{SC}	$V_{CC} \leq 600 \text{ V}, V_{GE} = 15 \text{ V}$, Allowed number of short circuits < 1000, Time between short circuits $\geq 1.0 \text{ s}, T_{vj} = 150 \text{ °C}$	8	μs
Power dissipation	P_{tot}	$T_c = 25 \text{ °C}$	37	W
		$T_c = 100 \text{ °C}$	15	

Table 3 Characteristic values

Parameter	Symbol	Note or test condition		Values			Unit
				Min.	Typ.	Max.	
Collector-emitter saturation voltage	V_{CEsat}	$I_C = 3\text{ A}, V_{GE} = 15\text{ V}$	$T_{vj} = 25\text{ °C}$		1.65	2	V
			$T_{vj} = 150\text{ °C}$		2		
Gate-emitter threshold voltage	V_{GETh}	$I_C = 0.06\text{ mA}, V_{CE} = V_{GE}$		5.15	5.7	6.45	V
Zero gate-voltage collector current	I_{CES}	$V_{CE} = 1200\text{ V}, V_{GE} = 0\text{ V}$	$T_{vj} = 25\text{ °C}$			20	μA
			$T_{vj} = 150\text{ °C}$		80		
Gate-emitter leakage current	I_{GES}	$V_{CE} = 0\text{ V}, V_{GE} = 20\text{ V}$				100	nA
Transconductance	g_{fs}	$I_C = 3\text{ A}, V_{CE} = 20\text{ V}, T_{vj} = 150\text{ °C}$			1.8		S
Short-circuit collector current	I_{SC}	$V_{CC} \leq 600\text{ V}, V_{GE} = 15\text{ V}, t_{SC} \leq 8\text{ }\mu\text{s}$, Allowed number of short circuits < 1000, Time between short circuits $\geq 1.0\text{ s}$, $T_{vj} = 150\text{ °C}$			15		A
Input capacitance	C_{ies}	$V_{CE} = 25\text{ V}, V_{GE} = 0\text{ V}, f = 100\text{ kHz}$			0.5		nF
Output capacitance	C_{oes}	$V_{CE} = 25\text{ V}, V_{GE} = 0\text{ V}, f = 100\text{ kHz}$			18		pF
Reverse transfer capacitance	C_{res}	$V_{CE} = 25\text{ V}, V_{GE} = 0\text{ V}, f = 100\text{ kHz}$			2		pF
Gate charge	Q_G	$V_{CC} = 960\text{ V}, I_C = 3\text{ A}, V_{GE} = 15\text{ V}$			24		nC
Turn-on delay time	$t_{d(on)}$	$V_{CC} = 600\text{ V}, V_{GE} = 0/15\text{ V}, R_{G(on)} = 60\text{ }\Omega, R_{G(off)} = 60\text{ }\Omega$	$T_{vj} = 25\text{ °C}, I_C = 3\text{ A}$		19		ns
			$T_{vj} = 150\text{ °C}, I_C = 3\text{ A}$		18		
Rise time (inductive load)	t_r	$V_{CC} = 600\text{ V}, V_{GE} = 0/15\text{ V}, R_{G(on)} = 60\text{ }\Omega, R_{G(off)} = 60\text{ }\Omega$	$T_{vj} = 25\text{ °C}, I_C = 3\text{ A}$		15		ns
			$T_{vj} = 150\text{ °C}, I_C = 3\text{ A}$		18		
Turn-off delay time	$t_{d(off)}$	$V_{CC} = 600\text{ V}, V_{GE} = 0/15\text{ V}, R_{G(on)} = 60\text{ }\Omega, R_{G(off)} = 60\text{ }\Omega$	$T_{vj} = 25\text{ °C}, I_C = 3\text{ A}$		89		ns
			$T_{vj} = 150\text{ °C}, I_C = 3\text{ A}$		142		
Fall time (inductive load)	t_f	$V_{CC} = 600\text{ V}, V_{GE} = 0/15\text{ V}, R_{G(on)} = 60\text{ }\Omega, R_{G(off)} = 60\text{ }\Omega$	$T_{vj} = 25\text{ °C}, I_C = 3\text{ A}$		203		ns
			$T_{vj} = 150\text{ °C}, I_C = 3\text{ A}$		272		
Turn-on energy	E_{on}	$V_{CC} = 600\text{ V}, V_{GE} = 0/15\text{ V}, R_{G(on)} = 60\text{ }\Omega, R_{G(off)} = 60\text{ }\Omega$	$T_{vj} = 25\text{ °C}, I_C = 3\text{ A}$		0.21		mJ
			$T_{vj} = 150\text{ °C}, I_C = 3\text{ A}$		0.29		
Turn-off energy	E_{off}	$V_{CC} = 600\text{ V}, V_{GE} = 0/15\text{ V}, R_{G(on)} = 60\text{ }\Omega, R_{G(off)} = 60\text{ }\Omega$	$T_{vj} = 25\text{ °C}, I_C = 3\text{ A}$		0.16		mJ
			$T_{vj} = 150\text{ °C}, I_C = 3\text{ A}$		0.27		

(table continues...)

Table 3 (continued) Characteristic values

Parameter	Symbol	Note or test condition	Values			Unit
			Min.	Typ.	Max.	
Total switching energy	E_{ts}	$V_{CC} = 600\text{ V}, V_{GE} = 0/15\text{ V},$ $R_{G(on)} = 60\ \Omega,$ $R_{G(off)} = 60\ \Omega$	$T_{vj} = 25\text{ °C}, I_C = 3\text{ A}$		0.37	mJ
			$T_{vj} = 150\text{ °C},$ $I_C = 3\text{ A}$		0.56	
Operating junction temperature	T_{vj}		-40		150	°C

Note: For optimum lifetime and reliability, Infineon recommends operating conditions that do not exceed 80% of the maximum ratings stated in this datasheet.

Electrical Characteristic at $T_{vj} = 25\text{ °C}$, unless otherwise specified.

Dynamic test circuit, parasitic inductance $L_\sigma = 45\text{ nH}$, parasitic capacitor $C_\sigma = 25\text{ pF}$ from Fig. E. Energy losses include “tail” and diode reverse recovery.

3 Characteristics diagrams

Typical output characteristic

$I_C = f(V_{CE})$
 $T_{vj} = 25\text{ °C}$

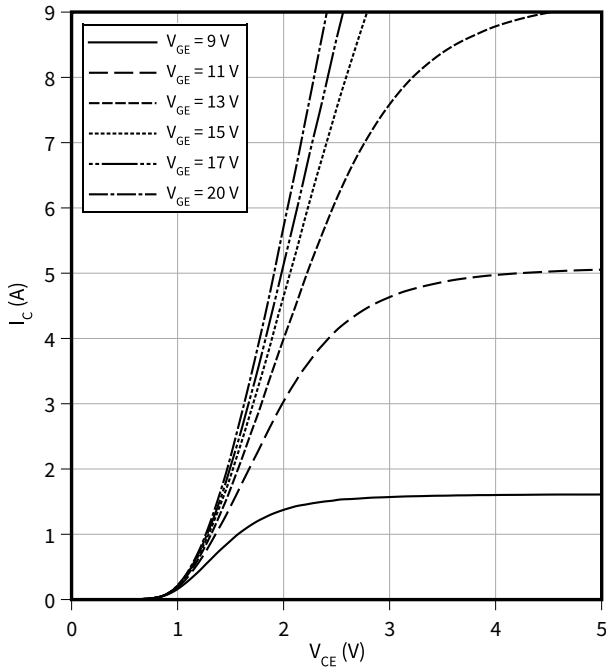

Typical output characteristic

$I_C = f(V_{CE})$
 $T_{vj} = 150\text{ °C}$

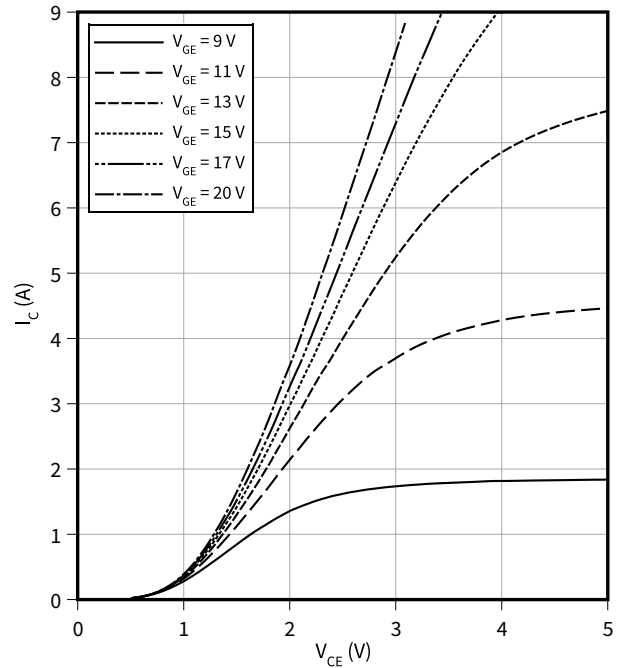

Typical transfer characteristic

$I_C = f(V_{GE})$
 $V_{CE} = 20\text{ V}$

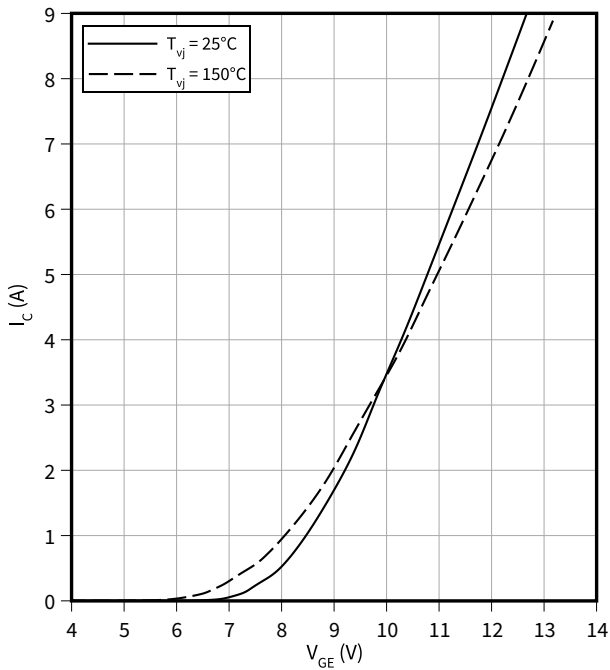

Typical collector-emitter saturation voltage as a function of junction temperature

$V_{CEsat} = f(T_{vj})$
 $V_{GE} = 15\text{ V}$

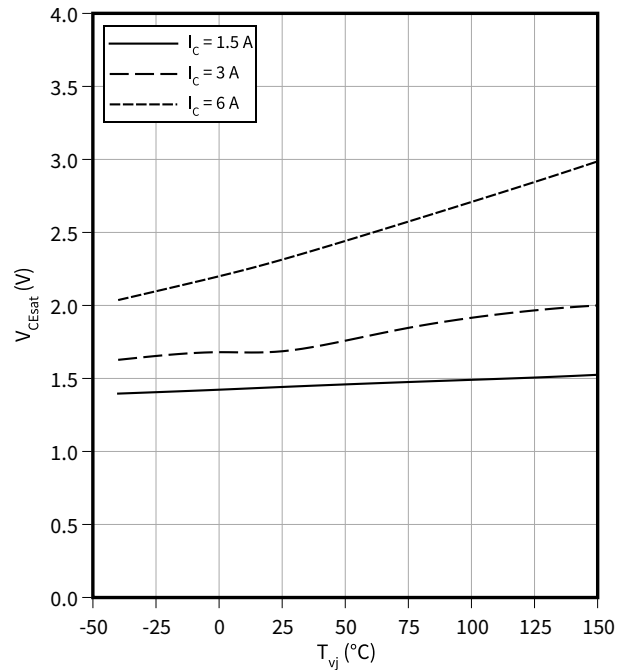

3 Characteristics diagrams

Gate-emitter threshold voltage as a function of junction temperature

$V_{GEth} = f(T_{vj})$
 $I_C = 0.06 \text{ mA}$

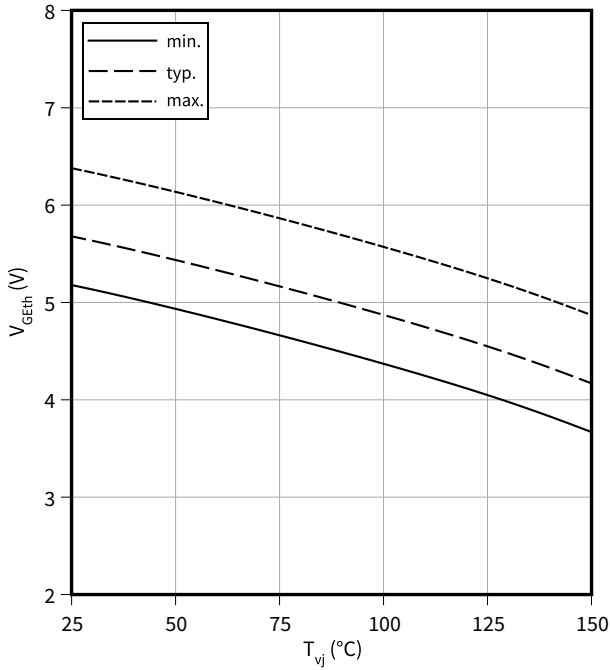

Typical switching times as a function of collector current

$t = f(I_C)$
 $V_{CC} = 600 \text{ V}, T_{vj} = 150 \text{ °C}, V_{GE} = 0/15 \text{ V}, R_G = 60 \text{ } \Omega$

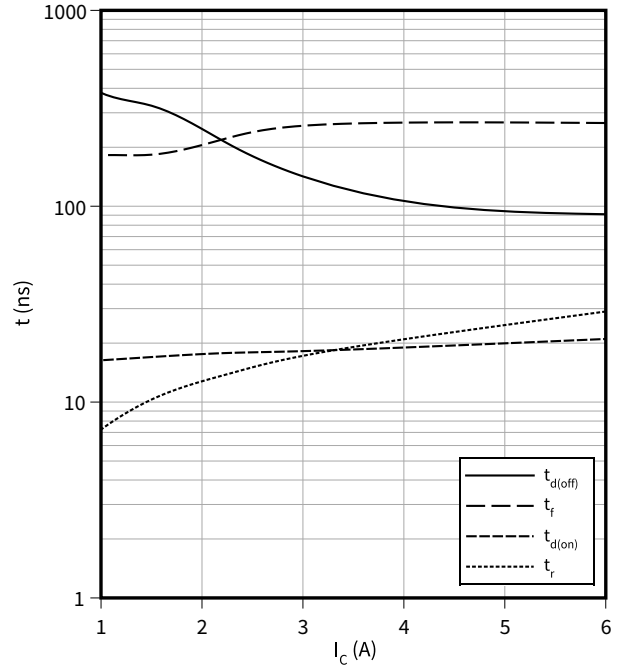

Typical switching times as a function of gate resistor

$t = f(R_G)$
 $I_C = 3 \text{ A}, V_{CC} = 600 \text{ V}, T_{vj} = 150 \text{ °C}, V_{GE} = 0/15 \text{ V}$

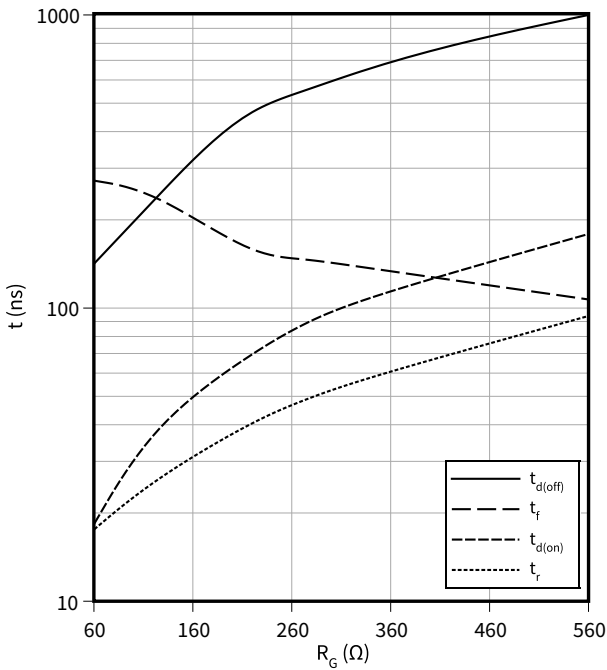

Typical switching times as a function of junction temperature

$t = f(T_{vj})$
 $I_C = 3 \text{ A}, V_{CC} = 600 \text{ V}, V_{GE} = 0/15 \text{ V}, R_G = 60 \text{ } \Omega$

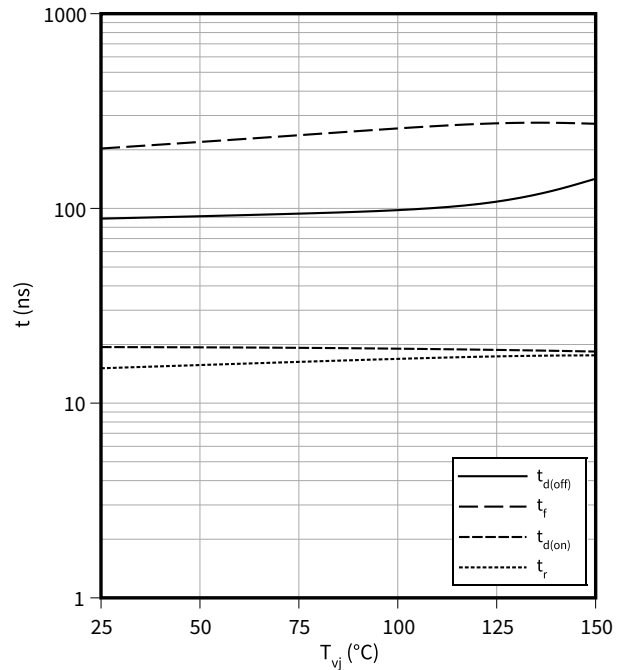

3 Characteristics diagrams

Typical switching energy losses as a function of collector current

$E = f(I_C)$

$V_{CC} = 600\text{ V}, T_{vj} = 150\text{ °C}, V_{GE} = 0/15\text{ V}, R_G = 60\text{ }\Omega$

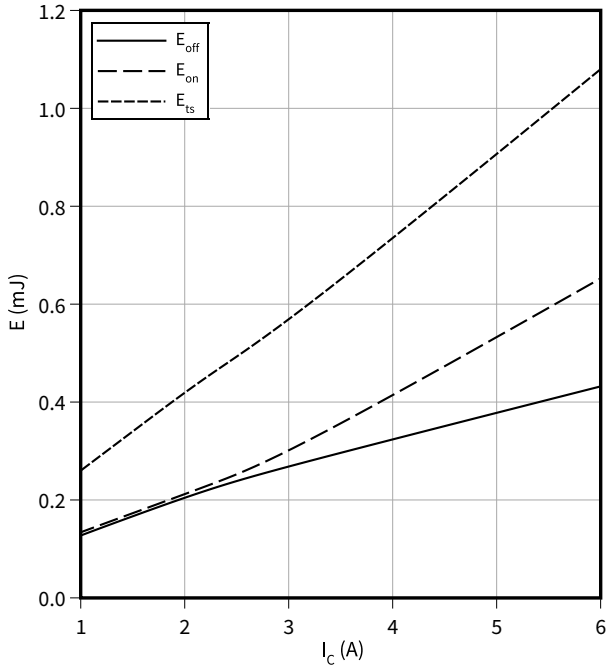

Typical switching energy losses as a function of gate resistor

$E = f(R_G)$

$I_C = 3\text{ A}, V_{CC} = 600\text{ V}, T_{vj} = 150\text{ °C}, V_{GE} = 0/15\text{ V}$

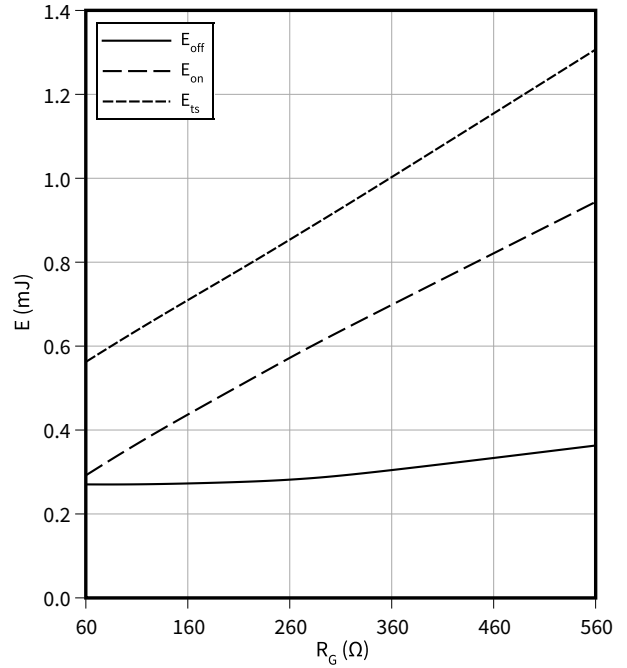

Typical switching energy losses as a function of junction temperature

$E = f(T_{vj})$

$I_C = 3\text{ A}, V_{CC} = 600\text{ V}, V_{GE} = 0/15\text{ V}, R_G = 60\text{ }\Omega$

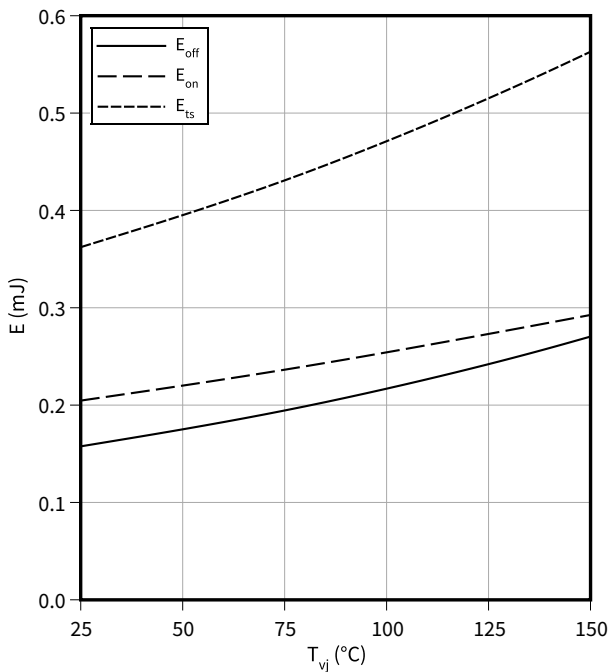

Typical switching energy losses as a function of collector emitter voltage

$E = f(V_{CE})$

$I_C = 3\text{ A}, T_{vj} = 150\text{ °C}, V_{GE} = 0/15\text{ V}, R_G = 60\text{ }\Omega$

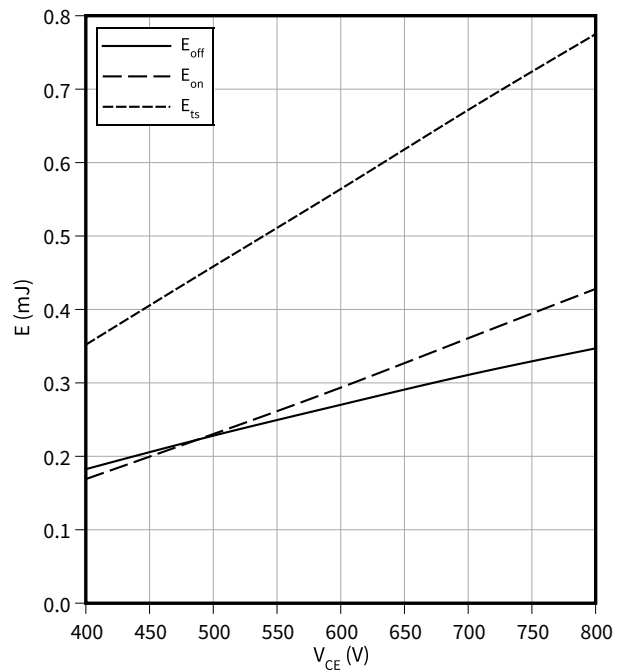

3 Characteristics diagrams

Typical gate charge

$V_{GE} = f(Q_G)$

$I_C = 3 \text{ A}$

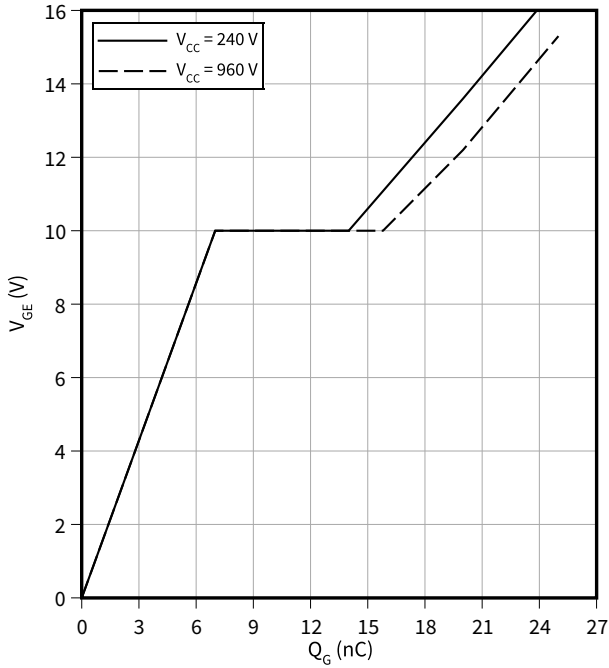

Typical capacitance as a function of collector-emitter voltage

$C = f(V_{CE})$

$f = 100 \text{ kHz}, V_{GE} = 0 \text{ V}$

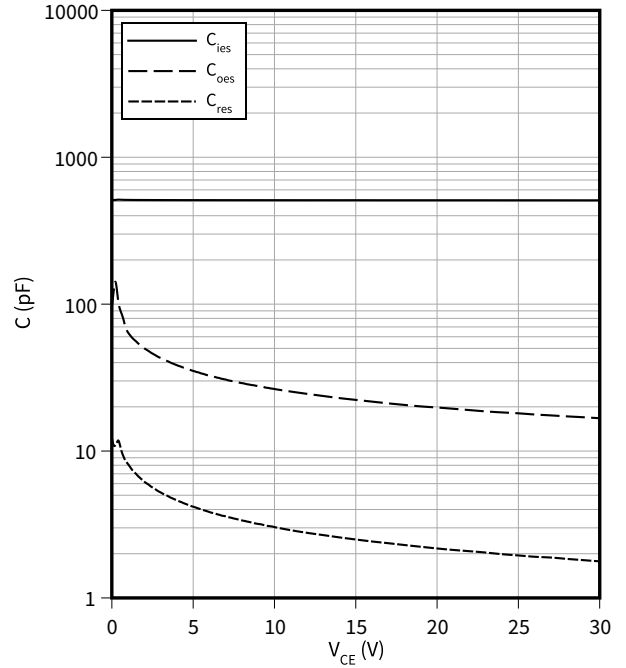

Typical short circuit collector current as a function of gate-emitter voltage

$I_{C(SC)} = f(V_{GE})$

$T_{vj} = 150 \text{ }^\circ\text{C}, V_{CC} = 600 \text{ V}$

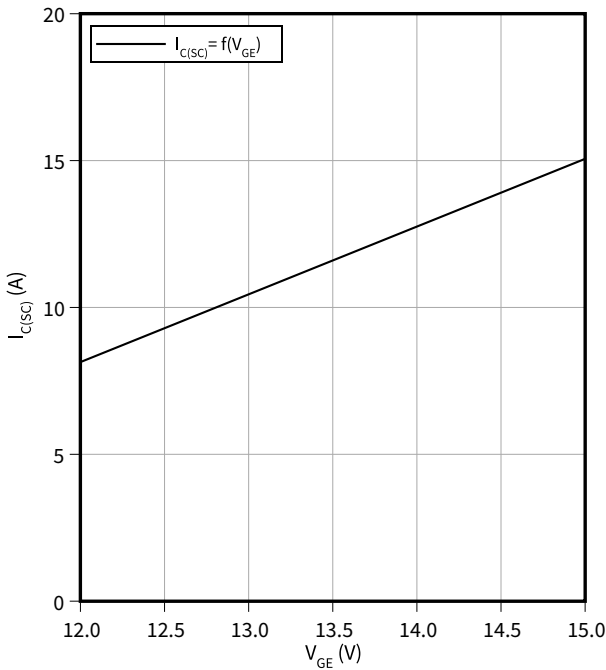

Short circuit withstand time as a function of gate-emitter voltage

$t_{SC} = f(V_{GE})$

$T_{vj} = 150 \text{ }^\circ\text{C}, V_{CC} = 600 \text{ V}$

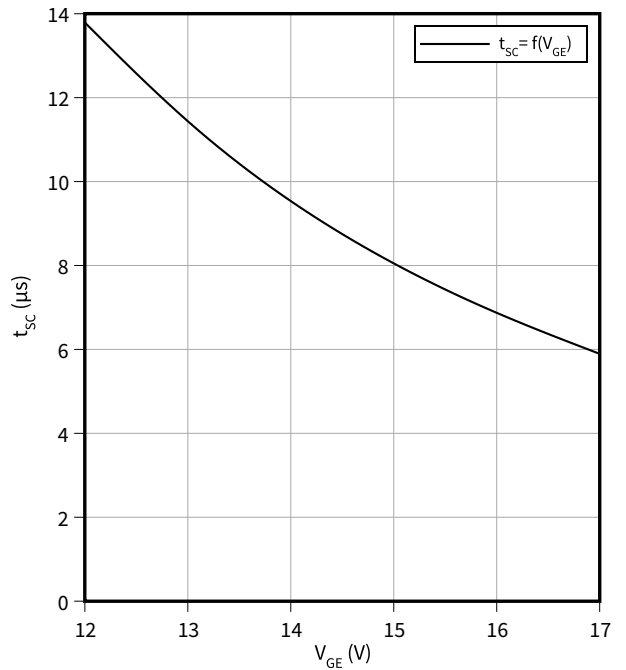

3 Characteristics diagrams

IGBT transient thermal impedance as a function of pulse width

$$Z_{th(j-c)} = f(t_p)$$

$$D = t_p/T$$

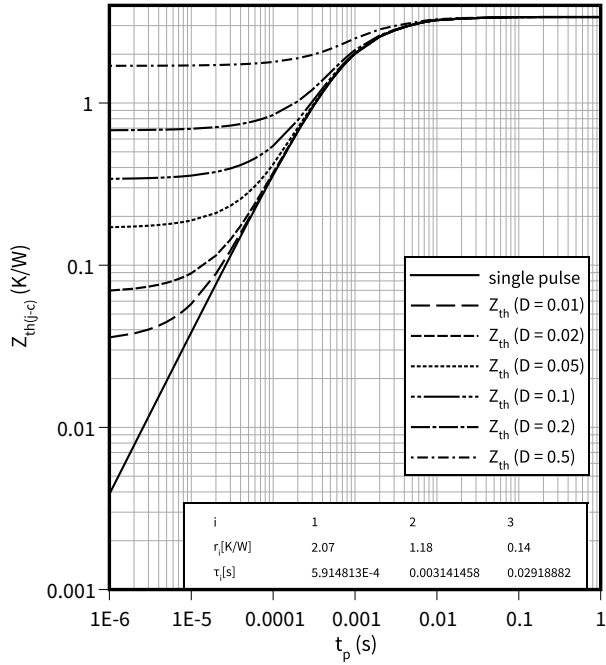

4 Package outlines

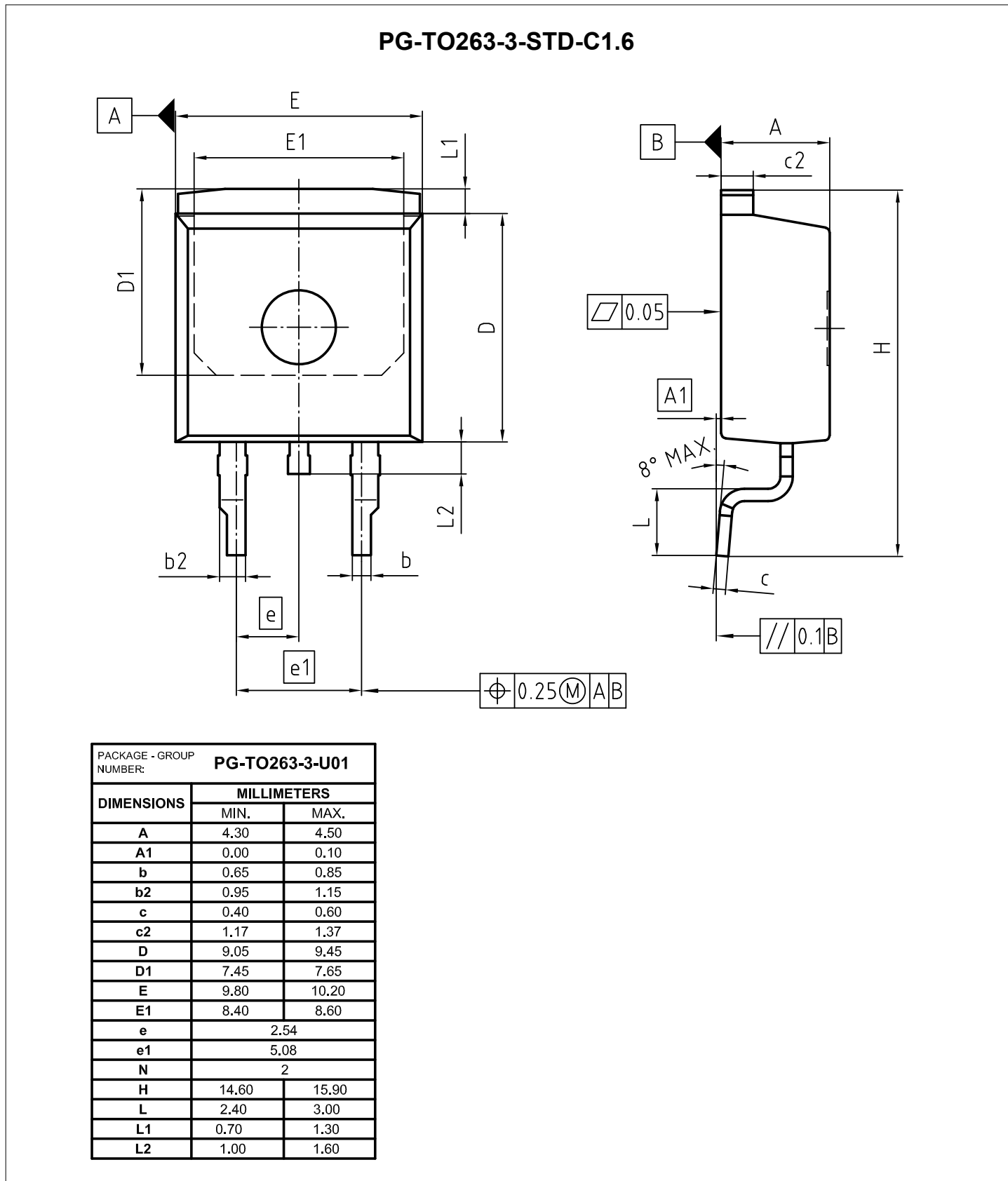

Figure 1

5 Testing conditions

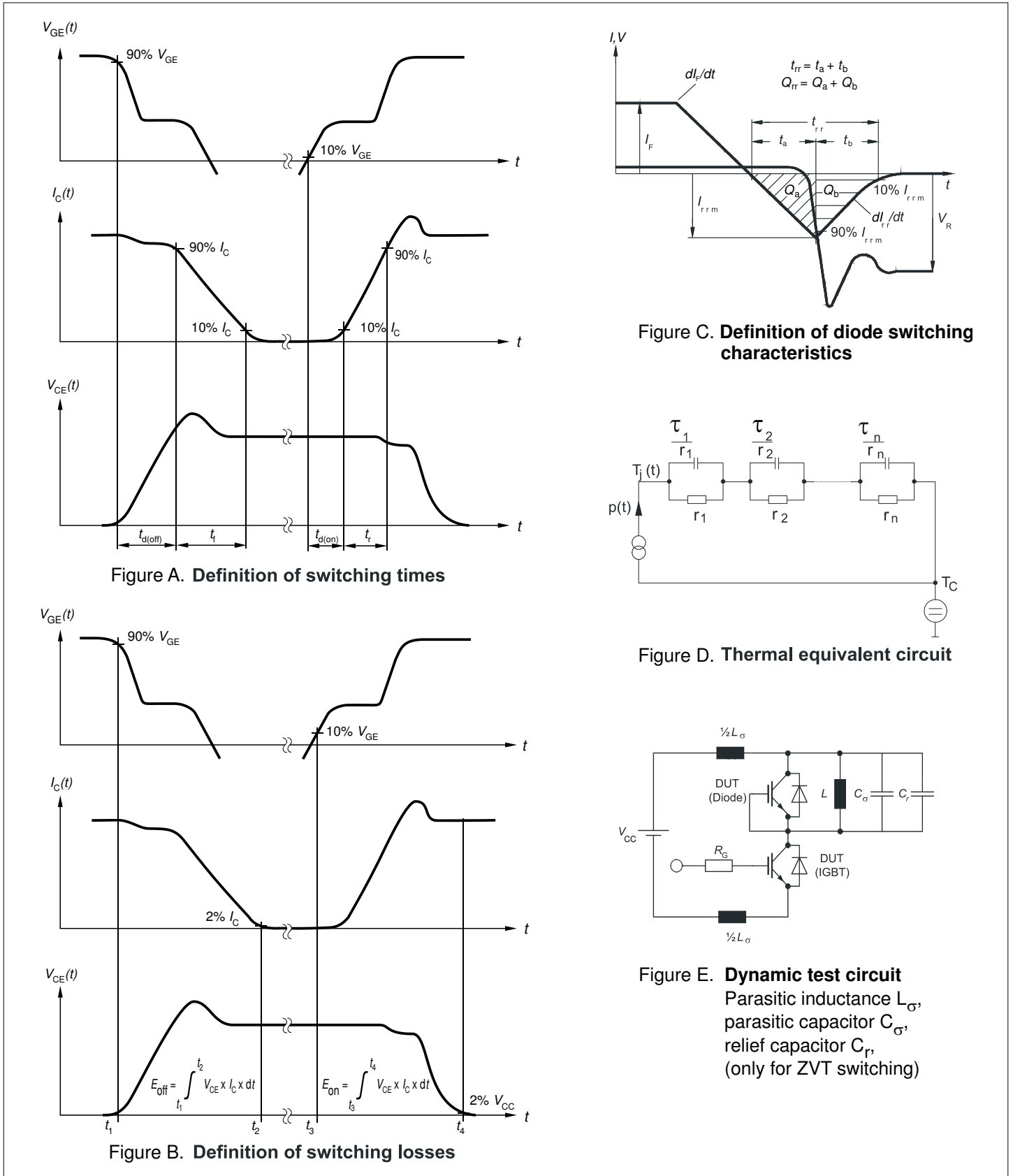

Figure 2

Revision history

Document revision	Date of release	Description of changes
1.00	2024-03-11	Final datasheet

Trademarks

All referenced product or service names and trademarks are the property of their respective owners.

Edition 2024-03-11

Published by

Infineon Technologies AG

81726 Munich, Germany

© 2024 Infineon Technologies AG

All Rights Reserved.

Do you have a question about any aspect of this document?

Email: erratum@infineon.com

Document reference

IFX-ABJ879-001

Important notice

The information given in this document shall in no event be regarded as a guarantee of conditions or characteristics ("Beschaffheitsgarantie").

With respect to any examples, hints or any typical values stated herein and/or any information regarding the application of the product, Infineon Technologies hereby disclaims any and all warranties and liabilities of any kind, including without limitation warranties of non-infringement of intellectual property rights of any third party.

In addition, any information given in this document is subject to customer's compliance with its obligations stated in this document and any applicable legal requirements, norms and standards concerning customer's products and any use of the product of Infineon Technologies in customer's applications.

The data contained in this document is exclusively intended for technically trained staff. It is the responsibility of customer's technical departments to evaluate the suitability of the product for the intended application and the completeness of the product information given in this document with respect to such application.

Please note that this product is not qualified according to the AEC Q100 or AEC Q101 documents of the Automotive Electronics Council.

Warnings

Due to technical requirements products may contain dangerous substances. For information on the types in question please contact your nearest Infineon Technologies office.

Except as otherwise explicitly approved by Infineon Technologies in a written document signed by authorized representatives of Infineon Technologies, Infineon Technologies' products may not be used in any applications where a failure of the product or any consequences of the use thereof can reasonably be expected to result in personal injury.