

360052-1 ✓ ACTIVE

TE Internal #: 360052-1

3 Circuits, PBT, 22 – 10 AWG Wire Size, .326 – 5.26 mm<sup>2</sup> Wire Size,  
-20 – 120 °C [-4 – 248 °F], Cluster Blocks

[View on TE.com >](#)



Terminals & Splices > Terminal Housings, Insulation Sleeves & Blocks > Cluster Blocks

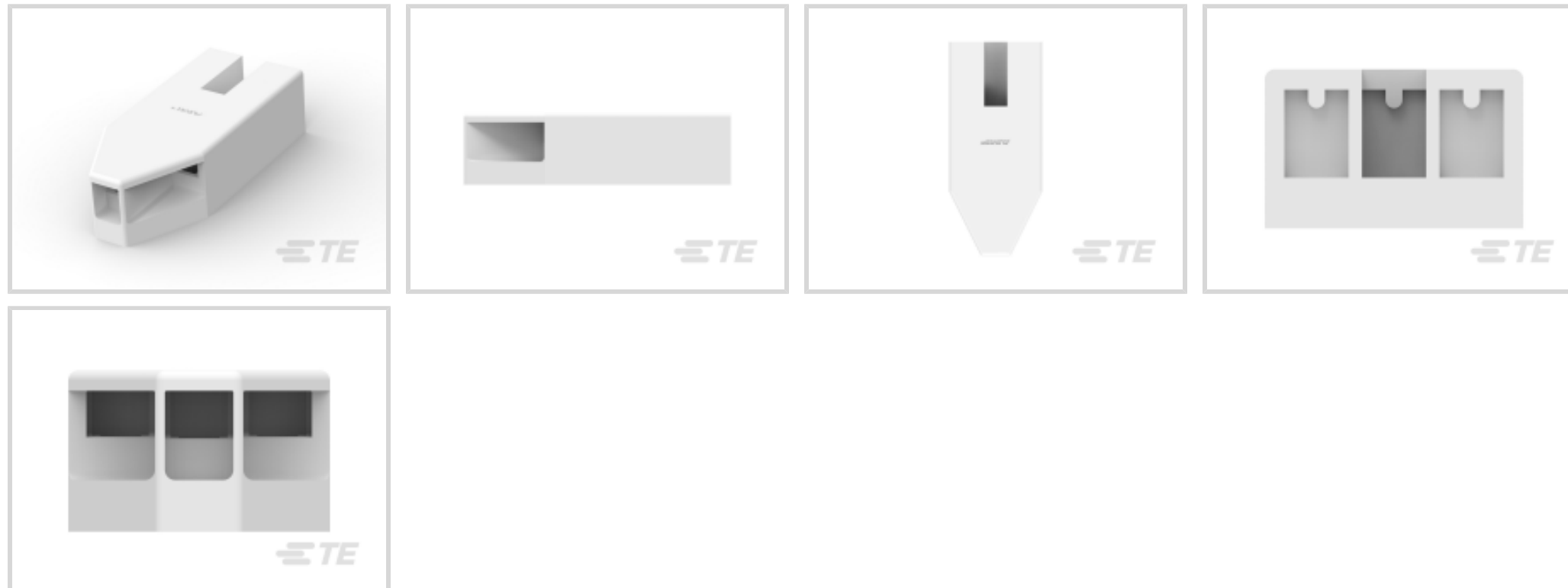

Number of Circuits: 3

Primary Product Material: PBT

Wire Size: .326 – 5.26 mm<sup>2</sup>

Operating Temperature Range: -20 – 120 °C [-4 – 248 °F]

## Features

### Configuration Features

Number of Circuits	3
--------------------	---

### Body Features

Primary Product Material	PBT
--------------------------	-----

Primary Product Color	Natural
-----------------------	---------

### Dimensions

Wire Size	.326 – 5.26 mm <sup>2</sup>
-----------	-----------------------------

Product Length	44.58 mm[1.76 in]
----------------	-------------------

### Usage Conditions

Operating Temperature Range	-20 – 120 °C[-4 – 248 °F]
-----------------------------	---------------------------

### Other

EU RoHS Compliance	Compliant
--------------------	-----------

EU ELV Compliance	Compliant
-------------------	-----------

### Product Type Features

Compatible With Discrete Wire Type	Lead Wire
------------------------------------	-----------

### Contact Features

Mating Pin Diameter	3.18 mm[.125 in]
---------------------	------------------

### Mechanical Attachment

Mount Diameter	13.46 mm[.53 in]
Block Mounting Configuration	1 Forward - 2 Back

### Industry Standards

UL Flammability Rating	UL 94HB
------------------------	---------

### Packaging Features

Packaging Method	Package
Packaging Quantity	1

### Product Compliance

[For compliance documentation, visit the product page on TE.com>](#)







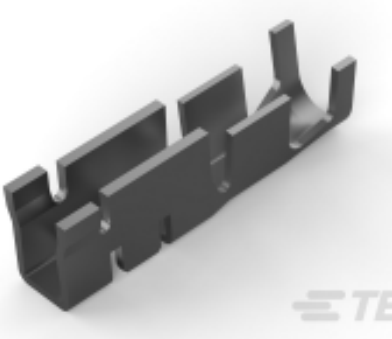
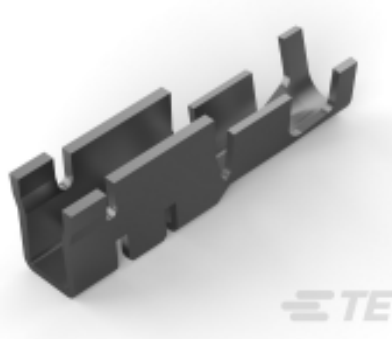
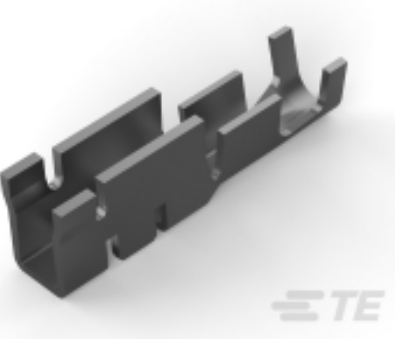
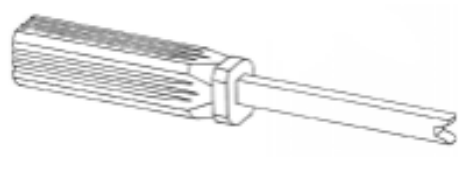

EU RoHS Directive 2011/65/EU	Compliant
EU ELV Directive 2000/53/EC	Compliant
China RoHS 2 Directive MIIT Order No 32, 2016	No Restricted Materials Above Threshold
EU REACH Regulation (EC) No. 1907/2006	Current ECHA Candidate List: JUNE 2024 (241) Candidate List Declared Against: JUNE 2024 (241) Does not contain REACH SVHC
Halogen Content	Low Halogen - Br, Cl, F, I < 900 ppm per homogenous material. Also BFR/CFR/PVC Free
Solder Process Capability	Not applicable for solder process capability

#### Product Compliance Disclaimer

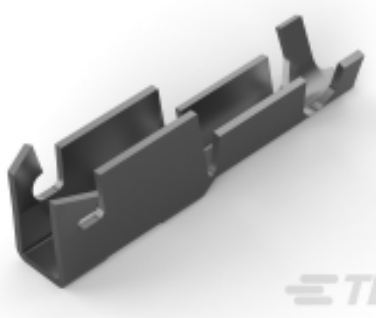
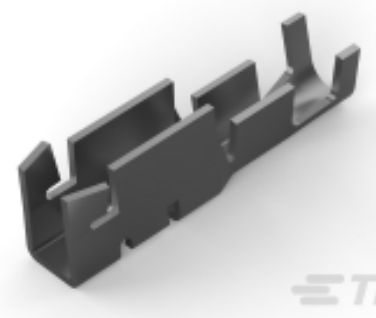
This information is provided based on reasonable inquiry of our suppliers and represents our current actual knowledge based on the information they provided. This information is subject to change. The part numbers that TE has identified as EU RoHS compliant have a maximum concentration of 0.1% by weight in homogenous materials for lead, hexavalent chromium, mercury, PBB, PBDE, DBP, BBP, DEHP, DIBP, and 0.01% for cadmium, or qualify for an exemption to these limits as defined in the Annexes of Directive 2011/65/EU (RoHS2). Finished electrical and electronic equipment products will be CE marked as required by Directive 2011/65/EU. Components may not be CE marked. Additionally, the part numbers that TE has identified as EU ELV compliant have a maximum concentration of 0.1% by weight in homogenous materials for lead, hexavalent chromium, and mercury, and 0.01% for cadmium, or qualify for an exemption to these limits as defined in the Annexes of Directive 2000/53/EC (ELV). Regarding the REACH Regulation, the information TE provides on SVHC in articles for this part number is based on the latest European Chemicals Agency (ECHA) 'Guidance on requirements for substances in articles' posted at this URL: <https://echa.europa.eu/guidance-documents/guidance-on-reach>

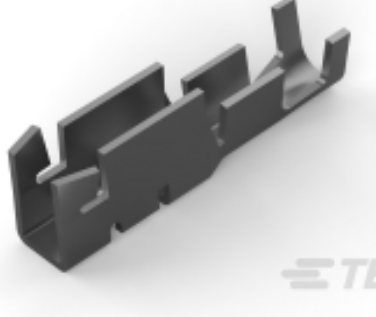
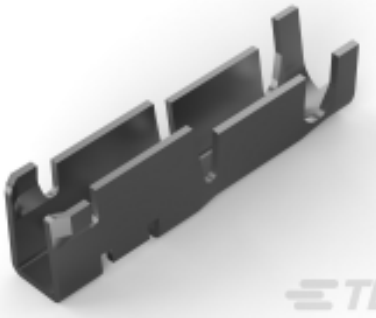
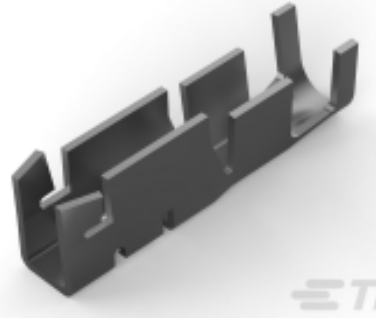
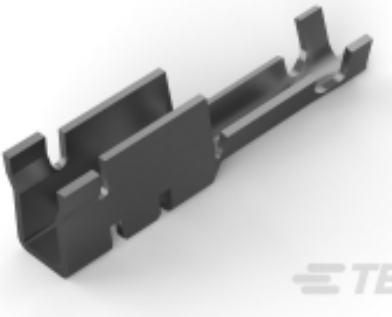
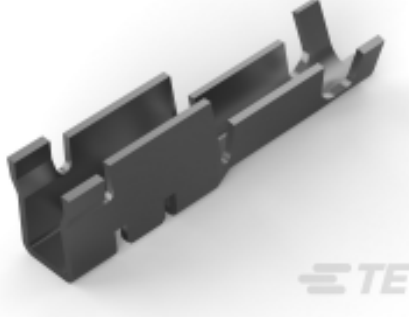
### Compatible Parts

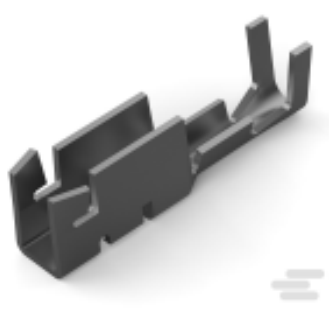

 <p>TE Part # 62243-3 125 PIN RECEPTACLE 14-10</p>	 <p>TE Part # 62244-3 125 PIN RCPT 18-16</p>	 <p>TE Part # 62244-6 125 PIN RECEPTACLE 18-16</p>	 <p>TE Part # 274186-1 EXTRACTION TOOL</p>
 <p>TE Part # 2825316-1 CLUSTER BLOCK HOUSING GWT</p>	 <p>TE Part # 62243-5 125 PIN RECEPTACLE 14-10</p>	 <p>TE Part # 1217671-1 CLSTR BLK RCPT AMVAR 1500-4200</p>	 <p>TE Part # 1217176-5 CLUSTER BLK RECP,18-16 020PHBR</p>
 <p>TE Part # 1217672-1 CLSTR BLK RCPT AMVAR 4000-8500</p>	 <p>TE Part # 1217176-1 CLUSTER BLOCK RECPT.</p>	 <p>TE Part # 63455-1 Cluster Block Recpt Amplivar 4000-8500</p>	 <p>TE Part # 1217175-1 CLUSTER BLOCK RECPT.</p>
 <p>TE Part # 63453-1 Cluster Block Recpt Amplivar 400-1600</p>	 <p>TE Part # 63454-1 Cluster Block Recpt Amplivar 1500-4200</p>	 <p>TE Part # 1217172-1 Cluster Block Recpt Amplivar 400-1600</p>	 <p>TE Part # 1217173-1 Cluster Block Recpt Amplivar 4000-8500</p>
 <p>TE Part # 1217174-1 Cluster Block Recpt Amplivar 1500-4200</p>	 <p>TE Part # 1217670-1 CLSTR BLK RCPT AMVAR 400-1600</p>	 <p>TE Part # 1742657-1 CLUSTER BLOCK RECP 22-18 020TP</p>	

### Customers Also Bought

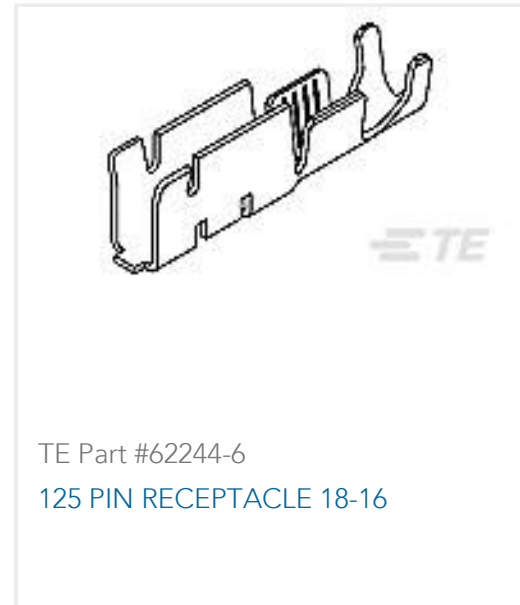
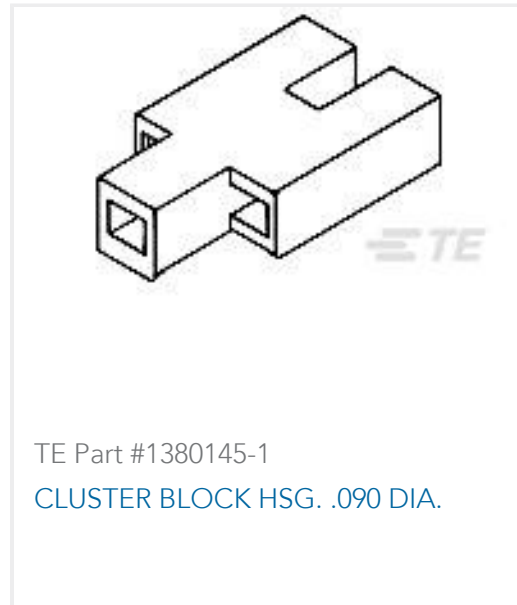
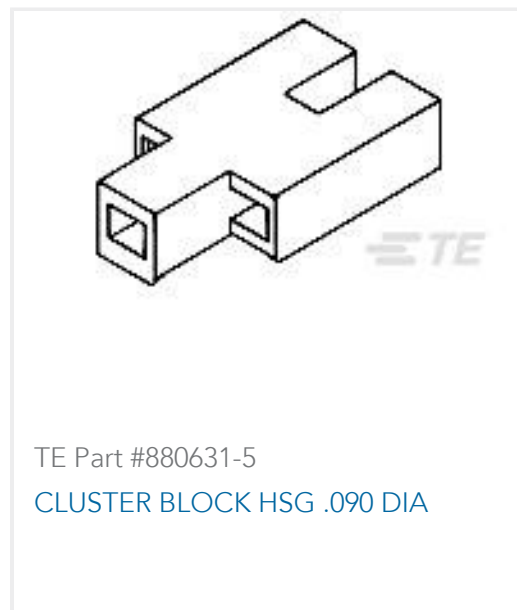

## Documents

### Product Drawings

125 DIA CLSTR BLK

English

### CAD Files

Customer View Model

[ENG\\_CVM\\_CVM\\_360052-1\\_AK.2d\\_dxf.zip](#)

English

### 3D PDF

3D

Customer View Model

[ENG\\_CVM\\_CVM\\_360052-1\\_AK.3d\\_igs.zip](#)

English

Customer View Model

[ENG\\_CVM\\_CVM\\_360052-1\\_AK.3d\\_stp.zip](#)

English

By downloading the CAD file I accept and agree to the [Terms and Conditions](#) of use.

## Datasheets & Catalog Pages



### Magnet Wire Terminals & Splices

English

---

### Product Specifications

#### Engineering Report

English

---

### Agency Approvals

#### Agency Approval Document

English