



TAOGLAS®



Datasheet

Barracuda

Part No:
OMB.6960.B07F21

Description:

600MHz - 8GHz Wideband 5G/4G/Wi-Fi (including Wi-Fi 6) Omnidirectional 7dBi Wall/Pole Mount Antenna with N-Type Female Connector

Features:

- Covers all 5G sub 6GHz and 4G LTE bands, 600MHz-8GHz
- Also covers Wi-Fi Including Wi-Fi 6/Extended Wi-Fi Frequencies
- High efficiency, omnidirectional coverage
- Up to 7dBi Peak Gain
- IP67 Rated Enclosure
- Wind resistant up to 200km/h
- Connector: N-Type Female
- Radome Dimensions: $\varnothing 26 \times 300\text{mm}$
- Bracket Dimensions: 60 x 40 x 65mm
- RoHS & Reach Compliant

1. Introduction	3
2. Specifications	4
3. Antenna Characteristics	6
4. Radiation Patterns	8
5. Mechanical Drawing	19
6. Installation Recommendations	20
7. Packaging	21
<hr/>	
Changelog	22

Taoglas makes no warranties based on the accuracy or completeness of the contents of this document and reserves the right to make changes to specifications and product descriptions at any time without notice. Taoglas reserves all rights to this document and the information contained herein. Reproduction, use or disclosure to third parties without express permission is strictly prohibited.



1. Introduction



The Taoglas Barracuda **OMB.6960.B07F21** is a 5G/4G outdoor antenna, operating between 600MHz and 8GHz, covering all worldwide sub 6GHz 5G and 4G LTE bands and also the above 6GHz Extended Wi-Fi/Wi-Fi 6 Frequencies. The OMB.6960 has excellent efficiency and gain at the 3.4-4.2GHz bands used for both C-band and CBRS frequency applications.

With up to 7 dBi peak gain, the collinear dipole array antenna provides omnidirectional coverage with great efficiency. The omnidirectional radiation pattern is uniform in the azimuth providing long distance coverage, thus minimizing the number of nodes needed for a radio network.

Typical Applications Include:

- Remote Monitoring
- Security
- Public Safety

The UV resistant, IP67 rated fiberglass housing enables this OMB series antenna to be used in harsh environments, making it more robust, vandal resistant and safer than traditional whip antennas. With a compact overall dimension of 340mm in height and 70mm wide, an integrated bracket allows it to be mounted conveniently and unobtrusively on a wall or pole. Connectivity is made via the rugged, industry standard, N-Type Female connector.

Covering all worldwide sub 6GHz 5G and LTE bands, the OMB.6960 it is perfect for setting up cellular mesh networks and suitable applications including remote asset monitoring and connected enterprise solutions. For further information or customized solutions, contact your regional Taoglas customer support team.

2. Specifications

Electrical

Band	Frequency (MHz)	Efficiency (%)	Average Gain (dB)	Peak Gain (dBi)	Impedance	Return Loss (dB)	Polarization	Radiation Pattern	Max Input Power
5G NR/4G Band 71	617~698	64.6	-2	2.2	50 Ω	<-10	Linear	Omni	150W
4G/3G Band 12,13,14,17,28,29	698~824	58.4	-2.4	1.6					
4G/3G Band 5,8,18,19,20,26,27	824~960	62.6	-2.1	3.1					
5G NR/4G Band 21,32,74,75,76	1427~1518	67	-1.8	3.3					
4G/3G Band 1,2,3,4,9,23,25,35,39,66	1710~2200	80.3	-1	4.1					
4G/3G Band 7,30,38,40,41	2300~2690	72	-1.5	4.3					
5G NR/4G Band 22,42,48,77,78,79	3300~5000	85	-0.7	5.9					
LTE5200/ Wi-Fi 5800	5150~5925	73.5	-1.4	7					
Wi-Fi 6	5925~7125	73.6	-1.2	8.3					

*measured in free space

Mechanical

Dimensions	300(L) x 60(W) x 400(H)mm
Radome Diameter	∅26
Connector	N-Type, Female
Antenna Weight	300g
Mounting Accessories Weight	40g
Radome Material	GFRP (White)
Bracket Material	Corrosion Resistant Aluminium
Wind Resistance	200 km/h
Wind Load @150Km/h	20N
Waterproof	IP67
Mounting	Pole Mount & Wall Mount

Environmental

Temperature Range	-40°C to 85°C
Humidity	Non-condensing 65°C 95% RH

5G/4G Bands			
Band Number	5GNR / FR1 / LTE / LTE-Advanced / WCDMA / HSPA / HSPA+ / TD-SCDMA		
	Uplink	Downlink	Covered
1	UL: 1920 to 1980	DL: 2110 to 2170	✓
2	UL: 1850 to 1910	DL: 1930 to 1990	✓
3	UL: 1710 to 1785	DL: 1805 to 1880	✓
4	UL: 1710 to 1755	DL: 2110 to 2155	✓
5	UL: 824 to 849	DL: 869 to 894	✓
7	UL: 2500 to 2570	DL: 2620 to 2690	✓
8	UL: 880 to 915	DL: 925 to 960	✓
9	UL: 1749.9 to 1784.9	DL: 1844.9 to 1879.9	✓
11	UL: 1427.9 to 1447.9	DL: 1475.9 to 1495.9	✓
12	UL: 699 to 716	DL: 729 to 746	✓
13	UL: 777 to 787	DL: 746 to 756	✓
14	UL: 788 to 798	DL: 758 to 768	✓
17	UL: 704 to 716	DL: 734 to 746	✓
18	UL: 815 to 830	DL: 860 to 875	✓
19	UL: 830 to 845	DL: 875 to 890	✓
20	UL: 832 to 862	DL: 791 to 821	✓
21	UL: 1447.9 to 1462.9	DL: 1495.9 to 1510.9	✓
22	UL: 3410 to 3490	DL: 3510 to 3590	✓
23	UL: 2000 to 2020	DL: 2180 to 2200	✓
24	UL: 1625.5 to 1660.5	DL: 1525 to 1559	✓
25	UL: 1850 to 1915	DL: 1930 to 1995	✓
26	UL: 814 to 849	DL: 859 to 894	✓
27	UL: 807 to 824	DL: 852 to 869	✓
28	UL: 703 to 748	DL: 758 to 803	✓
29	UL: -	DL: 717 to 728	✓
30	UL: 2305 to 2315	DL: 2350 to 2360	✓
31	UL: 452.5 to 457.5	DL: 462.5 to 467.5	✗
32	UL: -	DL: 1452 – 1496	✓
35		1850 to 1910	✓
38		2570 to 2620	✓
39		1880 to 1920	✓
40		2300 to 2400	✓
41		2496 to 2690	✓
42		3400 to 3600	✓
43		3600 to 3800	✓
48		3550 to 3700	✓
66	UL: 1710-1780	DL: 2110-2200	✓
71		617 to 698	✓
74/75/76		1427 to 1518	✓
77		3300 to 4200	✓
78		3300 to 3800	✓
79		4400 to 5000	✓

3. Antenna Characteristics

3.1 Return Loss

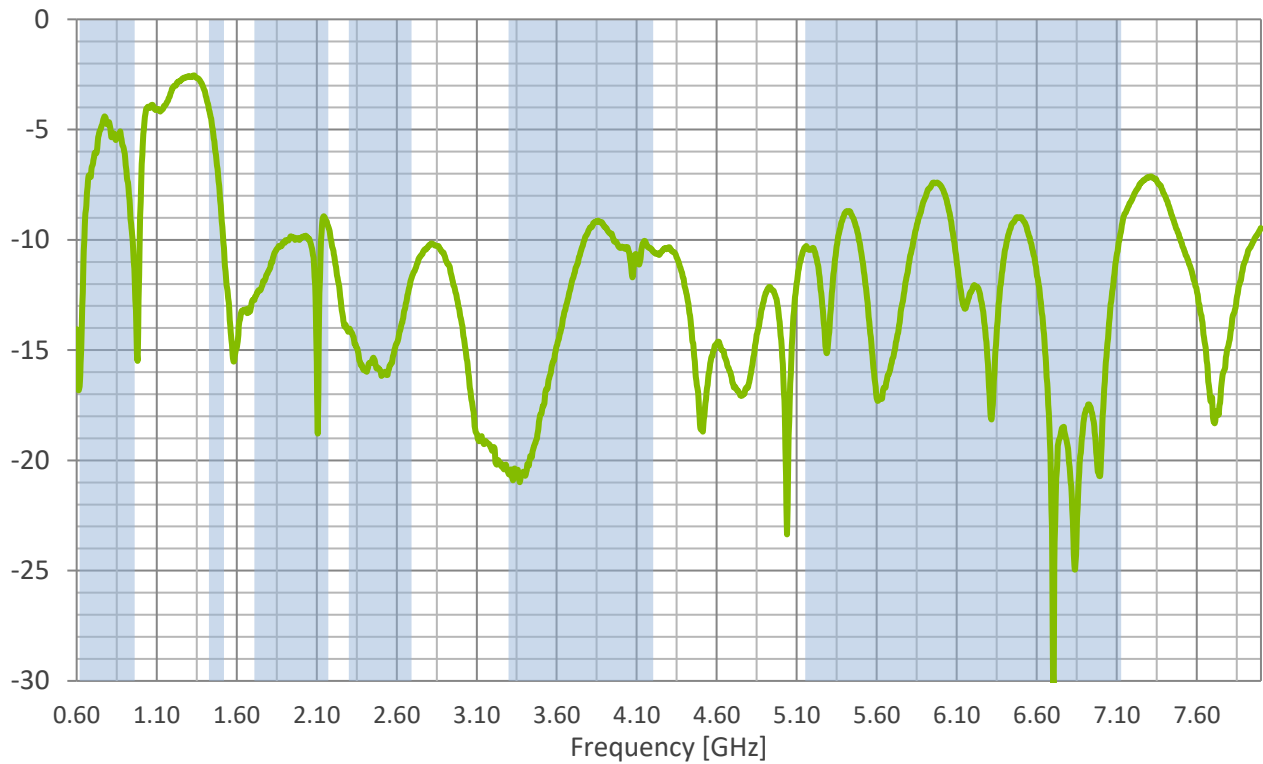

3.2 Efficiency

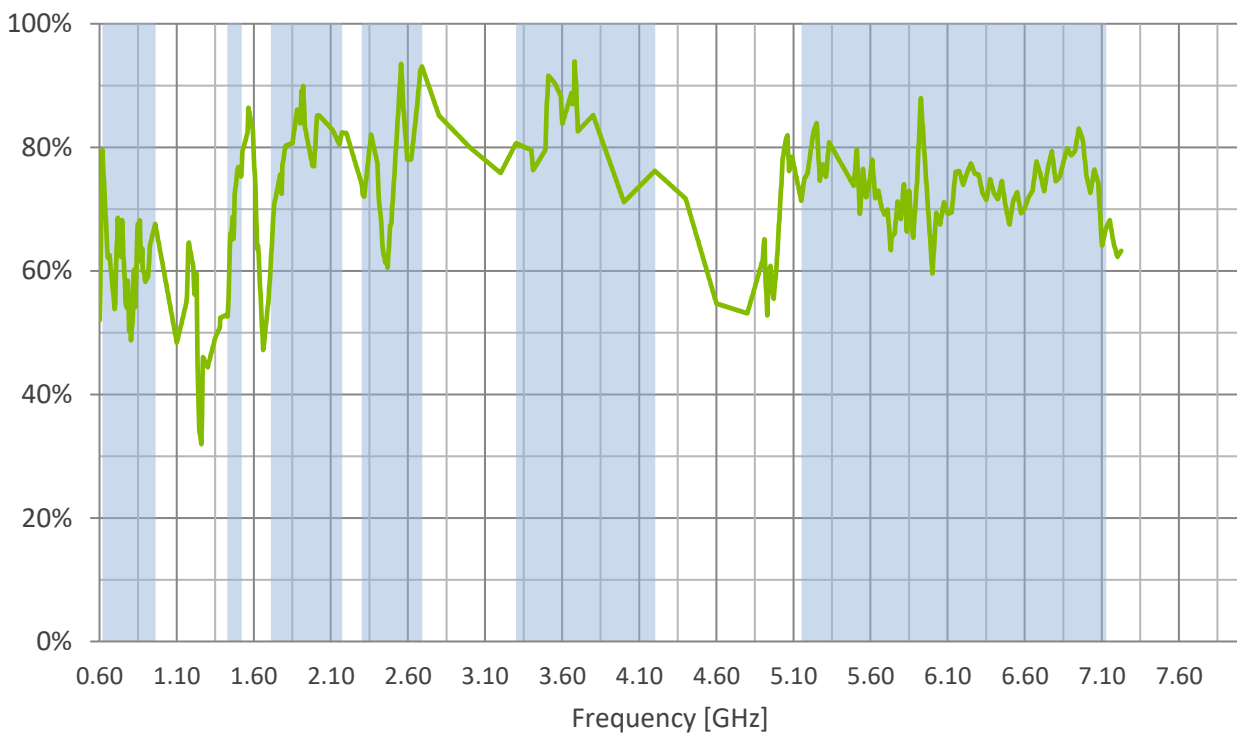

3.3 Average Gain

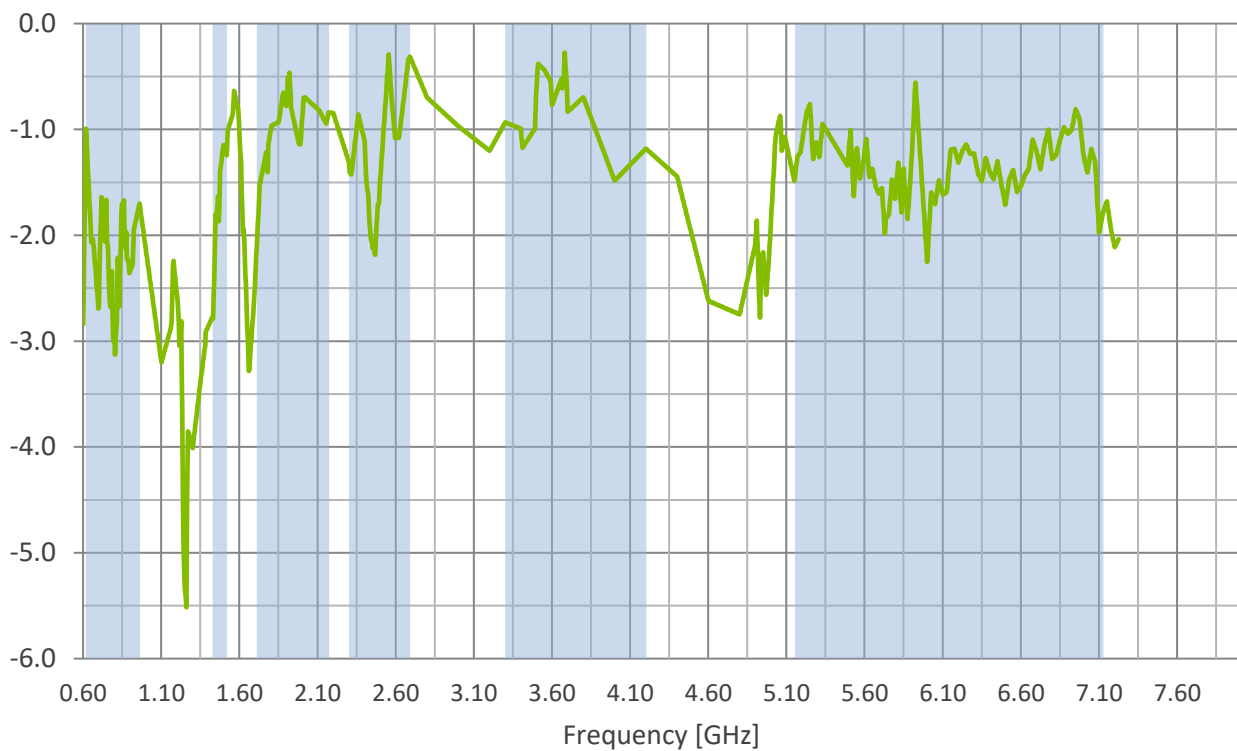

3.4 Peak Gain

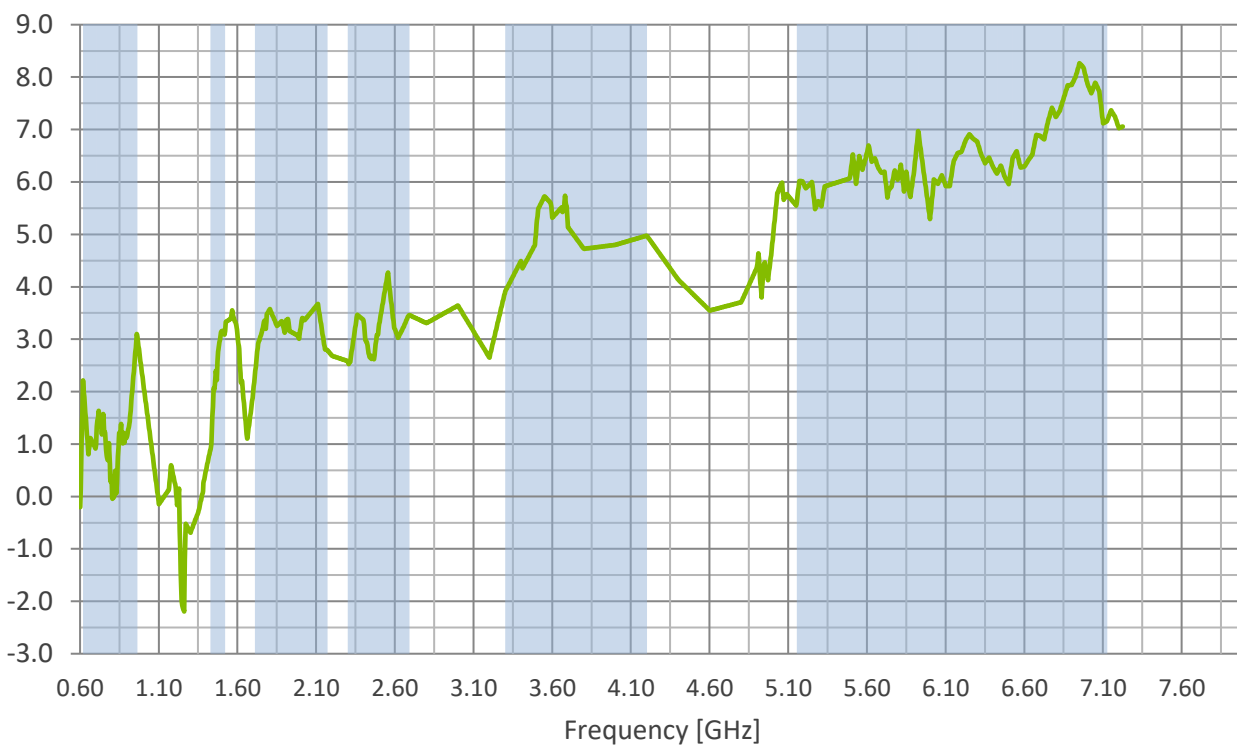

4. Radiation Patterns

4.1 Test Setup – Free Space



4.2 3D and 2D Radiation Patterns

652MHz

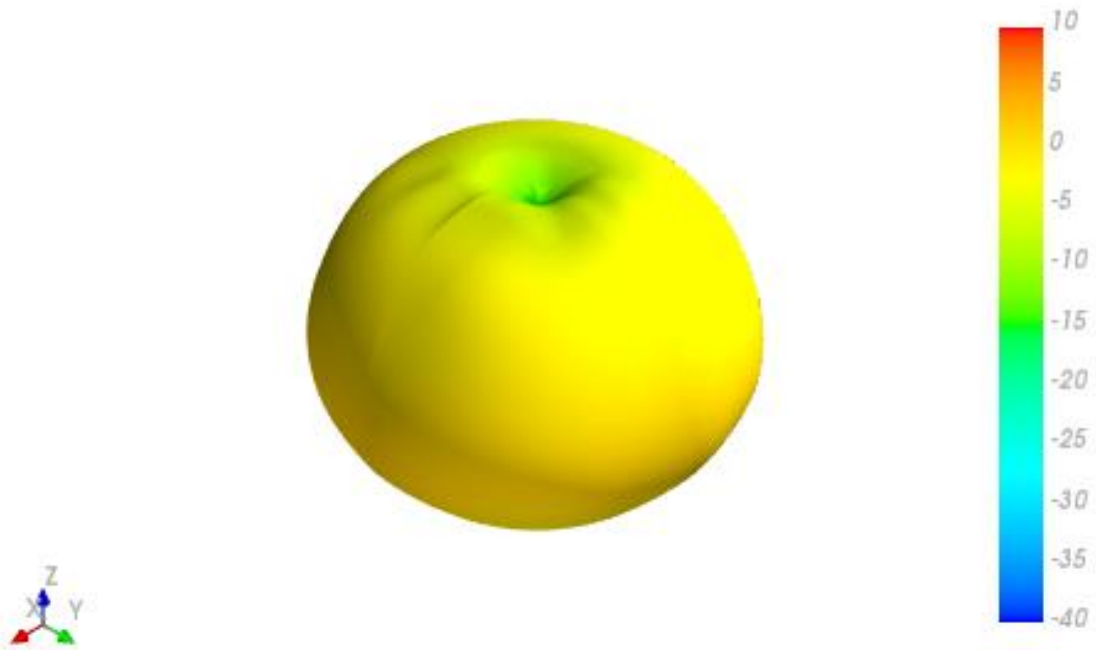

XY Plane

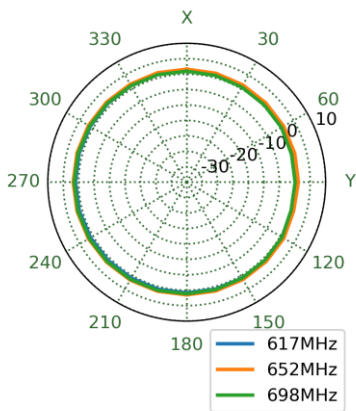

XZ Plane

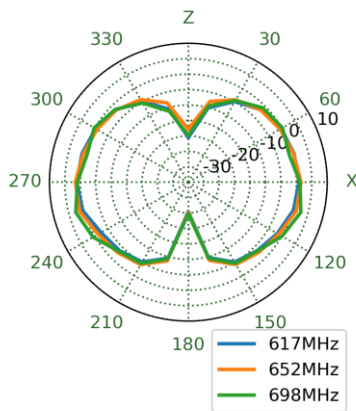

YZ Plane

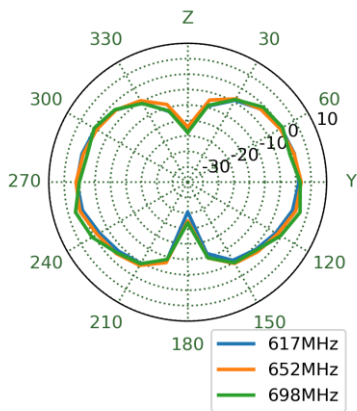

751MHz

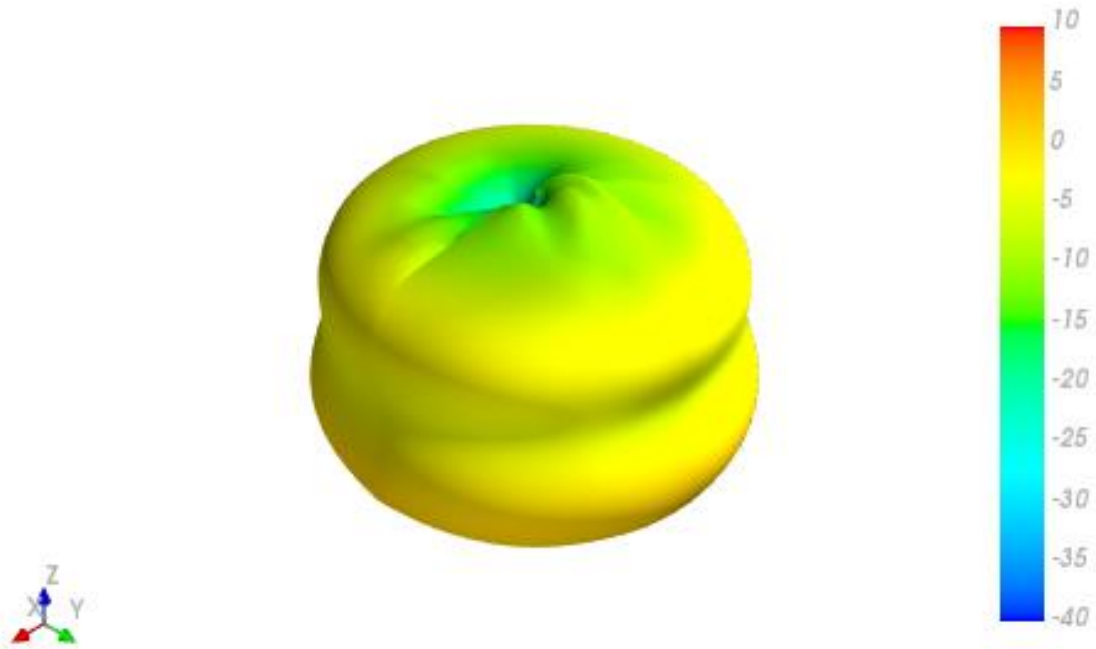

XY Plane

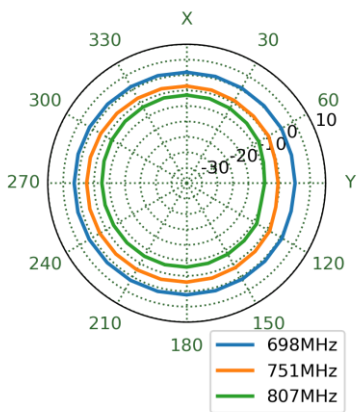

XZ Plane

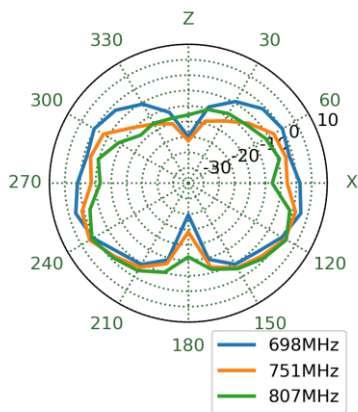

YZ Plane

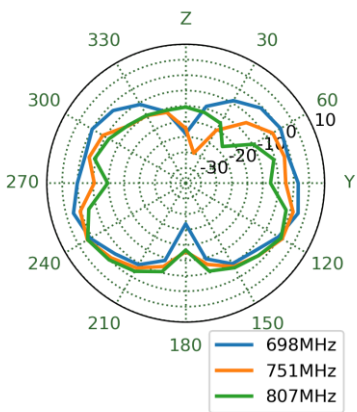

890MHz

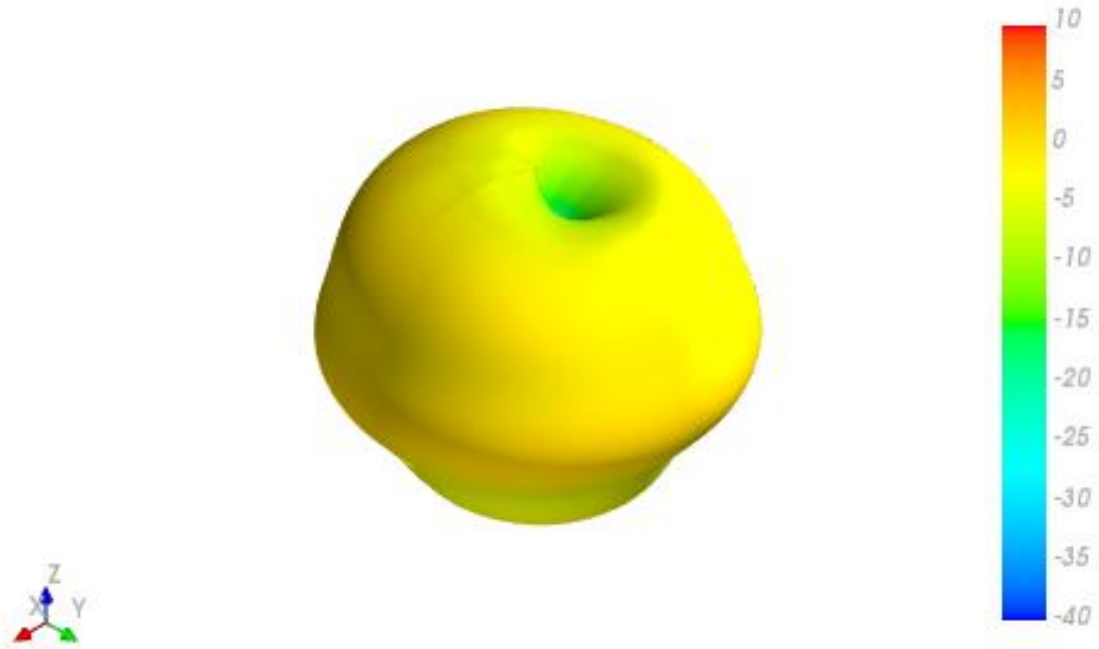

XY Plane

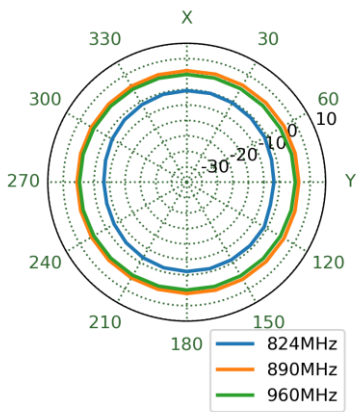

XZ Plane

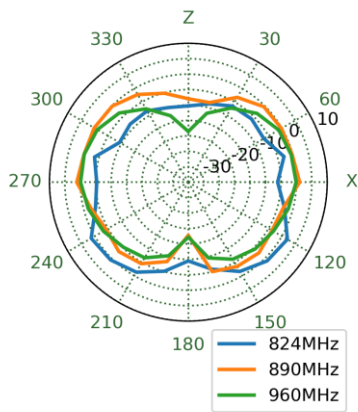

YZ Plane

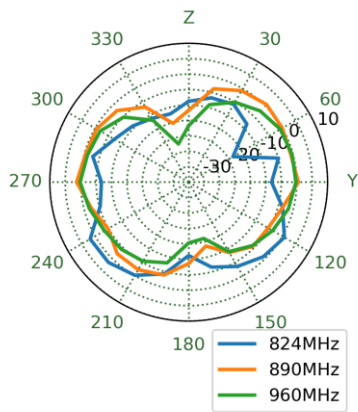

1470MHz

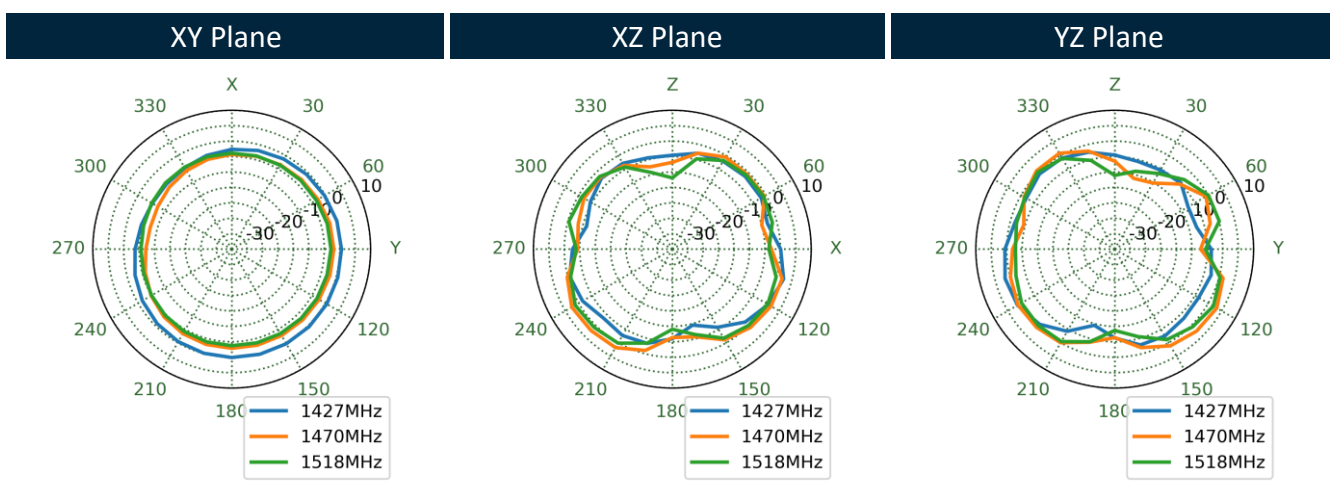
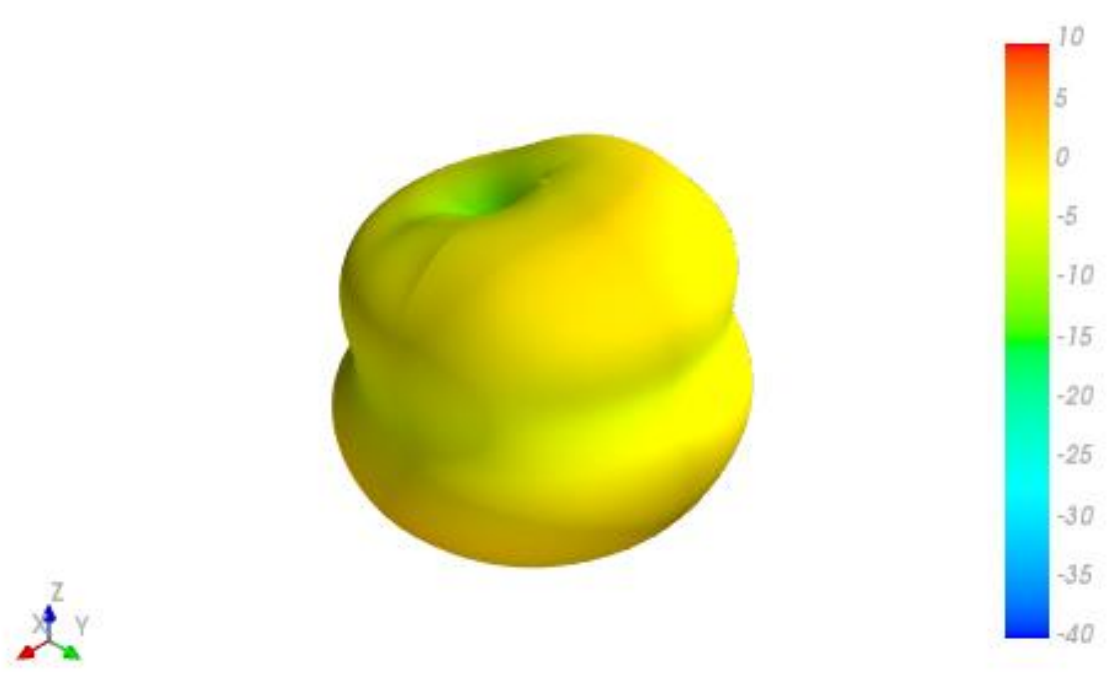

1805MHz

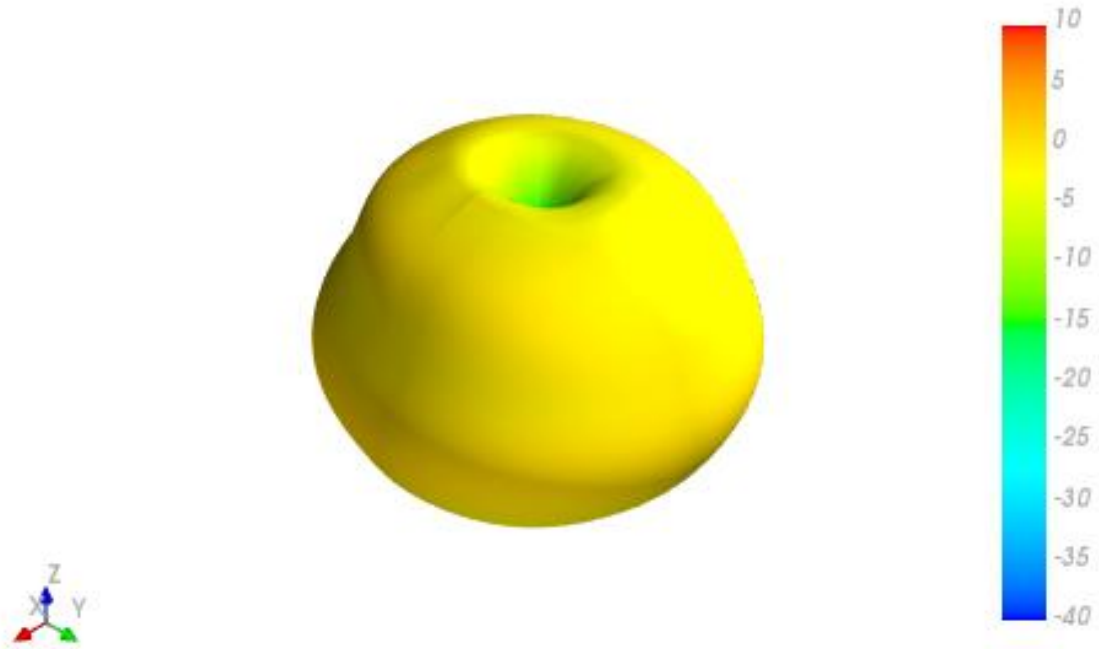

XY Plane

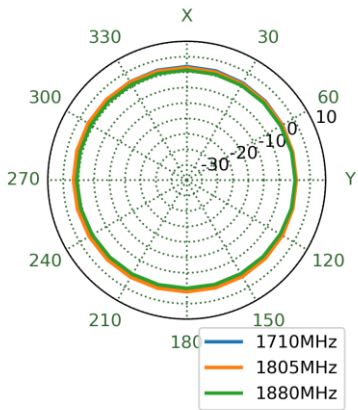

XZ Plane

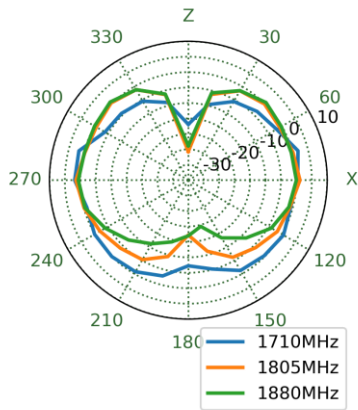

YZ Plane

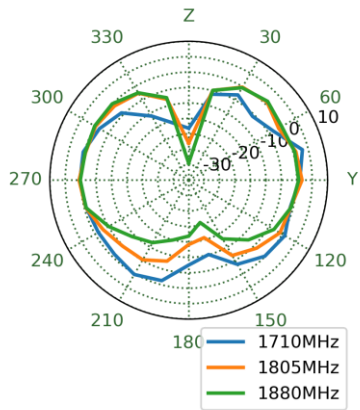

1920MHz

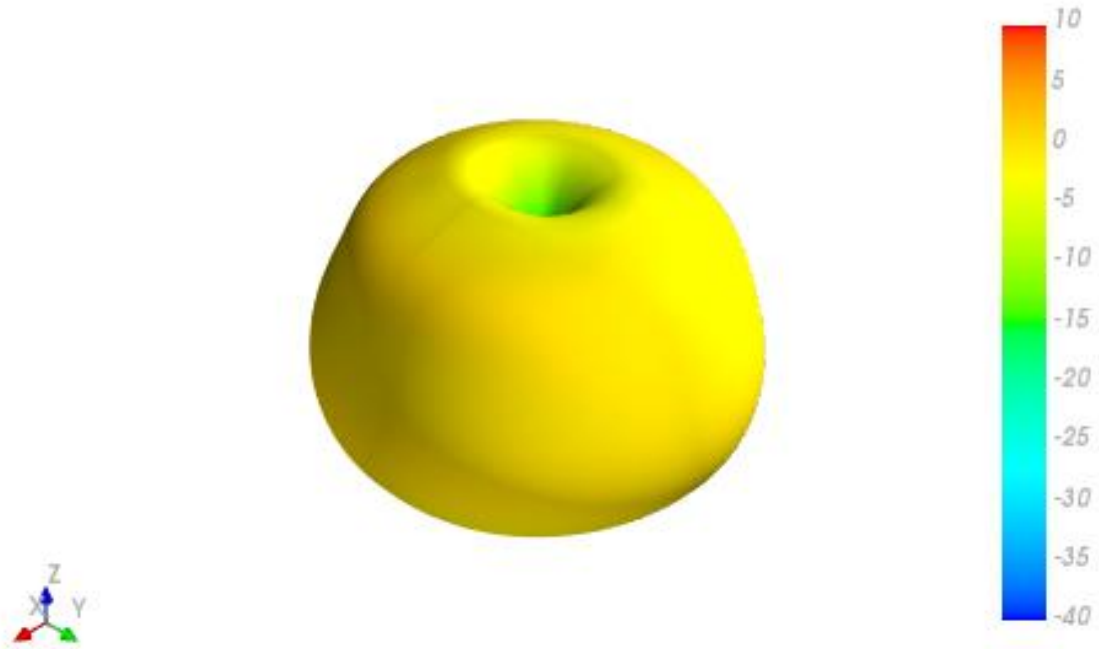

XY Plane

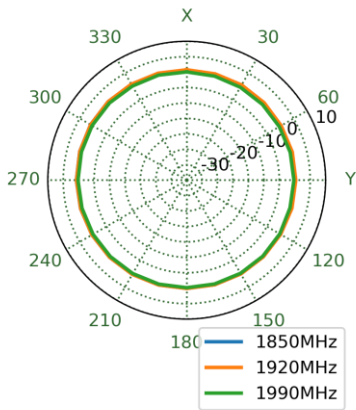

XZ Plane

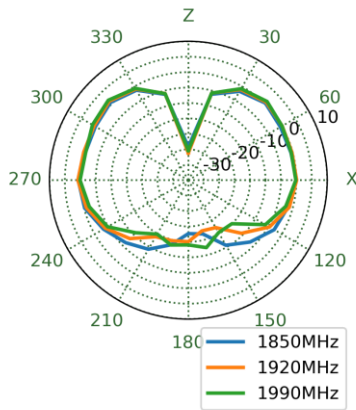

YZ Plane

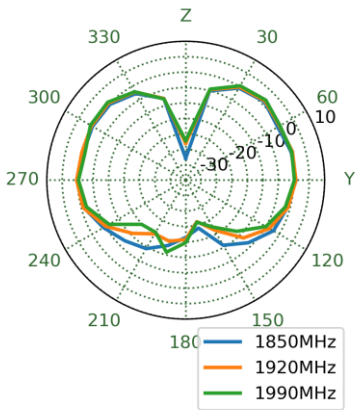

1990MHz

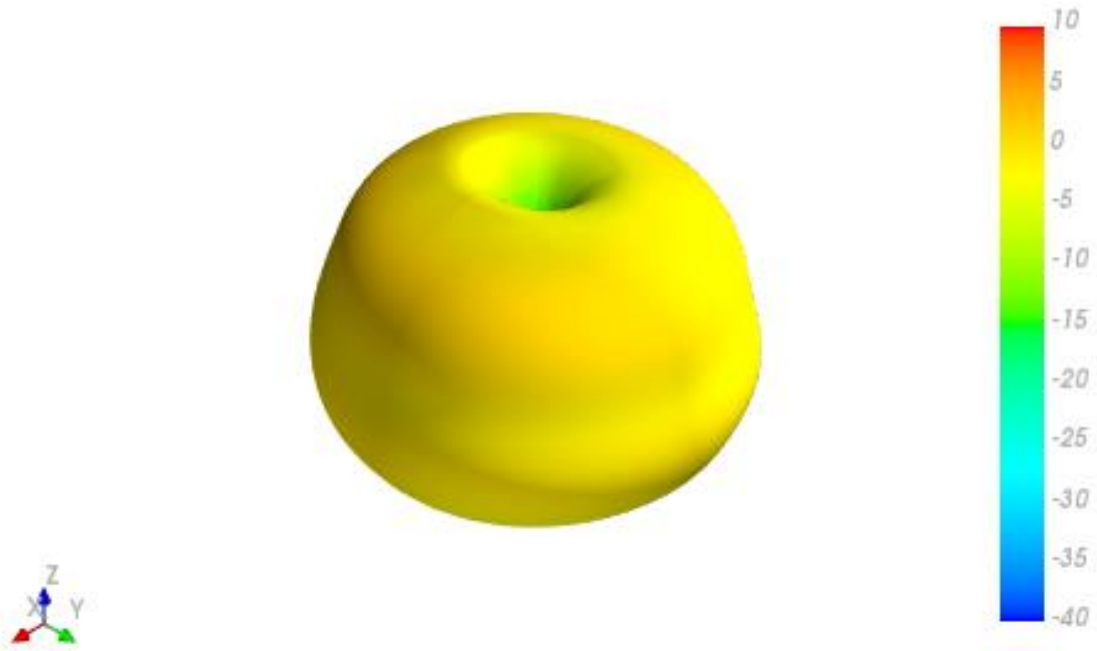

XY Plane

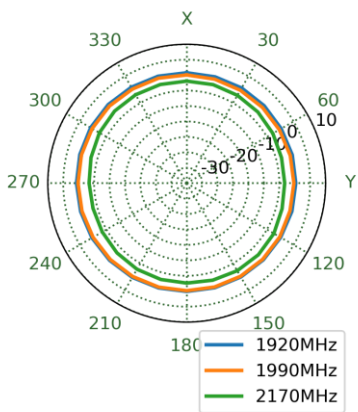

XZ Plane

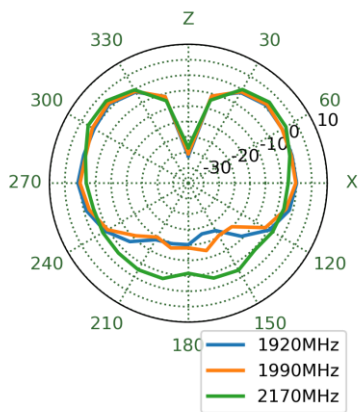

YZ Plane

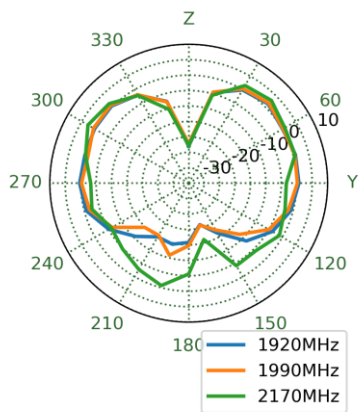

2595MHz

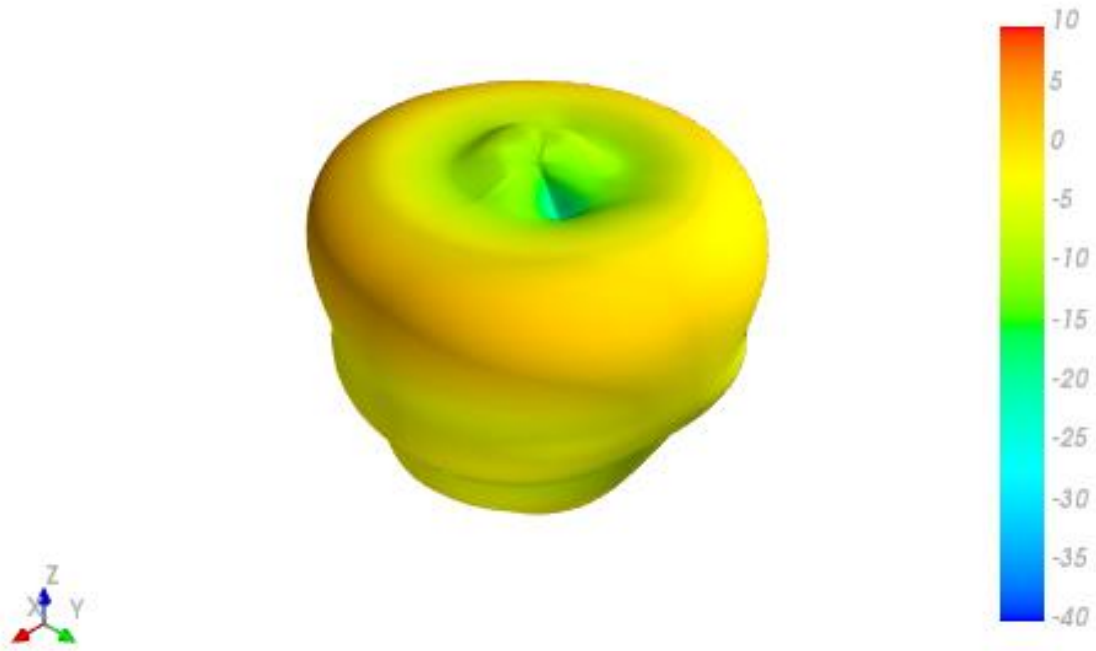

XY Plane

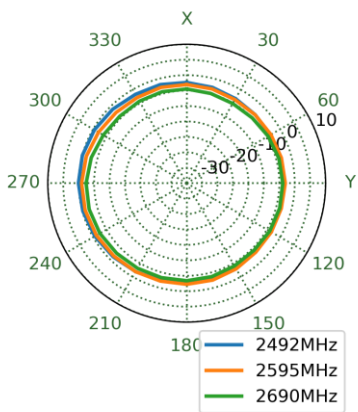

XZ Plane

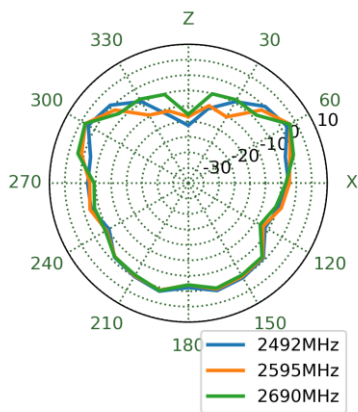

YZ Plane

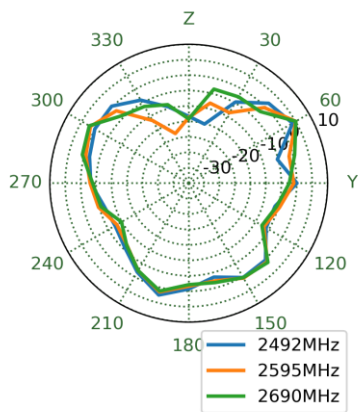

3550MHz

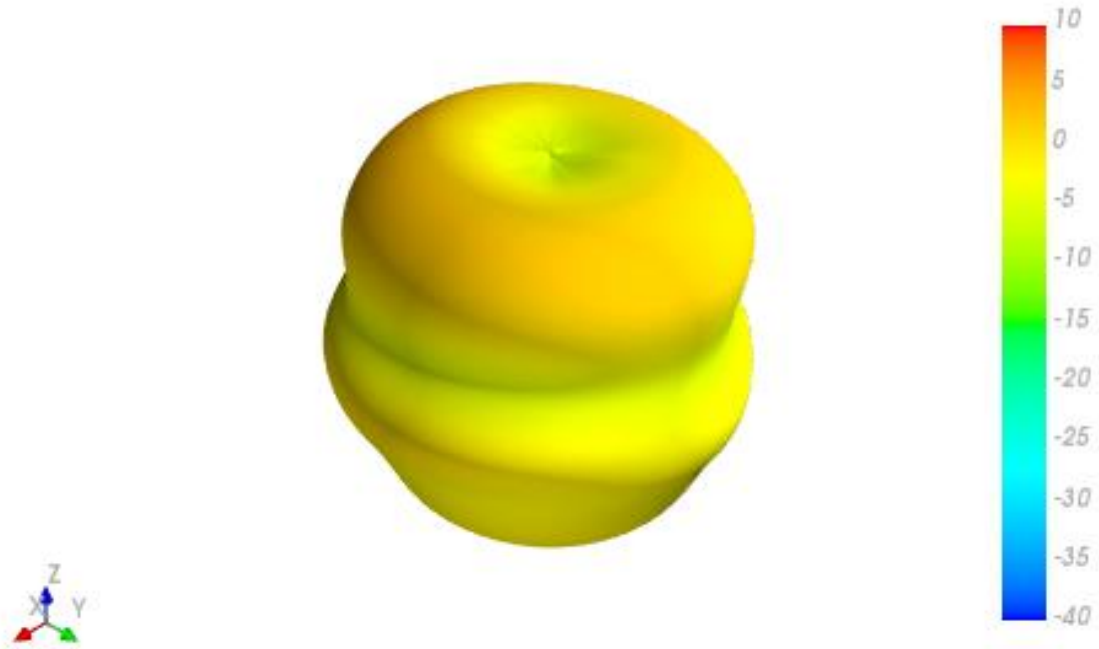

XY Plane

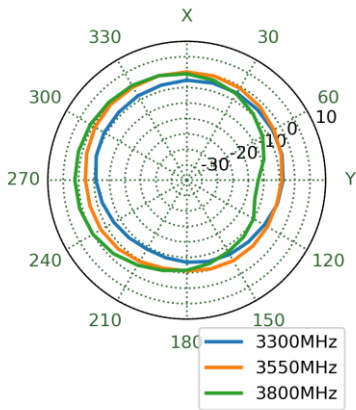

XZ Plane

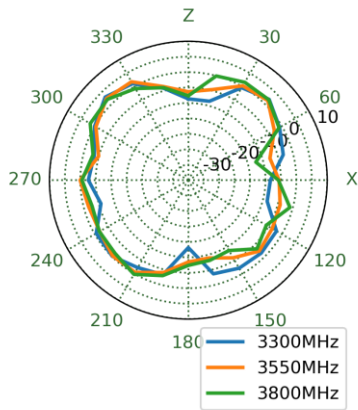

YZ Plane

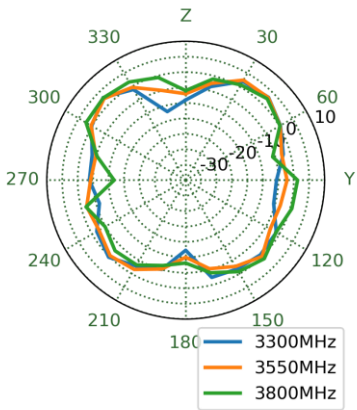

5530MHz

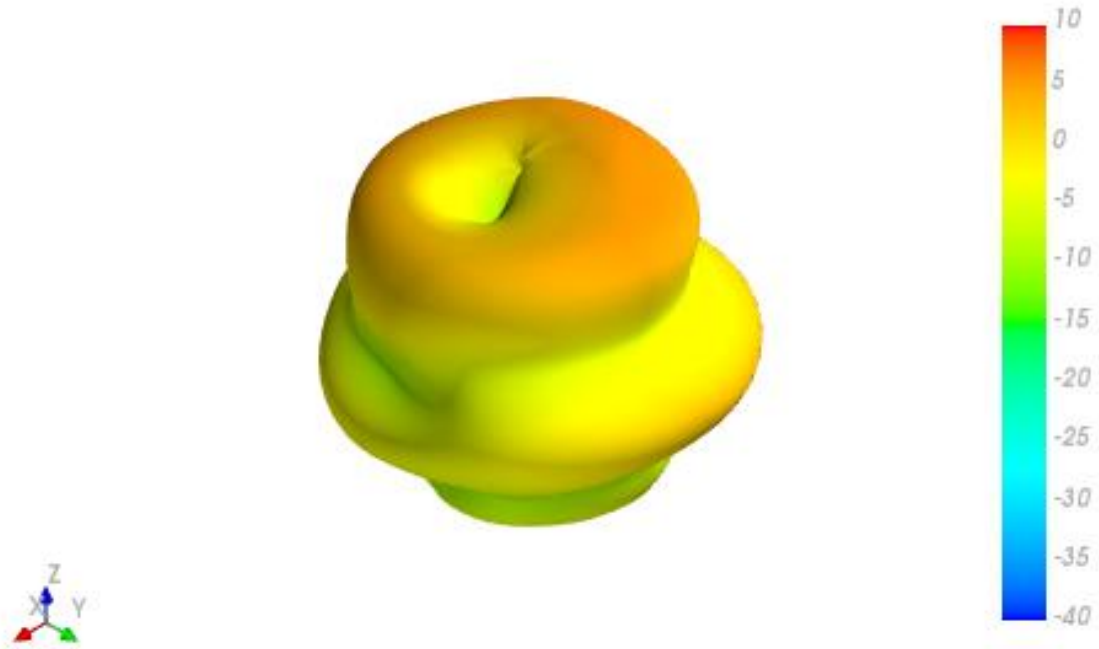

XY Plane

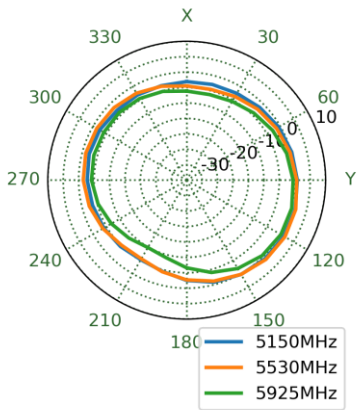

XZ Plane

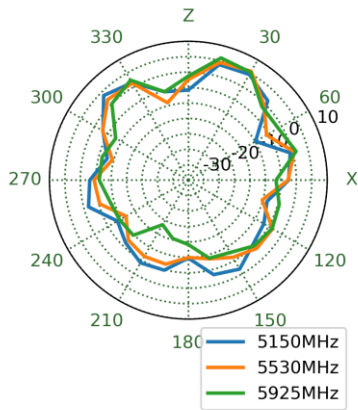

YZ Plane

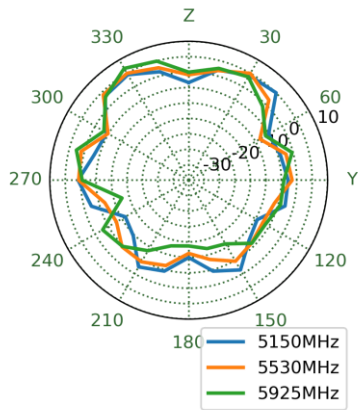

5. Mechanical Drawing (Units: mm)

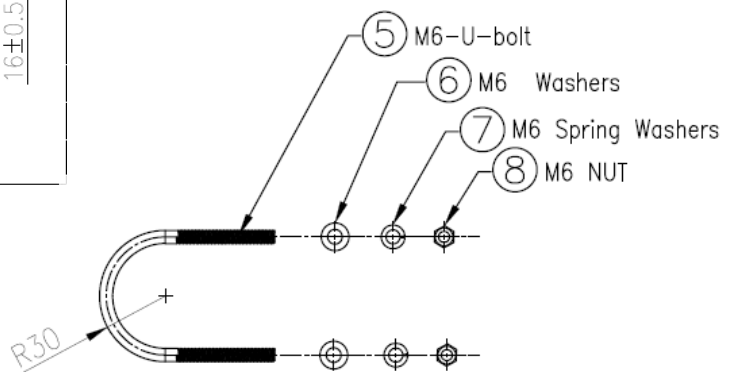
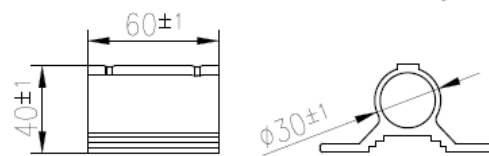
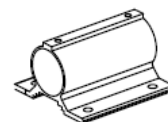
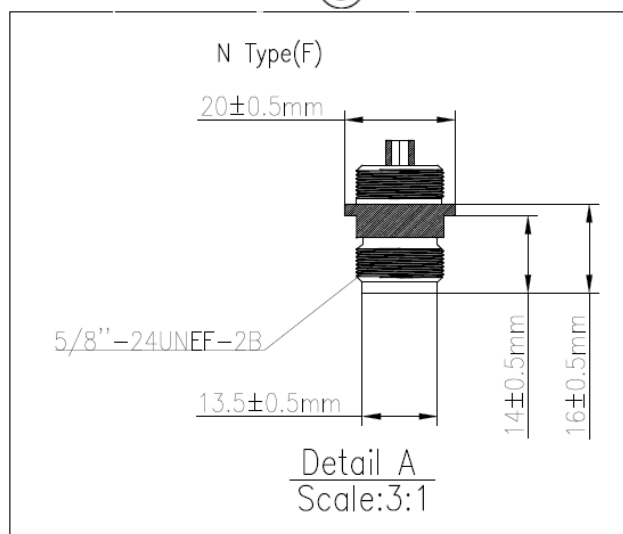
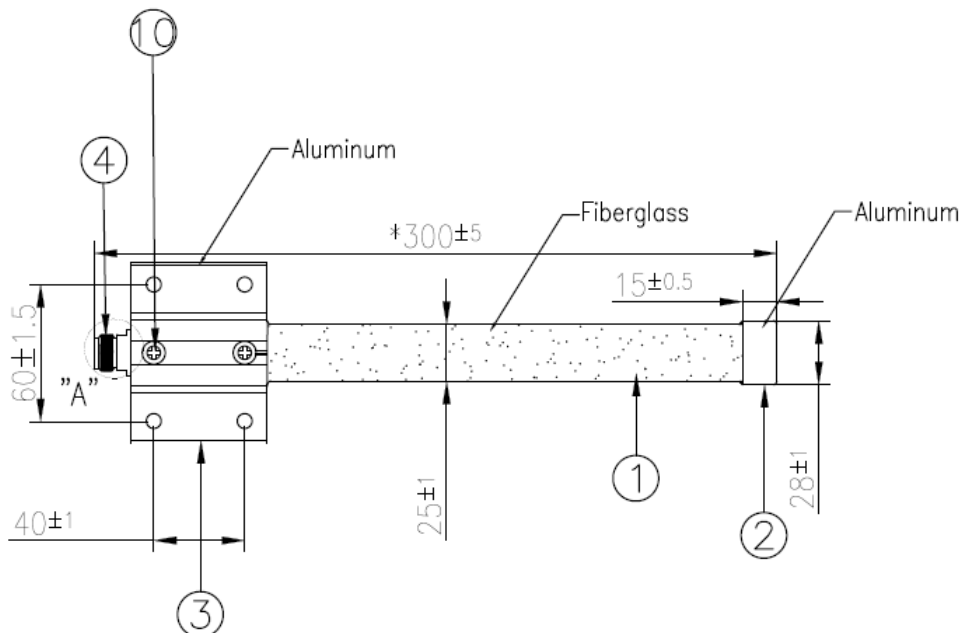

⑨ Label content

P/N: OMB.6960.B07F21
 Frequency: 600~6000MHz
 Peak Gain: 7dBi

	Name	Material	Finish	QTY
1	OMB.868 Antenna	Fiberglass	White	1
2	Cover	Aluminum	White	1
3	Bracket	Aluminum	Sliver	1
4	N Type(F)	Brass	Ni Plated	1
5	M6 U-bolt	Stainless Steel	Sliver	2
6	M6 Wahser	Stainless Steel	Sliver	4
7	M6 Spring Wahser	Stainless Steel	Sliver	4
8	M6 Nut	Stainless Steel	Sliver	4
9	Label	Coated paper	White	1
10	M5*11 Screw	SUS304	Sliver	2

6. Installation Recommendations

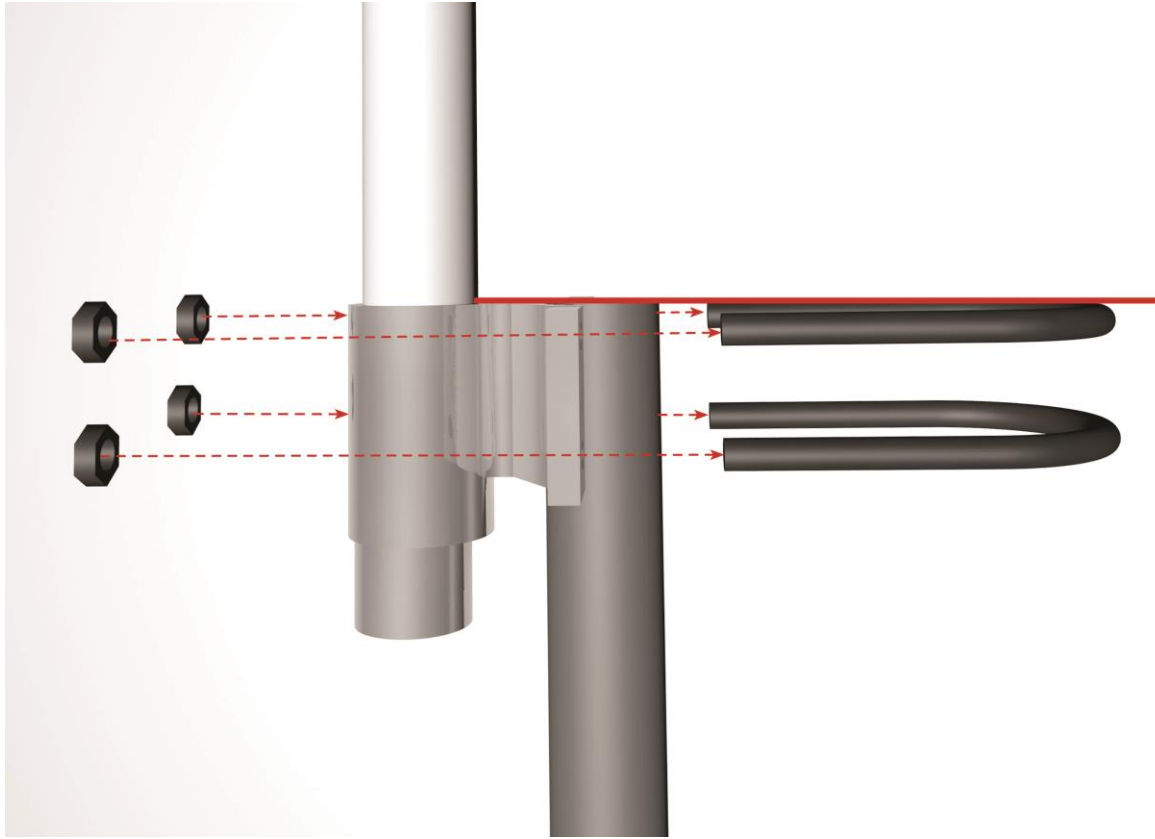

Pole Mounting

For optimum performance when mounting the antenna on a metal pole, please ensure that the base of the antenna is mounted above the top of the pole. Failure to do so may impede performance.

7. Packaging

1pcs OMB.6960.B07F21 per Tube
 Dimensions – Ø80*400
 Weight - 400g

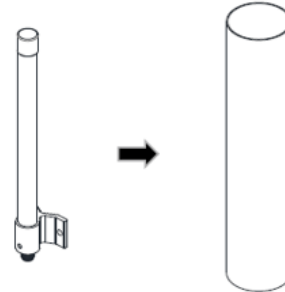

10pcs OMB.6960.B07F21 per carton
 Dimensions - 410*410*175mm
 Weight – 4.4Kg

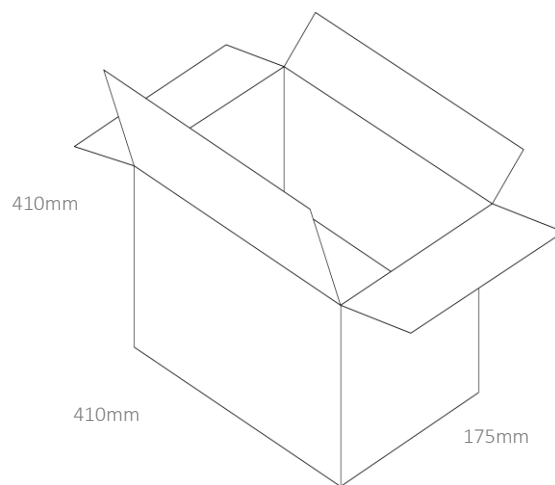

Pallet Dimensions:
 1000*1230*1365mm
 42 Cartons Per Pallet
 6 Cartons Per Layer
 7 Layers

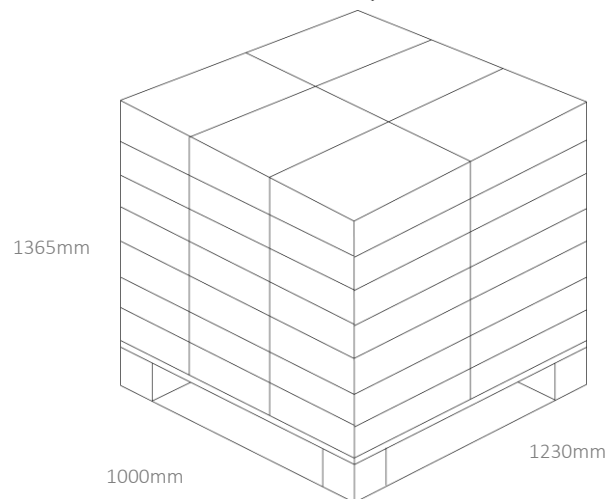

Changelog for the datasheet

SPE-21-8-123 - OMB.6960.B07F21

Revision: A (Original First Release)

Date:	2020-10-28
Notes:	Initial Release
Author:	Jack Conroy

Previous Revisions



TAOGLAS®

www.taoglas.com

