



# TAOGLAS®



# Datasheet

## Pantheon MA700.W 3-in-1 Permanent Mount Antenna

**Part No:**  
MA700.W.A.ABC.001

**Description:**

Pantheon MA700.W 3-in-1 Permanent Mount Antenna  
5G/4G, GNSS, 2.4/5.8Hz

**Features:**

- 2 x 5G/4G 600-6000MHz Antennas (MIMO)
- 1 x GPS/GLONASS/Galileo 1575.42/1602MHz Active Antenna
- 2 x Wi-Fi 2.4GHz/5.8GHz Antennas (MIMO)
- IP67 Waterproof
- Front End SAW Filter
- High Efficiency / Peak Gain Outdoor Antenna
- Dimensions: Ø143.2 x 82.4mm
- Fully Customizable Cable and Connectors
- RoHs & Reach Compliant

1. Introduction	3
2. Specifications	4
3. Antenna Characteristics	8
4. Radiation Patterns	16
5. Mechanical Drawing	38
6. Installation	39
7. Packaging	40
<hr/>	
Changelog	41

Taoglas makes no warranties based on the accuracy or completeness of the contents of this document and reserves the right to make changes to specifications and product descriptions at any time without notice. Taoglas reserves all rights to this document and the information contained herein. Reproduction, use or disclosure to third parties without express permission is strictly prohibited.



# 1. Introduction



The Taoglas MA05.W0 Pantheon 3-in-1 antenna is an omnidirectional heavy-duty, fully IP67 waterproof external M2M antenna for use in telematics, transportation, and remote monitoring applications. This unique antenna delivers powerful antenna technology for 5G/4G Cellular and Wi-Fi, plus GNSS for next-generation multiple wireless technology systems. The GNSS antenna covers the GPS/GLONASS/Galileo bands and includes a Front End SAW Filter for improved performance.

The Pantheon MA700.W covers all 5G bands from 600-6000MHz, exhibiting excellent performance at key 5G bands such as band 71(617MHz) and the repurposed CBRS and C-band frequencies from 3400-4200MHz. This ensures the Pantheon is prepared for mission critical applications.

Typical Applications Include:

- Public Safety
- Passenger Bus and Rail Services
- Digital Signage
- Commercial Transportation and Fleet Management

All five high-performance antennas are integrated into an extremely robust IP67 permanent mount compact antenna package measuring just 82.4mm in height and 143.2mm in diameter.

The antenna has its own ground-plane and can radiate on any mounting environment like metal or plastic without affecting performance. The cables are low loss allowing for lengths of up to 10 meters (32' and 9.70"), critical for buses, trains, and other commercial transport applications.

Customized cables and connector version available, contact your regional Taoglas customer support team for further information.

## 2. Specifications

GNSS Frequency Bands Covered							
GPS/QZSS	L1 1575.42MHz	L2 1227.6MHz	L5 1176.45MHz	L6 1278.75MHz			
	■	□	□	□			
GLONASS	L5R 1176.45MHz	L3PT 1201.5MHz	L2PT 1246MHz	L1CR 1575.42MHz	L1PT 1602MHz		
	□	□	□	□	■		
Galileo	E5a 1176.45MHz	E5b 1201.5MHz	E4 1215MHz	E3 1256MHz	E6 1278.75MHz	E2 1561MHz	E1 1575.42MHz
	□	□	□	□	□	□	■
BeiDou	B1 1561MHz	B2 1207.14MHz	B3 1268.52MHz				
	□	□	□				
Compass	E5B(B2)/ E6(B3) 1268.56MHz	E2(B1) 1561MHz					
	□	□					
SBAS	Omnistar 1542.5MHz	WAAS/EGN OS 1575.42MHz					
	□	□					
GNSS Electrical							
Centre Frequency				1575.42MHz / 1602MHz			
Bandwidth				10MHz			
Radiation Efficiency				50(without cable)			
VSWR				2			
Impedance				50Ω			
DC Power Input Range				3 - 5V			
DC Input	3.3V		4.0V		5.5V		
Frequency	1575.42	1602	1575.42	1602	1575.42	1602	
VSWR	2	2	2	2	2	2	
LNA Gain	29.2	29	31	31	32.3	32	
Noise Figure	3.1	3.1	3.2	3.2	3.4	3.4	
Power Consumption	7.5	7.5	9.4	9.4	15	15	
Band Attenuation	1520MHz: -20dB 1642MHz: -20dB		1520MHz: -20dB 1642MHz: -20dB		1520MHz: -20dB 1642MHz: -20dB		

5G/4G MIMO								
Band	Frequency (MHz)		Efficiency (%)	Average Gain (dB)	Peak Gain (dBi)	VSWR	Impedance	Polarization
5G NR/4G Band 5,8,12,13,14,17,18,20,26,27,28, 29,71	617~960	Free Space	61	-2.2	3.3	3 Max	50Ω	Linear
		30X30cm GroundPlane	35	-1.7	3.5			
5G NR/4G Band 21,32,74,75,76	1427~1518	Free Space	36	-4.4	2.8			
		30X30cm GroundPlane	21	-4.8	2.8			
4G/3G Band 1,2,3,4,9,23,25,35,39,66	1710~2200	Free Space	58	-2.4	3.1			
		30X30cm GroundPlane	48	-2.4	5.4			
Wi-Fi 2400		Free Space	44	-3.6	2.1			
		30X30cm GroundPlane	64	-3.2	4.0			
4G/3G Band 7,38,41	2490~2690	Free Space	51	-3.0	4.6			
		30X30cm GroundPlane	65	-2.6	4.7			
5G NR/4G Band 22,42,43,48,77,78,79	3300~5000	Free Space	34	-5.2	5.8			
		30X30cm GroundPlane	41	-5.1	8.1			
LTE5200/ Wi-Fi 5800	5150~5925	Free Space	16	-8.1	1.2			
		30X30cm GroundPlane	23	-8.2	2.4			

Wi-Fi MIMO 2.4GHz / 5GHz						
Frequency (MHz)	Efficiency (%)	Average Gain (dB)	Peak Gain (dBi)	VSWR	Polarization	Impedance
2400~2500	36	-4.5	3.7	2 Max	Linear	50 Ω
5150~5850	51	-2.9	5.4			

All measurements were conducted with 0.5m low loss CFD200 cable.

<b>Mechanical</b>	
Antenna Dimensions	Height 85.7mm x Diameter 145.6mm
Casing	Wonderloy PC-540 PC/ABS Alloy
Waterproof	IP67
Cables	5G/4G & Wi-Fi - 3M CFD-200 GNSS - 3M RG-174
Connectors	GNSS & 5G/4G – SMA(M) Wi-Fi – RP-SMA(M)
Base and thread	CAN10 Zinc Alloy
Thread diameter	M30 x 2 (30mm)
Nut	Nickel Plated Steel
Foam	3M 9448HK
Weight(kg)	1.29(Antenna)
Recommended Torque for Mounting	5-7Nm
<b>Enviornmental</b>	
Operation Temperature	-40°C to 85°C
Storage Temperature	-40°C to 90°C
Humidity	Non-condensing 65°C 95% RH

5G/4G Bands			
Band Number	5G NR / FR1 / LTE / LTE-Advanced / WCDMA / HSPA / HSPA+ / TD-SCDMA		
	Uplink	Downlink	Covered
1	UL: 1920 to 1980	DL: 2110 to 2170	✓
2	UL: 1850 to 1910	DL: 1930 to 1990	✓
3	UL: 1710 to 1785	DL: 1805 to 1880	✓
4	UL: 1710 to 1755	DL: 2110 to 2155	✓
5	UL: 824 to 849	DL: 869 to 894	✓
7	UL: 2500 to 2570	DL: 2620 to 2690	✓
8	UL: 880 to 915	DL: 925 to 960	✓
9	UL: 1749.9 to 1784.9	DL: 1844.9 to 1879.9	✓
11	UL: 1427.9 to 1447.9	DL: 1475.9 to 1495.9	✓
12	UL: 699 to 716	DL: 729 to 746	✓
13	UL: 777 to 787	DL: 746 to 756	✓
14	UL: 788 to 798	DL: 758 to 768	✓
17	UL: 704 to 716	DL: 734 to 746	✓
18	UL: 815 to 830	DL: 860 to 875	✓
19	UL: 830 to 845	DL: 875 to 890	✓
20	UL: 832 to 862	DL: 791 to 821	✓
21	UL: 1447.9 to 1462.9	DL: 1495.9 to 1510.9	✓
22	UL: 3410 to 3490	DL: 3510 to 3590	✓
23	UL: 2000 to 2020	DL: 2180 to 2200	✓
24	UL: 1625.5 to 1660.5	DL: 1525 to 1559	✓
25	UL: 1850 to 1915	DL: 1930 to 1995	✓
26	UL: 814 to 849	DL: 859 to 894	✓
27	UL: 807 to 824	DL: 852 to 869	✓
28	UL: 703 to 748	DL: 758 to 803	✓
29	UL: -	DL: 717 to 728	✓
30	UL: 2305 to 2315	DL: 2350 to 2360	✓
31	UL: 452.5 to 457.5	DL: 462.5 to 467.5	✗
32	UL: -	DL: 1452 - 1496	✓
35		1850 to 1910	✓
38		2570 to 2620	✓
39		1880 to 1920	✓
40		2300 to 2400	✓
41		2496 to 2690	✓
42		3400 to 3600	✓
43		3600 to 3800	✓
48		3550 to 3700	✓
66	UL: 1710-1780	DL: 2110-2200	✓
71		617 to 698	✓
74/75/76		1427 to 1518	✓
78		3300 to 3800	✓
79		4400 to 5000	✓
85	698-716	728-746	✓

### 3. Antenna Characteristics

#### 3.1 Return Loss

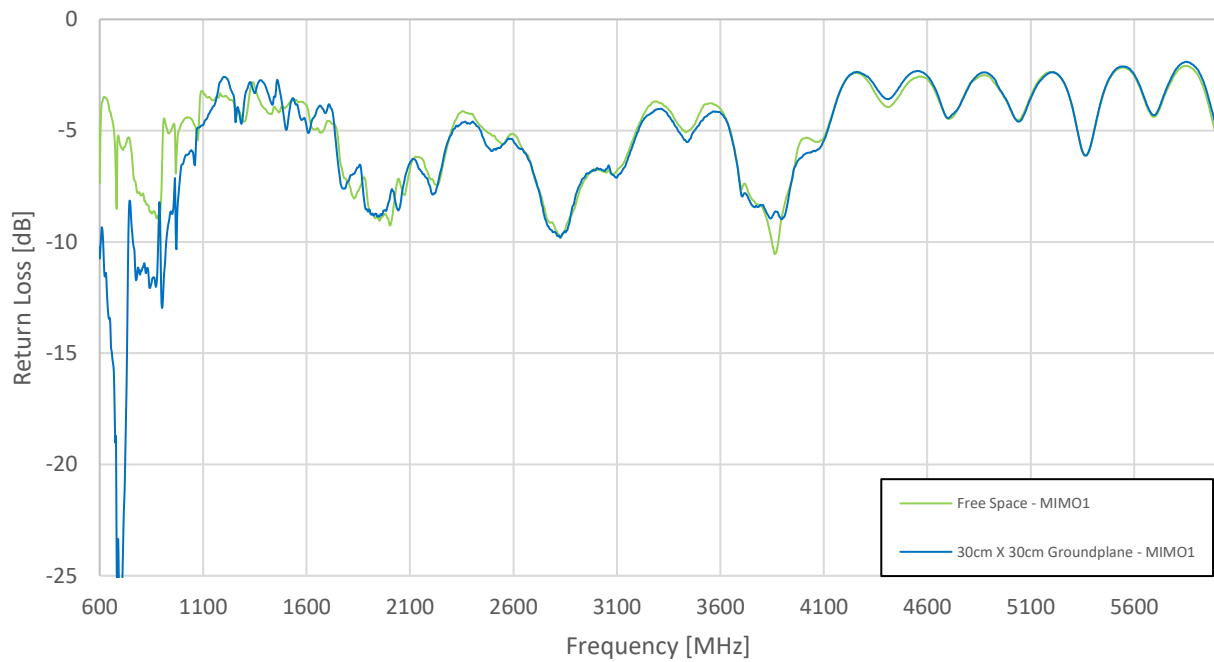

#### 3.2 Efficiency

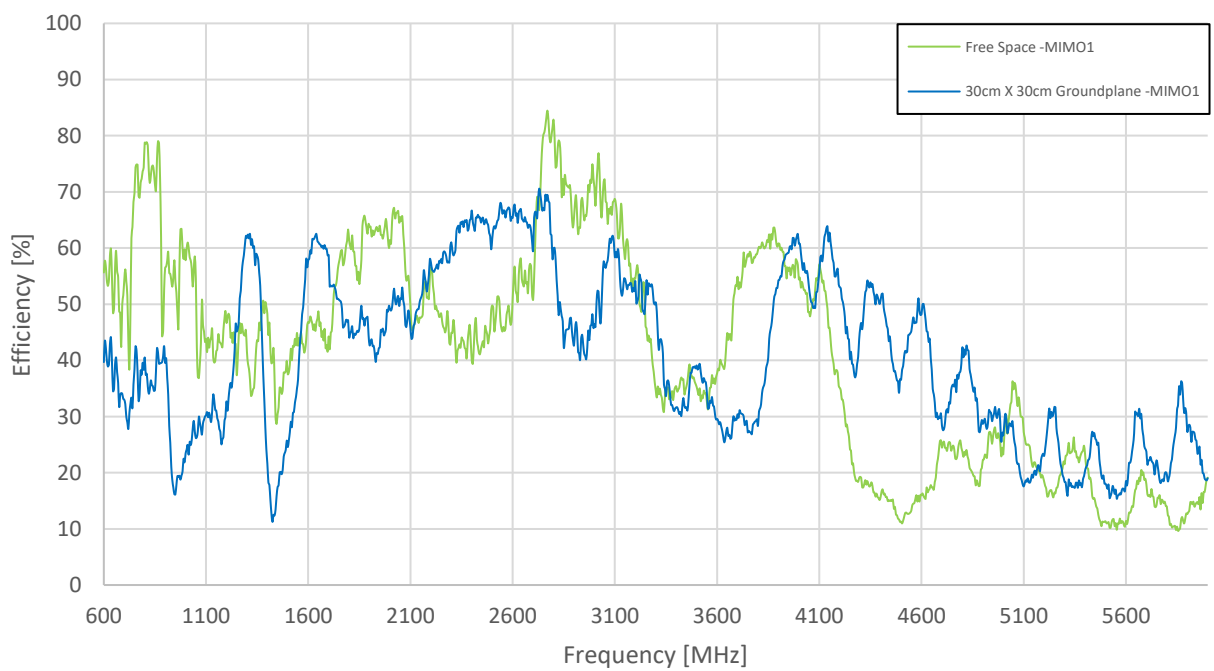

### 3.3 Peak Gain

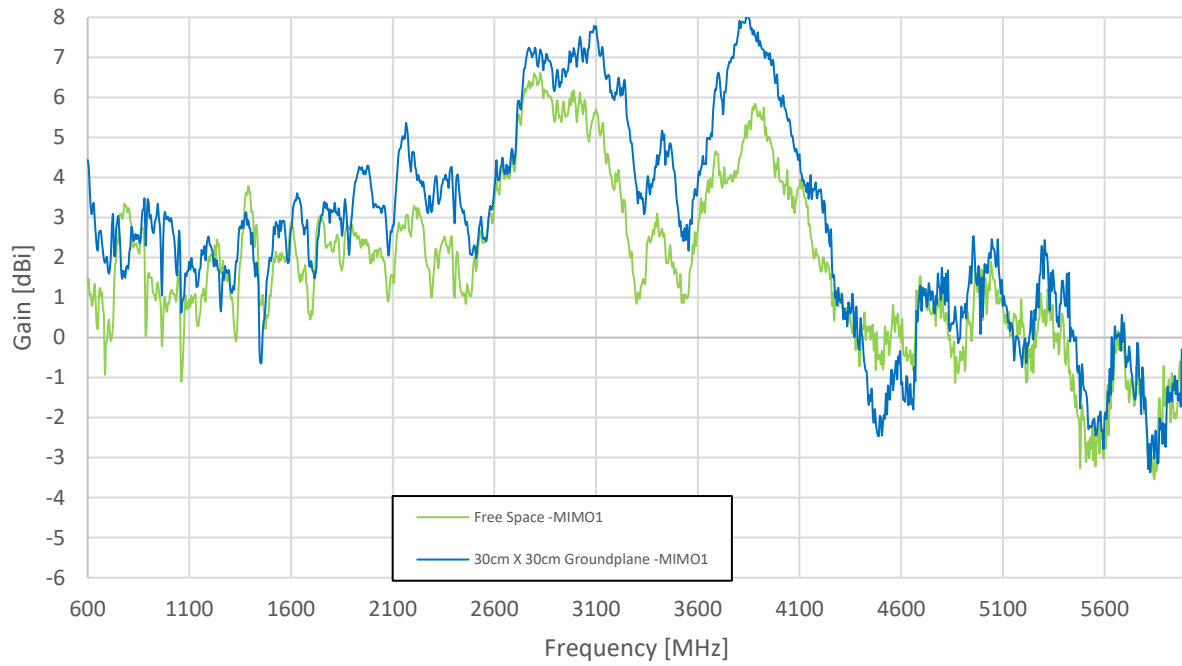

### 3.4 Average Gain

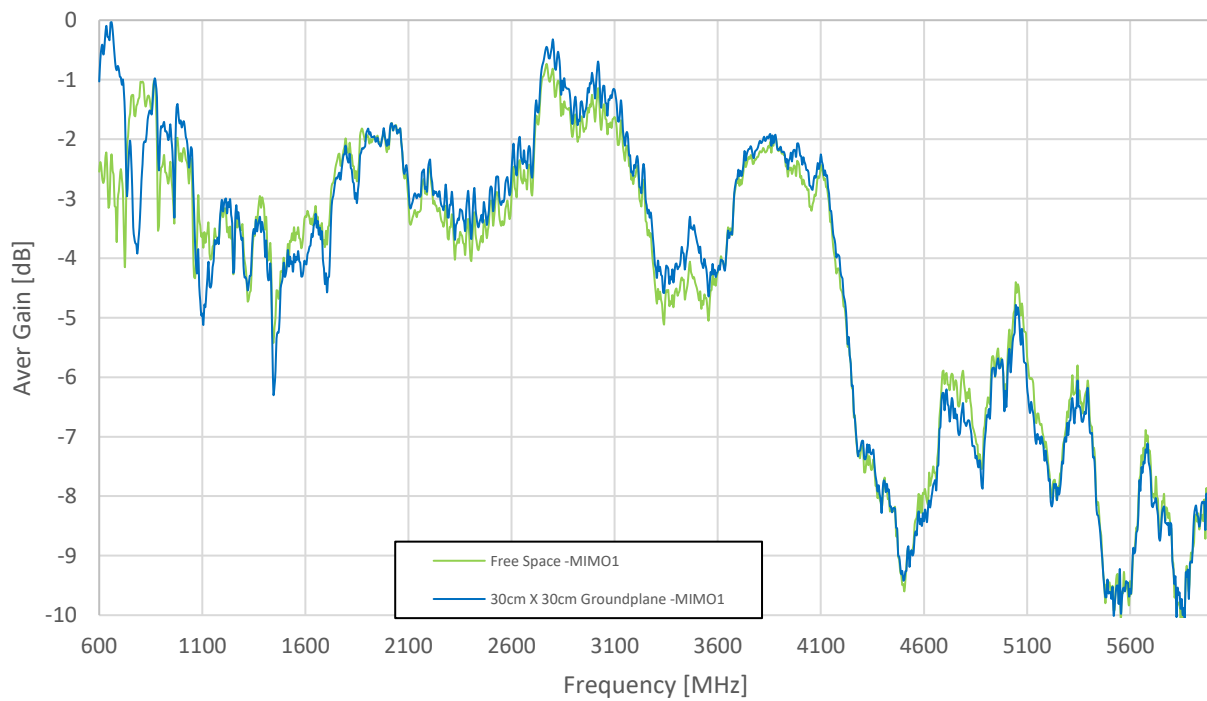

### 3.5 Return Loss – WiFi (2.4/5 GHz)

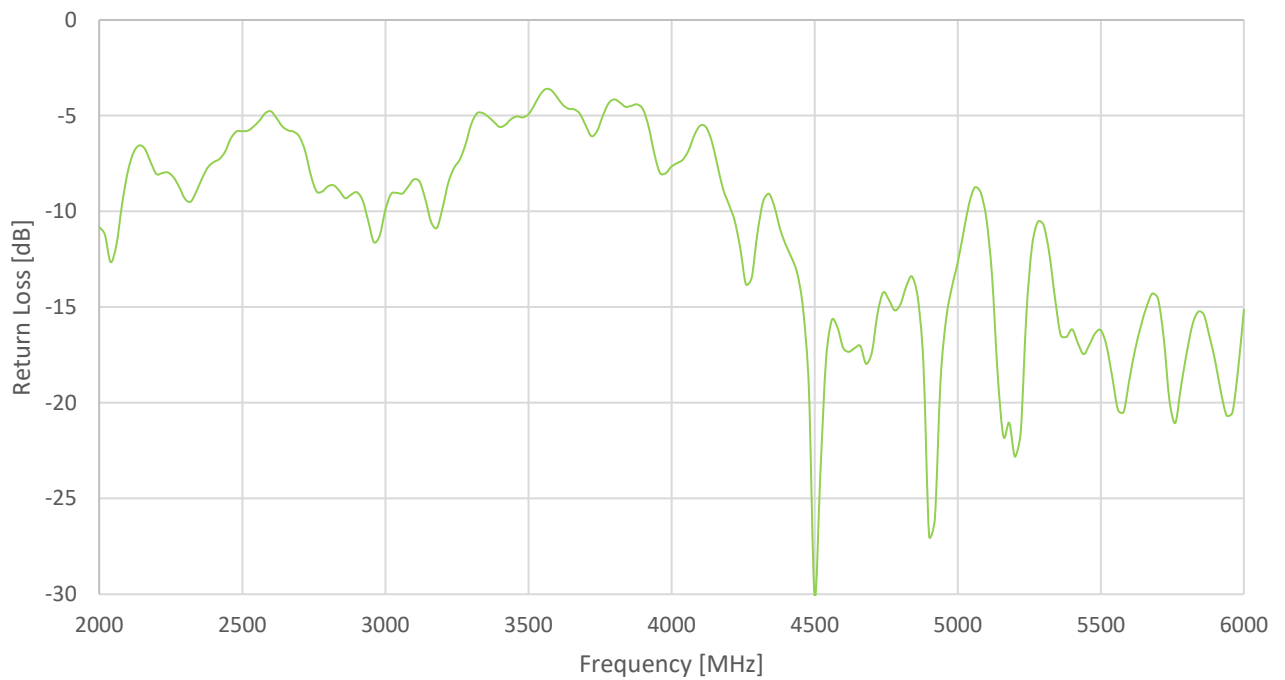

### 3.6 VSWR - WiFi (2.4/5 GHz)

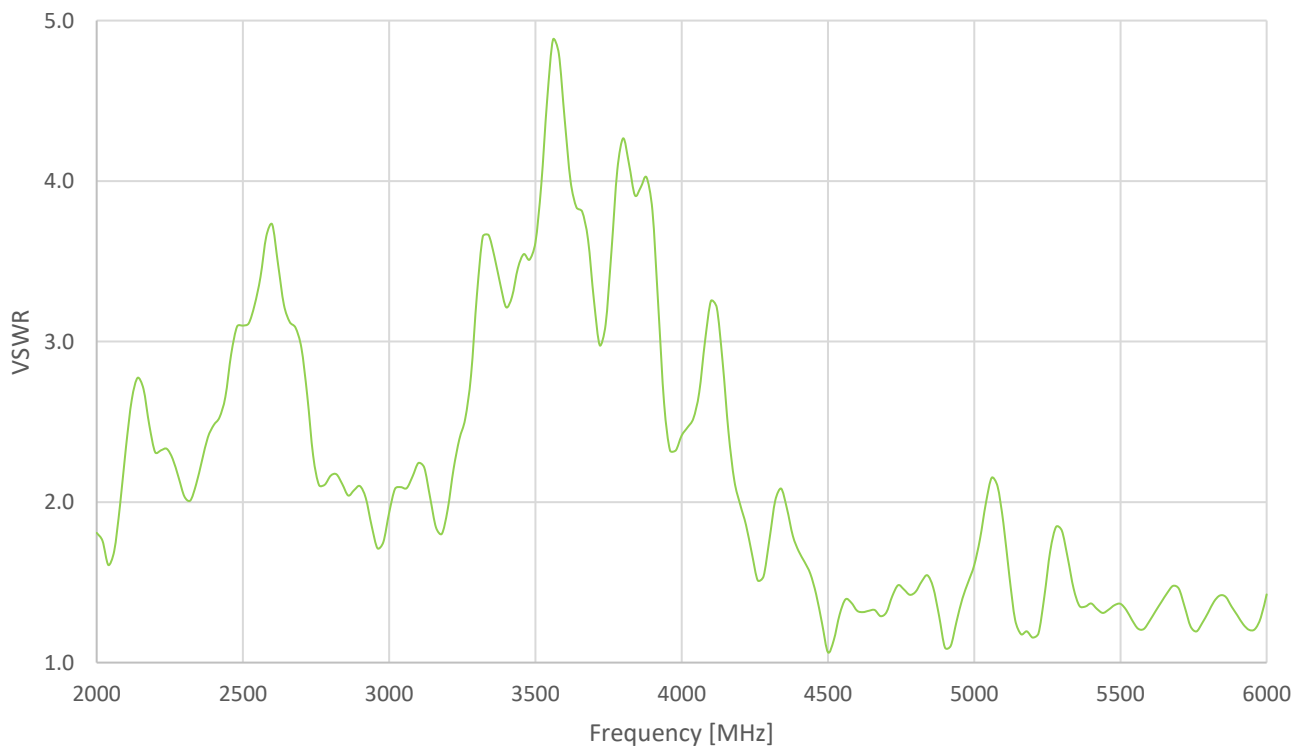

### 3.7 Efficiency - WiFi (2.4/5 GHz)

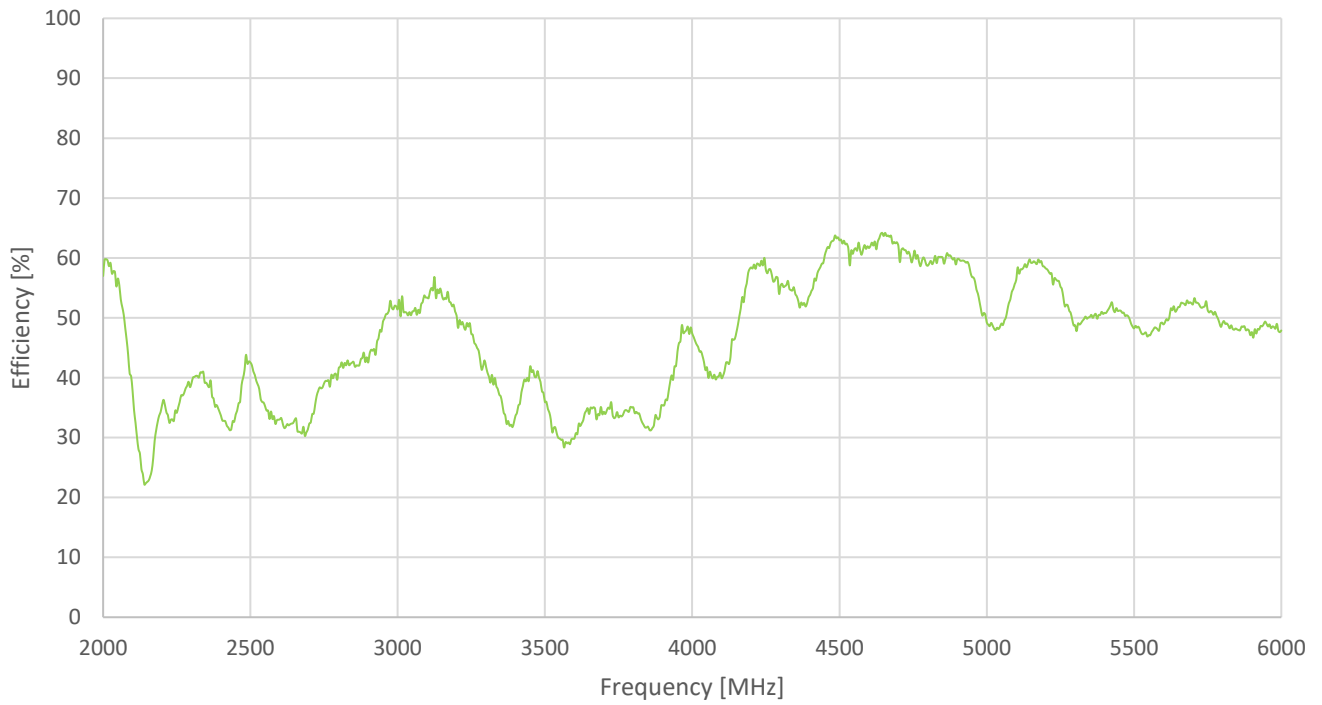

### 3.8 Peak Gain - WiFi (2.4/5 GHz)

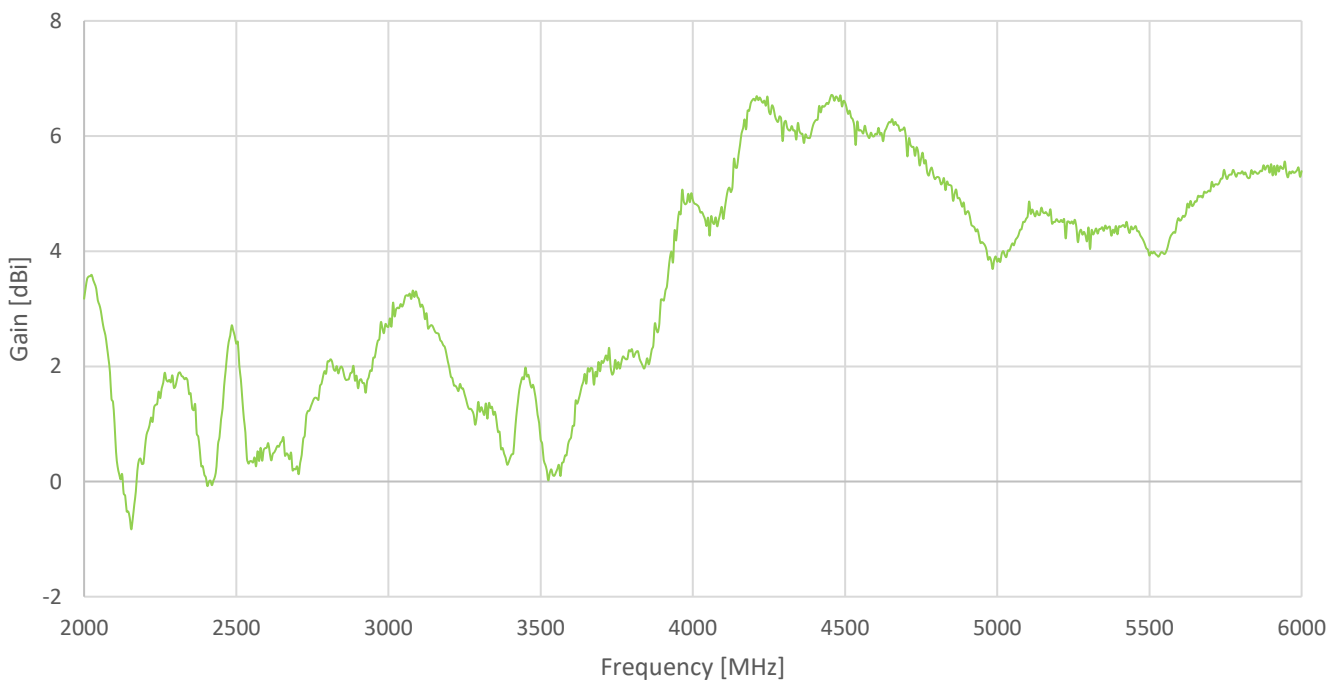

### 3.10 Average Gain - WiFi (2.4/5 GHz)

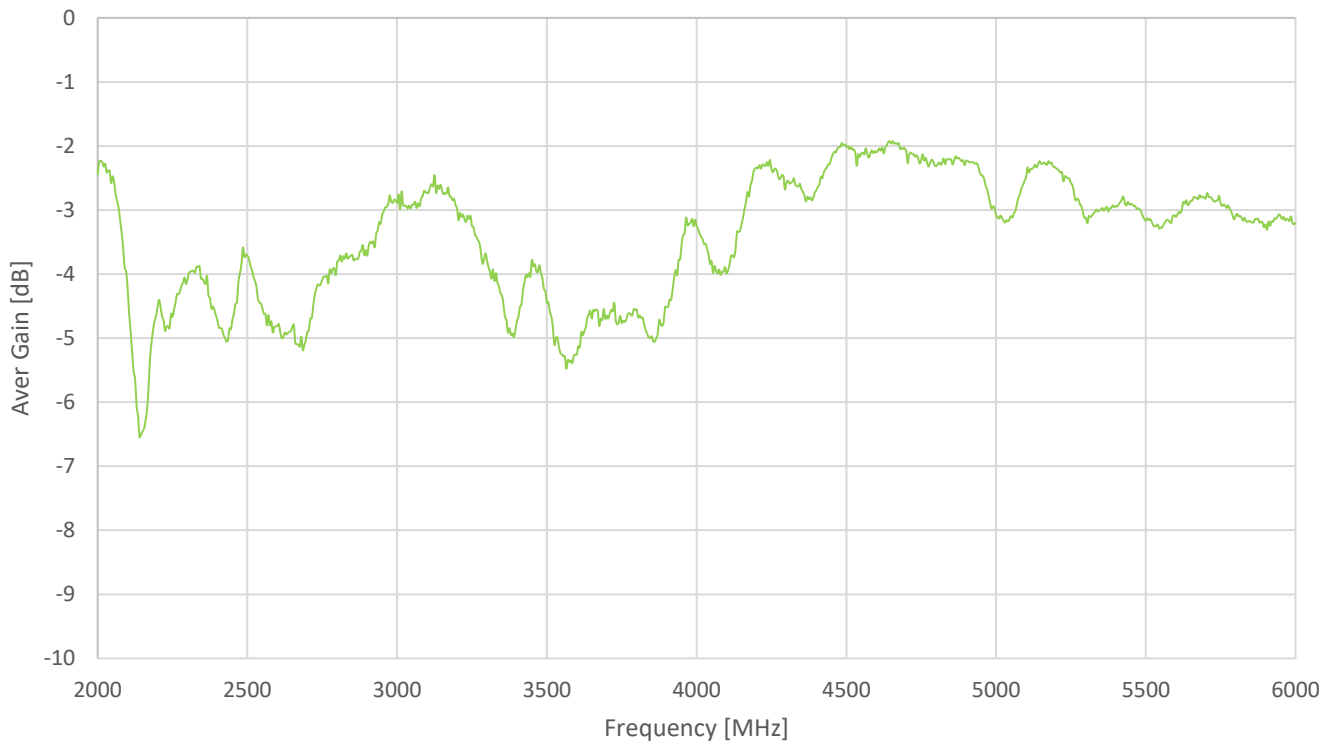

### 3.11 Block Diagram - GPS/GLONASS/GALILEO

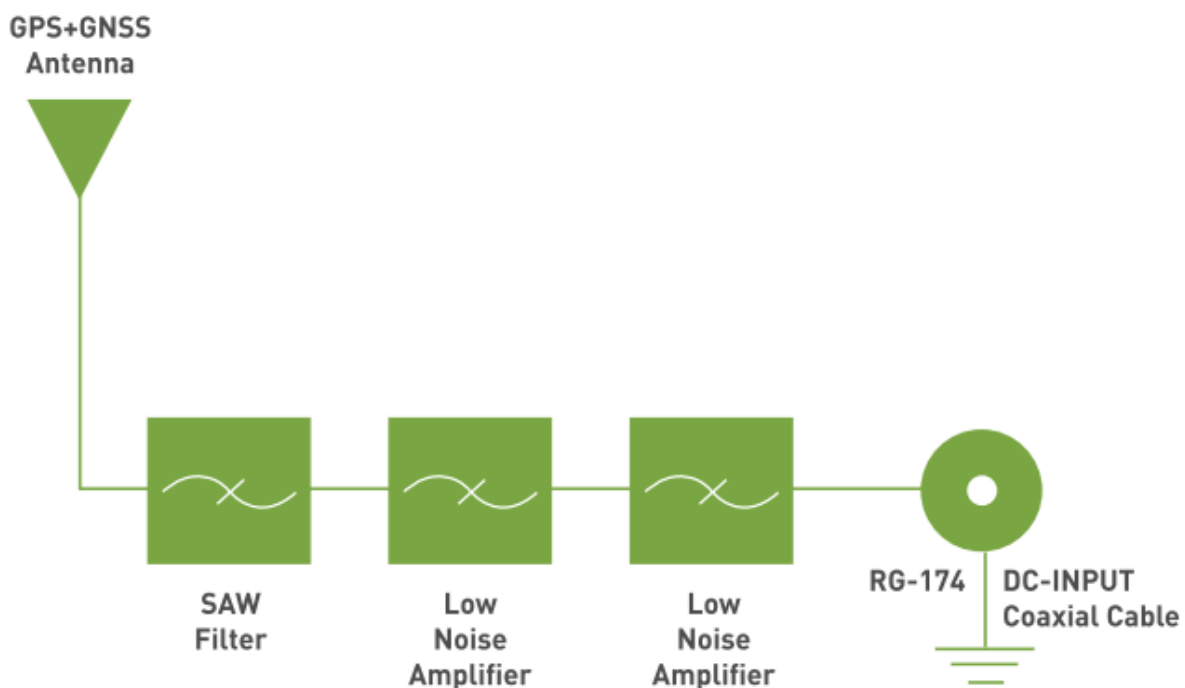

### 3.12 Return Loss - GNSS

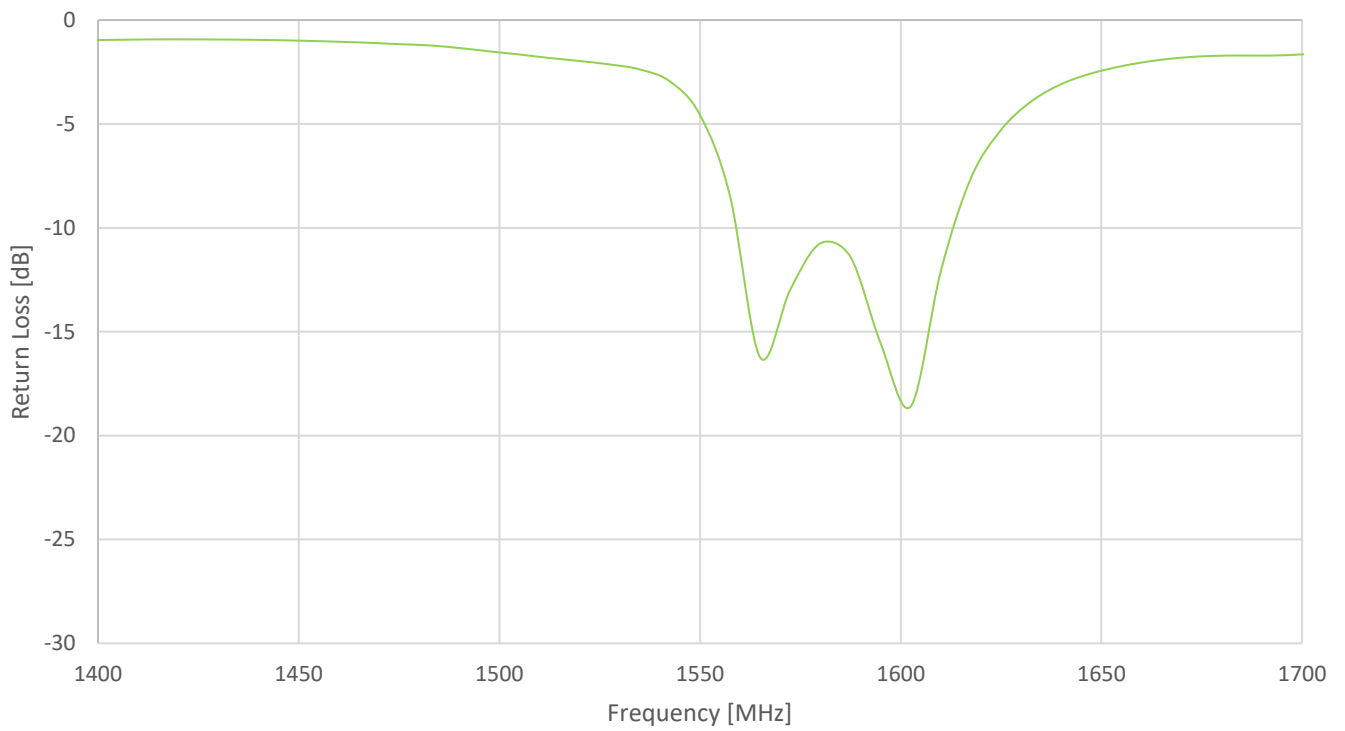

### 3.13 GNSS – Efficiency

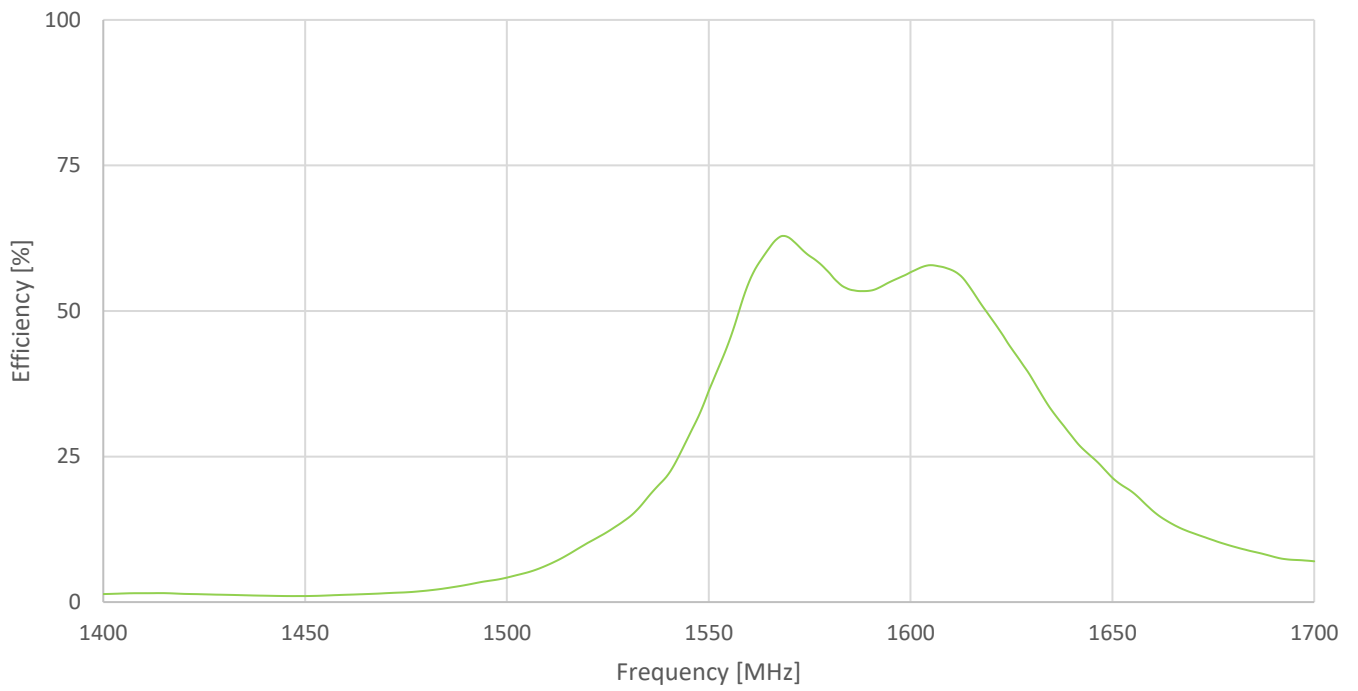

### 3.14 GNSS – Peak Gain

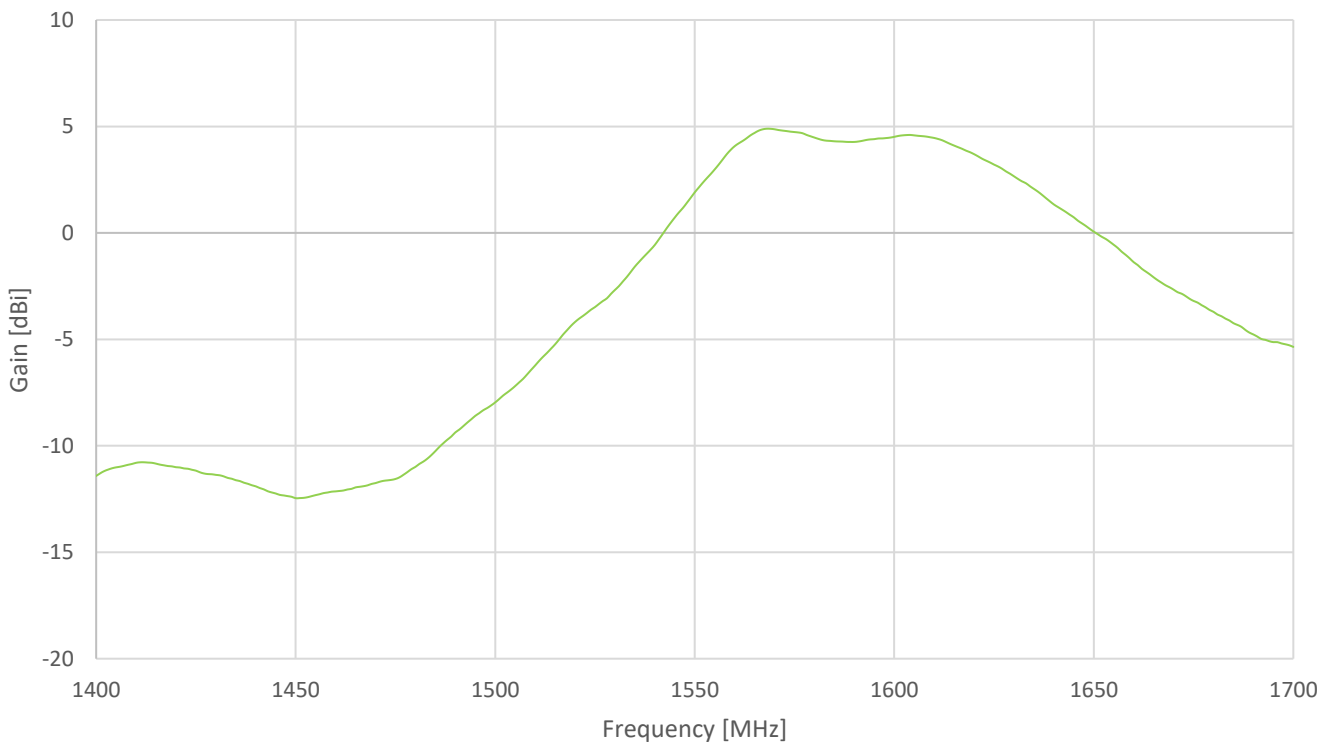

### 3.15 GNSS – Average Gain

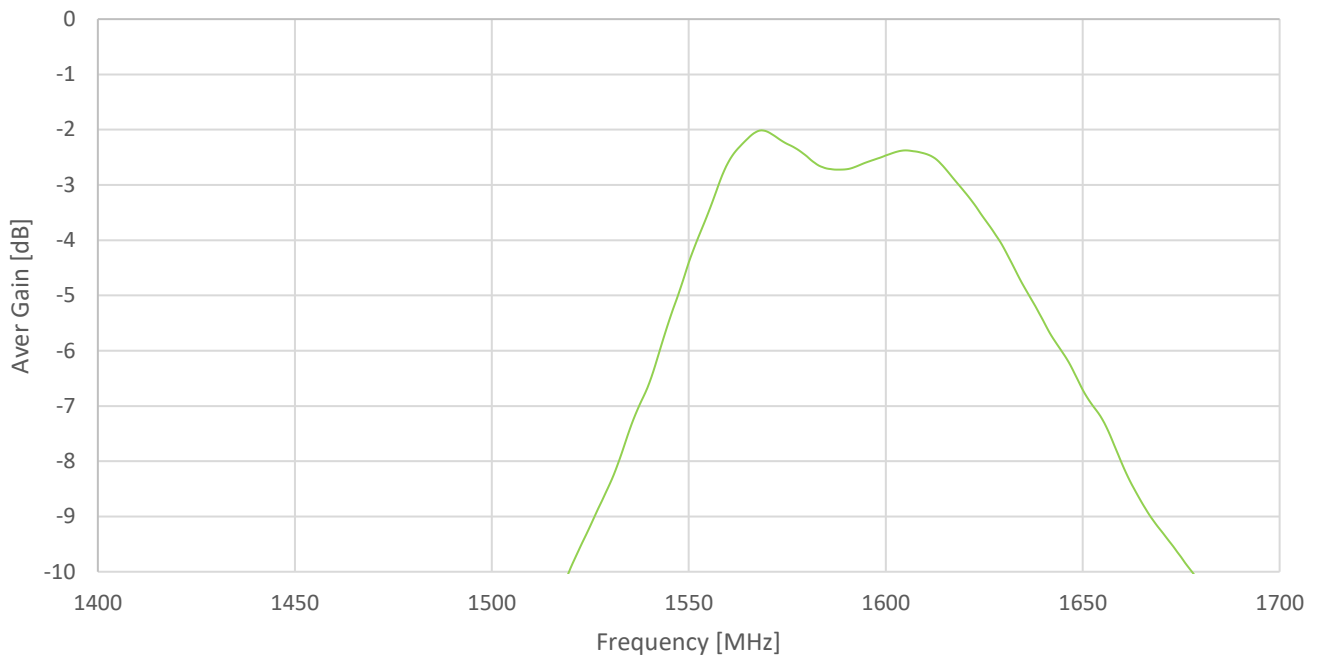

### 3.16 GNSS - Axial Ratio

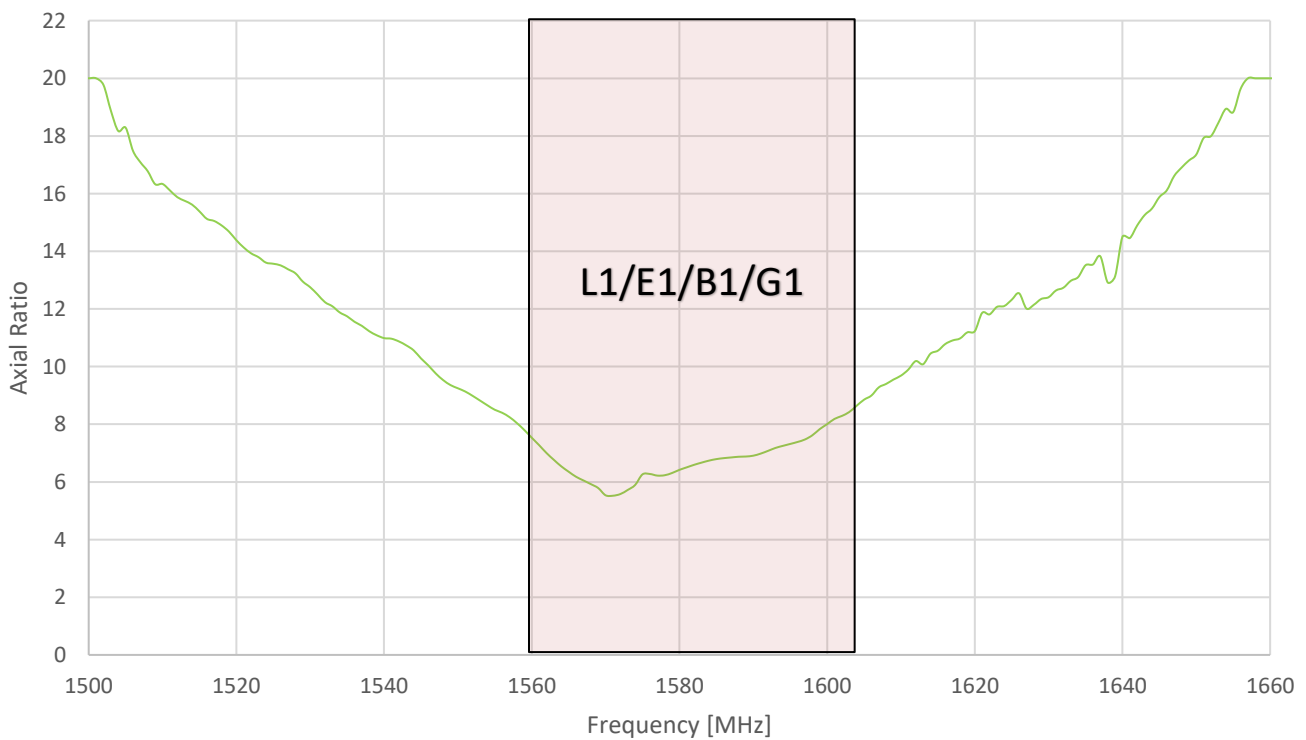

## 4. Radiation Patterns

### 4.1 Test Setup

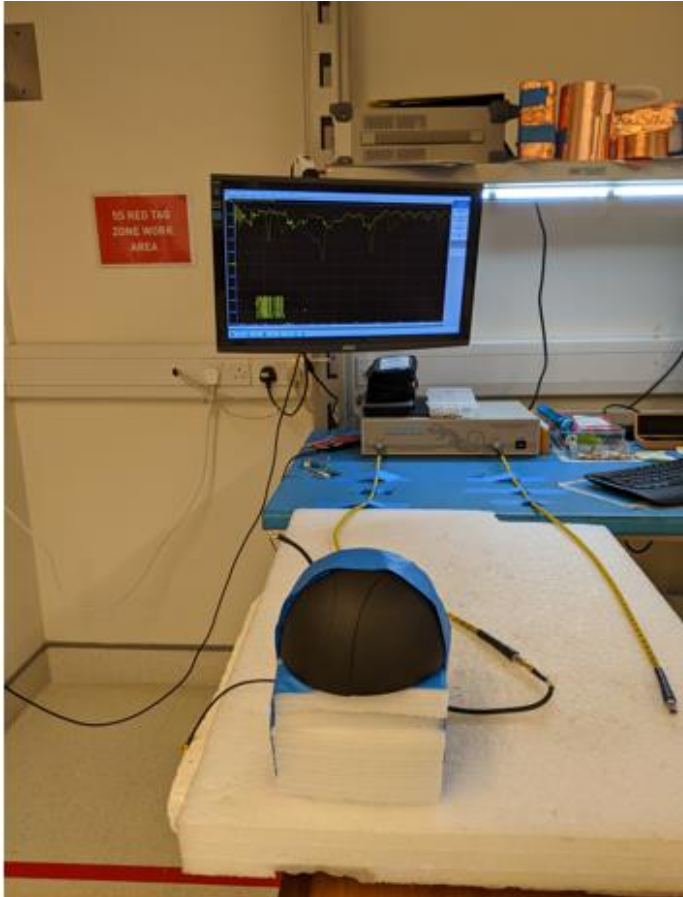

VNA Test Set-up

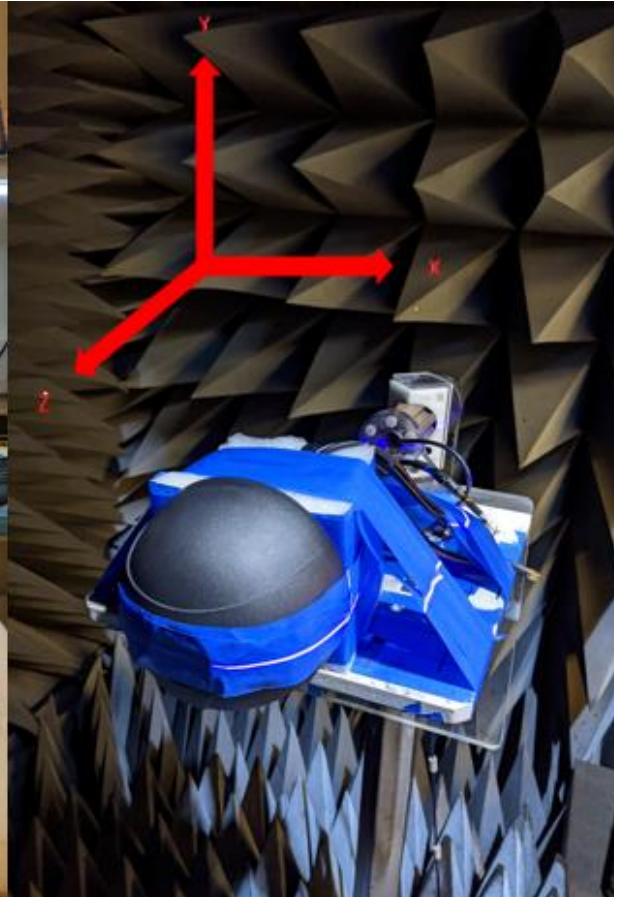

Chamber Test Set-up

## 4.2 705MHz 3D and 2D Cellular Radiation Patterns

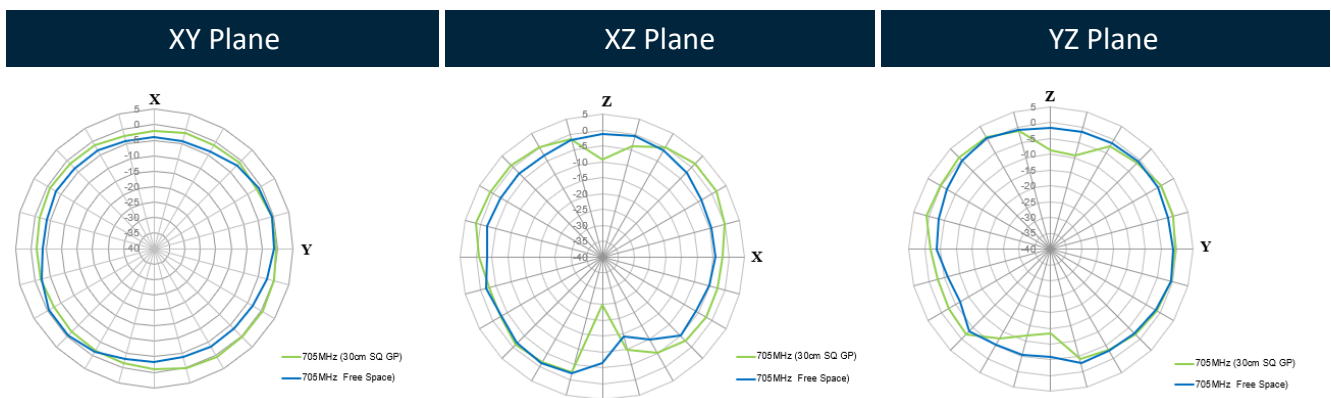
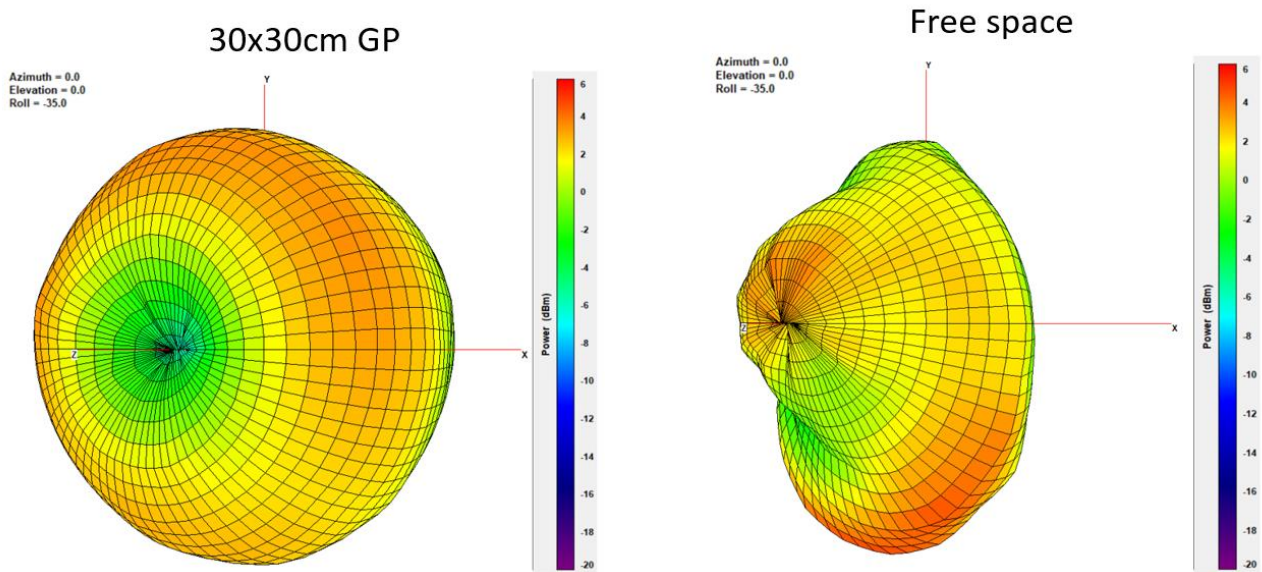

# 750MHz

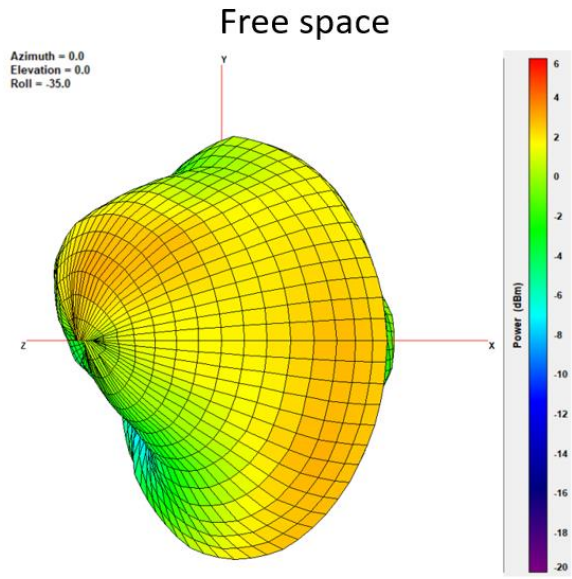
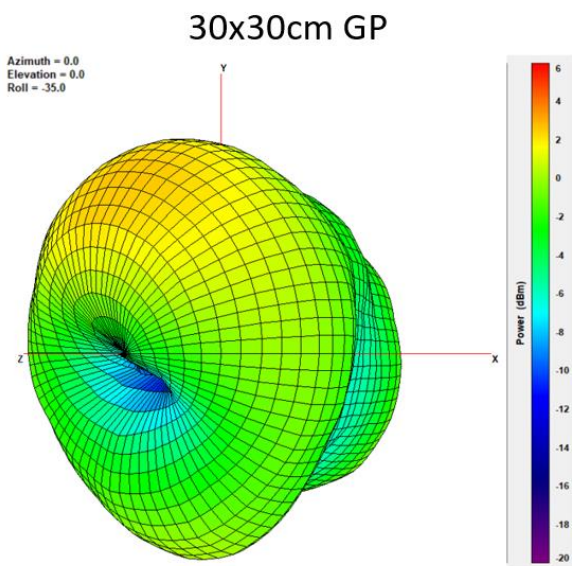

## XY Plane

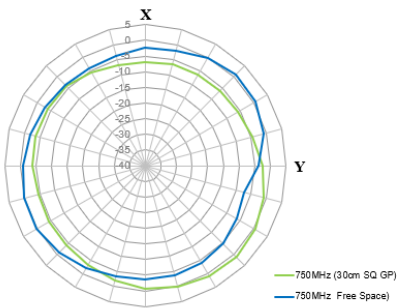

## XZ Plane

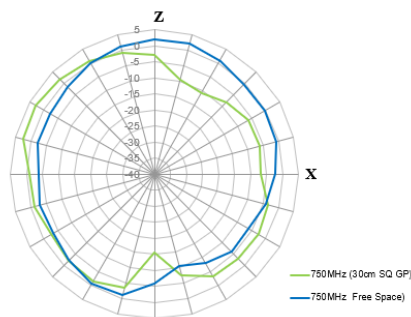

## YZ Plane

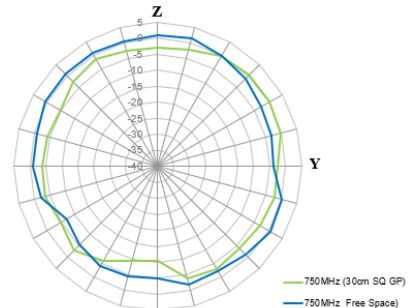

# 825MHz

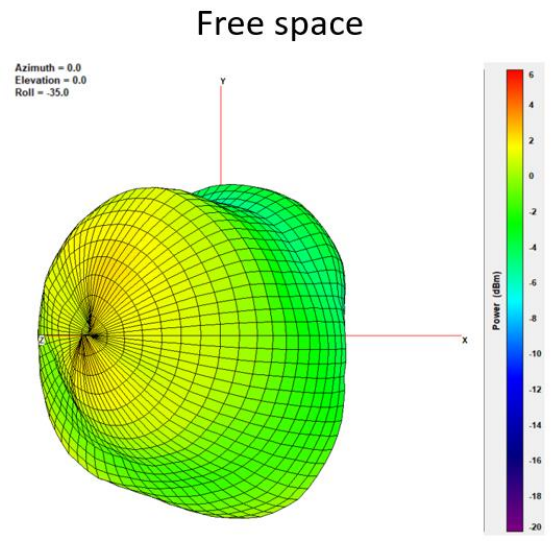
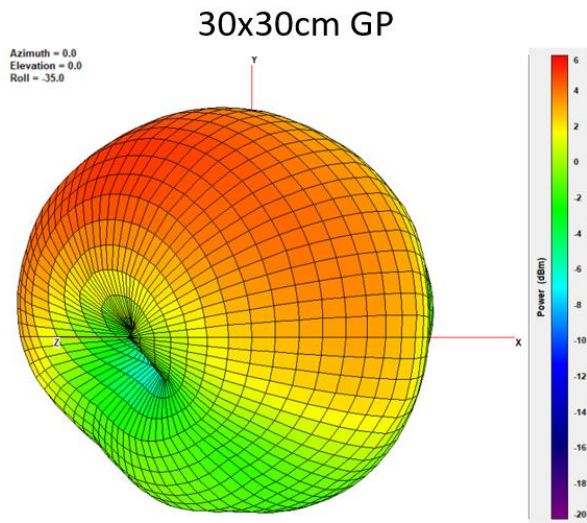

## XY Plane

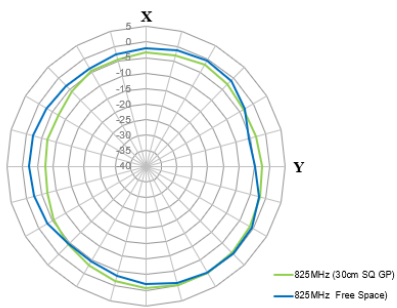

## XZ Plane

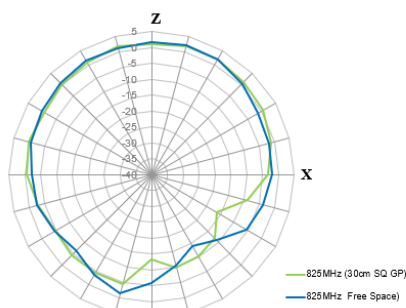

## YZ Plane

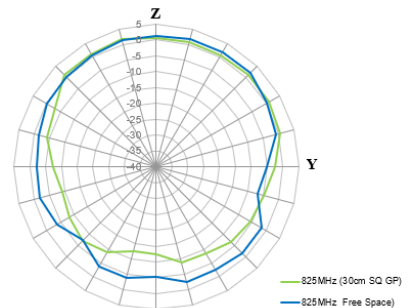

# 880MHz

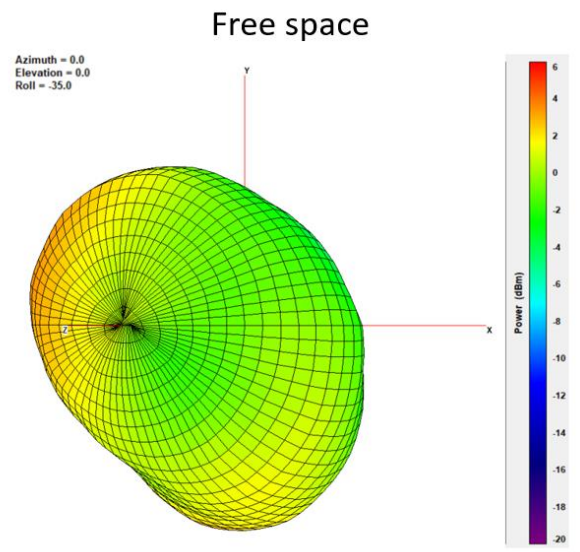
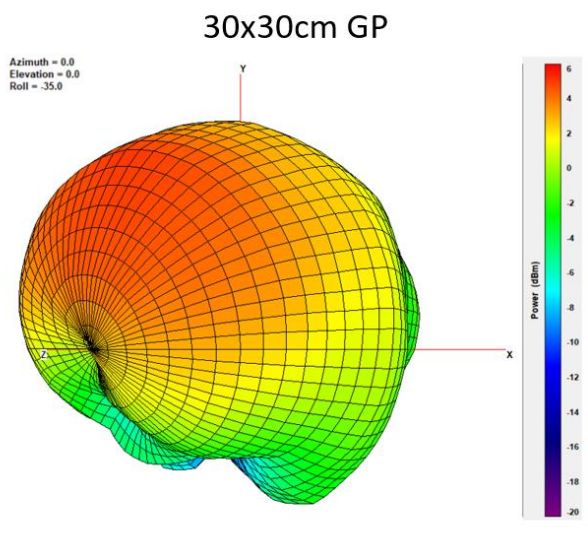

## XY Plane

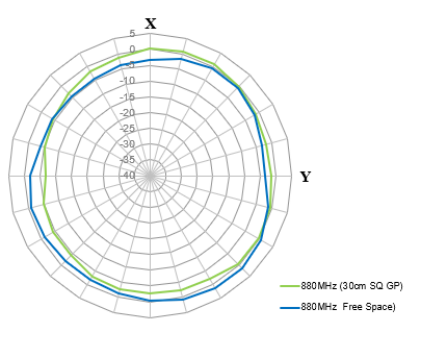

## XZ Plane

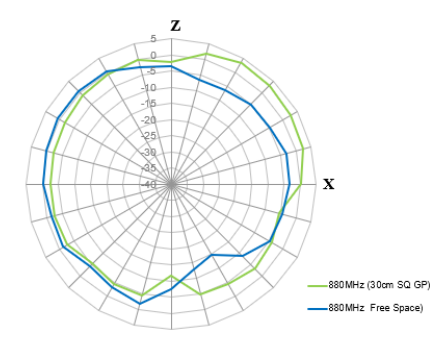

## YZ Plane

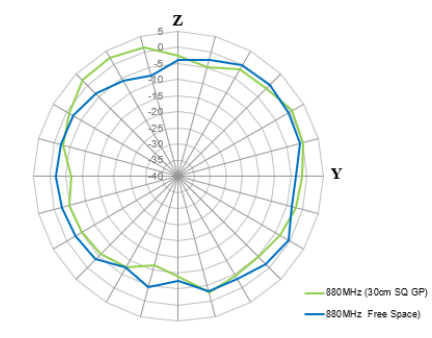

# 960MHz

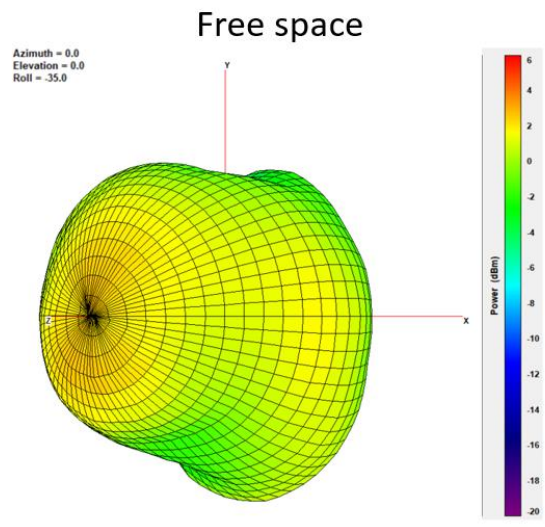
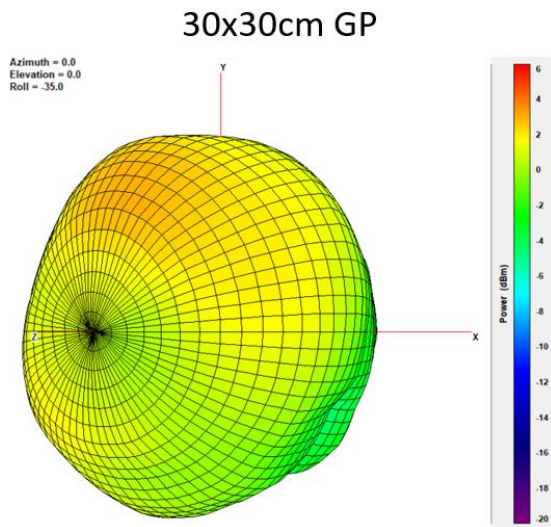

## XY Plane

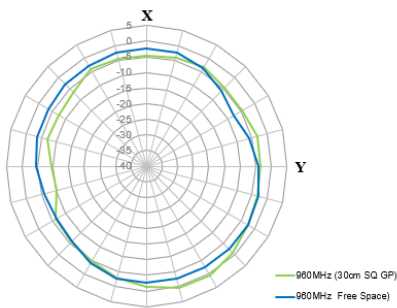

## XZ Plane

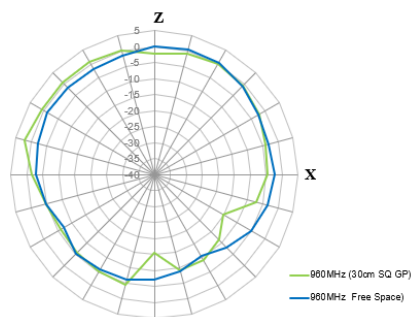

## YZ Plane

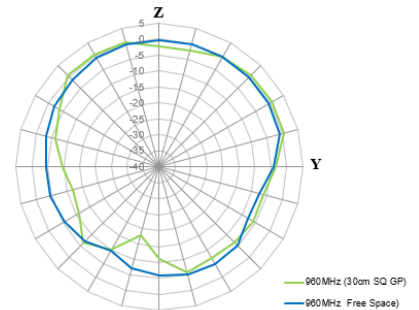

# 1710MHz

**30x30cm GP**

Azimuth = 0.0  
Elevation = 0.0  
Roll = -35.0

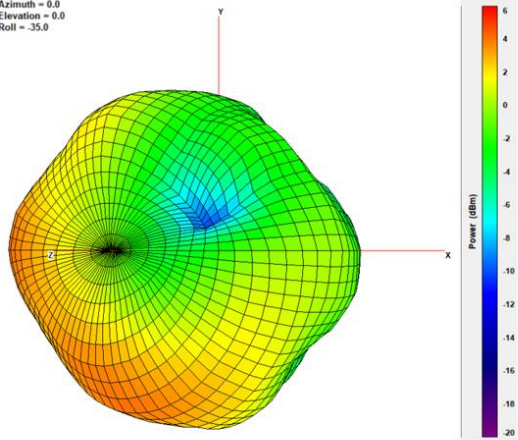

**Free space**

Azimuth = 0.0  
Elevation = 0.0  
Roll = -35.0

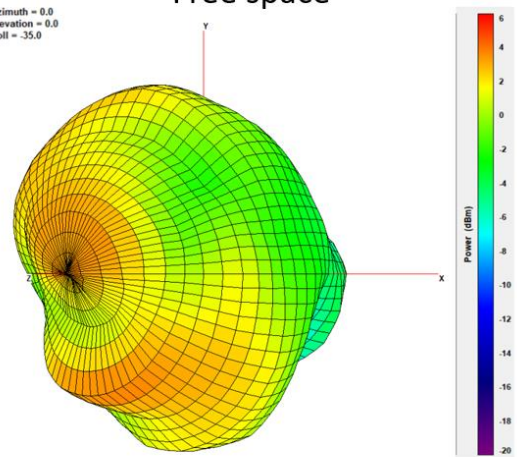

**XY Plane**

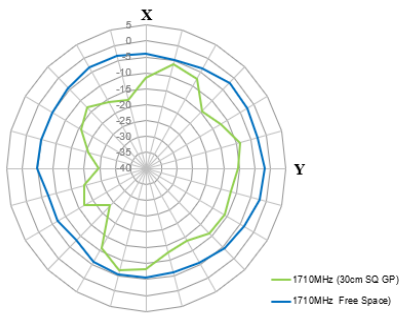

**XZ Plane**

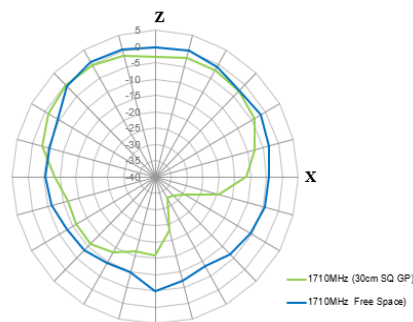

**YZ Plane**

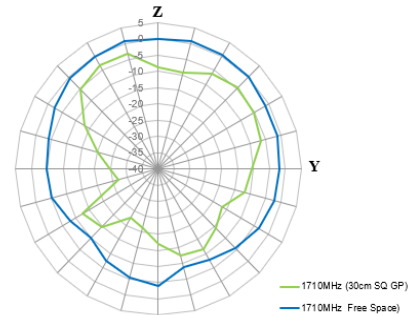

# 1880MHz

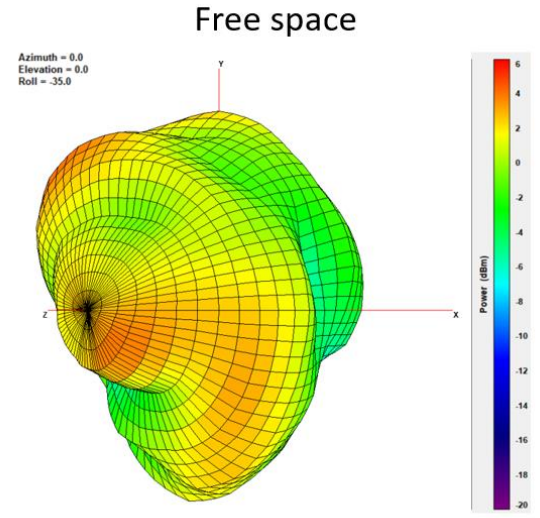
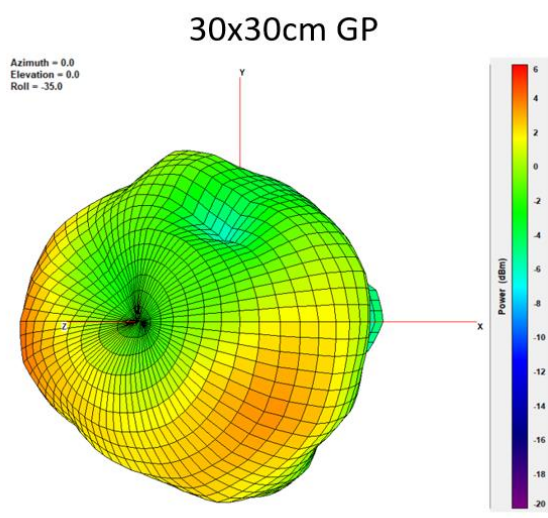

## XY Plane

## XZ Plane

## YZ Plane

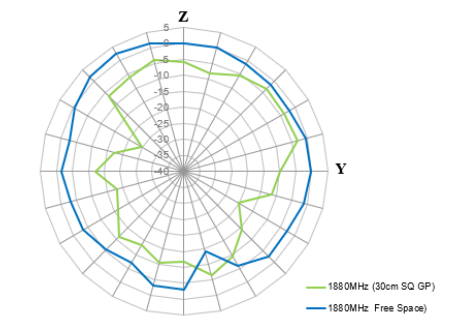
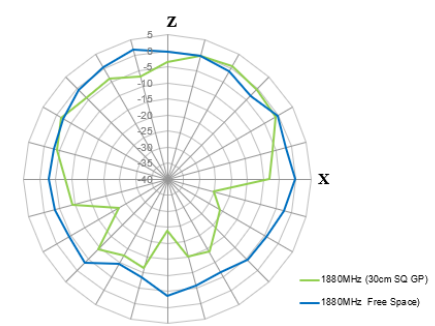
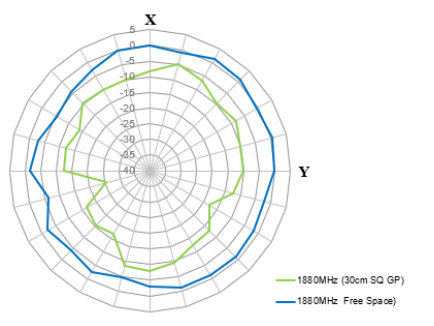

1990MHz

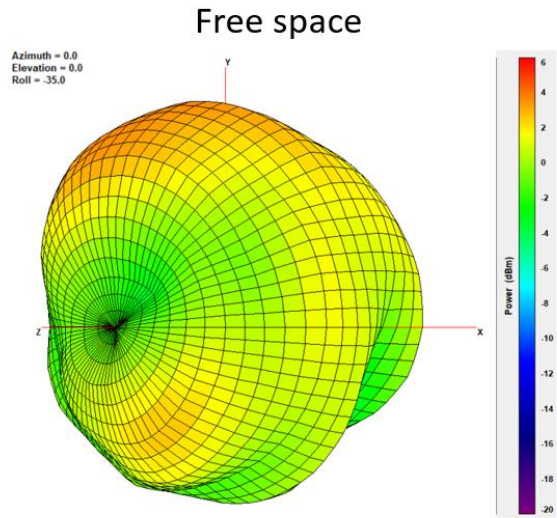
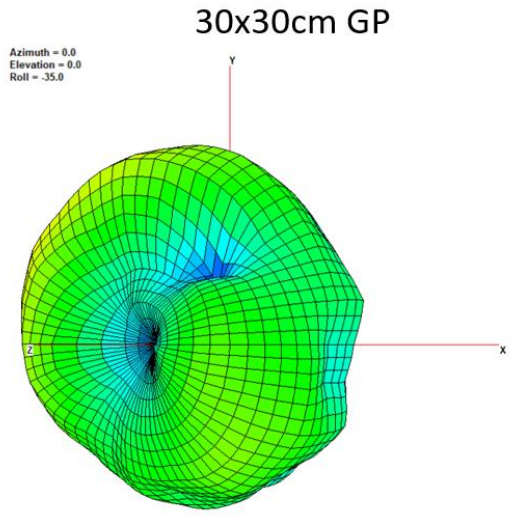

XY Plane

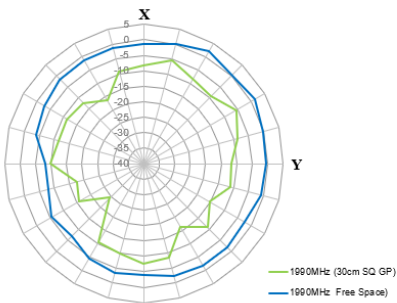

XZ Plane

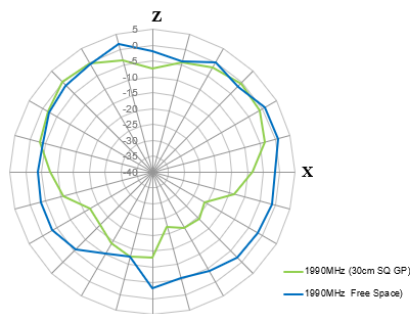

YZ Plane

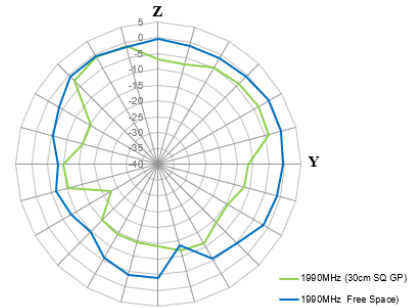

# 2170MHz

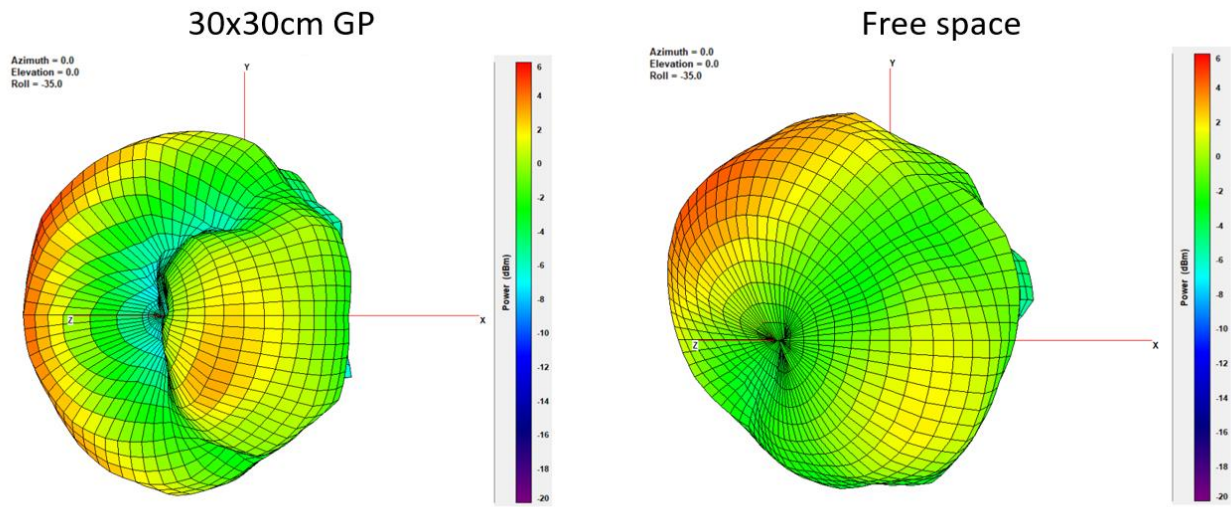

## XY Plane

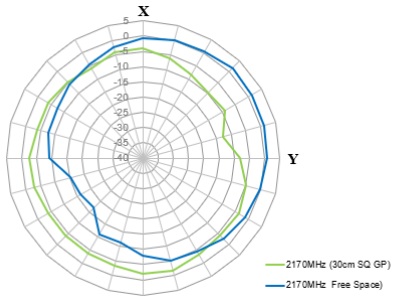

## XZ Plane

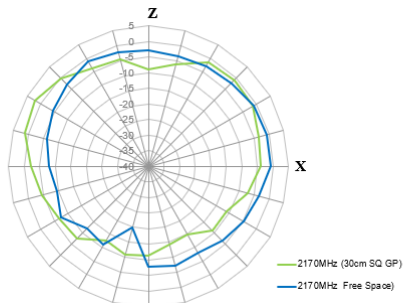

## YZ Plane

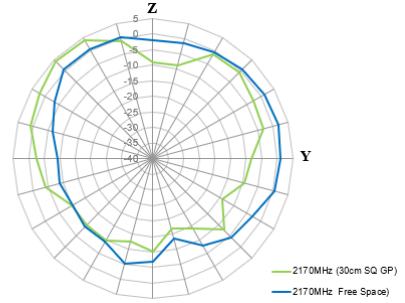

2300MHz

30x30cm GP

Azimuth = 0.0  
Elevation = 0.0  
Roll = -35.0

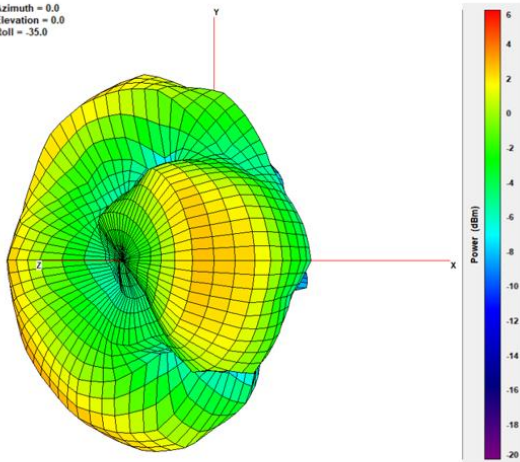

Free space

Azimuth = 0.0  
Elevation = 0.0  
Roll = -35.0

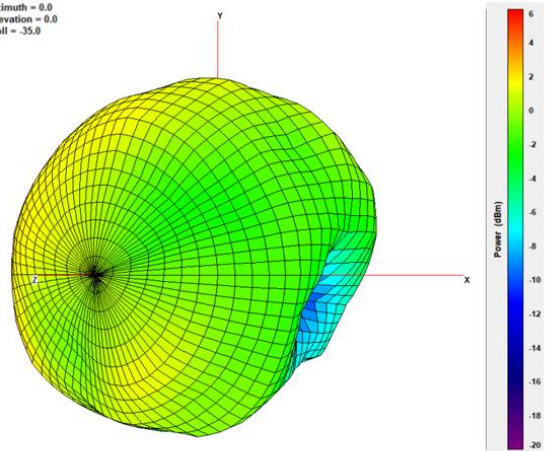

XY Plane

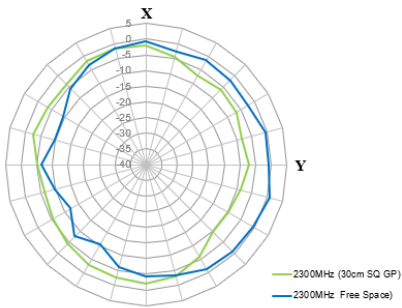

XZ Plane

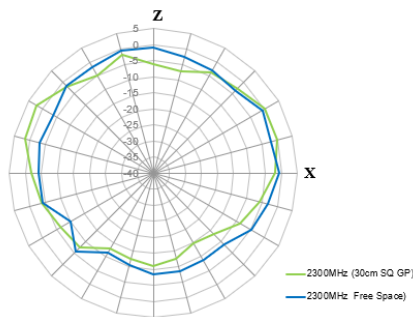

YZ Plane

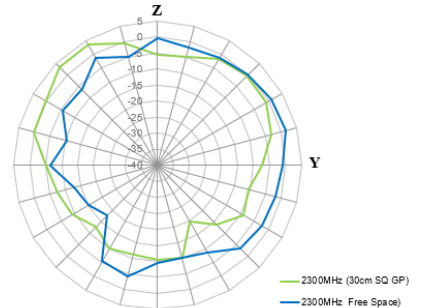

# 2500MHz

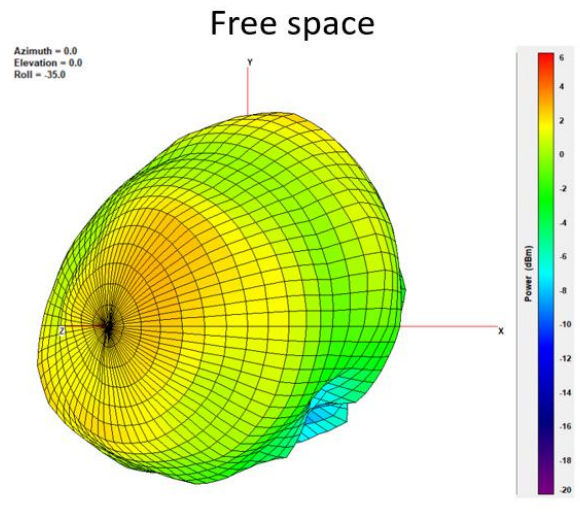

## XY Plane

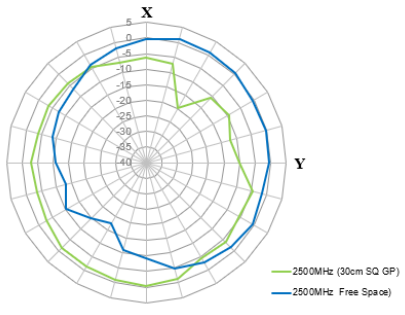

## XZ Plane

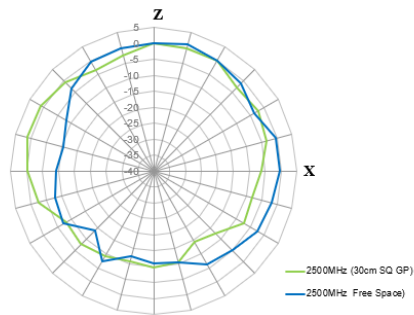

## YZ Plane

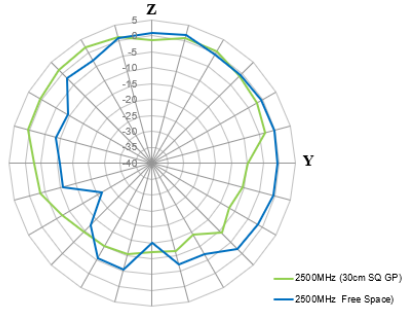

# 2570MHz

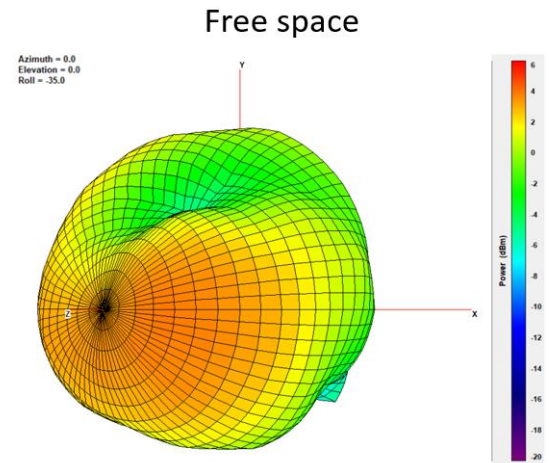
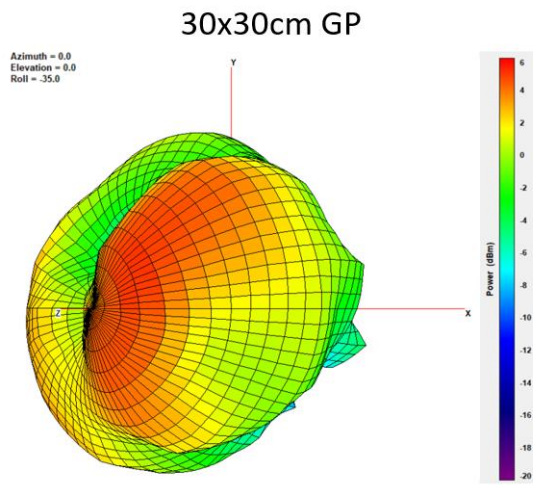

## XY Plane

## XZ Plane

## YZ Plane

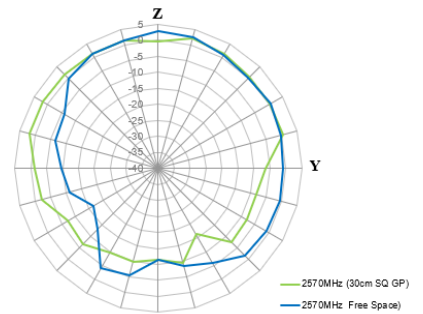
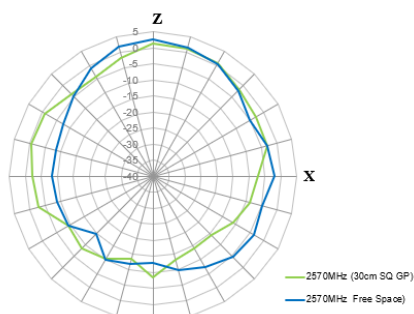
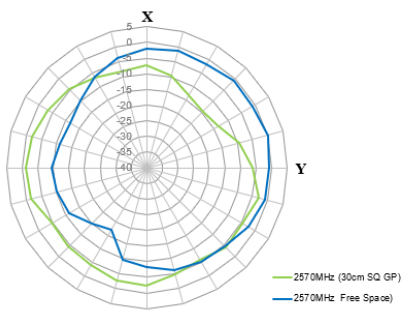

2700MHz

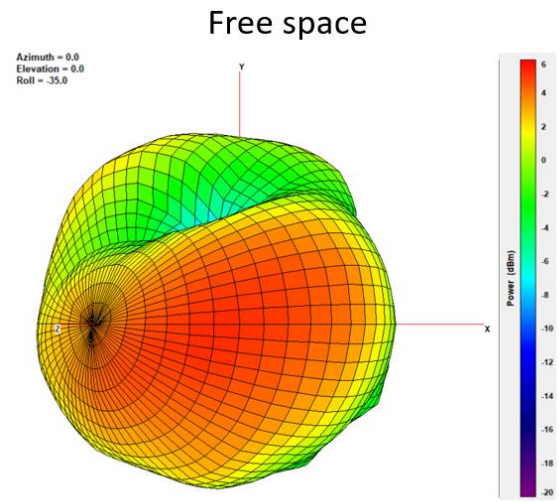
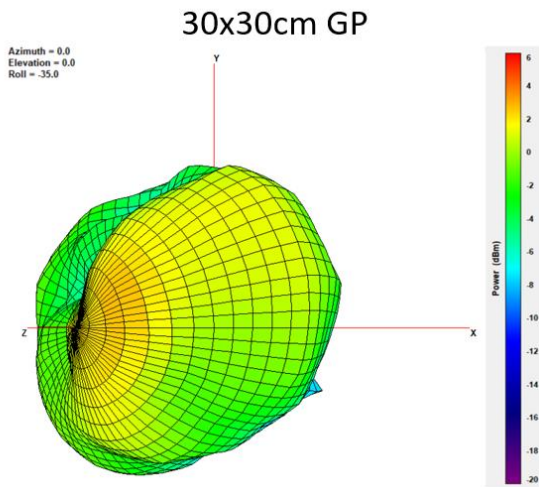

XY Plane

XZ Plane

YZ Plane

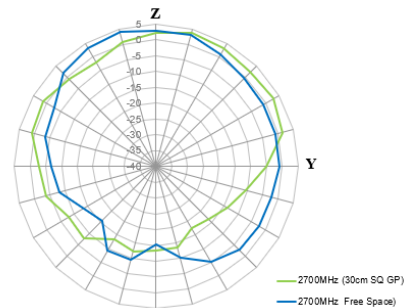
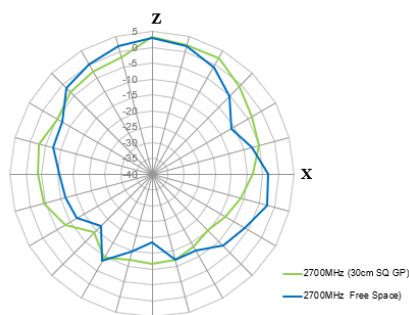
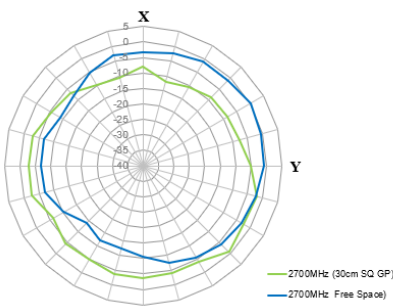

3200MHz

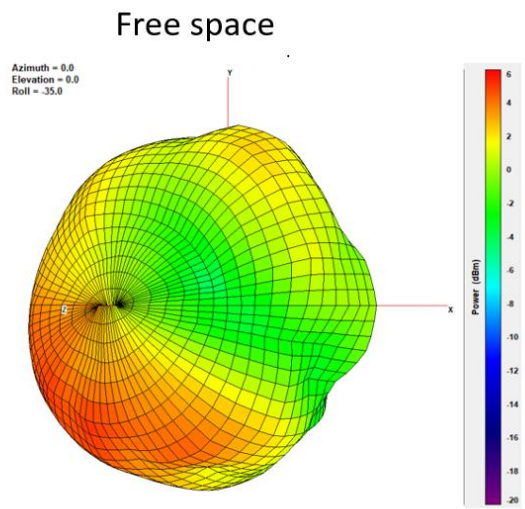
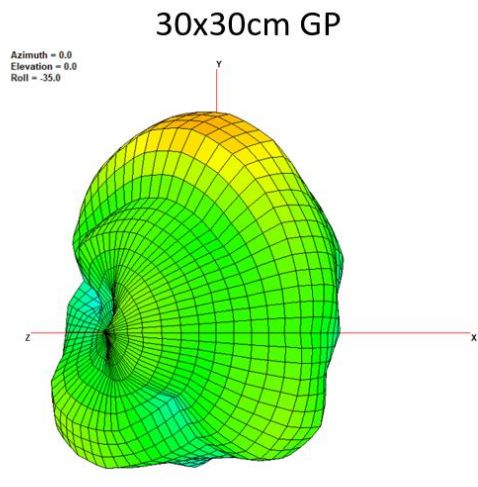

XY Plane

XZ Plane

YZ Plane

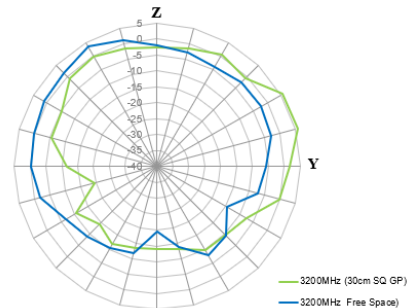
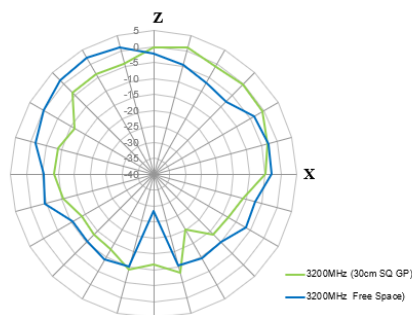
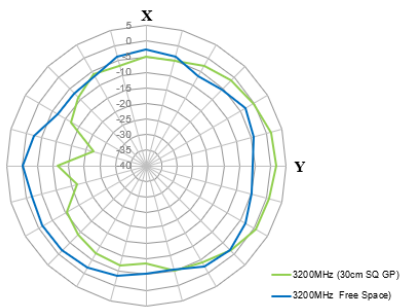

# 4200MHz

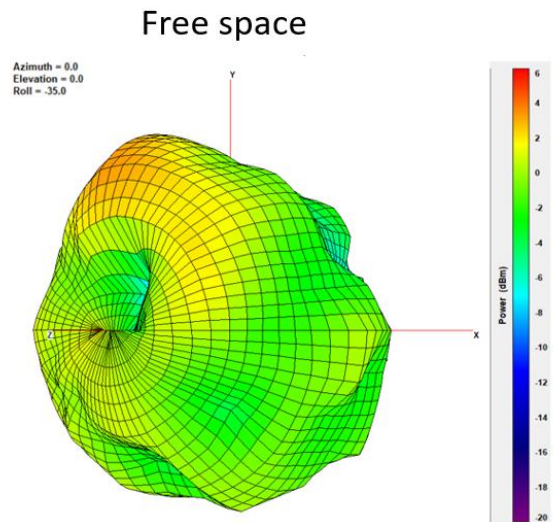
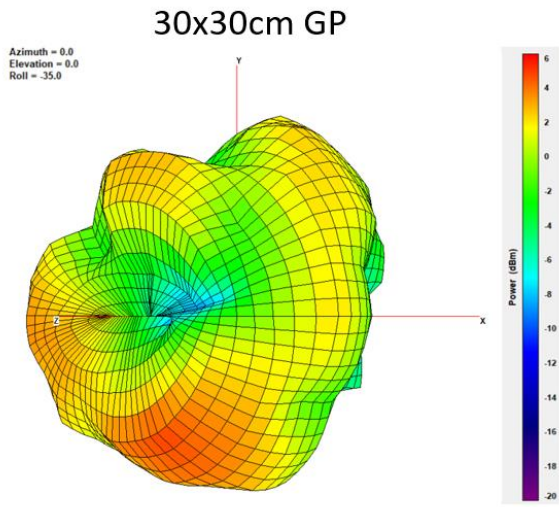

## XY Plane

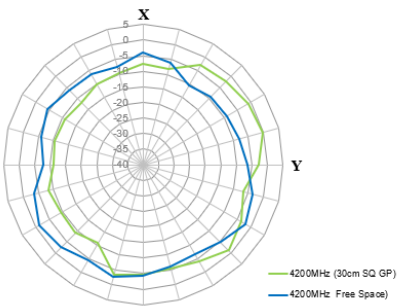

## XZ Plane

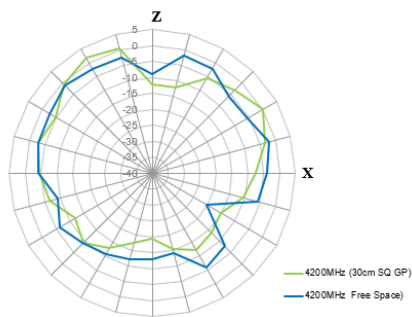

## YZ Plane

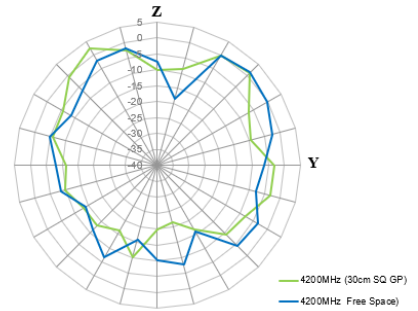

# 5150MHz

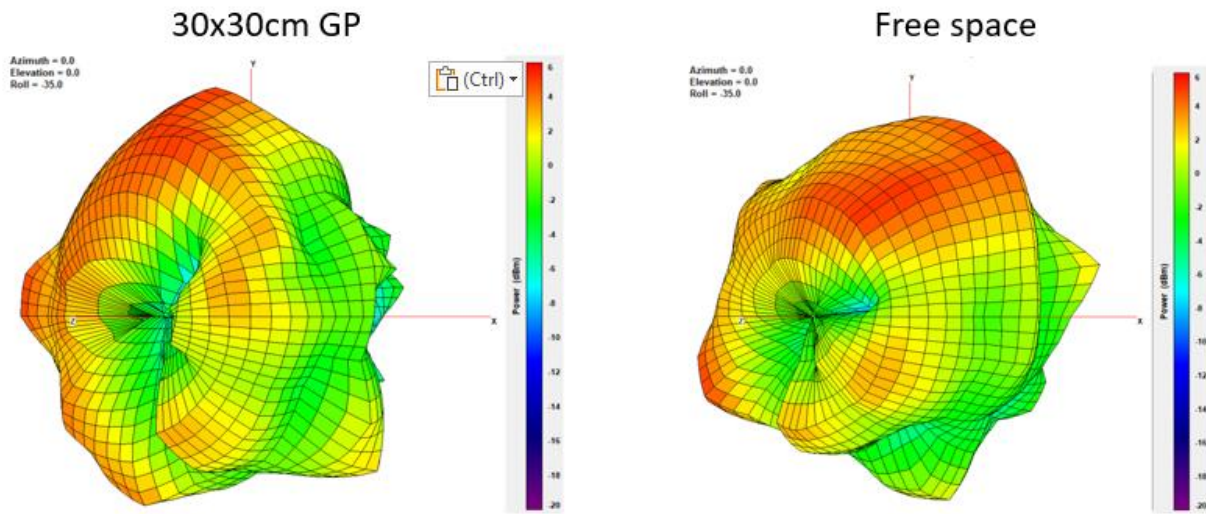

## XY Plane

## XZ Plane

## YZ Plane

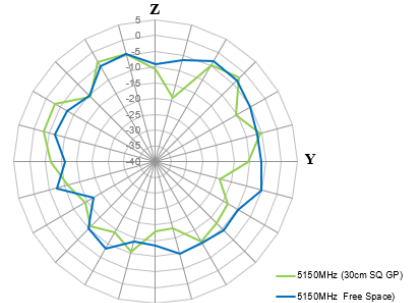
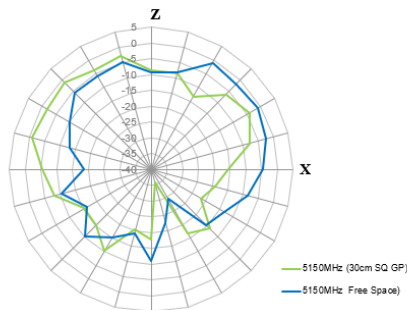
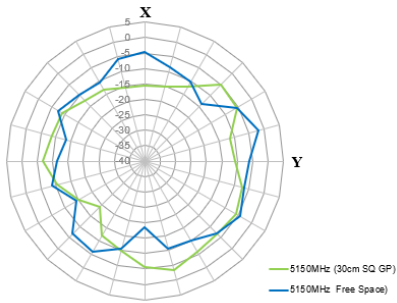

5550MHz

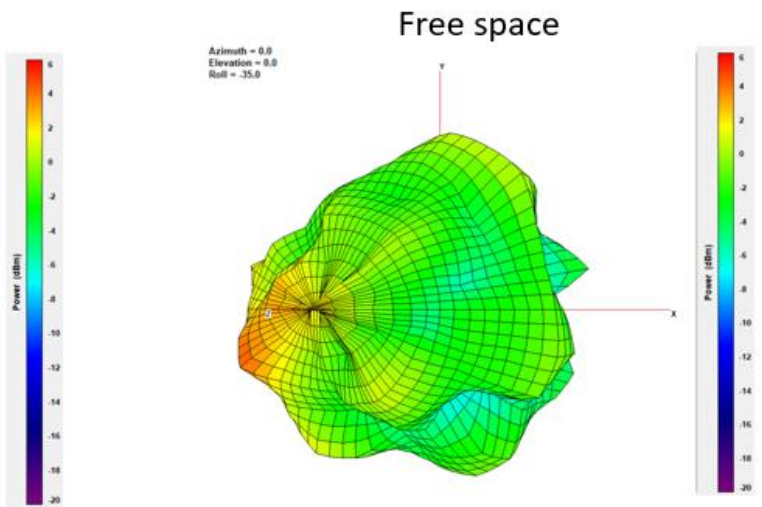
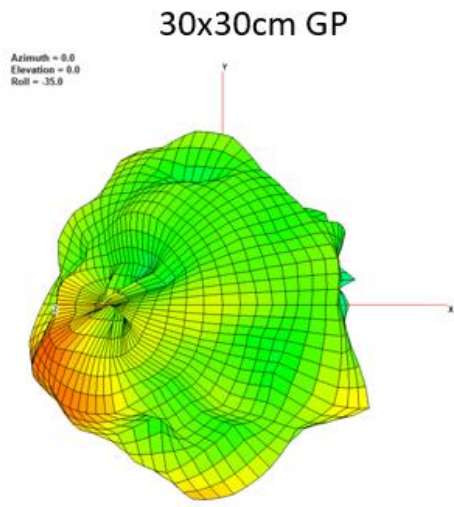

XY Plane

XZ Plane

YZ Plane

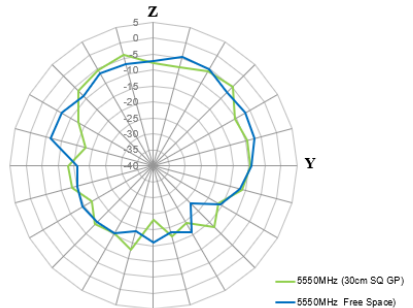
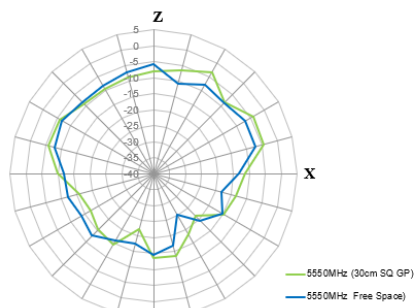
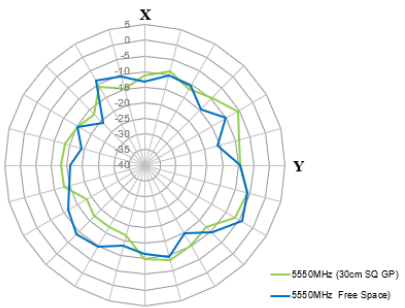

### 4.3 Wi-Fi 3D and 2D Radiation Patterns

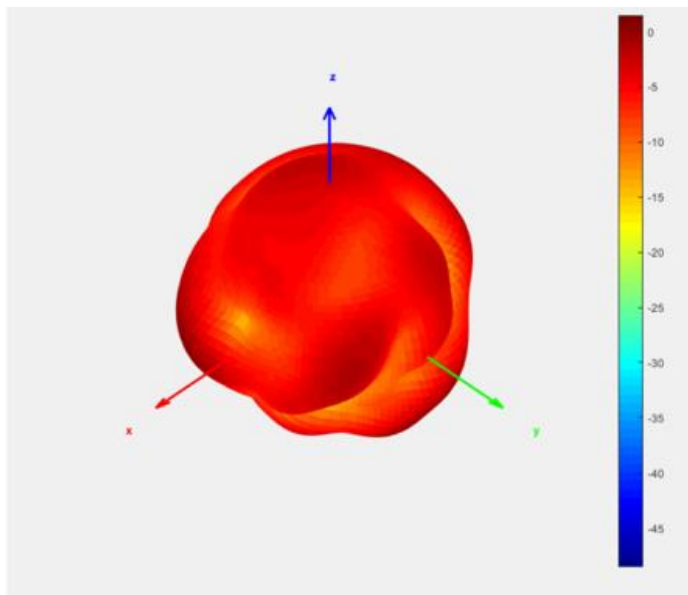

XZ Plane

YZ Plane

XY Plane

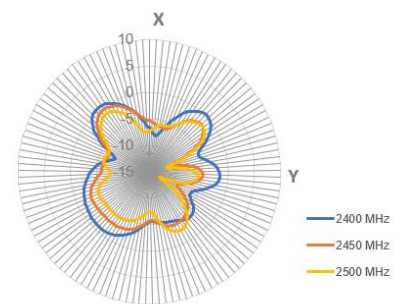
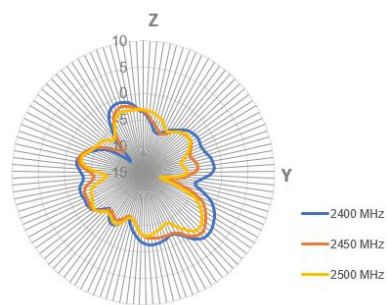
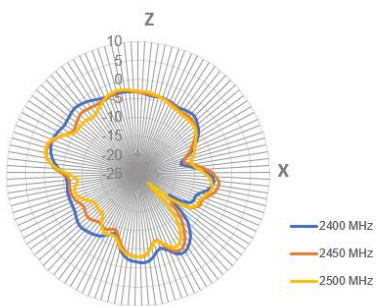

5.5GHz

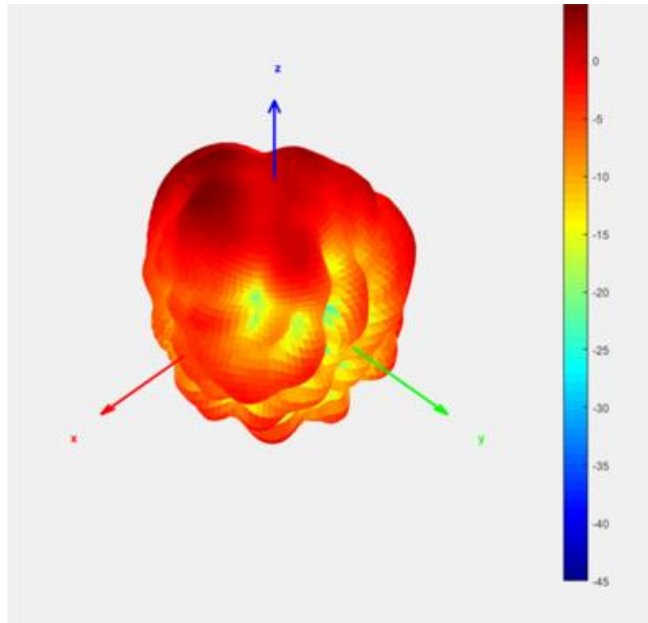

XZ Plane

YZ Plane

XY Plane

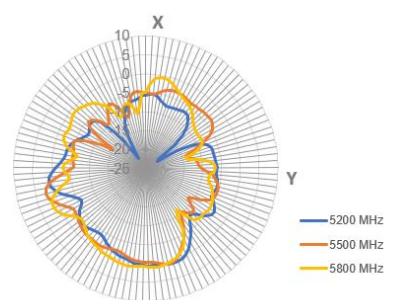
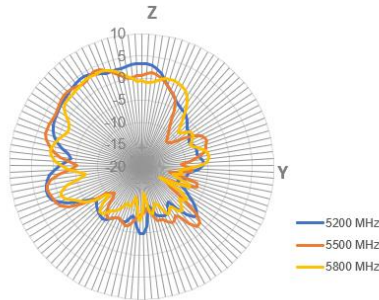
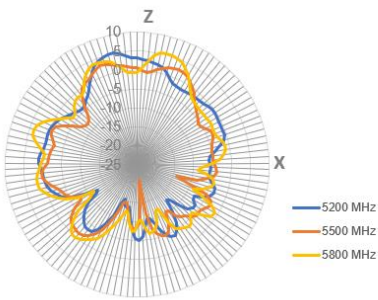

5.8GHz

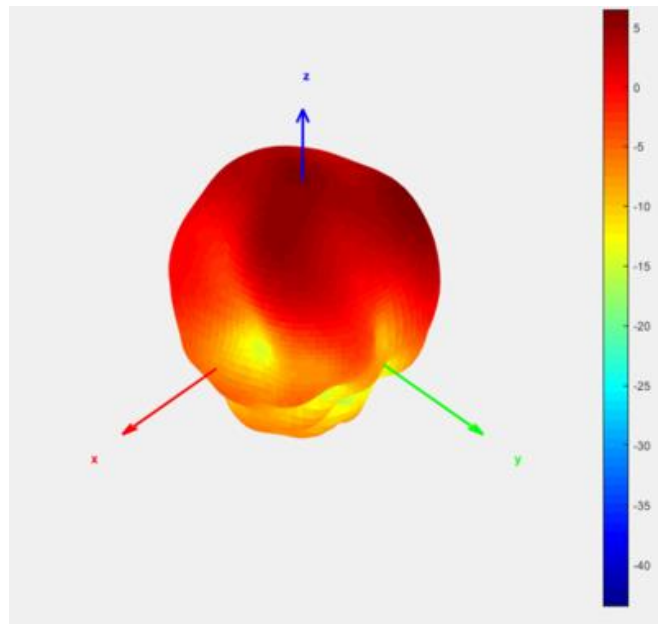

XZ Plane

YZ Plane

XY Plane

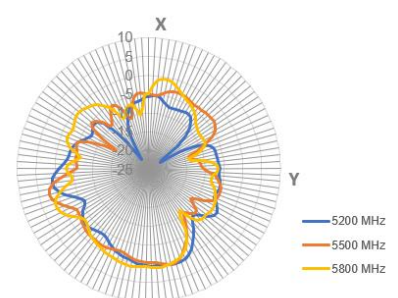
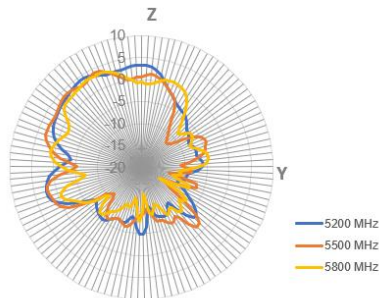
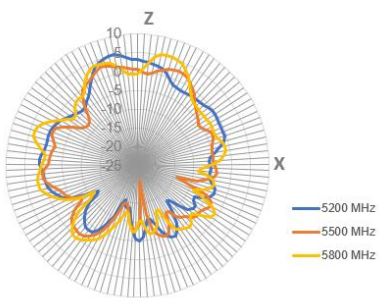

4.4 GNSS 3D and 2D Radiation Patterns

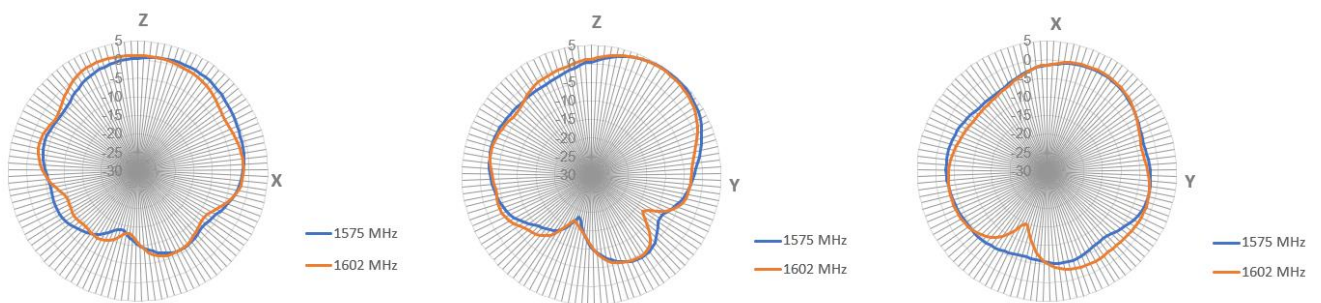
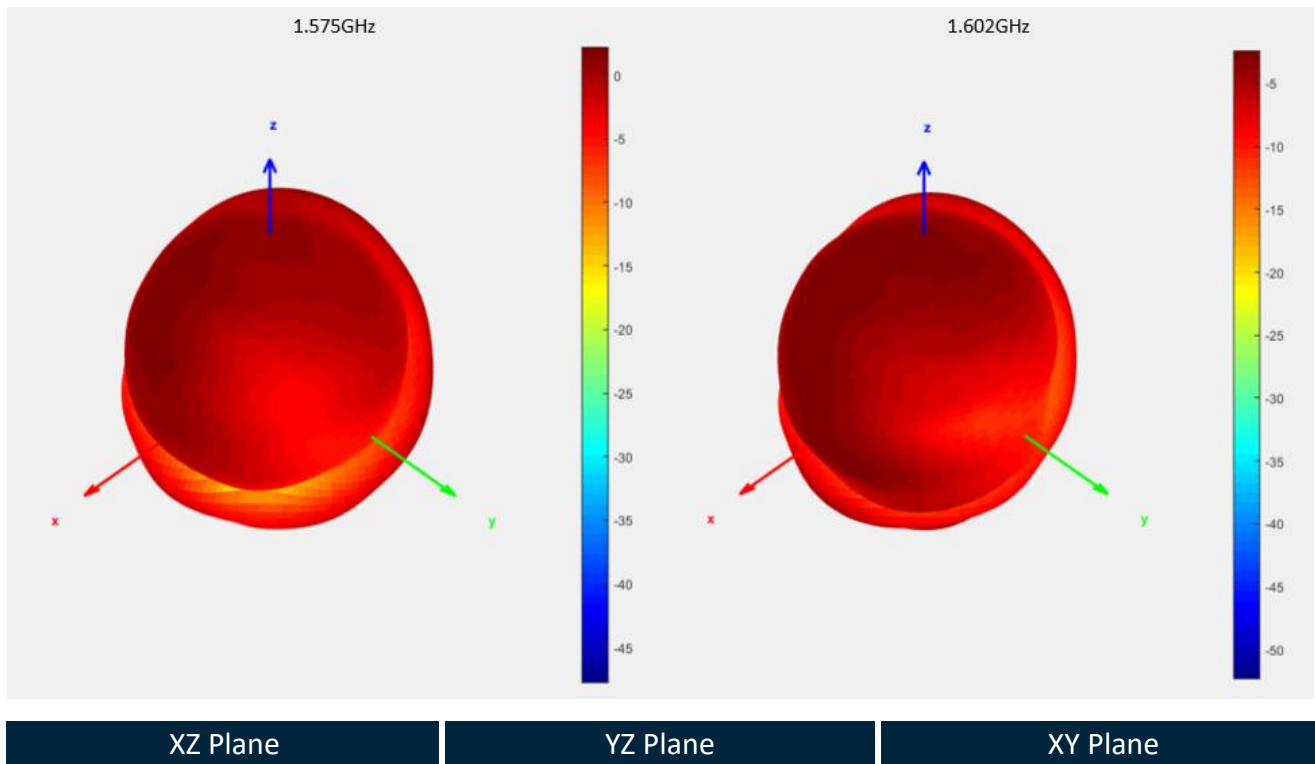

# 5. Mechanical Drawing

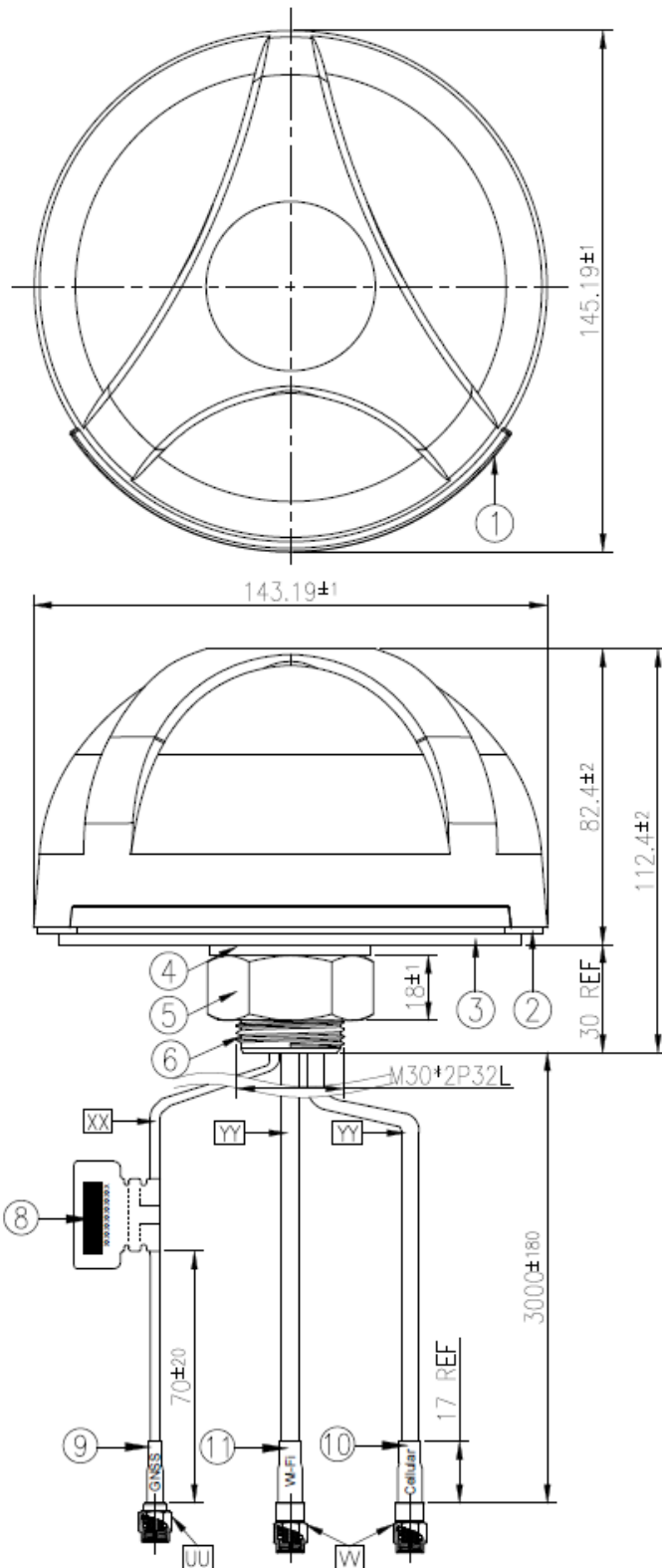

Bottom Thread View

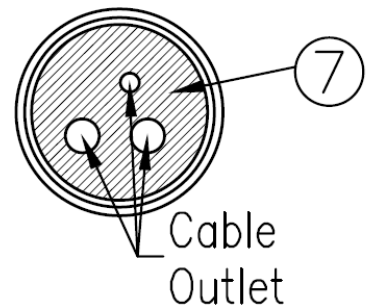

	Name	Material	Finish	QTY
1	Housing	PC 540	White	1
2	Closed Cell Foam	CR 4305	Black	1
3	3M Double Adhesive	3M 9448 HK	White Liner	1
4	M30 Nut	Steel AISI 1215	Ni Plated	1
5	Washer	Steel AISI 1215	Ni Plated	1
6	M30x 2 Thread 32L	Zinc Alloy	Ni Plated	1
7	Waterproof Gasket	Silicon Rubber	White	1
8	GPS-Glonass Label	Coated Paper	Orange	1
9	2.4/5 GHz Label	Coated Paper	Green	1
10	Cellular Label	Coated Paper	Blue	1
11	Heat Shrink Tube(RG-174)	PE	Black	1
12	Rubber Stopper	Silicone Rubber	Black	1
13	Heat Shrink Tube(CFD200)	PE	Black	2

	Name	Spec	Finish	QTY
UU	Connector Type	SMA(M) ST	Gold	1
VV	Connector Type	SMA(M) ST	Gold	2
WW	Cable Length	300±30mm	Black	1
XX	Cable Type	RG174	Black	1
YY	Cable Type	CFD 200	Black	2

## 6. Installation

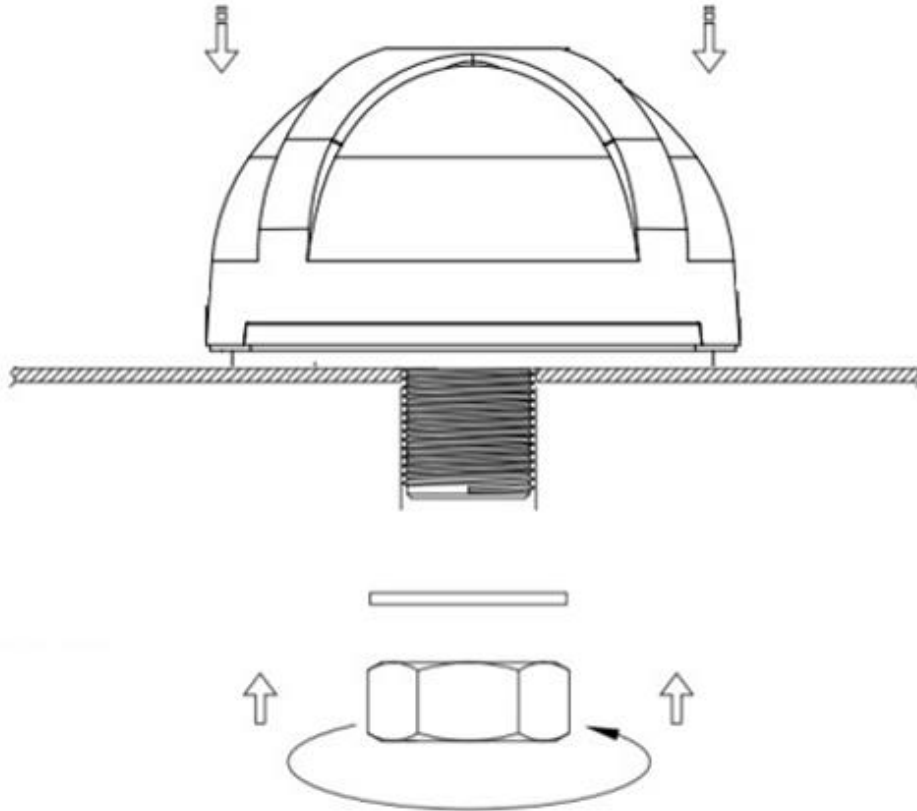

**Recommended torque for mounting: 5-7Nm**

*(Torque value obtained with antenna mounted on 1mm thick SUS-316 bracket)*

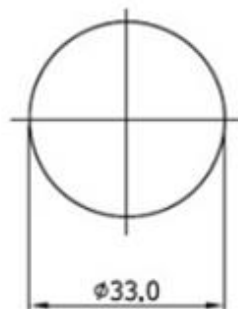

**Reccommended  
Mounting Hole**

**Unit:mm**

## 7. Packaging

1pc MA700.W.A.ABC.001 per box  
 Box Dimensions – 185 x 170 x 177mm  
 Weight – 1.53Kg

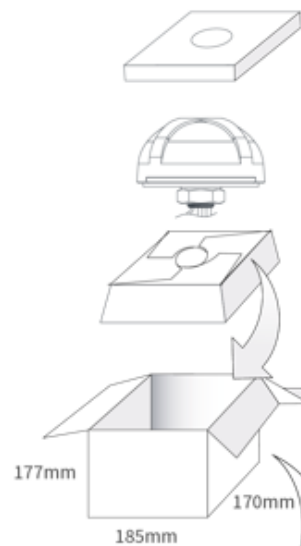

8pcs MA700.W.A.ABC.001 per Carton  
 Carton Dimensions – 384 x 350 x 388mm  
 Weight – 12.24Kg

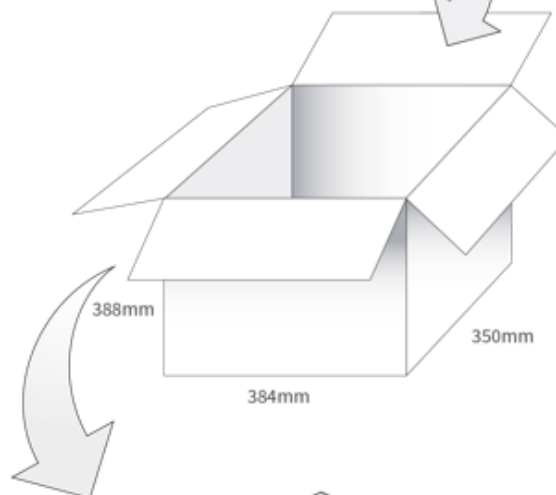

32 Cartons per pallet  
 Pallet Dimensions – 1100 x 1100mm

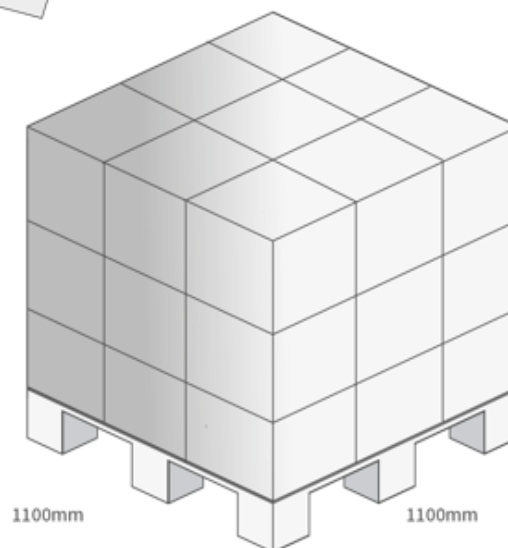

Changelog for the datasheet

**SPE-12-8-089 – MA700.W.A.ABC.001**

**Revision: E (Current Version)**

Date:	2021-11-16
Changes:	Rebranded as 5G, updated datasheet template to new template & updated installation guide torque values.
Changes Made by:	Gary West

**Previous Revisions**

**Revision: D**

Date:	2017-04-04
Changes:	LTE Band Table
Changes Made by:	Peter Monahan

**Revision: C**

Date:	2013-11-07
Changes:	Added GPS/GLONASS
Changes Made by:	Aine Doyle

**Revision: B**

Date:	2012-09-13
Changes:	
Changes Made by:	

**Revision: A (Original First Release)**

Date:	2012-07-17
Notes:	
Author:	



**TAOGLAS®**

[www.taoglas.com](http://www.taoglas.com)

