

- ▼ Simple Drive Requirement
- ▼ Small Size & Lower Profile
- ▼ RoHS Compliant & Halogen-Free

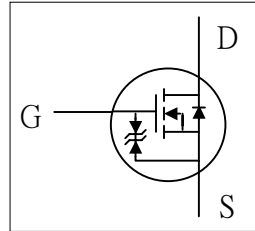

| | |
|--------------|---------------|
| BV_{DSS} | 30V |
| $R_{DS(ON)}$ | 4.5m Ω |
| I_D | 20.7A |

Description

XP4024 series are innovated design and silicon process technology to achieve the lowest possible on-resistance and fast switching performance. It provides the designer with an extreme efficient device for use in a wide range of power applications.

The PMPAK[®] 3x3 package is special for voltage conversion application using standard infrared reflow technique with the backside heat sink to achieve the good thermal performance.

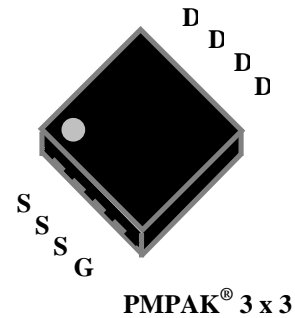

Absolute Maximum Ratings @T_j=25°C (unless otherwise specified)

| Symbol | Parameter | Rating | Units |
|------------------------|--------------------------------------|------------|------------|
| V_{DS} | Drain-Source Voltage | 30 | V |
| V_{GS} | Gate-Source Voltage | ± 20 | V |
| $I_D @ T_A=25^\circ C$ | Drain Current, $V_{GS} @ 10V^3$ | 20.7 | A |
| $I_D @ T_A=70^\circ C$ | Drain Current, $V_{GS} @ 10V^3$ | 16.5 | A |
| I_{DM} | Pulsed Drain Current ¹ | 80 | A |
| $P_D @ T_A=25^\circ C$ | Total Power Dissipation | 3.12 | W |
| T_{STG} | Storage Temperature Range | -55 to 150 | $^\circ C$ |
| T_J | Operating Junction Temperature Range | -55 to 150 | $^\circ C$ |

Thermal Data

| Symbol | Parameter | Value | Unit |
|--------|---|-------|--------------|
| Rthj-c | Maximum Thermal Resistance, Junction-case | 5 | $^\circ C/W$ |
| Rthj-a | Maximum Thermal Resistance, Junction-ambient ³ | 40 | $^\circ C/W$ |

Electrical Characteristics @T_j=25°C(unless otherwise specified)

| Symbol | Parameter | Test Conditions | Min. | Typ. | Max. | Units |
|---------------------|--|--|------|------|------|-------|
| BV _{DSS} | Drain-Source Breakdown Voltage | V _{GS} =0V, I _D =250uA | 30 | - | - | V |
| R _{DS(ON)} | Static Drain-Source On-Resistance ² | V _{GS} =10V, I _D =20A | - | 3.6 | 4.5 | mΩ |
| | | V _{GS} =4.5V, I _D =12A | - | 5.2 | 8.5 | mΩ |
| V _{GS(th)} | Gate Threshold Voltage | V _{DS} =V _{GS} , I _D =250uA | 1.2 | 1.6 | 2.5 | V |
| g _{fs} | Forward Transconductance | V _{DS} =10V, I _D =20A | - | 70 | - | S |
| I _{DSS} | Drain-Source Leakage Current | V _{DS} =24V, V _{GS} =0V | - | - | 10 | uA |
| I _{GSS} | Gate-Source Leakage | V _{GS} =±20V, V _{DS} =0V | - | - | ±30 | uA |
| Q _g | Total Gate Charge | I _D =12A | - | 15 | 24 | nC |
| Q _{gs} | Gate-Source Charge | V _{DS} =15V | - | 4 | - | nC |
| Q _{gd} | Gate-Drain ("Miller") Charge | V _{GS} =4.5V | - | 7 | - | nC |
| t _{d(on)} | Turn-on Delay Time | V _{DS} =15V | - | 14 | - | ns |
| t _r | Rise Time | I _D =1A | - | 10 | - | ns |
| t _{d(off)} | Turn-off Delay Time | R _G =6Ω | - | 33 | - | ns |
| t _f | Fall Time | V _{GS} =10V | - | 18 | - | ns |
| C _{iss} | Input Capacitance | V _{GS} =0V | - | 1500 | 2400 | pF |
| C _{oss} | Output Capacitance | V _{DS} =15V | - | 320 | - | pF |
| C _{rss} | Reverse Transfer Capacitance | f=1.0MHz | - | 210 | - | pF |
| R _g | Gate Resistance | f=1.0MHz | - | 1.2 | 2.4 | Ω |

Source-Drain Diode

| Symbol | Parameter | Test Conditions | Min. | Typ. | Max. | Units |
|-----------------|---------------------------------|---|------|------|------|-------|
| V _{SD} | Forward On Voltage ² | I _S =2.9A, V _{GS} =0V | - | - | 1.2 | V |
| t _{rr} | Reverse Recovery Time | I _S =20A, V _{GS} =0V, | - | 20 | - | ns |
| Q _{rr} | Reverse Recovery Charge | di/dt=100A/μs | - | 5 | - | nC |

Notes:

- 1.Pulse width limited by Max. junction temperature.
- 2.Pulse test
- 3.Surface mounted on 1 in² 2oz copper pad of FR4 board, t ≤10sec; 210°C/W when mounted on min. copper pad.

THIS PRODUCT IS SENSITIVE TO ELECTROSTATIC DISCHARGE, PLEASE HANDLE WITH CAUTION.

USE OF THIS PRODUCT AS A CRITICAL COMPONENT IN LIFE SUPPORT OR OTHER SIMILAR SYSTEMS IS NOT AUTHORIZED.

XSEMI DOES NOT ASSUME ANY LIABILITY ARISING OUT OF THE APPLICATION OR USE OF ANY PRODUCT OR CIRCUIT DESCRIBED HEREIN; NEITHER DOES IT CONVEY ANY LICENSE UNDER ITS PATENT RIGHTS, NOR THE RIGHTS OF OTHERS.

XSEMI RESERVES THE RIGHT TO MAKE CHANGES WITHOUT FURTHER NOTICE TO ANY PRODUCTS HEREIN TO IMPROVE RELIABILITY, FUNCTION OR DESIGN.

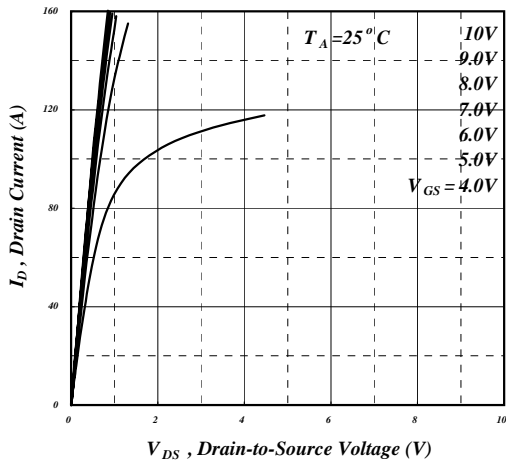

Fig 1. Typical Output Characteristics

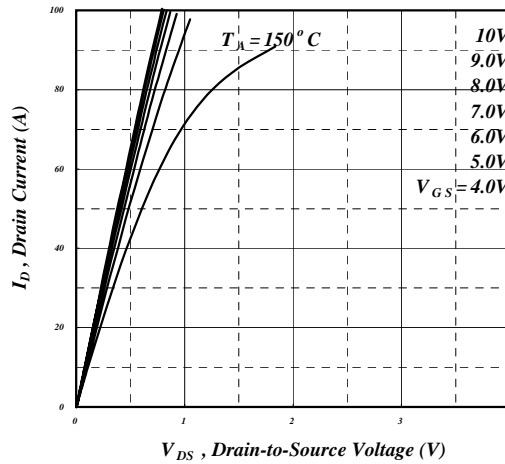

Fig 2. Typical Output Characteristics

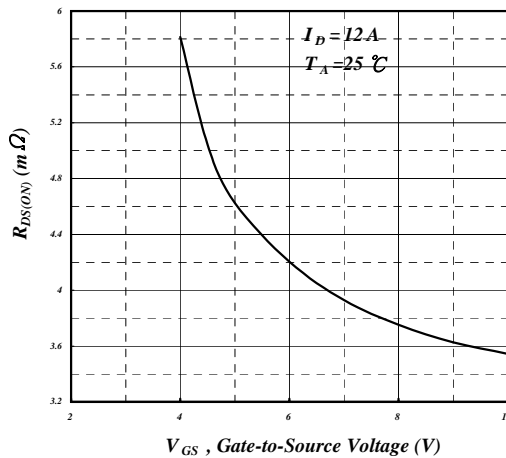

Fig 3. On-Resistance v.s. Gate Voltage

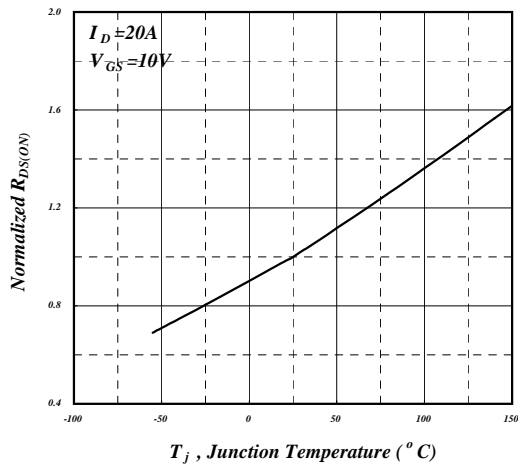

Fig 4. Normalized On-Resistance v.s. Junction Temperature

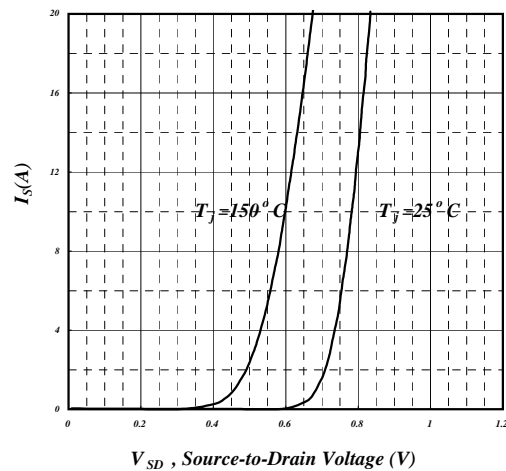

Fig 5. Forward Characteristic of Reverse Diode

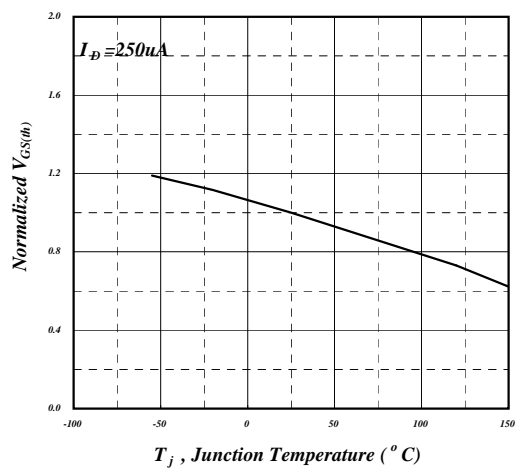

Fig 6. Gate Threshold Voltage v.s. Junction Temperature

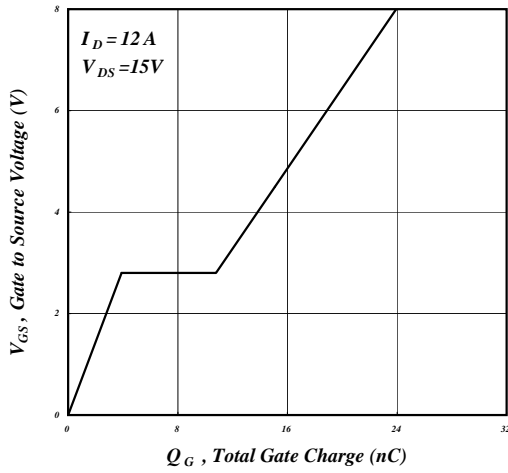

Fig 7. Gate Charge Characteristics

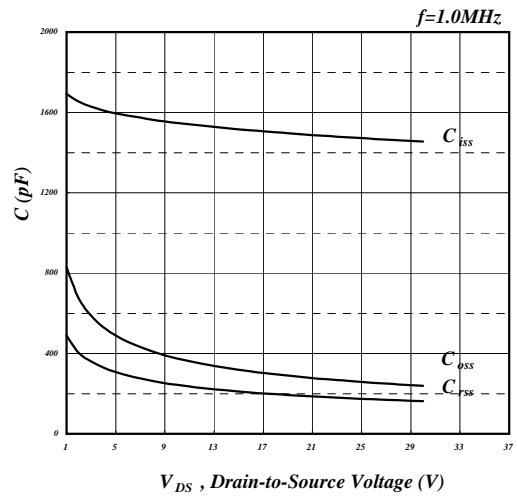

Fig 8. Typical Capacitance Characteristics

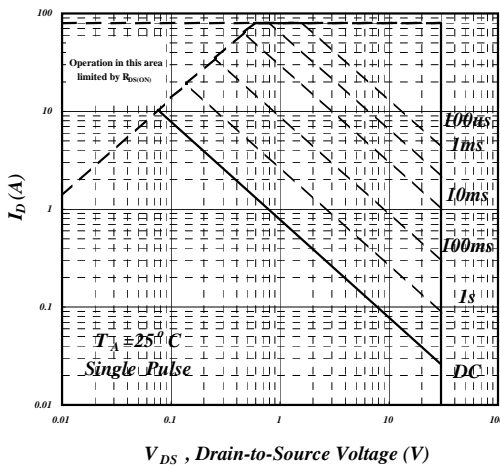

Fig 9. Maximum Safe Operating Area

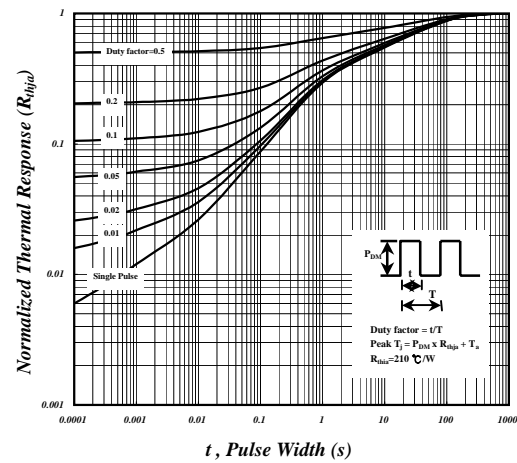

Fig 10. Effective Transient Thermal Impedance

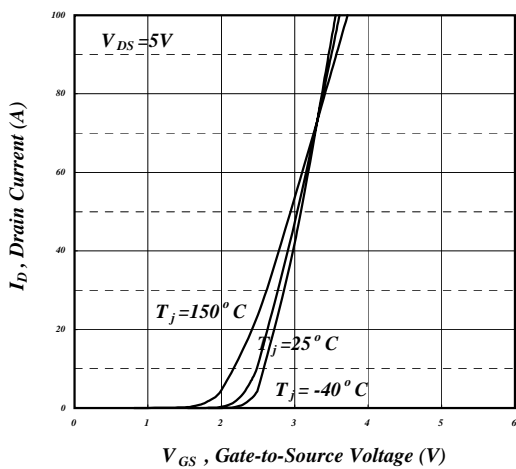

Fig 11. Transfer Characteristics

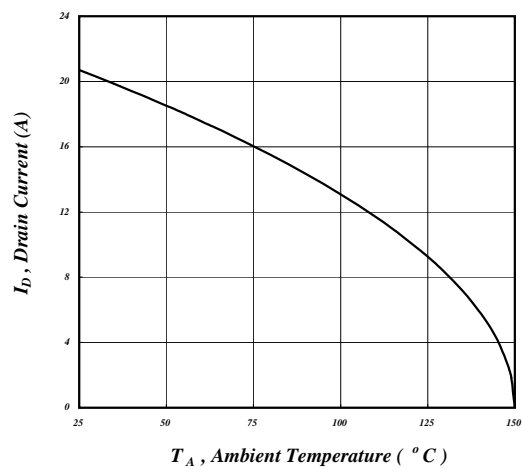

Fig 12. Drain Current v.s. Ambient Temperature

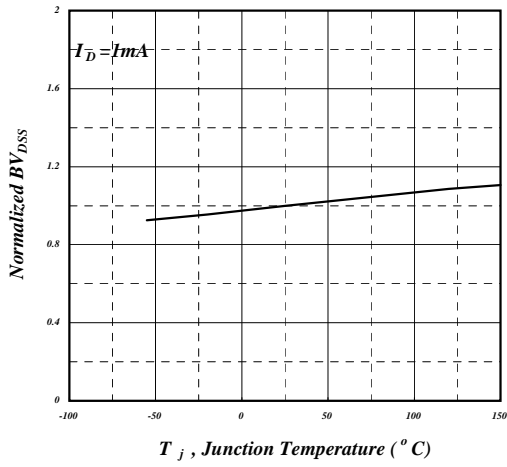

Fig 13. Normalized BV_{DSS} v.s. Junction Temperature

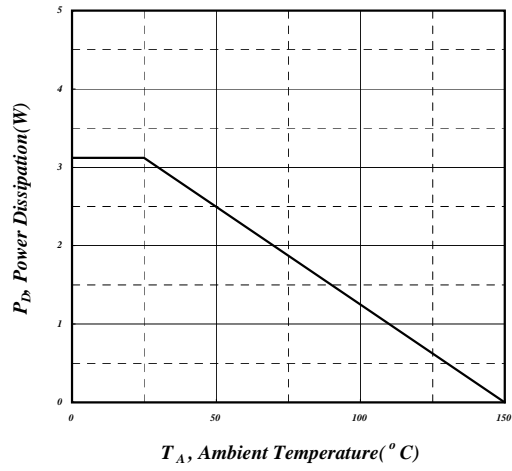

Fig 14. Total Power Dissipation

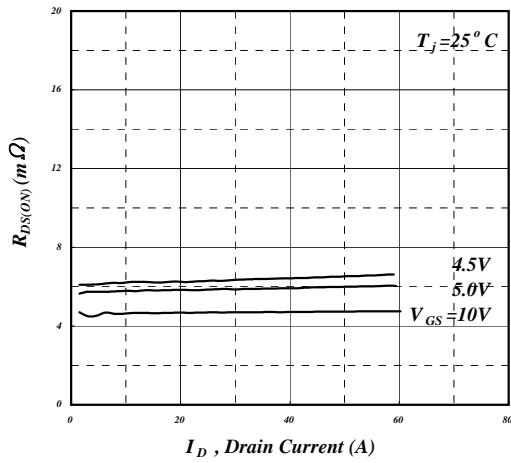
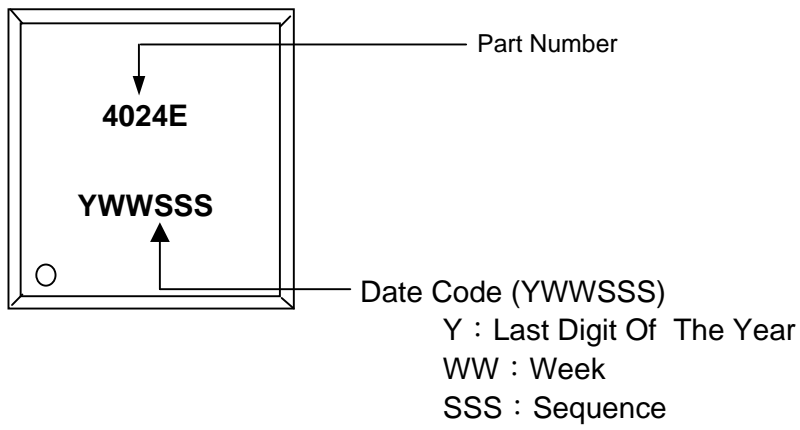
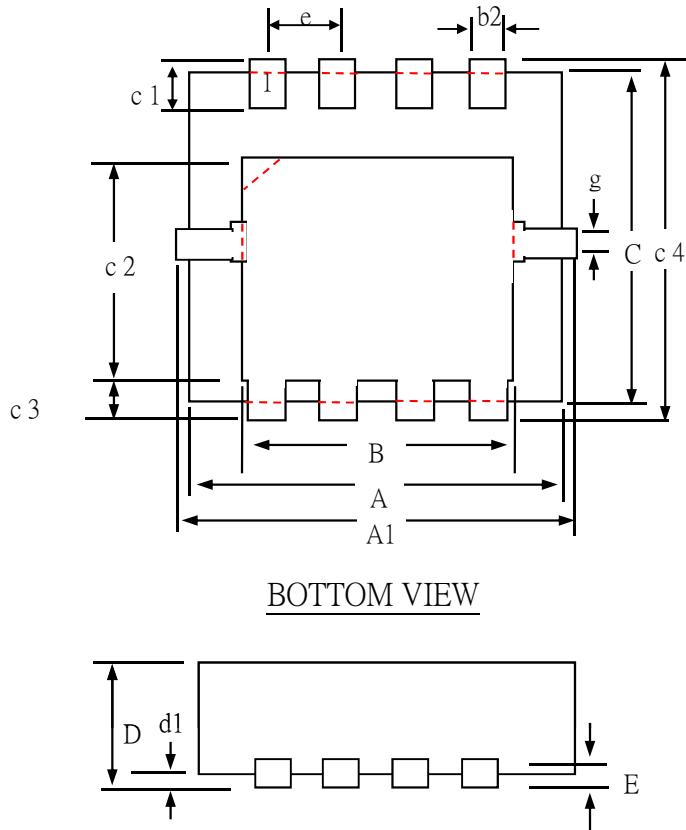

Fig 15. Typ. Drain-Source on State Resistance

MARKING INFORMATION



Package Outline : PMPAK 3x3



| SYMBOLS | Millimeters | | |
|---------|-------------|------|-------|
| | MIN | NOM | MAX |
| A | 2.90 | 3.10 | 3.40 |
| B | 2.20 | 2.45 | 2.80 |
| e | 0.60 | 0.65 | 0.70 |
| b2 | 0.20 | 0.30 | 0.40 |
| C | 2.90 | 3.10 | 3.40 |
| c1 | 0.10 | 0.30 | 0.50 |
| c2 | 1.20 | 1.70 | 2.20 |
| c3 | 0.10 | 0.38 | 0.65 |
| D | 0.65 | 0.80 | 1.05 |
| d1 | 0.00 | 0.10 | 0.20 |
| E | 0.10 | 0.18 | 0.25 |
| A1 | 2.900 | 3.30 | 3.600 |
| c4 | 2.900 | 3.30 | 3.600 |
| g | 0.20 (ref) | | |

1. All Dimension Are In Millimeters.
2. Dimension Does Not Include Mold Protrusions.
3. Thermal PAD and Pin contour is for reference, it may has little difference by option.

PMPAK3X3 FOOTPRINT :

