

EZ-LIGHT® K50 Beacon

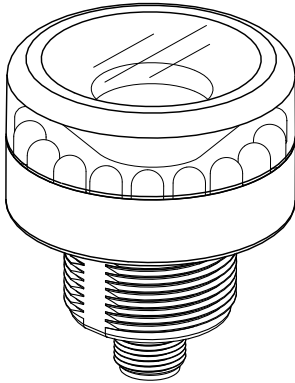

Daylight-visible, general-purpose indicators for indoor or outdoor use

For the latest technical information about this product, including specifications, dimensions, and wiring, see www.BannerEngineering.com/K50_Beacon



- Intense levels of light output for areas with high ambient light — even outdoors
- Viewable around entire perimeter; some models also emit light from top
- 1- or 2-color models available
- Rugged, sealed thermoplastic housing rated for IP67 and IP69K
- Cabled and quick-disconnect models available
- 12 to 30V dc or 85 to 130V ac (75 to 120V dc) operation, depending on model
- 12V dc operation useful for applications on mobile vehicles
- Consult factory for models with strobing capability

Models

Model		Connection*	LED Color(s)	Input Voltage
Perimeter View Only	Perimeter + Top View			
K50BLXGXPQ	K50BCLXGXPQ	4-pin Euro integral QD connector	Green	12 to 30V dc
K50BLRXRPQ	K50BCLRXRPQ		Red	
K50BLXYXPQ	K50BCLXYXPQ		Yellow	
K50BLXBPQ	K50BCLXBPQ		Blue	
K50BLGRXPQ	K50BCLGRXPQ		Green / Red	
K50BLGA120Q	N.A.	3-pin Micro integral QD connector	Green	85 to 130V ac or 75 to 120V dc
K50BLRA120Q	N.A.		Red	
K50BLYA120Q	N.A.		Yellow	
K50BLWA120Q	N.A.		White	
K50BLBA120Q	N.A.		Blue	

* Integral QD models only are listed.

- For 150 mm PVC pigtail with QD, replace **Q** with **QP** in model number (example, **K50BLXGXPQP**).
- For 2 m (6.5') cable, omit suffix **Q** from model number (example, **K50BLXGXP**).
- A model with a QD requires a mating cable (see [Accessory Cordsets](#) on page 4).



WARNING: Not To Be Used for Personnel Protection

Never use this product as a sensing device for personnel protection. Doing so could lead to serious injury or death. This product does NOT include the self-checking redundant circuitry necessary to allow its use in personnel safety applications. A sensor failure or malfunction can cause either an energized or de-energized sensor output condition.



Specifications

Supply Voltage and Current

DC models

12-30V dc

K50BL 1-color models: 140 mA max. @ 12V dc, 70 mA max. @ 30V dc

K50BCL 1-color models: 160 mA max. @ 12V dc, 80 mA max. @ 30V dc

K50BL 2-color models, per color: 75 mA max. @ 12V dc, 40 mA max. @ 30V dc

K50BCL 2-color models, per color: 95 mA max. @ 12V dc, 40 mA max. @ 30V dc

AC models

85 to 130V ac or 75 to 120V dc @ 16 mA max.

Supply Protection Circuitry

Protected against reverse polarity and transient voltages

Indicators

LED colors are independently selected, depending on model

Indicator Power-up Response Time

DC models

ON: 10 ms; OFF: 7 ms

AC models

ON/OFF: 500 μ s

Environmental Rating

Rated IEC IP67 and IP69K, per DIN 40050

Construction

Base and covers: polycarbonate

Connections

Integral 4-pin Euro-style (dc models) 3-pin Micro-style (ac models) QD or 2 m (6.5') integral cable, depending on model

Operating Conditions

-40° to +50° C (-40° to +122° F)

90% @ 50° C max. relative humidity (non-condensing)

Vibration and Mechanical Shock

All models meet Mil. Std. 202F requirements method 201A (vibration: 10 to 60 Hz max., double amplitude 0.06", maximum acceleration 10G). Also meets IEC 947-5-2; 30G 11 ms duration, half sine wave.

Certifications

Approvals are pending

Application Note

Light emits 360° from housing sides and from housing top, some models

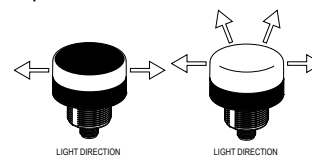

Dimensions

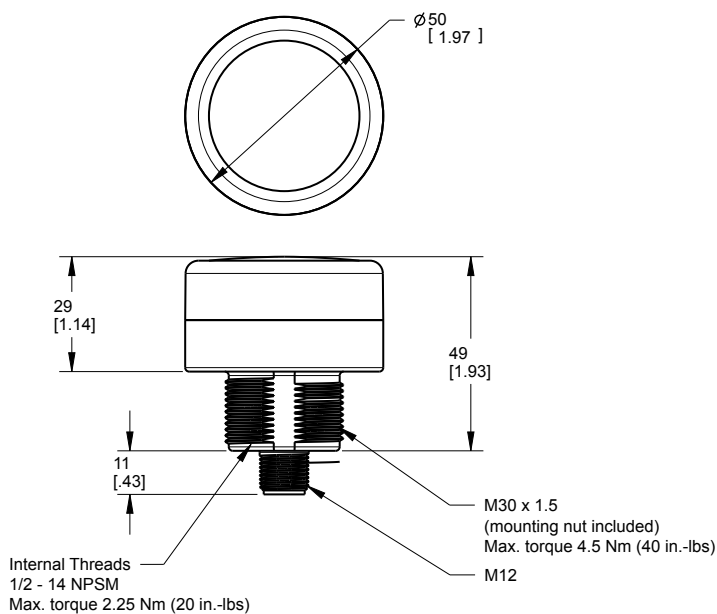

Wiring — DC Models

1-Color Models (PNP/NPN Selectable)			
Sourcing (PNP) Input	Sinking (NPN) Input	Pinout	Wiring Key:
			1 = Brown 2 = White 3 = Blue 4 = Black C = Indicator color X = Not used

2-Color Models			
Sourcing (PNP) Input	Pinout	Wiring Key:	
		1 = Brown 2 = White 3 = Blue 4 = Black C1 = Indicator color 1 C2 = Indicator color 2 X = Not used	

Wiring — AC Models

Quick-Disconnect (QD) Models	Cabled Models
<p>Wiring Key: 1 = Green (not used) 2 = Red/Black 3 = Red/White</p>	<p>Wiring Key: 1 = Black 3 = White</p>

Accessory Cordsets

4-Pin Euro-Style Cordsets

4-Pin M12/Euro-Style Cordsets (straight connector) MQDC-406 , 2 m (6.5') MQDC-415 , 5 m (15') MQDC-430 , 9 m (30')	4-Pin M12/Euro-Style Cordsets (right-angle connector) MQDC-406RA , 2 m (6.5') MQDC-415RA , 5 m (15') MQDC-430RA , 9 m (30')
---------------------------------------------------------------------------------------------------------------------------------------------------------	------------------------------------------------------------------------------------------------------------------------------------------------------------------

3-Pin Micro-Style Cordsets

3-Pin M12/Micro-Style Cordsets (straight connector) MQDC-306 , 2 m (6.5') MQDC-315 , 5 m (15') MQDC-330 , 9 m (30')	3-Pin M12/Micro-Style Cordsets (right-angle connector) MQDC-306RA , 2 m (6.5') MQDC-315RA , 5 m (15') MQDC-330RA , 9 m (30')
----------------------------------------------------------------------------------------------------------------------------------------------------------	-------------------------------------------------------------------------------------------------------------------------------------------------------------------

Accessory Mounting Brackets

For further bracket information, see the Banner catalog or www.BannerEngineering.com

SMB30SC

- 30 mm split clamp with swivel, black reinforced thermoplastic polyester
- Stainless steel hardware included

SMB30MM

- 30 mm, 11-gauge, stainless steel bracket with curved mounting slots for versatile orientation
- Clearance for M6 (1/4") hardware



SMB30A

- Right-angle bracket with curved slot for versatile orientation
- Clearance for M6 (1/4") hardware
- 30 mm mounting hole
- 12-ga. stainless steel

SMB30FA

- Swivel bracket with tilt and pan movement for precision adjustment
- 30 mm mounting hole
- 12-ga. 304 stainless steel

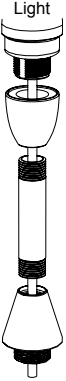
Elevated Mount System

Model		Features	Components	
SA-M30E12		<ul style="list-style-type: none"> Streamlined acetal stand-off pipe adapter/cover Connects between 30 mm light base and ½" NPSM/DN15 pipe Mounting hardware included 		
Stainless Steel	Aluminum	<ul style="list-style-type: none"> Elevated-use stand-off pipe (½" NPSM/DN15) Polished 304 stainless steel or black anodized aluminum surface ½ NPT thread at both ends Compatible with most industrial environments 		
SOP-E12-150SS 150 mm (6") long	SOP-E12-150A 150 mm (6") long			
SOP-E12-300SS 300 mm (12") long	SOP-E12-300A 300 mm (12") long			
SOP-E12-900SS 900 mm (36") long	SOP-E12-900A 900 mm (36") long			
SA-E12M30		<ul style="list-style-type: none"> Streamlined acetal mounting base adapter/cover Connects between ½" NPSM/DN15 pipe and 30 mm (1-3/16") drilled hole Mounting hardware included 		

Contact Us

For more information: Contact your local Banner representative or Banner Corporate Offices around the world.

Corporate Headquarters: Banner Engineering Corp. 9714 Tenth Ave. North, Mpls., MN 55441, Tel: 763-544-3164, www.bannerengineering.com, sensors@bannerengineering.com

Europe: Banner Engineering Europe Park Lane, Culliganlaan 2F, Diegem B-1831 BELGIUM, Tel: 32-2 456 07 80, Fax: 32-2 456 07 89, www.bannereurope.com, mail@bannereurope.com

Latin America: Contact Banner Engineering Corp. (US) or e-mail **Mexico:** mexico@bannerengineering.com; or **Brazil:** brasil@bannerengineering.com

Asia:

Banner Engineering China Shanghai Rep Office Rm. G/H/I, 28th Flr. Cross Region Plaza No. 899, Lingling Road, Shanghai 200030 CHINA, Tel: 86-21-54894500, Fax: 86-21-54894511, www.bannerengineering.com.cn, sensors@bannerengineering.com.cn

Banner Engineering Japan Cent-Urban Building 305 3-23-15, Nishi-Nakajima Yodogawa-Ku, Osaka 532-0011 JAPAN, Tel: 81-6-6309-0411, Fax: 81-6-6309-0416, www.bannerengineering.co.jp, mail@bannerengineering.co.jp

Banner Engineering Asia — Taiwan Neihu Technology Park 5F-1, No. 51, Lane 35, Jihu Rd., Taipei 114 TAIWAN, Tel: 886-2-8751-9966, Fax: 886-2-8751-2966, www.bannerengineering.com.tw, info@bannerengineering.com.tw

Banner Engineering India Pune Head Quarters Office, No. 1001 Sai Capital, Opp. ICC Senapati Bapat Road, Pune 411016 INDIA, Tel: 91-20-66405624, Fax: 91-20-66405623, www.bannerengineering.co.in, india@bannerengineering.com



Warranty: Banner Engineering Corporation warrants its products to be free from defects for a period of one year. Banner Engineering Corporation will repair or replace, free of charge, any product of its manufacture found to be defective at the time it is returned to the factory during the warranty period. This warranty does not cover damage or liability for the improper application of Banner products. This warranty is in lieu of any other warranty either expressed or implied.